

CROWN

# STACKER SERIES



# Productivity That Pays Every Day

The Crown Stacker Series provides efficient solutions to lift, stack, move and manage product. A versatile Crown stacker can maneuver in small spaces, stack pallet loads to better utilize space and improve productivity throughout your operation.



The flexible, ergonomic design of the **X10® Handle** allows the operator to access the controls from either side of the power unit, providing a clearer view and greater maneuverability.

## Space Savings

Crown stackers are an easy and cost-effective solution to help save space and improve efficiency. Unlike rider counterbalance trucks that require 11 to 12 foot aisles, Crown stackers allow you to use narrower 6 to 11 foot aisles so you can stack more product in the same space, while improving selectivity and workflow.

Crown electric stackers are efficient, require less maintenance and avoid pollutants, fuel cost and engine noise compared to IC powered fork lifts.

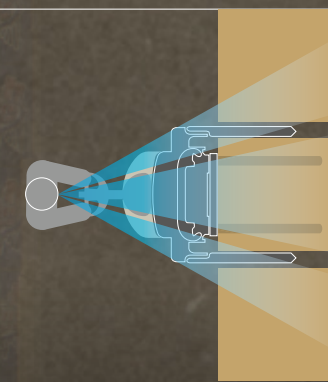
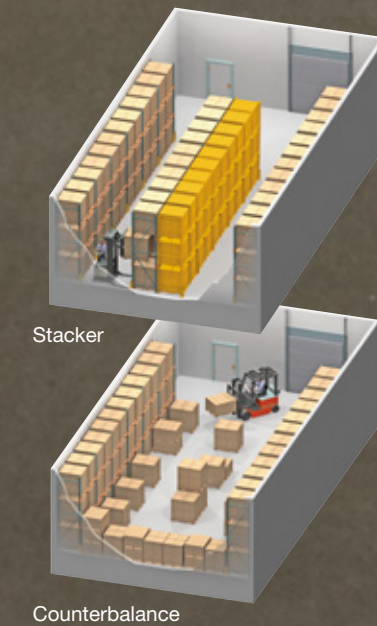

Load pickup and positioning is enhanced with excellent visibility of the outrigger on straddle stacker models.

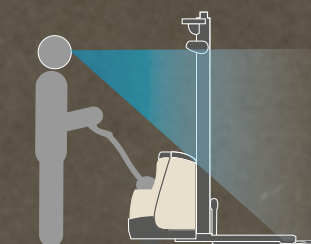

The sloped, low-profile power unit cover and open mast design provide excellent fork tip visibility for pallet entry and exit.

Crown offers a wide range of stacker options to provide the right solution for your operation. Standard features like power steering on all models enhance operability, while unique design characteristics, capabilities and options of each model can help address specific applications and challenges. Review our stacker series to help determine which model is best suited for your application.



Stacker Series	M 3200	ST 3200	SX 3200	SH 5500	SHR 5500	SHC 5500	ES 4000
Capacity	2,000 lb	2,500 lb	3,000 lb 4,000 lb	4,000 lb	2,500 lb 3,000 lb 3,500 lb	2,500 lb 3,000 lb 4,000 lb	3,500 lb
Lift Height	90-144 in	128-168 in	128-192 in	127-192 in	127-192 in	114-172 in	128-132 in
Aisle Width	6-7 ft	6-7 ft	6-7 ft	6.5-7.5 ft	7-9 ft	9-11 ft	6-7 ft

Crown stackers give operators precise control to handle the task at hand. When maneuvering a load, position speed control enables operators to use the handle in near vertical position while engaging traction at creep speed. When operating in tight spaces with the handle completely upright, vertical tiller drive allows for fine-tuned pallet positioning.

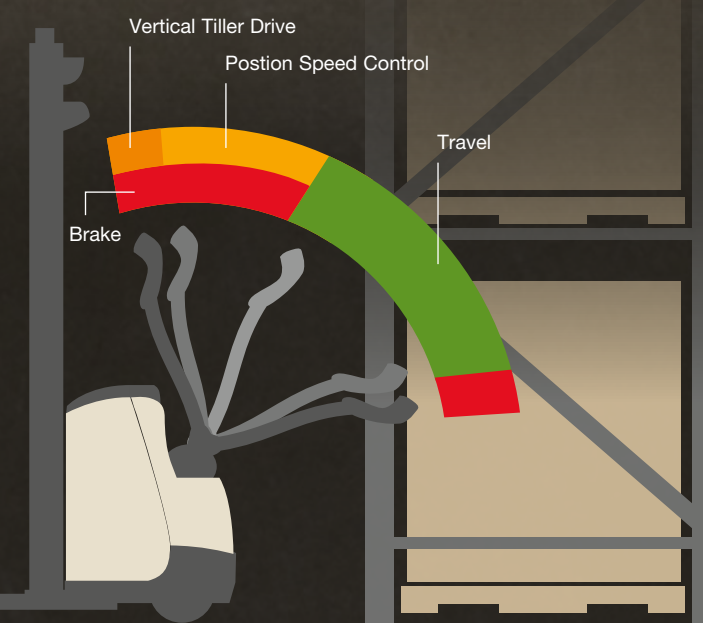

Position Speed Control feature does not apply to the SH, SHR, SHC, and ES. These models feature Brake Override.



# Straddle Stackers

Straddle stackers are known for making a big impact with a smaller footprint, helping operators store and retrieve heavy loads while maneuvering in narrow aisles. Their durable construction, combined with tremendous versatility, make them an ideal solution for many operations.



**M**

**Capacity:**  
2,000 lb  
**Lift heights:**  
90 in to 144 in



**ST**

**Capacity:**  
2,500 lb  
**Lift heights:**  
128 in to 168 in



**SX**

**Capacity:**  
3,000 lb, 4,000 lb  
**Lift heights:**  
128 in to 192 in



**SH**

**Capacity:**  
4,000 lb  
**Lift heights:**  
127 in to 192 in

## Simplify Load Positioning and Placement



Operators find straddle stackers easy to use when stacking vertically on a rack system. The ease of maneuverability simplifies load positioning and placement.



Straddle stackers can also be used to simplify loading and unloading when making deliveries where docks may not be available.

**Straddle Stacker Turning Radius**



**Counterbalance Turning Radius**

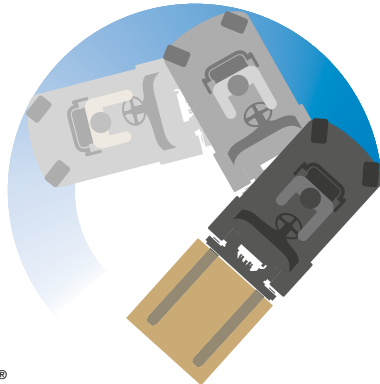

With the advantages of brake override maneuverability, AC traction and automatic speed control managed by Access 1 2 3<sup>®</sup> technology, Crown stackers provide a significantly tighter turn radius than typical rider counterbalance lift trucks.





## Reach Stacker

The wide range of benefits offered by the SHR Series includes exceptional flexibility to solve tough application challenges. It provides an efficient solution for tight work areas and various pallet sizes as well as loads that may be out of reach of other lift trucks.

### Operators benefit from:

- High-visibility mast design featuring efficient placement of hydraulics and lift cylinders
- Improved load handling and positioning at height
- Simplified charging with optional on-board charger that connects into a standard electrical outlet

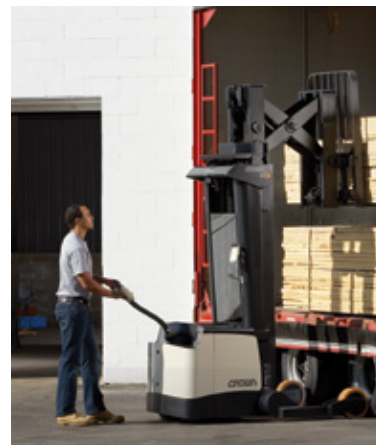

#### SHR

**Capacity:**  
2,500 lb, 3,000 lb, 3,500 lb

**Lift heights:**  
127 to 192 in



## Counterbalance Stacker

The SHC offers exceptional sightlines directly to the fork tips, which improves load handling and positioning at floor level and at height.

The SHC 5500 is a counterbalanced stacker, providing stability without the need for outriggers. This versatile lift truck is also available with optional attachments, making it ideal for trailer loading/unloading, dock work, put-away, block stacking and short transport.

#### SHC

**Capacity:**  
2,500 lb, 3,000 lb, 4,000 lb

**Lift heights:**  
114 to 172 in



# Fork Over Stacker

Crown's ES 4000 Series Fork Over Stacker is designed to provide operators with excellent visibility and precise control. Outriggers aligned directly under the forks allow for industrial wire bins and storage totes to be handled with ease. Strength is apparent with the ES 4000, proving that compact does not have to be light duty.

## ES

**Capacity:**  
3,500 lb

**Lift heights:**  
128 in to 132 in



## Ergonomic Solutions, Greater Productivity

Crown stackers are also useful as portable workstations, enabling workers to precisely position work at the proper height and location to reduce the risk of injury and improve productivity and comfort.



## Crown Options and Accessories

A full line of options and accessories are available for the Crown Stacker Series to help meet the requirements of your dynamic business and achieve your goals.



Work Assist® accessories



Wire mesh (Plexiglass also available)



Keyless on/off



Freezer conditioning



30 amp on-board charger



V-Force® Industrial charger

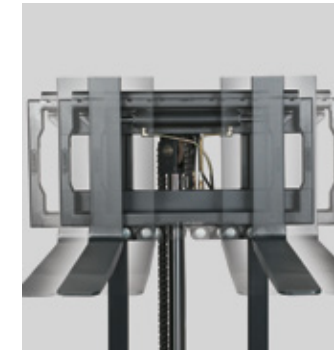

Integrated sidsheft



Load backrest



Drive tire(s)



Industrial battery



Battery pack



InfoLink® Operator & Fleet Management



Spring-loaded casters

Not all accessories are available on every stacker. To learn more visit [crown.com](http://crown.com).

# High Dependability

## Low Total Cost

Tough, Crown-built components are key to providing strength and durability to our reliable stacker lineup, and ensuring performance and uptime to reduce the total cost of ownership.



The steel frame and covers provide solid protection to internal components, while still allowing quick and generous access for serviceability.



### Access123®

This exclusive Crown technology enables safe and reliable lift truck performance and diagnostics through an intuitive method of communication, while giving operators advanced, optimized control.



## Crown's Proven Support Network

Crown support begins long before a lift truck leaves the factory. Our integrated approach to service provides a time-tested user experience to our customers—before, during and after the sale.

#### Safety and Training

Our comprehensive training programs for operators, supervisors, technicians—and even pedestrians—can help support your efforts to provide a safe and productive work environment. Our DP TrainSafe® Train-the-Trainer program offered locally can provide your organization with tools to efficiently train new operators using your own resources. At our Regional Training Centers, DP Service Technician Training goes above and beyond traditional classroom training, allowing participants to work on lift trucks with instructor supervision.



#### Forklift Maintenance and Repair

Crown's Integrity Service System® keeps your forklifts running—regardless of brand. From time and material to complete maintenance, our Integrity Service System offers a variety of service plans to suit your needs in the most efficient and cost-effective way. Our well-stocked, GPS-dispatched service vans ensure your service technician arrives with the right part at the right time.



#### Fleet Management

InfoLink® Fleet and Operator Management puts the power of accurate, on-demand business metrics at your fingertips. When robust data drives confident decisions, your organization can achieve improved results in safety and compliance, higher productivity, lower costs and optimized operations. InfoLink Data Services can help create a solid foundation to help you achieve your goals and provide data integration and other consultative services to continue your journey.



**Put the Stacker Series to Work for You.**  
To learn more visit [crown.com](http://crown.com).

**Visit [crown.com](http://crown.com)**  
See the Stacker Series



**Crown Equipment Corporation**  
New Bremen, Ohio 45869 USA  
**Tel** 419-629-2311  
**Fax** 419-629-3796  
crown.com

**You can count on Crown to build lift trucks designed for safe operation, but that's only part of the safety equation. Crown encourages safe operating practices through ongoing operator training, safety-focused supervision, maintenance and a safe working environment. Go to [crown.com](http://crown.com) and view our safety section to learn more.**

Because Crown is continually improving its products, specifications are subject to change without notice.

Notice: Not all products and product features are available in all countries in which this literature is published.

Crown, the Crown logo, the color beige, the Momentum Mark, Access 1 2 3, InfoLink, Integrity Service System, Work Assist, DP TrainSafe, V-Force, and the ecologic logo are trademarks of Crown Equipment Corporation in the United States and other countries.

Copyright 2013-2023 Crown Equipment Corporation  
SF20415 Rev. 05-23  
Printed in U.S.A.



Clean Environment. Smart Business.

Printed on elemental chlorine free and sustainably forested paper.