



ONE SOURCE CATALOG 2024



Scan the QR code to purchase parts online, or to access a digital version of this catalog.

one[®]
source
LIFT TRUCK PARTS

ONE SOURCE LIFT TRUCK PARTS PROGRAM KEEPS YOUR MIXED FLEET MOVING

Have a mixed fleet of material handling equipment? Count on Crown to keep your fleet moving.

Crown's service technicians are trained through our award winning Demonstrated Performance® Service Training. This training along with Crown's genuine Integrity Parts keep your Crown fleet efficient and well maintained.

Add Crown's One Source program and you'll also have access to more than 50 brands of material handling equipment.



one[®]
source
LIFT TRUCK PARTS

Crown One Source

Contents

Section 1	Service Supplies
Section 2	Safety Equipment
Section 3	Warehouse
Section 4	Electric Truck Components
Section 5	Internal Combustion (IC) Truck Components
Section 6	Work Assist®
Section 7	InfoLink®, PTH 50, Chain, Forks and Attachment Parts
Section 8	Battery and Charger
Section 9	Tools
Section 10	Hydraulic Components
Section 11	Wheels and Tires
Section 12	Crown Operator and Service Training
Section 13	Index

- ▶ **Featured Crown promotional items, available through the Crown Store, listed on reverse side.**



To Order:

Visit us online at
crownstore.crown.com
or call 1-800-298-4708.



C-CP-6577-IP

C-CP-6577-IS

Flexfit Caps

Part Number

C-CP-6577-IP (Parts)

C-CP-6577-IS (Service)

- 92% polyester, 8% spandex
- Stretches to fit a wide variety of head sizes comfortably (6 7/8" - 7 1/2")



S-TK-77900

Scale Models

Part Number

S-TK-6000 (Service Van)

S-TK-77010 (RM)

S-TK-77900 (RC)

S-TK-77250 (SC)

- Model replicas
- Spin cast material
- Durable
- Moveable wheels
- Includes gift box



S-TK-6000



Caplight 2000 Black

Part Number - C-CP-2803

- Includes 2 LEDs with light output 24 Lumens
- Powered by 2 CR2032 batteries, included
- Visibility up to 72 ft.
- Battery life up to 30 hrs.
- Ideal for distance and overhead hands-free lighting
- Velcro closure; 100% cotton



LED Beanie Cap - Black

Part Number - C-CP-4148

- Integrated LED light panel - 4 bright white LED lights with 3 levels of brightness
- Uses 2 button cell batteries, included
- Acrylic knit beanie; hand wash only; remove light panel prior to washing



Silicone Card Holder

Part Number - S-CP-8277

- Attaches to cell phone with adhesion and holds business cards, credit cards, ID cards

Pen

Part Number - S-PN-V-FORCE (V-Force®)

Part Number - S-PN-IS (Service)

- Six-sided twist-action ballpoint has a textured metal grip, metal clip, spirit level, 3"/7cm ruler, small reversible Phillips and flathead screwdriver bit and a capacitive stylus that works with touch screen devices.



Diamond Plate Tumbler

Part Number - S-MG-9210

- 20 oz. Tervis brand tumbler
- 24 hours cold/8 hours hot
- BPA free, splash-proof, easy close lid
- Premium grade copper lined 18/8 stainless steel

Sherpa Vacuum Tumbler

Part Number - S-MG-6621

- 11 oz. double wall construction, vacuum insulated
- Clear, press on lid with slide closure
- Works as a tumbler or drink insulator



Pallet Note Pad

Part Number - S-MC-2690

- Sticky note cube, 2 3/4" x 2 3/4" x 2 3/4"
- Packaged on a mini wooden pallet



Tape Measure

Part Number - S-TL-322369

- 8m/26' tape measure
- SAE and metric markings
- Automatic blade lock for easy use
- Magnetic hook
- Push button retrieval - quick, one finger operation
- 1-year warranty



Pocket Eco-Note Jotter

Part Number - S-PF-7469

- Cardboard cover made from recycled paper
- 3"w x 5"h x 0.25"d
- 60 pages ruled, recycled paper
- Elastic closure, metal ring binding
- Micro-writer pen included



LED Flashlight

Part Number - S-FL-322304

- Pen light
- Metal clip included



Pocket Screwdriver

Part Number - S-TL-2032

- Handy pocket clip
- Easy to change 2-in-1 blade (Flat/Phillips)

Section 1

Service Supplies

Contents

Oils	1.02
Fluids	1.04
Grease	1.06
Cleaners	1.08
Aerosol Lubricants	1.12
Bulk Service Supplies	1.13
Wiper Blades	1.14
Paint	1.15
Paint Area Supplies	1.15
Gloves	1.16
Industrial Wiping Products	1.18
Can Liners	1.21
Cable Ties	1.21
Floor Mats	1.22
Tape/Packaging	1.23
Chemicals	1.24
Repair Filler	1.27
Filter Cross Reference	1.28

New Items:

Wiper Blades - p. 1.14

Nitrile Grip Light Weight Gloves - p. 1.16

Note: 1910.178(q)(5) (1998) of the Occupational Safety and Health Act (OSHA) requires that "All parts of any such industrial truck requiring replacement shall be replaced only by parts equivalent as to safety with those used in the original design."

The installation onto a lift truck of non-certified electronic components may invalidate a truck's UL EE or LPS listing and could pose a safety risk. Customers with UL-listed lift trucks are solely responsible for ensuring compliance with UL for field modifications. The selection of non-OEM parts is made solely by the customer with the awareness that OEM parts are available. Crown Equipment Corporation is unaware of what testing and/or certification, if any, the non-OEM parts have undergone and disclaims all warranties and representations regarding any non-OEM part.



**5W30 Motor Oil****Part Number Sales Unit**

363502-001	Quart
363502-055	55 Gallon/Drum

Superior high quality, multi-viscosity and fuel-efficient motor oil which exceeds manufacturers' warranty requirements. Meets API highest automotive standards for high temperature protection (API SN, SM, SL, SJ).

⚠ **WARNING:** Cancer and reproductive harm - www.P65Warnings.ca.gov

**5W20 Motor Oil****Part Number Sales Unit**

363526-001	Quart
------------	-------

Superior high quality, multi-viscosity and fuel-efficient motor oil which exceeds manufacturers' warranty requirements. Used on Hamech V34 lift trucks with a 2.4 Hyundai LP engine. Excellent low-temperature pumpability for protection during cold starts. Formulated to protect emissions control system catalysts. Keep engine clean by minimizing deposit formation. Improved gas mileage. Reduce oil consumption by reducing volatility and oil evaporation. API SN/RC, SM/SL, API SN, SJ, ILSAC GF-5, Ford (WSS-M2C945A, Chrysler (MS-6395).

⚠ **WARNING:** Cancer and reproductive harm - www.P65Warnings.ca.gov

**10W30 Motor Oil****Part Number Sales Unit**

363500-001	Quart
363500-101	Gallon
363500-055	55 Gallon/Drum

Superior high quality, multi-viscosity and fuel-efficient motor oil which exceeds manufacturers' warranty requirements. Provides the highest API performance level available for gasoline engines. Exceeds U.S. car and truck warranty requirements. Thermal stability to combat sludge build-up. Anti-rust and anti-foam additives.

⚠ **WARNING:** Cancer and reproductive harm - www.P65Warnings.ca.gov

**Food Grade AW32 Hydraulic Oil****Part Number Sales Unit**

363516-005	5 Gallon
363516-055	55 Gallon/Drum

Premium quality, ashless, food-grade lubricant specially developed for the lubrication of machinery in food processing and beverage plants. Registered by NSF

International as an H1 lubricant for use where incidental food contact may occur, also as an H2 lubricant for use in applications where there is no chance for incidental food contact. It also meets former 1998 USDA H1 & H2 guidelines, and is certified Kosher and Pareve. **Meets FDA 21 CFR 178.3570 for incidental food contact.** Used in hydraulic systems, rotary air compressors and circulating systems. Meets performance requirements of Parker Hannifin HPD and Vickers (Eaton). Excellent wear protection for critical system components. Good oxidation resistance to minimize sludge and varnish formation. Protects against rust & corrosion. Good water-separating properties to minimize the formation of emulsions.

**Hydraulic Oil DTE 24****Part Number Sales Unit**

063001-021	1 Gallon
063001-020	55 Gallon/Drum

Mobil DTE 24 Series oils are supreme performance anti-wear hydraulic oils designed to satisfy a wide range of hydraulic equipment requirements.

Note: All products rated by the API will continually be upgraded to meet or exceed the newest standards. All products are blended using some of the highest quality base oils and additives available.

**Universal 10W30 Motor Oil****Part Number Sales Unit**

363510-001	Quart
363510-101	Gallon

Universal 10W-30 Heavy Duty Motor Oil exceeds the demands of API Service Classification CJ-4 / CK-4 / SN, CI-4 Plus. It meets the requirements of Mack EO-O Premium Plus, Volvo VDS-4, Renault VI RDL-3 and Detroit Diesel 93K218 (MBE 4000, MBE 900 Engines). It is a commercial multigrade oil for all-season use by fleets with

diesel power or mix of gasoline and diesel power engines. This oil is designed to perform with currently marketed low and high sulfur diesel fuels. It provides exceptional low temperature flow properties to help cold start, enhanced oxidation stability, excellent TBN retention, superior viscosity retention, deposit control, superior engine protection and durability and outstanding soot handling ability.

⚠ **WARNING:** Cancer and reproductive harm - www.P65Warnings.ca.gov

**15W40 Motor Oil****Part Number Sales Unit**

363523-001	Quart
363523-101	Gallon
363523-055	55 Gallon/Drum

Heavy duty motor oil that is an ideal year-round oil for use in diesel and gasoline powered engines. Provides complete engine protection. Allows easy cold starting and guards against sludge, soot formation, rust and corrosion. Performs with low sulfur diesel fuels. Meets or exceeds the performance requirements for: API Service Classification CJ-4 / CK-4 / SN, CI-4 Plus, Allison C4, Caterpillar ECF-3, Cummins CES 20081, Detroit Diesel 93K218, Mack EO-0 Premium Plus, Mercedes-Benz p228.31, Volvo VDS 4, ACEA E7-04, Renault VI RDL-3 MTU Type I and II engine tests.

⚠ **WARNING:** Cancer and reproductive harm - www.P65Warnings.ca.gov

**Mobil SHC Cibus Food Grade Low Temp Hydraulic Oil AW32****Part Number Sales Unit**

363530-005	5 Gallon
------------	----------

Mobil SHC Cibus Hydraulic Oil is a NSF H1 registered lubricant and it also complies with Title 21 CFR

178.3570 by the Food and Drug Administration (USA) for lubricants with incidental food contact and is accepted by the Canadian Food Inspection Agency for use in food processing facilities. This oil can be used as hydraulic, gear, bearing and circulating oils in all areas within the food processing plant. Pour Point -65° F, Flash Point 487° F.

**AW46 Hydraulic Oil****Part Number Sales Unit**

363527-101	Gallon
363527-005	5 Gallon
363527-055	55 Gallon/Drum

Quality anti-wear AW46 hydraulic oil designed to meet the requirements of fluid power systems. Formulated with a proven anti-wear additive that is effective in reducing pump wear. Excellent water separation, rust and corrosion prevention, oxidation stability and anti-foam properties. Meets or exceeds: Cincinnati Milacron P-68, P-69, P-70, Denison HF-1, HF-2, HF-0, Vickers 35VQ25M-2950-S, I-286-S, GM LH-04-1, LH-06-1, LH-15-1, DIN 51524, Part II, Toshiba Machinery.

**AW68 Hydraulic Oil****Part Number Sales Unit**

363531-101	1 Gallon
363531-005	5 Gallon
363531-055	55 Gallon/Drum

Formulated to provide maximum pump life and trouble free service in industrial and mobile hydraulic systems. Provides long service in high-output hydraulic systems using vane, piston or gear pumps. Meets or exceeds following industry and OEM specifications: Vickers I-286-S, M-2950-S, 35VQ25, Denison TE6-C, HF-1, HF-2, HF-0, General Motors LH-04-1, LH-06-1, LH-15-1, Military Specifications 2075-T-H, 2110-T-H, 2135-T-H.



Hydraulic Oil Additive

Part Number Sales Unit

363537-001 | 1 Quart

Low friction additive for some hydraulic systems, relieves "stick-slip" on noisy hydraulic cylinders. (Not for use on machines which have a common sump for hydraulics, brake, and transmissions.) Compatible with hydraulic oils. Excellent wetting, combats stick-slip. Forms a stable lubricating film which reduces wear. Non-flammable.



STP Oil Treatment Additive

Part Number Sales Unit

363538-001 | 15 oz.

Fights friction to help protect against engine wear by providing a thicker cushion between moving engine parts. Use every oil change or in between. High-viscosity formula. Excellent for all cars, light trucks and SUVs. Resist motor oil breakdown. Counteract oil thinning by boosting viscosity. Increase anti-wear protection. Provides high stress lubrication protection. Add up to 1 bottle for every 4-5 quarts of oil as needed.



Synthetic Compressor Oil

Part Number Sales Unit

363524-001 | Quart

Quality compressor oil has four times the life of mineral-grade compressor oils. Synthetic, all-temperature blend that is designed to increase efficiency, reduce wear and prevent carbon buildup. For use with single and two stage reciprocating air compressors.

⚠️ **WARNING:** Cancer - www.P65Warnings.ca.gov



80W90 Gear Oil

Part Number Sales Unit

363506-001 | Quart
363506-005 | 5 Gallon
363506-055 | 55 Gallon/Drum

High Performance, multi-purpose gear lubricant. Protects in the extreme pressure gear conditions encountered in heavy-duty equipment, trucks, farm tractors, passenger cars, earthmoving, and construction equipment. This oil is recommended where a multi-purpose gear oil or one suitable for API Services, MT-1, GL-5, Mack GO-H, GO-J are required.

⚠️ **WARNING:** Cancer - www.P65Warnings.ca.gov



Gear Oil

Part Number Sales Unit

363536-005 | 5 Gallon

Use in ESR trucks. Demulsifying, fully-synthetic industrial gear oil with elevated aging resistance, excellent load-carrying capacity and wear protection. Great for low and high operating temperatures. Meets or exceeds the following: ISO 6743-6:CKD, AISE 224, FAG-FEG-Test 1-4 pass, DIN 51 517-3:CLP, ISO 12929: CKD, David Brown S1 53.101, SKF: pass (100 degrees C-test).

⚠️ **WARNING:** Cancer and reproductive harm - www.P65Warnings.ca.gov



75W-90 Synthetic Gear Oil

Part Number Sales Unit

363514-001 | Quart
363514-101 | Gallon
063002-044 | 5 Gallon
063002-047 | 55 Gallon/Drum

Mobil Delvac 1 Gear Oli 75W-90 is recommended for TSP 6000 and RC 5500 & SC5200 drive unit, standard or freezer trucks. Used in heavy-duty transmissions, axles and drives requiring API GL-5 and MT-1 performance. Off-highway industries including construction, mining, quarrying and agriculture. Used on-highway light and heavy-duty trucks, busses and vans.



Oil Test Kit

Part Number 363515 — Tests hydraulic and motor oil. Mail oil samples in for content test results. Comes with container for oil, mailing container and labels.

▼ **Test Kit Accessories**

Suction Pump

Part Number - 363515-001 ⚠️

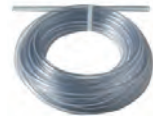

Tubing, 100 Feet

Part Number - 363515-002 ⚠️

⚠️ **WARNING:** Cancer and reproductive harm - www.P65Warnings.ca.gov



Oil-Glo 30

Part Number Sales Unit

363200-001 | Six 1 oz. Bottles
363200-002 | 8 oz. Bottle
363200-003 | 16 oz. Bottle
363200-005 | 1 Gallon Pail
363200-007 | 5 Gallon

363200-001

Oil Glo 30 is a fluorescent dye used to aid in leak detection. It works with any host fluid and will not damage fluid. When added to a fluid system and circulated, the dye can help identify the source of a leak by glowing brightly when scanned with an UV inspection light. Oil Glo 30 glows white under ultraviolet light. Recommended usage ration is: 1 oz. dye to 8 gal. of fluid.



363200-003

Part Number Description

363200-016 | UV LED Flashlight
363200-011 | UV Flashlight Kit
363200-008 | Safety Glasses - Amber Lens with Amber Temples
363200-010 | Safety Glasses - Amber Lens with Black Temples



363200-016



363200-010



Hydraulic Fluid Anti-Wear AW32

Part Number Sales Unit

363504-101	Gallon
363504-005	5 Gallon Pail
363504-055	55 Gallon/Drum

Excellent benefits are achieved when using our high quality Anti-Wear Hydraulic Fluid. Reduced filter blockage and sludge formation. Extended fluid and pump life. Improved durability of non-ferrous parts. Compatible with existing fluids.

Reduces downtime and maintenance cost. Meets the most severe requirements of hydraulic pump and equipment manufacturers including the following specifications: Denison HF-1, HF-2, HF-0, HG-14, TE6-C. Vickers I-286-S, M-2950-S. DIN 51524 Part 2. U.S. Steel 136, 127. Racine, variable volume pump. Vickers 35VQ25. Cincinnati Milacron P-68, P-69, P-70. General Motors LH-04-01, LH-06-01, LH 15-1. B.F. Goodrich O152. Lee-Norse 100-1. Military Specifications 2075-T-H, 2110-T-H. Toshiba Machinery. Afnor 2-48-603.



Mobil HD Transmission Fluid

Part Number Sales Unit

363522-001	Gallon
363522-005	5 Gallon Pail
363522-055	55 Gallon Drum

Mobiltrans HD 10W is an extra high performance, heavy duty transmission and drive-train lubricant engineered to meet or exceed the requirements of the rigorous Caterpillar TO-4 specification. This product line is uniquely designed to optimize the performance of powershift transmissions, gearboxes, and final drives. In hydraulic applications, they provide maximum protection even in high pressure systems.



Hydraulic Fluid Low Temp

Part Number Sales Unit

363505-101	1 Gallon
363505-005	5 Gallon Pail
363505-055	55 Gallon/Drum

Low temp hydraulic fluid meets the most severe requirements of hydraulic pump and equipment manufacturers. This high quality formulation has a long history of excellent performance and provides long, trouble-free service over a wide range of operating conditions. Operates in a wide range of temperatures and is designed for freezer applications. Meets military specs MIL PRF-5606 and NATO Code H-515.



Mobil 424 Hydraulic Fluid

Part Number Sales Unit

363532-002	2.5 Gallon
363532-005	5 Gallon Pail

Extra high performance multipurpose tractor lubricant engineered to meet or exceed transmission and hydraulic fluid requirements. It is particularly well suited for reducing wet brake and Power Take-Off (PTO) chatter. SAE 80W. Meets Allison C4, API GL4, Vickers 35VQ25, Caterpillar TO-2, John Deer J20C. For Hamech / CLARK with Wet Disc Brakes.



Automatic Transmission Fluid

Part Number Sales Unit

363503-001	Quart
363503-101	1 Gallon
363503-055	55 Gallon/Drum

Premium transmission fluid provides transmission protection, smooth shifting and long service life. Meets the requirements of most US and import specifications. Recommended for service in cars & light truck automatic transmissions where Dexron® III or Mercon® fluid is specified. Meets Allison C-4, ZF TEML 14 Heavy Duty.

⚠ **WARNING:** Cancer and reproductive harm - www.P65Warnings.ca.gov



Dot 3 Brake Fluid

Part Number Sales Unit

363507-001	Net wt 12 oz
------------	--------------

National Brake Fluid meets SAE J1703 and FMVSS-116 specs.



Dot 5 Brake Fluid

Part Number Sales Unit

063004-002	Net wt 12 oz
063004-003	Gallon

Premium brake fluid that meets all required specs for use in Crown lift trucks.



Universal Hydraulic and Transmission Fluid

Part Number Sales Unit

363513-001	Quart
063001-025	55 Gallon/Drum

All season hydraulic and transmission fluid designed to meet the special lube requirements of most industrial trucks and implements. This fluid provides EP protection, oxidation and corrosion resistance, and moisture dispersion capability. Meets or exceeds the following fluid requirements. AGCO-ALLIS, ALLIS CHALMERS, DEUTZ-ALLIS Power Fluid 821 XL, 272843, 257541, 246634/ Allison C-3, C-4. International B-6 (Hy-Tran), B-5, Steiger SEMS 17001/ Caterpillar TO-2/ Denison HF-0, HF-1, HF-2/ John Deere J20D (Hy-Gard), J20C (Hy-Gard), J20A/B, J14B (303 Fluid)/ Kubota UDT Fluid.



ISO VG 10 Brake Fluid

Part Number Sales Unit

363543-101	Gallon
363543-005	5 Gallon
363543-055	55 Gallon/Drum

Mobil Velocite Oil No. 6 is a premium performance product for use in high-speed systems. Formulated with high quality, low viscosity base oils and additives to provide good resistance to oxidation, protection from rust and corrosion, resistance to foaming, and effective water separation. ISO VG 10.



BlueDEF® Diesel Exhaust Fluid

Part Number	Sales Unit
363525-002	2.5 Gallon
363525-055	55 Gallon Drum

Mixture of high purity synthetic urea and deionized water. Contains no chemical additives or other compounds that could cause SCR system failure. Meets the quality standards established by the ISO-22241-1 for Diesel Exhaust Fluid. Certified by the American Petroleum Institute. For Diesel SCR engines.



Antifreeze - Concentrated

Part Number	Sales Unit
363509-101	Gallon

Antifreeze - 50/50

Part Number	Sales Unit
363509-101-50	Gallon

Universal formula for both automotive and heavy-duty diesel engines (ASTM D3306 and ASTM D4985). Green. Freezing Point - 34°F, Boiling Point 224° F.



Dex-Cool Antifreeze/Coolant - Concentrated

Part Number	Sales Unit
363511-101	Gallon

DEX-COOL approved. Protection up to five years/150,000 miles. Patented formula contains no silicates, phosphates, borates, nitrates or amines. Excellent rust and corrosion protection.

Helps prevent boil-overs and freeze-ups. Protects all cooling system metal including aluminum. Organic Acid Technology (OAT) minimizes corrosion inhibitor depletion. Heavy duty extended life coolant specifically for diesel and heavy duty trucks. Not for use in RST, C-5, C-G & C-D trucks.



Acustrip - Antifreeze Test Kit

Part Number	Sales Unit
380030-189	70 Test Strips

Make sure antifreeze in gas trucks does not reach an acidity level that ruins seals, gaskets and parts. Provides an exceptional, simple and economical way to test all types and colors of coolants for their freeze point, boil over, and corrosion protection. Perform the test in a minute without the need for separate instruments or laboratory analysis. Regular testing of antifreeze coolant minimizes downtime and its associated costs. Test before maintenance is performed. Meets or exceeds standards as outlined with: EVA Certification, GMP, AMRA/MAP UICS.



De-Icer Concentrate

Part Number	Sales Unit
363529-055	55 Gallon Drum

Specially formulated to remove oil, road grime, and bugs from the windshield. The level of freezing protection is -20°F (-29°C).



Mobil Delvac Extended Life Coolant 50/50 Premix

Part Number	Sales Unit
363535-101	Gallon
363535-005	6 (1) Gallon Bottles
363535-055	55 Gallon Drum

Ready to use phosphate-free, silicate-free, nitrite-free and borate-free ethylene glycol base coolant that is designed to provide exceptional wet sleeve liner cavitation and corrosion protection of all cooling system metals. It is formulated with organic corrosion inhibitors to provide total cooling system protection. Since the organic corrosion inhibitors do not readily deplete, it eliminates the need for supplemental coolant additives (SCAs) as required when using conventional coolants. Red in color. Use in RST, C-5, C-G & C-D trucks.

⚠ WARNING: Reproductive Harm - www.P65Warnings.ca.gov



Windshield Washer Fluid

Part Number	Sales Unit
300100-101	1 Gallon
300100-055	55 Gallon Drum

Windshield Washer Fluid is a conventional blue all-season windshield cleaner that is safe to use in any vehicle. Formula strengths -20°F.

Note: Windshield wiper blades available. See p. 1.14.



Multi-Purpose Grease

Part Number	Sales Unit
063002-034	14 oz tube
063002-045	Case (40) - 14 oz tubes
063002-032	35 lbs (5 gallons)
363003	121 lb keg
363003-055	396.8 lb drum

Multi-purpose, high performance, high temperature, lithium grease that provides exceptional resistance to water wash out and prevents wear. Recommended for heavy duty service in all lubricating points. NLGI 2. Used in the following applications: wheel axles, fork slides, steering gears, reach assemblies. Temperature maximum: 284°F.



JT6 High Temp Grease

Part Number	Sales Unit
363004-001	Net wt 14 oz Tube

High temperature lithium grease. Provides excellent protection to disc brake wheel bearings, hinge pins and conveyor bearings. Approved for use in Rockwell and Spicer universal joints. Red in color. NLGI certified. Temperature range -10°F to 325°F.



JT6 Low Temp Grease

Part Number	Sales Unit
363006-001	Net wt 14 oz Tube

JT6 Lo-Temp Extreme Grease is a superior multi-purpose, EP lubricant with outstanding low temperature properties. Excellent water resistant, anti-wear, and rust corrosion protection. Recommended for extremely low to medium temperatures where friction and good flow at low temperatures are required. Temperature range: -65°F to 250°F.



JT6 Multi-Purpose Grease

Part Number	Sales Unit
363005-001	14 oz Tube

Multi-purpose grease is extremely water resistant and water insoluble. Light-colored, low staining, and has a very low oil separation rate. Provides excellent anti-seize protection under high loads. Stays in place better than most other greases. It is fully rust and oxidation inhibited. A medium temperature range multi-purpose grease for extreme pressure loads, slow to medium speed bearings, greased chassis points, fifth wheels, and water pumps. Temperature range: 0°F to 250°F.

▲ **WARNING:** Cancer - www.P65Warnings.ca.gov



Low Temperature Multi-Purpose Grease

Part Number	Sales Unit
063002-017	Net wt 14 oz Tube
063002-046	Case (40) - 14 oz Tubes
063002-005	5 Gallon Pail

High performance grease for low temperature applications. Provides a high resistance to water wash and prevents wear in the coldest environments. Temperature range: -60°F to 250°F.



Premium Multi-Purpose Lubricating Grease

Part Number	Sales Unit
063002-025	Net wt 14.5 oz Tube
063002-026	35 lbs (5 gallons)

Mobilux EP 2 is a high performance, general-purpose industrial-type grease. This lithium hydroxystearate based grease is formulated to provide extra protection against wear, rusting and water washout. The recommended operating temperature range is from -20°C to 130°C, but it may be used at higher temperatures if the lubrication frequency is increased.



DAYLube™ Food Grade NanoCeramic Lubricating Grease

Part Number	Sales Unit
363008-001	16 oz Tube

High-performance lubricating grease, NLGI No. 2, used where incidental contact with food is a possibility (NSF-H1). Excels in applications where resistance to water washout and broad operating temperatures are absolutely necessary. Operating range of -40°F to + 800°F. The formulation of this product provides unsurpassed resistance to extreme pressures and corrosion, including salt spray. It contains no heavy metals or other environmentally undesirable additives.

▲ **WARNING:** Cancer - www.P65Warnings.ca.gov



Food Grade Multi-Purpose Grease

Part Number	Sales Unit
363002-002	10 oz Spray
363002-001	14 oz Tube
363002-005	37.5 lbs (5 gallons)

Advanced food grade grease specially formulated for the toughest food processing applications. Provides outstanding protection against wear and water washout, over a wide range of operating temperatures. **Meets the highest food industry safety standards.** Temperature range: -40°F to 392°F.



Electric Motor Grease

Part Number	Sales Unit
363010-001	14.1 oz Tube

Mobil Polyrex EM grease is specially formulated for electric-motor bearings. Provides outstanding long-life, high-temperature lubrication of ball and roller bearings, excellent corrosion resistance, and advanced polyurea thickener protection for long electric motor life.



Molykote BR2-Plus Multi-Purpose Extreme Pressure Grease

Part Number Sales Unit

063002-024	Net wt 14.1 oz Tube
063002-022	35 lb Pail

Extreme pressure bearing grease. Used for ball bearings, roller bearings, sleeve bearings, swivel joints, metal-to-metal, spindles, splines & shafts. Recommended using in mast channels.

⚠ **WARNING:** Cancer - www.P65Warnings.ca.gov



Molykote 44M Grease

Part Number Sales Unit

063002-043	Net wt 5.3 oz Tube
------------	--------------------

High temperature bearing grease with medium consistency. Contains silicone, resistant to oxidation, moisture and corrosive atmospheres, -40° F to 400° F.

⚠ **WARNING:** Cancer - www.P65Warnings.ca.gov



Grease Gun, Lever Handle 10,000 PSI

Part Number - 323000

Rugged pump with cast iron head for strength and durability. Heavy-duty plated steel lever handle. "Flip-Over" follower allows for a superior seal. For use with 16 ounce bulk or 14.5 ounce cartridge.

Accessories:

18" Whip Hose Extension - P.N. 323000-100

Hydraulic Coupler - P.N. 323000-101

Note: Both parts can be added to 323000 to make a flex hose.



323000-100



323000-101



Grease Gun, Lever Handle 10,000 PSI

Part Number - 323000-001

Flex hose nozzle extension. Rugged pump with cast iron head for strength and durability. Heavy duty plated steel lever handle. Barrel with flip follower allows for a superior seal. For use with 16 ounce bulk or 14.5 ounce cartridge.



Grease Gun, Pistol Grip Handle 3,500 PSI

Part Number - 323001

Flex-hose nozzle extension. Includes die-cast aluminum pump head, hose and follower.



120 lb. Grease Pump

Part Number - 363160

Use with 120 lb keg. Pump ratio: 60:1. Includes: pump, drum cover, follower plate, 1/4" x 6' high pressure hose, 3/8" x 6' air hose, filter regulator w/ gauge.



35 lb. Grease Pump

Part Number - 363167

Designed for 35 lb. grease containers. Includes: 50:1 high pressure pump, control handle, Z-swivel, drum cover, follower plate and 8' outlet hose.



Mast Lubrication Tool Kit

Part Number - 363163

Use for greasing hard-to-reach areas on mast channels. The 6-12 ft pro-pole provides an extension for the chip brush to grease desired areas. Kit includes: Pro-Pole, Brush Holder, and 3" Straight Edge Chip Brush.

Replacement Brush: P.N. 363163-003



Mobile Grease XHP005

Part Number Sales Unit

063002-060	16 oz can
------------	-----------

High-temperature grease for centralized grease application systems, gear lubrication, and where extreme-cold-temperature pumpability is important. NLGI grade 00. Used on steering gearbox on TSP6000/6500/7000.



Spline Grease

Part Number Sales Unit

063002-039	1 lb Jar
127801S	1 oz Jar

Synthetic spline grease with PTFE & MoS2. Used specifically for Crown lift pump motor spline connection.

⚠ **WARNING:** Reproductive - www.P65Warnings.ca.gov

Cleaners - Kit and Accessories

Aerosol Products Kit*

Part Number - 363121

Kit includes heavy-duty storage bucket with lid seat kit contents listed right. SDS sheets included in kit.

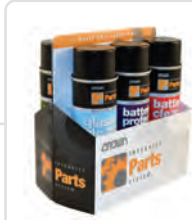

Note: PF14423 6-Pack Carrier. Holds up to 6 aerosols or soaps. Aerosols not included.

▼ Contents

Part Number (Can)	Product	Quantity
363120	5 Gallon Storage Bucket with Lid Seat	1
363119-001	Low V.O.C. Brake and Parts Cleaner	1
363115-001	Premium Chain & Cable Lube	1
363106-001	Electrical Grade High Purity Contact Cleaner	1
363104-001	Penetrating Lubricant	1
363108-001	Premium Formula Multi-Purpose Grease	1
363110-001	White Lithium Grease	1
363109-001	Choke & Carburetor Cleaner	1
363105-001	Degreaser & Cleaner	1
363114-001	All Purpose Cleaner	1
363101-001	Glass Cleaner	1
363111-001	Waterless Hand Cleaner	1

▲ **WARNING:** Cancer and reproductive harm - www.P65Warnings.ca.gov



5 Gallon Storage Bucket with Lid Seat

Part Number - 363120

Cleaners - Hand Cleaners and Accessories



Waterless Hand Cleaner

Part Number	Sales Unit
363111-001	Net wt 15 oz Tube
363117-001	Gallon Jug

Excellent for service technicians on the road, this waterless hand cleaner removes oil, grease, paint, and soil without the need to rinse with water. Keeps your hands from feeling raw or dry from over scrubbing.



Pumiced and Smooth Hand Cleaner

Part Number	Sales Unit
363166-001	Net wt 16 oz Bottle
363168-001	Gallon Jug

Pumice fortified hand cleaner that removes encrusted grime, soil, heavy grease, and embedded paints and stains. This one gallon jug can be dispensed with a hand pump or wall mounted shop dispenser.



Soap Hand Pump - Gallon Jug

Part Number - 363123

Durable hand pump designed to remove the maximum amount of soap from each container, with its extra long tube.



Wall Mounted Deluxe Soap Dispenser

Part Number - 363122

Heavy-duty stainless steel construction, with a pump that will not drip.



Hand Sanitizer*

Part Number	Sales Unit
365296-012	12 bottles/case

Gel based hand sanitizer made with 70% USP cosmetic grade Ethyl Alcohol. Kills 99.99% of germs. Scent free, gentle formula keeps skin smooth. Does not irritate or dry the skin. Push cap for easy dispensing from 16.5 fluid ounce bottles.



Hand Cleaner Gel

Part Number	Sales Unit
363540-101	1 Gallon
363541	Hand Pump for 5 Gallon

Contains 80% alcohol which meets the CDC recommendations for a hand sanitizer. Formula includes glycerin to moisturize hands. Dispense on hands to help reduce bacteria. Rub hands together until dry.

*Available only to customers in USA

Cleaners - Surface Cleaners



Citra-Sol Degreaser

Part Number Sales Unit

363146-001 | Net wt 19 oz Can

Formulated with orange citrus solvents, this product removes grease, especially animal fats, oil, dirt, and scuff marks from floors. Can be used on porcelain and tile surfaces. Effective on sticky or tar based surfaces. Leaves no residue, and is safe on painted surfaces.



Degreaser and Cleaner

Part Number Sales Unit

363105-001 | Net wt 19 oz Can

363105-C01 | Net wt 19 oz Can - Canada

363105-M01 | Net wt 19 oz Can - Mexico

Heavy-duty formula uses a high foaming spray for cleaning and clinging to vertical and horizontal surfaces. With a blend of ammonia and butyl, this fast-acting cleaner attacks and loosens dirt, greases, oils and much more from hard surfaces. May remove certain paints - test in small area.



Glass Cleaner

Part Number Sales Unit

363101-001 | Net wt 19 oz Can

Easy to use, fast-acting product that uses a clinging foam to break-up soils and hold them even on vertical surfaces. With an exclusive formulation using denatured alcohol and no ammonia, this product cleans thoroughly, dries quickly, requires no rinsing and leaves no streaks.

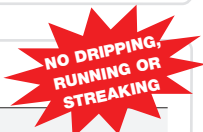

Ethanol Surface Cleaner

Part Number Sales Unit

363542 | 5 Gallon Pail

Multi-purpose, 79% ethyl alcohol hard surface cleaner. Fill spray bottles and spray surface. Surface must remain wet for 60 seconds. Wipe or air dry. No rinsing required.

⚠ **WARNING:** Cancer and reproductive harm - www.P65Warnings.ca.gov



All Purpose Cleaner

Part Number Sales Unit

363114-001 | Net wt 19 oz Can

Safe to use on almost any surface, this foaming cleaner contains a unique blend of detergent systems that cut through dirt, grime, and grease. Dries streak-free leaving surfaces crystal clear.

Cleaners - Specialty Cleaners

Continued ▶



Low V.O.C. Brake and Parts Cleaner

Part Number Sales Unit

363119-001 | Net wt 15 oz Can

363119-M01 | Net wt 15 oz Can - Mexico

High performance non-chlorinated brake cleaner with no carbon tetrachloride or silicones. Accomplishes 3 times the work of an economy low V.O.C. brake cleaner. No more one can per brake job usage. Designed with a powerful blasting spray for fast acting, quick drying, and residue free results. Extension tube included.

⚠ **WARNING:** Cancer and reproductive harm - www.P65Warnings.ca.gov



High V.O.C. Brake & Parts Cleaner

Part Number Sales Unit

363147-001 | Net wt 14 oz Can

Helps improve brake performance by instantly removing grease, oil, brake fluid, dirt and other residues from brake linings and drums. Application can be made without disassembling brake unit. Reduces disc brake squeal, and leaves no surface film. **Not for use in the following states:** California, Colorado, Connecticut, Delaware, District of Columbia, Illinois, Indiana, Maine, Maryland, Massachusetts, Michigan, New Hampshire, New Jersey, New York, Ohio, Pennsylvania, Rhode Island, Utah, Vermont, or Virginia; also Canada.



45% V.O.C. Brake & Parts Cleaner

Part Number Sales Unit

363154-001 | Net wt 14 oz Can

High performance non-chlorinated brake cleaner. Designed with a powerful blasting spray for fast acting, quick drying, and residue free results. More powerful than our Low V.O.C. Quickly removes brake fluid, grease, oil and other contaminants from brake linings & pads. Extension tube included. **Not for use in the following states:** California, Colorado, Connecticut, Delaware, Maryland, Michigan, New Hampshire, New York, Ohio, Rhode Island or Utah.



Non-Flammable Brake Cleaner

Part Number Sales Unit

363116-001 | Net wt 18.05 oz Can

363116-C01 | Net wt 18.05 oz Can - Canada

363116-M01 | Net wt 18.05 oz Can - Mexico

High performance non-flammable brake cleaner. Designed with a powerful blasting spray for fast acting, quick drying, and residue-free results.

Extension tube included. **Not for use in the following states:** California or New Jersey.



Choke and Carburetor Cleaner

Part Number	Sales Unit
363109-001	Net wt 14 oz Can

Instantly cleans carburetor throat, the automatic choke butterfly valve, the PCV valve and the linkage. This excellent cleaner is computer/oxygen sensor safe, leaves no sticky film, removes gum and varnish and helps increase gas mileage. Extension tube included.

⚠ **WARNING:** Reproductive Harm - www.P65Warnings.ca.gov



Final Step

Part Number	Sales Unit
363129-001	Net wt 11 oz Can
363129-C01	Net wt 11 oz Can - Canada
363129-M01	Net wt 11 oz Can - Mexico

Great silicone release agent. Works on plastic, rubber, vinyl and metal. **Will not collect dirt.** No need to wipe off; spray on and leave it.

⚠ **WARNING:** Cancer and reproductive harm - www.P65Warnings.ca.gov



Sea Foam Engine Cleaner & Lube

Part Number	Sales Unit
363161	Net wt 12 oz Can

For internal combustion engine use to clean carbon deposits from intake systems, intake valves and combustion chambers.



Battery Cleaner

Part Number	Sales Unit
363124-001	Net wt 18 oz Can
363124-C01	Net wt 18 oz Can - Canada
363124-M01	Net wt 18 oz Can - Mexico

Heavy duty industrial battery cleaner is engineered for fast, effective, economical maintenance of storage battery terminals, hold downs, cables and battery boxes. It detects leaks by changing from yellow to reddish purple when it comes in contact with acid. It neutralizes the acid.

⚠ **WARNING:** Cancer - www.P65Warnings.ca.gov



Battery Protector

Part Number	Sales Unit
363125-001	Net wt 14 oz Can
363125-M01	Net wt 14 oz Can - Mexico

Heavy-duty industrial, non-methylene chloride, battery protector extends battery life and prevents corrosion. It provides an air-tight, waterproof seal, and resists oil, gasoline, dirt, grease and heat. Assures maximum electrical connectivity.



Black Battery Reconditioner

Part Number	Sales Unit
363133-001	Net wt 12 oz Can

Restores battery to original look. Formulated to adhere to battery plastics and metal. Ideal for automotive, truck and industrial batteries. When dry, paint finish resembles gloss of original molded plastic. Industrial grade, high solids for single coat coverage, outstanding hardness and durability, resists abrasion and heat. Fast drying. Other uses include battery hold-downs, trays and cases.



Contact Cleaner

Part Number	Sales Unit
363128-001	Net wt 13.5 oz Can
363128-M01	Net wt 13.5 oz Can - Mexico

Excellent precision cleaning solvent that cleans and protects sensitive electronic components and contacts. Instantly penetrates hard-to-reach areas to safely dissolve dirt, dust, grease, flux and other contaminants on contact. Dries fast with zero residue. Regular use helps prevent contact failure and malfunction. Harmless to most plastics and paper tapes. 22,600 volts/mil dielectric strength. EPA snap approved.

⚠ **WARNING:** Cancer and reproductive harm - www.P65Warnings.ca.gov



Non-Flammable Electrical Grade High Purity Contact Cleaner

Part Number	Sales Unit
363106-001	Net wt 10 oz Can
363106-M01	Net wt 10 oz Can - Mexico

Electrical grade high purity contact cleaner is safe to use on almost any electrical product: Circuit Boards, Wire Terminals, Relays, Switches, Contacts, Circuit Breakers, Tuners, Potentiometers, Control Panels, Motors, and other electrical equipment. There are cheaper contact cleaners on the market, but they run a much greater risk of damaging the plastics, paints, and rubbers that surround most electrical components. This product can be used with the confidence that it will not damage the components you are trying to clean. **Not for use in the following state: Maine.**



DeoxIT Contact Cleaner

Part Number	Sales Unit
363136	Net wt 5 oz Can

DeoxIT Contact Cleaner/Rejuvenator is a fast-acting deoxidizing solution that cleans, lubricates, protects and improves conductivity on metal connectors, contacts and surfaces. It is ideal for stationary and moving contacts and connectors. Stabilizes connections between similar and dissimilar metals.



DeoxIT Gold

Part Number	Sales Unit
363155	Net wt 5 oz Can

DeoxIT Gold is a unique contact cleaner, conditioner, enhancer, lubricant and protectant for PLATED metal surfaces. Improves conductivity, maintains optimum signal quality, reduces fretting & dendrite corrosion, and stabilizes connections between similar and dissimilar metals. It also reduces wear and abrasion, arcing, RFI and intermittent connections and improves connector performance/reliability. Ideal for gold plated surfaces. On oxidized surfaces, pre-treat with DeoxIT contact cleaner.

Cleaners - Specialty Cleaners

Performance® Disinfectant Wipes*



Part Number	Sales Unit
365298-004	800 sheets/roll; 4 rolls/case

Antibacterial disinfecting wipes kills 99.9% of bacteria in 15 seconds. Great for disinfecting hard surfaces. Performance wipes are an excellent and cost effective way to disinfect your service vehicles, work areas, equipment, lunchrooms and restrooms. Bleach, Benzyl Alcohol, Citrus and Phenol free. EPA registered in all 50 states. Various dispensing options below.



Bucket Dispenser*



Part Number	Sales Unit
365298-BKT	1 Bucket

For use with Performance® Disinfectant Wipes. 10.75" diameter. Holds 2.9 gallons.

Bucket Dispenser Lid*



Part Number	Sales Unit
365298-LID	1 Lid

For use with Performance® Disinfectant Wipes. Snap on lid with flip top cap. Lid and pail sold separately.

Centerfeed Wall Mount Dispenser*



Part Number	Sales Unit
365298-WMT	Smoke gray dispenser

Wetworks® Pre-Moistened Centerfeed Towel Dispenser. For use with Performance® Disinfectant Wipes. 9.5"x9.5"x13".

Floor Dispenser with Hidden Waste Basket*



Part Number	Sales Unit
365298-FLR	Stainless Steel Waste Basket

Includes bucket and lid dispenser. For use with Performance® Disinfectant Wipes. Heavy gauge stainless steel; dispenses one wipe at a time from the top. Sleek design with hidden wastebasket.



363130-001

Multi-Surface Cleaner Wipes

Part Number	Sales Unit
363130-001	70 Wipes per Tub
363130-101	70-Wipe Refill Pack

Heavy-duty waterless cleaner wipes cut through tar, grease, wax, ink, paint, lubricants and adhesives. These non-scratching, citrus-scented towels are industrial strength. They don't leave an annoying residue.



363130-101 (Refill Pack)

*Available only to customers in USA

Aerosol Lubricants



Chain and Cable Lube

Part Number Sales Unit

363107-001 | Net wt 15 oz Can

Premium-quality chain lube fortified with molybdenum disulfide and graphite, reducing friction and wear for longer chain life. This lubricating film will not wipe away under extreme pressure and high speeds. Especially recommended for exposed chains where contamination is a problem. Extension tube included.

⚠ **WARNING:** Cancer - www.P65Warnings.ca.gov



Premium Chain and Cable Lube

Part Number Sales Unit

363115-001 | Net wt 12 oz Can

363115-C01 | Net wt 12 oz Can - Canada

363115-M01 | Net wt 12 oz Can - Mexico

Superior, non-gumming premium oil that penetrates and lubricates all types of chains and cables. Prevents wear and rust. Loosens rusty nuts. Goes on clean, not running or dripping. Extension tube included.



Dock Door Lube

Part Number Sales Unit

363145-001 | Net wt 16 oz Can

Superior lubricant that prevents friction and wear. This long-lasting, odorless, non-drip spray is safe on most plastics. Use on garage or overhead doors, hinges and pins, cables, springs, door tracks and chains, bearings and bushings, dock parts, hold-downs, rollers and toe guards. It's great in a variety of applications where a high quality lubricant is needed.

Not for use in the following state: California.



Penetrating Lubricant

Part Number Sales Unit

363104-001 | Net wt 15 oz Can

363104-M01 | Net wt 15 oz Can - Mexico

Heavy-duty penetrant that cleans, loosens and protects faster than traditional products. The high concentration of AOLX in this product displaces water and reaches deep down to loosen nuts and bolts where corrosion and rust have collected. Inhibits rust and stops corrosion on battery terminals. Extension tube included.



Channel Slide Lube

Part Number Sales Unit

363143-001 | Net wt 10.5 oz Can

High performance petroleum based lubricant, fortified with finely diffused moly sulfide to protect against wear and corrosion. Designed for use in industrial, heavy equipment, shop applications, automotive, marine, and farm. Use on inner slides and mast slides, torsion bars, fifth wheels, rails and rollers.

⚠ **WARNING:** Reproductive Harm - www.P65Warnings.ca.gov



Premium Formula Multi-Purpose Grease

Part Number Sales Unit

363108-001 | Net wt 13 oz Can

363108-C01 | Net wt 13 oz Can - Canada

363108-M01 | Net wt 13 oz Can - Mexico

Premium Formula Multi-Purpose Grease is a unique formulation of superior quality industrial lubricants in a convenient aerosol form. This product offers tremendous coating ability that withstands seizing, pounding out, wash-out and excessive wear. Timken rated (load bearing) to 65 lb and heat stable to 500 plus degrees.

Not for use in the following state: California.

⚠ **WARNING:** Cancer and reproductive harm - www.P65Warnings.ca.gov



White Lithium Grease

Part Number Sales Unit

363110-001 | Net wt 14 oz Can

363110-C01 | Net wt 14 oz Can - Canada

363110-M01 | Net wt 14 oz Can - Mexico

Highly concentrated, heavy-duty spray grease lubricant that leaves a long-lasting film and has excellent resistance to heat. Great for anything that squeaks, sticks or rusts. Extension tube included.

⚠ **WARNING:** Cancer and reproductive harm - www.P65Warnings.ca.gov



Moly PTFE 45 Plus Lubricant

Part Number Sales Unit

363153-001 | Net wt 15 oz Can

This lubricant is formulated with PTFE and fortified with Moly to provide long lasting lubrication and protection from friction, wear and corrosion. The light viscosity of this product allows for deep penetration into hard to reach parts. Safe for use on most surfaces.



Food Grade Machinery Lubricant

Part Number Sales Unit

363127-001 | Net wt 12 oz Can

Non-toxic, anti-wear fortified oil for use on bottling, dairy and food processing machinery. For chain, cables, conveyors, slides, o-rings, valves, pistons, seals and general lubrication. Certified OU Kosher Pareve. Manufactured with ingredients that comply with FDA regulation 21 CFR 178.3570 and 178.3530 for lubricants with incidental food contact.



Food Grade Silicone Spray

Part Number Sales Unit

363126-001 | Net wt 11 oz Can

Can be used on food packaging and processing equipment as a protective anti-rust film, as a release agent on gaskets or seals of tank closures and as a lubricant for machine parts and equipment. This product can be used in contact with fresh, frozen, cooked or baked food products when used in accordance to prescribed regulations. **Manufactured with ingredients that comply with FDA regulation 21 CFR 178.3570 for lubricants with incidental food contact.**



Citrus Degreaser Spray

Part Number	Sales Unit
363156-001*	Net wt 32 oz Bottle
363156-001-L	Label for 32 oz Bottle
363139	32 oz Bottle Hand Pump
363157-101	1 Gallon Refill
363158-101	1 Gallon (Concentrated)

Instantly cleans grease, oils, and fats without the use of harsh acids, alkalines or petroleum solvents. For use on all washable surfaces. 100% biodegradable. Environmentally friendly with reusable containers and no ozone hazardous chemicals. More economical than aerosol cleaners especially when using the refills. Available in quart spray bottles and 1 gallon refills.

*Note: Includes Pump Spray Nozzle

55 Gallon Poly Drum (Empty)

Part Number - 363141

Mix Ratio: 3 Gallons Citrus Degreaser Concentrate (P.N. 363158-101) per 52 Gallons Water

Contents Label included.

Replacement Label: P.N. 363141-L



55 Gallon Drum Plastic Pump

Part Number - 363142



Non-Flammable Brake Cleaner Bulk

Part Number Sales Unit

363150-005	5 Gallon
363150-055	55 Gallon Drum

Formulated to effectively and quickly flush dust, grease, dirt, and oil from brake shoes, retaining springs, and backing plates. **NOTE: Not for use in California and New Jersey.**

⚠ **WARNING:** Reproductive Harm - www.P65Warnings.ca.gov



Stainless Steel & Plastic Pumps

Part Number	Sales Unit
363151-001	55 Gallon Stainless Steel Drum Pump
363151-002	5 Gallon Stainless Steel Bucket Pump
363142	55 Gallon Drum Plastic Pump (see photo above)



Floor and Vehicle Wash - Concentrated

Part Number	Sales Unit
363132	6 Gallon
363132-055	55 Gallon

Premium liquid floor cleaner and vehicle wash. It is formulated to remove grease and oils, dirt, road film and bug residue in one application without brushing. Safe on all paint at the suggested dilution, is free rinsing and leaves a shine. This wash is made from 100% biodegradable detergents and contains no caustics, phosphates, acids or solvents. Was designed for use with sweeper/scrubber floor cleaning units as well as pressure washing applications. This very concentrated product can be diluted 40:1 for light cleaning and 10:1 for heavy cleaning on vehicles. Works well in sweeper/scrubber floor cleaning units at 25:1 dilution. Use with a bucket and brush at 20:1 dilution ratio.



Industrial Battery Cleaner/Neutralizing Wash Cleaner

Part Number	Sales Unit
300422-001	Quart
300422	5 Gallon
300422-035	35 Gallon



- Dissolves corrosion, eliminates acid shorts
- Stops damaging corrosion
- Allows for reuse of wash water
- Safe to use on all industrial and starter batteries
- Neutralizing Wash Cleaner with color change, turns purple when acid is present and back to yellow when safe

Wash Cleaner color indicates when acid is neutralized.

Acid Present Neutralizing Safe

Note: Protective acid resistant goggles and gloves are recommended.

Wash Water Neutralizer

Part Number	Sales Unit
300415-005	5 Gallon

Used to adjust pH in wash water and clean acid contaminated floors and equipment such as battery racks and delivery vehicles.

- Concentrated sulfuric acid neutralizer
- Non-corrosive and non-hazardous
- Allows for reuse of wash water
- Can also be used to remove acid from concrete floors
- Use on Reusable Battery Acid Floor and Counter Mat P.N. 300403-050 (see Section 8, Battery and Charger)



Acid Spill Absorber and Neutralizer

Part Number	Sales Unit
300421	5 Gallon
300421-030	30 Gallon

- Specifically formulated to absorb and neutralize battery acid, with color change to show when acid is neutralized and safe for disposal
- Ideal for use in acid drip pans
- Safe and non-hazardous
- Sweeps up clean and dry, is not dusty like kitty litter/clay
- Durable easy to store container with resealable lid
- Instructions and SDS included See OSHA 1926.441 & 1910.173



Non-Butyl Cleaner/Degreaser

Part Number	Sales Unit
063009-005	1 Gallon

General purpose cleaner for food processing plants, kitchens, factories, schools and office buildings. Its degreasing and deodorizing properties make it suitable for mopping, spraying or wiping. Use it to clean walls, floors, fixtures, equipment and utensils. Its low-sudsing formula contains rust inhibitors, rinses quickly and is fortified with builders for fast soil penetration and emulsification.



Bulk Service Supplies

SPRAY TOOLS

Sure Shot sprayers are an inexpensive way to apply bulk chemicals like cleaners, degreasers, penetrating oils, solvents and lubricants. They use readily available compressed air, instead of propellants, and because they are reusable you don't have to worry about disposal of empty cans. Not recommended for acids or paint.



Sure Shot Sprayer - 32 oz.

- Part Number - 363148**
- Enameled steel
 - Brass nozzles
 - Can be used with oil and solvent-based materials
 - Do not use water or water-based materials in steel sprayers
 - 200 PSI maximum
 - Includes (1) standard nozzle, 363148-003

Nozzle Options:

Part Number	Description
363148-002	Pin Stream
363148-003	Cone Pattern Standard
363148-004	Fan Shape Flat



Sure Shot Sprayer Kit - 16 oz.

- Part Number - 363148-001**
- Electroless Nickel Plated Aluminum, w/ Plastic Cap, superior chemical resistance compared to base aluminum
 - Slim design fits in hand easily
 - 200 PSI Maximum
 - Includes extra valve, seal, and nozzle assortment, including: 2 fine, 2 regular, 2 medium, 2 coarse and 1 pin stream nozzle

Nozzle Options:

Part Number	Description
363148-006	Medium Spray
363148-008	Regular Spray (Standard)
363148-009	Coarse Spray



363148-002



363148-003



363148-004



Spray Bottle

Part Number	Sales Unit
365460-004-S	4 empty trigger spray bottles; 32 oz.

Wiper Blades

Crown Part Number	Description	Length	Chevy Express 3500 Cargo Van	Chevy Silverado 3500 Service Truck	Ford Transit T350 Mid-roof Van Left Side	Ford Transit T350 Mid-roof Van Right Side	Chevy Silverado 5500 Truck	Ford F450 Truck	Ford F550 Truck	Ford F600 Truck	Ram 4500 Truck	Ram 5500 Truck
NEW! 300099-010	Premium-Pro	19"				X						
300099-020	Premium-Exact Fit	20"		X								
NEW! 300099-012	Winter Beam-Force	20"				X						
300099-011	Winter Beam-Ice	20"		X		X						
300099-004	Premium-Pro	21"		X			X					
300099-002	Premium-Exact Fit	22"	X	X				X	X	X	X	X
NEW! 300099-009	Premium-Pro	22"	X	X				X	X	X	X	X
300099-001	Standard-Conventional	22"	X					X	X	X	X	X
300099-005	Winter Beam-Ice	22"	X	X			X	X	X	X	X	X
300099-006	Premium-Pro	27"			X							
300099-008	Winter Beam-Force	28"			X							
NEW! 300099-013	Winter Beam-Force	29"			X							

Note: One blade per package.
Windshield washer fluid part number is 300100-101.







Paint

Aerosol Paint Cans - Net wt. 12 oz.

Color	Individual	Case (12 Cans)
Crown 88 Dark Gray	063011-007	063011-017
Crown 94 Medium Gray	063011-008	063011-018
Crown 94 Beige	063011-009	063011-019
Crown Bright Beige	063011-033	063011-034
Crown Medium Silver	063011-037	063011-038
Crown Alpine White	063011-025	
Crown Light Graphite	063011-027	
Crown Crystal Silver	063011-029	
Crown Control Orange	063011-031	
Crown 88 Blue	063011-010	
Crown Motor Silver	063011-035	
Crown 90 Orange	063011-002	
Crown 90 Yellow	063011-021	
Hamech 8782539 Yellow		363018-002
Hamech 8772306 Black		363018-003
Hyster HY1345809 Nugget Yellow		363018-004
Kalmar/Tusk 8776201 Red		363018-001
Komatsu 3EE-97-21110L Blue		363018-012
Komatsu 3ZB-97-21110L Gray		363018-013
Komatsu 3EB-99-A6110 Natural Yellow		363018-019
Komatsu 3EB-99-A6120 Black		363018-003
Komatsu 3EB-99-A6130 Summer Green		363018-018
Komatsu 3EB-99-31120 2K Blue		363018-014
Komatsu 3EB-99-31110 2K Yellow		363018-015
Komatsu 3EB-99-31130 2K Teal Green		363018-016
Raymond 1053174-001 High Gloss Red		363018-010
Raymond 990-181 93 Red/Orange		363018-011
Raymond 990-164 Black		351096-307
Toyota 90900-U9024-71 New Orange		363018-007
Toyota 90900-U9022-71 Black		363018-008
Toyota 90900-U9023-71 Gray		363018-009
Yale 310120350 Bright Gold		363018-005
Yale 310120348 Bright Parchment		363018-006

WARNING: Cancer and reproductive harm - www.P65Warnings.ca.gov

Quart, Gallon and 5 Gallon Paint Cans[#]

Color	Quart	Gallon	5 Gallons
Crown 88 Dark Gray	063016-007	063000-104	063000-040
Crown 94 Medium Gray	063016-008	063000-106	063000-034
Crown 94 Beige	063016-009	063000-108	
Crown Bright Beige	063016-029	063000-105	063000-069
Crown Control Orange		063000-103	
Crown Alpine White	063016-025	063000-151	
Hamech 8782541 Yellow		363017-002	
Hamech 8772305 Black		363017-003	
Kalmar/Tusk 8776201 Red		363017-001	
Komatsu 3EB-99-A6220 Black		363017-003	

[#]Note: Spray equipment required.

WARNING: Cancer and reproductive harm - www.P65Warnings.ca.gov



Adhesive Eraser



Part Number	Description
380030-191	3M Adhesive Eraser Wheel

Easy to use tool for removing adhesives and films from painted surfaces. Will not scratch or damage acrylic enamel or urethane paint. For use with electric drill. Eraser wheel dimensions: 4" x 5/8". Attachment: 3/8".

Paint Area Supplies

ProKnit Premium Tack Cloth*

Part Number	Sales Unit
365479-025-04	4 boxes/case

Constructed of 100% continuous filament polyester. Free of wax, silicones and solvents. Will not streak, mar or cause craters. Antistatic and non-toxic. Mirror-smooth, lint-free finish. Compatible with all quality paints and primers. White. 8.5" x 18". 25/box.



Painter's Tack Cloth*

Part Number	Sales Unit
365481-025-04	4 bags/case

Non-woven material. Very low lint. Low tack for multi-stage paint systems. White. 12" x 17". 25/bag.



Woven Tack Cloth*

Part Number	Sales Unit
365480-001-48	48/case

Made from a woven cloth. Ideal for finishing prior to painting, staining, varnishing and detailing. Tacky surface allows for easy pickup of dust and lint. Individually polybagged. White. 36" x 18".



Nylon Web Scuff Pads*

Part Number	Sales Unit
365502-020	20/box

Durable nylon woven pads for quick scuffing paint, primer and filler. May be used for feathering. Burgundy. 6" x 9". Medium grade/grit.



* Available only to customers in USA

Nitrile, Latex & Vinyl Gloves



Part Number	Description	Size
300075-006	Nitrile, 5 mil, Powder Free, Black	Small
300075-001	Nitrile, 5 mil, Powder Free, Black	Medium
300075-002	Nitrile, 5 mil, Powder Free, Black	Large
300075-003	Nitrile, 5 mil, Powder Free, Black	X-Large
300075-004	Nitrile, 5 mil, Powder Free, Black	XX-Large
300073-001	Latex, 5 mil, Powder Free, Natural	Medium
300073-002	Latex, 5 mil, Powder Free, Natural	Large
300073-003	Latex, 5 mil, Powder Free, Natural	X-Large
300077-006	Vinyl, Powdered, Clear	Small
300077-001	Vinyl, Powdered, Clear	Medium
300077-002	Vinyl, Powdered, Clear	Large
300077-003	Vinyl, Powdered, Clear	X-Large

Note: 100 per package

Nitrile Gloves*

Part Number	Sales Unit	Size
365267-006-10	10 boxes of 100	Small
365267-001-10	10 boxes of 100	Medium
365267-002-10	10 boxes of 100	Large
365267-003-10	10 boxes of 100	X-Large
365267-004-10	10 boxes of 100	XX-Large



Orange. 5 mil. Powder free.

Nitrile Gloves*

Part Number	Sales Unit	Size
365235-001-10	10 boxes of 50	Medium
365235-002-10	10 boxes of 50	Large
365235-003-10	10 boxes of 50	X-Large



Resistant to many chemicals and blood-borne pathogens. Provides more protection than standard nitrile gloves. Industrial grade, latex-free. 8 mil. Single use. Meets FFDC requirements for food contact. 12" length, textured grip.

Latex Gloves*

Part Number	Sales Unit	Size
365248-001-10	10 boxes of 100	Medium
365248-002-10	10 boxes of 100	Large
365248-003-10	10 boxes of 100	X-Large



Heavy duty, industrial grade. 8 mil. Non-sterile. Powder free.

Nitrile Gloves*

Part Number	Sales Unit	Size
365241-003-12	12 pairs	Large
365241-004-12	12 pairs	X-Large



15 mil green nitrile. Nitrile flock, lined. 13" length.

Diamond Grip Latex Gloves

Part Number	Sales Unit	Size
300151-000	100 gloves/box	X-Small
300151-006	100 gloves/box	Small
300151-001	100 gloves/box	Medium
300151-002	100 gloves/box	Large
300151-003	100 gloves/box	X-Large



Better elasticity and puncture resistance. Glove is textured along the length of the fingers for improved grip and thicker at the fingertips for added protection. Palm thickness is 6.3 mils and the finger thickness is 7.9 mils. Chlorinated glove allows for quick donning, particularly in wet environments. Powder-free glove leaves no residue, helping to reduce the risk of spreading bacteria.

Nitrile Foam Coated Gloves*

Part Number	Sales Unit	Size
365236-001-12	12 pairs	Medium
365236-002-12	12 pairs	Large
365236-003-12	12 pairs	X-Large



High-dexterity foam nitrile coated. Gray nylon knit shell. Excellent grip.

Nitrile Grip Industrial Gloves*



Orange Part No.	Black Part No.	Sales Unit	Size
365225-001-10	365225-BK1-10	10 boxes of 100	Medium
365225-002-10	365225-BK2-10	10 boxes of 100	Large
365225-003-10	365225-BK3-10	10 boxes of 100	X-Large
365225-004-10	365225-BK4-10	10 boxes of 100	XX-Large

Heavy weight industrial glove. Deep palm and finger textured for better gripping in wet and dry applications. Cuff: 5 mil. Palm: 8.5 mil. Fingertip: 9 mil. Latex free. Powder free. Standard: Meets ASTM D6319, meets FDA CFR Title 21 Indirect Food Additive Regulations Part 174-178.

Cotton Poly Coated Flex Gloves*

Part Number	Sales Unit	Size
365237-001-12	12 pairs	Medium
365237-002-12	12 pairs	Large
365237-003-12	12 pairs	X-Large



Excellent abrasion resistance with a high level of dexterity. Heavy latex with textured palm and fingers. String knit, palm dipped in latex, knit wrist.

Polyurethane-Coated, Nylon Knit Gloves*

Part Number	Sales Unit	Size
365228-006-12	12 pairs	Small
365228-001-12	12 pairs	Medium
365228-002-12	12 pairs	Large
365228-003-12	12 pairs	X-Large
365228-004-12	12 pairs	XX-Large



Polyurethane palm coating is tough and durable. Gray nylon knit shell. Durable, but still allows for excellent tactile feel.



Nitrile Grip Light Weight Gloves*



Orange Part No.	Black Part No.	Sales Unit	Size
365225-L01-10	365225-LB1-10	10 boxes of 100	Medium
365225-L02-10	365225-LB2-10	10 boxes of 100	Large
365225-L03-10	365225-LB3-10	10 boxes of 100	X-Large
365225-L04-10	365225-LB4-10	10 boxes of 100	XX-Large

Light weight high dexterity glove. Heavy palm and finger textured for better gripping in wet and dry applications. Length: 9.5" Thickness: 6 mil. Latex free. Powder free. Standard: Meets ASTM D6319, meets FDA CFR Title 21 Indirect Food Additive Regulations Part 177.

* Available only to customers in USA

Cotton Jersey Gloves*

Part Number	Sales Unit	Size
365240-012	12 pairs	One Size

General duty. Can be used alone or as glove liners. Brown cotton jersey. Knit cuff.



Welding Gloves*

Part Number	Sales Unit	Size
365473	1 pair	One Size

Economy welding glove. 13" length. Fully cotton lined and welted cowhide.



ProWorks® PVC Dotted String Knit Gloves*

Part Number	Sales Unit	Size	Dots
365491-012	12 pairs	One Size	1 side
365492-012	12 pairs	One Size	2 sides

Medium weight cotton/poly blend string knit. Breathable. PVC dots increase gripping tactility. Good warehouse glove.



Drivers Gloves*

Part Number	Sales Unit	Size
365242-002-12	12 pairs	Medium
365242-003-12	12 pairs	Large
365242-004-12	12 pairs	X-Large

Select pigskin drivers gloves. Shirred back. Keystone thumb. Unlined.



Foam Nitrile Coated Cut Resistant Gloves*

Part Number	Sales Unit	Size
365229-001-12	12 pairs	Medium
365229-002-12	12 pairs	Large
365229-003-12	12 pairs	X-Large
365229-004-12	12 pairs	XX-Large

13 gauge High Performance Polyethylene (HPPE) provides cut resistance. Foam nitrile palm dip provides protection from abrasion in wet or dry conditions. Seamless design provides a comfortable fit. Meets EN 388:2003 standards for Abrasion Resistance, Blade Cut, Tear, and Puncture (4 5 4 3). ANSI cut level 4, CE cut level 5.



Mechanics Insulated Gloves*

Part Number	Sales Unit	Size
365471-001	1 pair	Medium
365471-002	1 pair	Large
365471-003	1 pair	X-Large

High dexterity mechanics gloves. Full fingertip and knuckle protection. Insulated with 3M thinsulate. Adjustable velcro closure & padded palm.



Full Latex Coated Waterproof Gloves*

Part Number	Sales Unit	Size
365227-001-12	12 pairs	Medium
365227-002-12	12 pairs	Large
365227-003-12	12 pairs	X-Large
365227-004-12	12 pairs	XX-Large

13 gauge orange nylon shell. Full latex, waterproof coating. Black sandy foam palm dip. Good abrasion resistance. Elastic wrist. Tested to EN388:2015 standards for Abrasion Resistance, Blade Cut, Tear and Puncture (3 1 3 1).



Dewalt® Performance Mechanic Gloves*

Part Number	Sales Unit	Size
365490-002	1 pair	Large
365490-003	1 pair	X-Large

Impact guards help protect incidental bumps or scrapes while maintaining flexibility and comfort. SecureFit™ wrist closure. Tacky silicone fingertip grips. TPR impact guards. PVC palm and saddle overlays. Durable rubber pull tab.



Neoprene Over Latex Gloves*

Part Number	Sales Unit	Size
365239-002-12	12 pairs	Large
365239-003-12	12 pairs	X-Large

Heavyweight neoprene over latex, flock lined - 28 mil. Chemical/oil resistant. Outstanding dexterity. Impermeable to gases, vapor and moisture.



Crown Mechanics Gloves

Part Number	Description	Size
300094-001	Integrity Service Black	Medium
300094-002	Integrity Service Black	Large
300094-003	Integrity Service Black	X-Large

Lightweight, yet durable for the toughest tasks. Synthetic leather palm extends life of the glove while the spandex back provides breathability. Reinforced fingertips for maximum durability. Easy slip-on, open cuff design. Sold by the pair.



Leather Palm Gloves*

Part Number	Sales Unit	Size
365238-012	12 pairs	Large
365238-003-12	12 pairs	X-Large

Made from select shoulder leather. Leather palms, fingers and knuckle strap. 2 1/2" rubberized safety cuff. Safety Orange back and cuff.



* Available only to customers in USA

Gloves

QuickPick® Transceiver Gloves

Part Number	Sales Unit	Size	Transceiver Module Placement
152892-009	1 pair	Small	Left hand
152892-010	1 pair	Medium	Left hand
152892-004	1 pair	Large	Left hand
152892-005	1 pair	X-Large	Left hand
152892-006	1 pair	XX-Large	Left hand
152892-007	1 pair	Small	Right hand
152892-008	1 pair	Medium	Right hand
152892-001	1 pair	Large	Right hand
152892-002	1 pair	X-Large	Right hand
152892-003	1 pair	XX-Large	Right hand

Crown Mechanics Fingerless Gloves with QuickPick Transceiver holder on the back of one glove.



Crown Mechanics Fingerless Gloves

Part Number	Sales Unit	Size
152892-014	1 pair	Medium
152892-011	1 pair	Large
152892-012	1 pair	X-Large
152892-013	1 pair	XX-Large

Cow grain leather palm extends life of the glove while the spandex back provides breathability. Fingerless, double stitched for maximum durability. Velcro wrist closure.



Industrial Wiping Products

Continued ▶

Flat Bulk Materials & Quarter Fold



Part Number	Sales Unit
365211-040-18 *	18 packages/case

Leading all-purpose wiper. Highly absorbent. Soft, cloth-like feel. Compare to KC Wypall® L40. White. ¼ fold. 12.5" x 13". 56 sheets in package.



Part Number	Sales Unit
365215 *	Approximately 1650/case

Smooth. Hydroknit irregulars. 25 lb. bulk. White or colors. 10" or 12" x 15".



Part Number	Sales Unit
365213 *	Approximately 1700/case

Leading grease and oil wiper. Excellent for any type of automotive clean-up. Soft and thick. Highly absorbent with grease and oil. White. Flat packed. 15" x 13".

Woven Wiping Materials



Part Number	Sales Unit
365220-012 *	12/case

Cleans without harmful chemicals. Use wet or dry. Non-abrasive, non-linting microfiber. Machine washable. Blue. 16" x 16".



Part Number	Sales Unit
365478-050 *	50 lbs./case

Terry towel - irregular. Mostly cotton. Will vary in size and color within each case. Highly absorbent and becomes even more absorbent after laundering. 20" x 20" to 26" x 26".



Part Number	Sales Unit
365221-500 *	500/case

100% cotton shop towel. High absorption capability. Used for many grease and oil applications. A popular towel among mechanics. Red. 18" x 18".



Part Number	Sales Unit
365223-050 *	50 lbs./case

Mostly cotton T-shirt towel. Excellent for cleaning, polishing and staining. Light to medium weight material. Soft and low linting. Towels compressed into heavy gauge polybags for shipping and storage. Un-washed material. Gray 12" x 18" to 24" x 24".



Part Number	Sales Unit
365222-025 *	25 lbs./case

Mostly cotton hand towel. Will vary in size and color within each case. High absorbent and becomes even more absorbent after laundering. 14" x 24".



Part Number	Sales Unit
365224-050 *	50 lbs./case
365476-050 *	10 - 5 lb. packs/case

Mostly cotton recycled knit T-shirt. Washed. Resists bleeding. Packaged in Spaceworks bag to reduce shipping costs. Inexpensive alternative to rental rags. Some may have screen printing. Shades of gray.

Part Number	Sales Unit
365477-025 *	25 lbs./case

New rinsed Huck Towels. 100% cotton fully hemmed and folded. Never used & uncontaminated. Has not undergone harsh chemical exposure to rid it of biological agents. Blue. 16" x 26".

* Available only to customers in USA

Pop-Up Wipers



Part Number	Sales Unit
365201-800-06*	6 boxes/case

Extremely durable, made with Hydrospun Technology. Reusable, long-lasting performance. Similar to red cloth shop towels but disposable. Compare to KC X80 red. Red, 8.25" x 16.75", 100 sheets in a box.



Part Number	Sales Unit
323015-000-08	8 boxes/case

Economy wiper. Comparable to WypAll® L40 series of wipes. White, 9.2" x 16.5". 100 sheets in a box.



Part Number	Sales Unit	Sheet Size
365201-700-10*	10 boxes/case	8.25" x 16.75" 100 sheets/ box
365482-700-08*	8 boxes/case	16" x 12.75" 150 sheets/box

Durable, made with Hydrospun Technology. Excellent tear strength. Solvent resistant. Superior wipe-dry. Ideal for manufacturing, maintenance, transportation & hi-tech areas. Compare to KC Wypall® X70. White. Two wiping towel sizes to meet your needs.

365201-700-10



365482-700-08



Part Number	Sales Unit
323014-000-08	8 boxes/case

Standard wiper. Comparable to WypAll® X60 series of wipes. White, 9.5" x 16.5". 126 sheets in a box.



Part Number	Sales Unit
365201-030-09*	9 boxes/case

Lightweight general purpose wiper. Soft enough to use as a personal wiper. Easily absorbs liquids, lubricants and oils. Compare to KC Wypall® L30. White. 9" x 16.75". 120 sheets in a box.



Part Number	Sales Unit	Sheet Size
365201-600-10*	10 boxes/case	8.25" x 16.75" 125 sheets/ box
365483-600-08*	8 boxes/case	16" x 12.75" 180 sheets/box

Durable, low lint, made with Hydrospun Technology. Excellent shop towel replacement. Ideal for manufacturing, general maintenance & transportation. Resistant to most solvents. Compare to Wypall® KC X60. White. Two wiping towel sizes to meet your needs.

365201-600-10



365483-600-08



Part Number	Sales Unit
365201-010-18*	18 boxes/case

High quality, for everyday tasks. Compare to KC Wypall® L10. White, 2-ply. 9" x 10.3". 110 sheets in a box.



Part Number	Sales Unit	Sheet Size
365201-000-06*	6 boxes/case	16.75" x 9" blue 150 sheets/ box
365484-000-06*	6 boxes/case	16.75" x 9" white 150 sheets/box

Premier wiping cloth for low lint applications - creped finish. Excellent for the final wipe in painting applications. Low lint. Made with Hydro-Entangled binder free technology. Superior wipe-dry properties. Solvent resistant. Excellent tear strength.

365201-000-06



365484-000-06



Part Number	Sales Unit
365201-050-09*	9 boxes/case

Excellent general purpose wiper. Durable and strong. Packaging allows for wipers to be contained and portable. Can be assigned to worker to help control over usage. Compare to KC Wypall® X50. Blue. 8.25" x 16.75". 100 sheets in a box.



Part Number	Sales Unit
365212-050-08*	8 boxes/case

Excellent general purpose wiper. Durable and strong. Packaging allows for wipers to be contained and portable. Can be assigned to worker to help control over usage. Compare to KC Wypall® X50. White, 10" x 11.5". 275 sheets in a box.

*Available only to customers in USA

Jumbo Roll / Small Roll Wipers



Part Number	Sales Unit
365202-800-03*	3 rolls/case

Heavy-duty absorbency and maintains strength in solvents & other liquids. Made with Hydrospun Technology. Durable wiper for extended cleaning performance. Reusable, long-lasting performance. High capacity Jumbo Roll helps control waste. Compare to KC Wypall® X-80 Jumbo Roll. Red, perforated. 12.5" x 12". 500 sheets on a roll.



Part Number	Sales Unit
365202-700-03*	3 rolls/case

Heavy-duty absorbency and maintains strength in solvents & other liquids. Made with Hydrospun Technology. Durable wiper for extended cleaning performance. Reusable, long-lasting performance. High capacity Jumbo Roll helps control waste. Compare to KC Wypall® X-70 Jumbo Roll. White, perforated. 12" x 12.88". 870 sheets on a roll.



Part Number	Sales Unit
365202-600-03*	3 rolls/case

Made with Hydrospun Technology. Medium-duty absorbency and strength in solvents and other liquids. Durable wiper for extended cleaning performance. Reusable, long-lasting performance. High capacity Jumbo Roll helps control waste. Compare to Wypall® X-60 Jumbo Roll. White, perforated. 12" x 12". 1100 sheets on a roll.



Part Number	Sales Unit
365202-040-03*	3 rolls/case

Excellent general purpose wiper. Durable and strong. High capacity Jumbo Roll helps control waste. Compare to Wypall® L-40 Jumbo Roll. White, perforated. 12" x 12.5". 750 sheets on a roll.



Part Number	Description
365203-001*	Dispenser, wall mount

Holds 1 Jumbo Roll. Mount on wall in work station. Blue. Metal.



Part Number	Description
365203-002*	Dispenser, floor mount

Holds 1 Jumbo Roll. Mobile floor mount for use in work station. Blue. Metal.



Part Number	Sales Unit
365204-040-30*	30 rolls/case

Excellent general purpose wiper. Durable and strong. Small roll can be used in standard household paper towel dispenser. Perforated sheets. Blue. 11" x 9.375". 55 sheets on a roll.



Part Number	Sales Unit
365210-040-30*	30 rolls/case

Excellent general purpose heavy duty wiper. Medium weight, durable and strong. Soft enough for hands and face, yet durable and strong enough for most industrial wiping applications. Small roll can be used in standard household paper towel dispenser. Perforated sheets. Individually wrapped. White. 11" x 9". 55 sheets on a roll.



Part Number	Sales Unit
365205-010-30*	30 rolls/case

Soft task white kitchen roll towel. General purpose. Fits all standard roll towel dispensers. Light weight. Rolls are individually wrapped. Premium quality for softness and absorption. White. 8.8" x 11" sheet size. 85 sheets per roll.

Centerfeed Towels



Part Number	Sales Unit
365206-002*	2 rolls/case

Excellent general purpose wiper. Durable and strong. Centerfeed rolls. Fits standard center pull dispensers. White. 9" x 13". 200 sheets on a roll.



Part Number	Sales Unit
365207-040-08*	8 rolls/case

Excellent general purpose wiper. Durable and strong. Centerfeed rolls. Fits standard center pull dispensers. Blue, perforated. 9" x 15". 275 feet on a roll.



Part Number	Sales Unit
365208-006*	6 rolls/case

100% cellulose. Excellent mechanics wipe. Centerfeed towel dispensing. Two-ply. A low lint light duty wiper. White, perforated. 7.6" x 12". 600 sheets on a roll.



Part Number	Sales Unit
365344-006*	6 rolls/case

SCA Tork® White Advanced Centerfeed Towels. Perforated, highly absorbent towels dispense easily with one-at-a-time service for source reduction. Made from 100% recycled fiber. EcoLogo certified. Two-ply. 8.3" x 11.8". 610 sheets on a roll.



Part Number	Description
365209*	Centerfeed dispenser

Southern Soft® Center Pull Dispenser. Adjustable nozzle accepts a wide range of center pull towels. Easy loading; built-in level on back of dispenser for quicker mounting. All center feed towels listed above fit in this dispenser. Color is black/carbon translucent. 12.4" x 10" x 10.12".

* Available only to customers in USA

Industrial Wiping Products

Hand Towels



Part Number	Sales Unit
365340-150-16*	16 packs/case

C-Fold towels are soft, strong and absorbent. Made from 100% recycled fiber - EcoLogo Certified. White. 12 $\frac{1}{4}$ " x 10 $\frac{1}{8}$ ". 150/pack.



Part Number	Sales Unit
365352-250-16*	16 packs/case

Multi-fold Towels. Excellent drying capacity which reduces consumption. Each towel is dispensed individually for better hygiene. Ideal solution for a multitude of hand drying applications. White. 9.5" x 9". 250/pack.



Part Number	Sales Unit
365353*	16 packs/case

Southern Soft™ Multi-fold Dispenser. High capacity single serve dispensing. Adaptable to accommodate proprietary product size. Ideal solution for a multitude of hand drying applications. Accepts C-Fold, M-Fold and fits product size up to 10.125" in width. Includes a permanent turn-knob key that stays in the dispenser for low security locations and maintenance key for personnel. 15.89" H x 11.76" W x 5.34" D; built-in level on back of dispenser for quicker mounting.



Part Number	Sales Unit
365342-250-16*	16 packs/case

Multi-Fold towels are soft, strong and absorbent. Made from 100% recycled fiber - EcoLogo Certified. White. 9 $\frac{1}{2}$ " x 9 $\frac{1}{16}$ ". 250/pack.

Drape Material/Fender Covers



Part Number	Sales Unit
365226-072*	72 sheets/case

Treated material repels liquids. Economy drape material. Can be used as an outdoor cover, fender cover or floor/carpet protection. Blue/green. 6' x 41".

* Available only to customers in USA

Can Liners

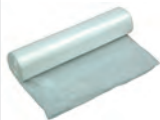

Part Number	Description
365400-010-20*	6 micron; 7-10 gallons, 24" x 24", 50/roll; 20 rolls/case
365400-012-20*	6 micron; 12-16 gallons, 24" x 33", 50/roll; 20 rolls/case
365400-020-20*	10 micron; 30 gallons, 30" x 37", 50/roll; 10 rolls/case
365402-060-08*	14 micron; 60 gallons; 38" x 60". 25/roll; 8 rolls/case

High density. High tensile strength. Very little stretch, Regular use. Natural.

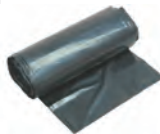

Part Number	Description
365400-056-08*	19 micron; 56 gallons; 43" x 48". 25/roll; 8 rolls/case

High density. High tensile strength. Very little stretch, Extra heavy use. Black.

* Available only to customers in USA



Part Number	Description
365401-045-01*	1 mil; 40-45 gallons, 40" x 46", 20/roll, 5 rolls/case
365401-056-01*	1 mil; 56 gallons, 43" x 47", 20/roll, 5 rolls/case
365401-033-01*	1.2 mil; 33 gallons, 33" x 39", 20/roll, 10 rolls/case
365401-040-01*	1.5 mil; 40-60 gallons, 40" x 46", 20/roll, 5 rolls/case
365401-060-01*	1.5 mil; 55 gallons, 38" x 58", 20/roll, 5 rolls/case
365401-062-01*	2 mil; 55 gallons, 38" x 58", 10/roll, 10 rolls/case

Linear low density. Stretch, Extra heavy weight. Black.



Part Number	Description
365401-042-01*	3 mil; 42 gallons, 33" x 48", 32/roll, 1 roll/case
365401-055-01*	3 mil; 55 gallons, 36" x 56", 15/roll, 1 roll/case

Linear low density. Stretch, Premium heavy weight. Black.

Cable Ties

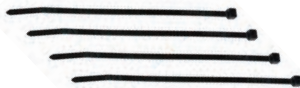

Part Number	Length (in)	Width (in)	Maximum Wire Bundle	Color	Qty Per Box
365003-002	3.62	0.09	0.63	Natural	1000
365003-003	7.44	0.19	1.75	Natural	1000
365003-004	5.60	0.14	1.38	Black	1000
365003-005	11.40	0.14	3.00	Black	1000
18108-X	14.00	0.3125	4.00	Black	100

Floor Mats



Note: see Tools Section, page 9.04, for Crown Bar Stools.



Crown Branded Mats

Part Number	Size
368200-001	2' x 3'
368200-002	3' x 5'
368200-003	4' x 6'
368200-004	3' x 10'

Use the Crown branded mats to make a lasting impression to your customers. Static dissipative nylon yarn treated with StainStopper™ Technology. 100% nitrile rubber backing for increased slip and resistance. Certified High-Traction by the National Floor Safety Institute.

Tough Rib Floor Mat

Dirt-trapping design is uniquely built for heavy-traffic and high soil areas. Extra coarse polypropylene fibers stand up to demanding use. Vinyl backing and borders. Can be cleaned by vacuuming, sweeping or hosing.

Part Number	Size	Color
368200-202	3' x 5'	Charcoal
368200-203	4' x 6'	Charcoal
368200-204	3' x 10'	Charcoal



Tire Tuff Royale High-Traffic Entrance Mat

Heavyweight floor mat designed for busy traffic areas – inside or out. Crush-resistant bi-level surface removes debris and moisture from passing shoes. Dual-fiber needle-punch mats dry quickly and resist staining and fading. Molded rubber backing for durability. Product contains 50% total recycled content.

Part Number	Size	Color
368200-302	3' x 5'	Onyx

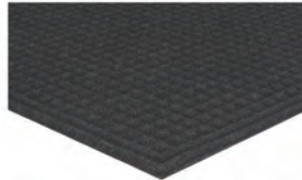

Unifirst Great Impressions 2.0 Walk-Off Floor Mat

Heavy-duty, nylon-tufted mat with stay-put "hugger" backing. Dense rubber back helps mat stay in place, reduce flex and improve durability. Absorbent surfaces trap and hold up to a gallon of water per square yard. Heavier weight helps hold mat in place and reduce potential for "flip-ups".

Part Number	Size	Color
368200-102	3' x 5'	Grey
368200-103	4' x 6'	Grey
368200-104	3' x 10'	Grey

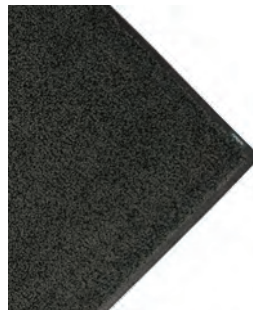

Double Coated Tape

Part Number	Description
061000-002	5 mil, 1" x 36 yds - 3M #410M

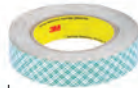

Utilizes a natural rubber adhesive system that offers good to excellent adhesion to many types of surfaces. Good holding power to a wide variety of materials. Low temp -40, high temp 200. Used on C5, SC45 & FC45 seats.

Industrial Strapping Tape

Part Number	Description
061000-003	½" x 180' - 3M #898



Reinforces corrugated and fiberboard boxes. Tackles heavy duty sealing and bundling. Recommended for "L" clip closures and "C" clip reinforcements. Excellent abrasion, moisture and scuff resistance. Clear polypropylene backing reinforced with glass yarn filaments. Synthetic rubber adhesive.

3.5 Mil Transparent Polyester Film

Part Number	Description
061000-004	¾" x 72 yds - 3M #57
061000-005	1" x 72 yds - 3M #57



Rubber adhesive, supplied on 3" core. Is suited for use as a coil cover, layer insulation and capacitor wrap where higher electrical strength is desirable. Color is yellow. Temperature class 266°F/ 130°C. Used on coil in contactor.

Acetate Black Cloth Tape

Part Number	Description
061000-006	7 mil, ¾" x 72'



This tape offers excellent conformability in coil wrapping applications up to 105°C, 221°F. Acetate cloth tape offers excellent absorption of resins and varnishes. Printable. Used on coil in contactor.

Black Fusion Tape

Part Number	Description
061000-015	1" x .020" x 30' - Amp 605980-2

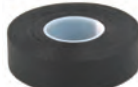

Fusion Tape is very easy to use and is ideal for wrapping electrical cable splices and terminations. It provides neat, trim, long-lasting insulation on a wide range of sizes, shapes, and materials. Applications are mostly electrical but Fusion Tape can be used in a wide variety of areas. This durable, black elastic tape has excellent electrical properties, water resistance, ozone resistance, and corrosion resistance at temperatures ranging from (-40°C) to 212°F, (100°C) continuous, and to 266°F (130°C) for short periods of time.

⚠️WARNING: Cancer and reproductive harm - www.P65Warnings.ca.gov

Electrical Tape

Part Number	Description
380030-053	7 mil, ¾" x 60'



Suitable for use at not more than 600 V and not more than 176°F (80°C). UL rated.

Masking Tape*

Part Number	Description	Sales Unit
365406-024	5.1 mil, 2" x 60 yds	24 rolls/case

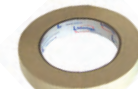

Industrial grade, general purpose masking tape for everyday needs. Used for masking, packaging, bundling and labeling. Off white.

3M Super 33 Electrical Vinyl Tape

Part Number	Description
323009	7 mil, ¾" x 66'



Flame retardant, hot and cold weather resistant. Resists UV rays, abrasion, moisture, alkalis, acids and corrosion. Used as a primary insulation for wire cable splices up to 600V and for fixture and wire splices up to 1000V. Black.

3M Super 88 Electrical Vinyl Tape

Part Number	Description
323010	8.5 mil, ¾" x 66'



Flame retardant, hot and cold weather resistant. Resists UV rays, moisture, alkalis, acids and corrosion. Superior cold weather handling and conformability. Extra thickness provides added electrical properties, quicker insulation build up and abrasion resistance. Black.

Yellow Painters Tape - Paint Shop Quality*

Part Number	Description	Sales Unit
365422-001	5.7 mil, .75" x 55 yds	1 roll
365422-002	5.7 mil, 1.5" x 55 yds	1 roll
365422-003	5.7 mil, 2" x 55 yds	1 roll



Superior waterproof and UV resistant tape. Fits baking cycles up to 230°F for 6 minutes. Permits 10-15 day clean removal. Sticks instantly to most surfaces including metal, rubber and plastic. Delivers high sharp paint lines. Designed for indoor & outdoor use. Yellow color.

Blue Painters Tape*

Part Number	Description	Sales Unit
365408-024	5.6 mil, 1.5" x 60 yds	6 rolls/case



Low adhesion painters tape, acrylic-based adhesive. Not for body shop use. Removes cleanly from cured painted walls, trim, woodwork, glass and metal for up to 14 days without damage to the substrate even when exposed to direct or indirect sunlight.

Duct Tape*

Part Number	Description	Sales Unit
365409-006	9 mil, 2" x 60 yds	6 rolls/case

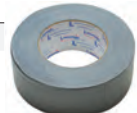

Has a strong poly-coated cloth backing. Excellent product to use to fix, repair, patch and seal. Sticks instantly in high and low temperatures. Silver. Individually wrapped.

Carton Sealing Tape*

Part Number	Description	Sales Unit
365410-024	1.9 mil, 3" x 110 yds	24 rolls/case
365411-036	1.9 mil, 2" x 110 yds	36 rolls/case

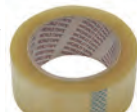

Sticks instantly to most surfaces. Conformable with smooth, easy release. Clear polypropylene with acrylic adhesive. Hot melt.

*Available only to customers in USA

Tape/Packaging

Tape Dispenser*

Part Number	Description
365414	Tape dispenser

Holds 48mm x 110 yds (2" x 110 yds) roll. Adjustable tension brake.



Tape Dispenser

Part Number	Tape Width
351097-365	2"

Dispenses 2" tape. Adjustable spool accommodates large rolls. Blade guard protects hands and helps place tape onto box or envelope.



Shrink Wrap, Small Rolls*

Part Number	Description	Sales Unit
365405-018	90 gauge, 3" x 1000'	18 rolls/case

Polyethylene-cast stretch film. Exceptional load holding force. Superior cling and tear resistance in a wide variety of applications. **Faster and more economical to use than tape or strapping.** Includes handle.



Shrink Wrap*

Part Number	Description	Sales Unit
365405-004	80 gauge, 18" x 1500'	4 rolls/case
365405-004-36	80 gauge, 18" x 1500'	36 cases/pallet

Polyethylene-cast stretch film. Exceptional load holding force. Superior cling and tear resistance in a wide variety of applications. **Faster and more economical to use than tape or strapping.**



Quick Change Utility Knife and Blades*

Part Number	Description	Sales Unit
365412-006	Utility Knife	6 knives
365413-100	Replacement Blades	100 blades

Bi-metal Irwin blades stay sharp three times longer than ordinary blades and are unbreakable under normal working conditions. Smooth, durable, three-position slide exposes variable blade lengths and stands up to frequent use. Push-button offers easy access to interior blade storage. Fully retractable blade for safety. Built-in twine cutter. Includes one blade.



*Available only to customers in USA

Chemicals - Adhesives

Continued ▶

Devcon Zip-Grip #4044 - Instant Adhesive

Part Number	Sales Unit
061001-004	Net wt 1/2 oz or 14 gram Bottle

Suitable for bonding plastics, rubber, metals and dissimilar substrates. Adhesive fixes in seconds and provides a durable bond. Resistant to aging and weathering. Low viscosity for close fitting parts. Use on grommets and pedal pads.



3M Fastbond 30NF Adhesive

Part Number	Sales Unit
061001-021	Quart

Water-dispersed high-strength contact adhesive. Has high coverage, a long bonding range, and good heat resistance. Can be used to bond foamed plastics, plastic laminate, wood, plywood and wood veneer, and canvas to themselves and each other, as well as for post-forming operations. Non-flammable in the wet state. Neutral color. Used on foot pedals along with 061001-004. Also used on plastic grommets, seal strip extrusion like in the steering on SC and screws.



Permabond HM128 Threadlocker

Part Number	Sales Unit
061001-012	250 ml Bottle

High strength adhesive for permanent assembly. Used for preventing vibration loosening of bolts, studs and cap screws. Replaces lock washers. Full cure at room temperature. Provides corrosion protection. Red in color.



Heron Instant Bond 113 - General Purpose

Part Number	Sales Unit
061001-007	Net wt 1 oz Bottle

This thin liquid is suitable for close tolerance bonding of a wide variety of materials. Used on self tapping screws.



Super Bonder 498 Thermal Cycling Resistant - Instant Adhesive

Part Number	Sales Unit
061001-022	Net wt 1 oz Bottle

A medium viscosity, high temperature product for all metals, and most plastics and rubbers. Resists temperatures to 223 F continuous or up to 250 F intermittent. Used on thermal sensor on lift and drive motors.



Chemicals - Adhesives



3M Scotch Grip 1099 - Plastic Adhesive

Part Number	Sales Unit
061001-018	Net wt 5 oz Tube

Excellent for bonding most vinyl extrusions and sheeting. Also bonds many fabrics and foams. Note: it may stain light colored, flexible vinyls; check before using. It is not recommended for bonding polyethylene or polypropylene. Meets MIL-A-13883B, Type I and MMM-A-189C, Class 2. Used on felt seals like on caster brake assembly on reach trucks.



Jowat Laminating Adhesive

Part Number	Sales Unit
363600	9 lb jug

Laminating Adhesive - PVA Water based primer suitable for solid woods & high pressure laminates. Plastic film lamination / Primer for HPL. Used on rubber mats and grommets.



3M Super Weatherstrip and Gasket Adhesive

Part Number	Sales Unit
061001-023	Net wt 2 oz Tube

Yellow in color - A strong, flexible, rubbery adhesive that can withstand vibration and extreme temperature variations. It can be used to bond automotive weatherstripping and is a great adhesive for holding paper, cork, or rubber gaskets in place during installation. Used to glue wear strip on quick adjust casters.



TRA-BOND 2143D

Part Number	Sales Unit
061001-020	6 cc

A medium viscosity adhesive recommended for industrial bonding and sealing applications where toughness, impact resistance, and superior mechanical properties are required. This two-part adhesive is easily mixed and cured at room temperature, and develops strong bonds to most clean, dry material surfaces including most metals, rigid plastics, glass, ceramics, leather, rubber, wood and concrete. Fully cured TRA-BOND 2143D bonds offer good low-temperature electrical, mechanical, and impact resistant properties, superior thermal shock resistance, low permeability to gases and vapors, good dimensional stability, and resistance to water, weather, oxygen and ozone, most petroleum products, mild acids and alkalis, and many other chemicals. Used on buttons and inserts like in the control handle.



3M 1300 Rubber and Gasket Adhesive

Part Number	Sales Unit
061001-015	Net wt 5 oz Tube

Yellow, versatile, heat resistant and adheres to metal and wood. A yellow, premium quality, versatile, brushable, heat resistant adhesive that develops strength rapidly. Has excellent adhesion to metal, bake enamel, wood, most plastics, and neoprene, reclaim, SBR, and butyl rubber. NOT for EPDM rubber. Used on felt seals, poly pads, and grommets.

Chemicals - Retaining Compounds



Turbo Fuse Instant Bonding Super Glue

Part Number	Sales Unit
061001-024	Net wt 16 oz Bottle

Used on floormats. Comes with nozzle.

Loctite Retaining Compounds

Part Number	Sales Unit	Description
061004-027	0.5 ml	Loctite 680 - Slip Fit
061004-021	250 ml	Loctite 680 - Slip Fit
061004-022	50 ml	Loctite 680 - Slip Fit
061004-025	0.5 ml	Loctite 609 - Press Fit
061004-009	10 ml	Loctite 609 - Press Fit



Chemicals - Lubricants



O-Ring and Valve Lubricant / Sealant

Part Number	Sales Unit
063002-020	Net wt 5.3 oz Tube

Used as a lubricant for rubber and plastic o-rings, water softener and faucet valves, valve stems for potable water, aircraft vacuum systems, electronic and ignition systems. Used as a sealant in applications such as vacuum and pressure systems, equipment subject to washing and harsh environments, electrical service entrances and underground connections, and transformer gaskets and equipment enclosures. Used on Wave traction pod on torsion springs, FC4 compression spring on park brake switch, spacer in Wave clip pad.



Nygel Contact Lubricant

Part Number	Sales Unit
127189-001	55 cc

Recommended lubricate for pins and sockets of GE EV100/200 and GenII products.



G-n Metal Assembly Spray

Part Number	Sales Unit
063002-021	Net wt 11 oz Can

Contains MoS₂. Reduces galling and seizing. Use for cutting and shearing, drills and taps, metal fabricating, metal forming, press fitting, and running-in. Used on threaded shaft in servo control valve and spacer in height sensor.

⚠️WARNING: Reproductive Harm - www.P65Warnings.ca.gov



Permatex 133K Anti-Seize Lubricant

Part Number	Sales Unit
065005-003	Net wt 8 oz Bottle

Heavy duty, formulated not to evaporate and harden, contains a heavy-duty blend of aluminum, copper and graphite. Designed to prevent galling, corrosion and seizing of mated parts. Withstands salt, corrosion and moisture. For use in assemblies up to 1600°F (871°C). Meets Mill Spec #907E.

Chemicals - Insulator



Silicone Dielectric

Part Number Sales Unit

063002-018 | Net wt 5.3 oz Tube

Insulator and bushing flashover protection. Good resistance against oxidation, moisture, and salt spray.



Electrical Insulating Compound

Part Number Sales Unit

063002-019 | Net wt 5.3 oz Tube

Contains silicone. Provides moisture barrier. -70° F to 400° F. Applications: Electrical assemblies and terminals, cable connectors, battery terminals, and rubber and plastic o-rings.

Chemicals - Heat Sink Compounds



Silicone Heat Sink Compound

Part Number Sales Unit

063002-029 | Net wt 5.0 oz Tube

Thermal coupling of electrical/electronic devices to heat sinks. High thermal conductivity, low bleed, stable at high temperatures. White grease-like silicone heavily filled with heat-conductive metal oxides. Used on Access II & III traction control modules.



Heat Sink Compound

Part Number

093983

Extra high-efficiency heat transfer compound. Used on heat sink assemblies, SCR panels, contactor panels and freezer heaters and limit switch assembly.

Chemicals - Sealants



Primer

Part Number Sales Unit

061004-002 | Net wt 4.5 oz Can

Loctite 7471 Locquic Primer T - Increases cure speed of Loctite anaerobic products. Especially recommended for applications with passive metals or inert surfaces and with large bond gaps. Use of activator is particularly recommended for cure conditions below 15° C.



Primer

Part Number Sales Unit

061004-016 | Net wt 4.5 oz Can

Loctite 7649 Primer N - a solvent-based primer that features very long on-part life. Use to speed the cure of all Loctite Anaerobic Products and ensure proper cure on inactive metals. Ideal for cure conditions below room temperature.



Liquid Gasket

Part Number Sales Unit

Description

061004-030	50 ml	Loctite 518 (Gasket Eliminator-preferred sealant for aluminum flanges)
061004-015	300 ml	
323018	50 ml	Loctite 515 (Medium strength, for machined metal flanges and gaps up to 0.25 mm; 30 minute fixture time)
323018-001	300 ml	



Gasket Maker

Part Number Sales Unit

363007-001 | 7 oz
363007-003 | 3 oz

Permatex 85224 Powerbead The Right Stuff Instant Rubber Gasket Maker. The Right Stuff is blowout resistant and outperforms pre-cut gaskets. Protects against leaks caused by vibration and thermal expansion. Temp Range -75°F to 450°F continuous, 500°F intermittent and is Sensor-Safe.



Loctite Flange Sealant

Part Number Sales Unit

805044 | 50 ml

Fast curing, provides resistance to low pressures immediately after assembly of flanges.



Security Sealant

Part Number Sales Unit Seal Type

065102-002 | 1 oz | Sentry Seal

Used to visually detect any movement in the adjustment of parts. Used on compression fittings, studs, nuts, parts and assemblies after they have been set to proper tension or position. Inspectors can visually detect any movement or tampering.

Thread Locker

Part Number Sales Unit Description

061004-019	0.5 ml	Loctite 271 high strength
061004-010	10 ml	Loctite 271 high strength
061004-026	0.5 ml	Loctite 242 medium strength
061004-012	10 ml	Loctite 242 medium strength
061004-020	10 ml	Loctite 222 low strength
061004-018	250 ml	Nuts'n bolts 420 low strength
061004-028	20 g	Loctite 425 instant adhesive - assure surface curing
323013	6 ml	Medium strength blue



⚠️WARNING: Cancer and reproductive harm - www.P65Warnings.ca.gov

Loctite Thread Sealant

Part Number Sales Unit Description

061004-011	50 ml	Loctite 569 - high strength hydraulic sealant
061004-023	50 ml	Loctite 565 - PST pipe sealant
061004-029	250 ml	Loctite 565 - PST pipe sealant
061004-014	10 ml	Nuts'n bolts 431 - fast cure, penetrating, preassembled parts



Release Compound

Part Number Sales Unit

063002-033 | Net wt 5.3 oz Tube

Non-curing release agent. Applications: mold release agent, mold break-in, release agent for adhesives, release agent for plastic extruders, lubricant for plastics and elastomers.

Chemicals - Sealant RTV



Dow Corning 732/GE RTV Multi-Purpose Sealant

Part Number	Sales Unit	Color
065031-001	Net wt 10.3 oz Cartridge	Clear
065031-002	Net wt 3 oz tube	Clear
065031-003	Net wt 3 oz tube	Black

Used for general sealing and bonding. One part nonslumping RTV paste. Tough, rubbery solid. Used on gaskets and terminal blocks.



Loctite 598 High Performance Black RTV Silicone Gasket Maker

Part Number	Sales Unit
323012	Net wt 2.36 oz Tube

Applications (horizontal or vertical): windshields, door frames, electrical connections, seams and roofs, vinyl tops, weatherstripping. General purpose, waterproof, flexible, RTV indoor/outdoor sealant. Seals, bonds, repairs metal, plastics, fabric vinyl. -80°F to 450°F.



Dow Corning RTV Sealant 734 Flowable Sealant

Part Number	Sales Unit
065031-005	Net wt 3 oz Tube

100% silicone rubber. Self-leveling consistency. Forks flexible, long lasting seal. Extreme temperature performance. Applications: Making formed in place gaskets, filling minute cracks and crevices, sealing electrical equipment, sealing threads, coating fabrics and encapsulating small components. Used on heaters in freezer applications.



Dow Corning 748 Non-Corrosive Sealant

Part Number	Sales Unit	Color
065031-004	Net wt 10.3 oz Cartridge	White
065031-007	Net wt 3.3 oz Tube	White

100% silicone rubber, safe for food contact, non-corrosive, -67° F to 350° F. Applications: Sealing corrosion-sensitive electrical & electronic equipment (electrical connections, wire entries, power and control cable connections, etc.), bonding and sealing food processing equipment. Formed-in-place gaskets for sensitive substrates. Used on modules and distribution panels.

⚠️WARNING: Cancer and reproductive harm - www.P65Warnings.ca.gov



Loctite 593 Superflex Black RTV Silicone

Part Number	Sales Unit
323011	Net wt 2.36 oz Tube

Formulated to withstand extreme temperature cycling (-65°F to 450°F), UV light and ozone. Cannot be painted. Tack free in 30 minutes; full strength in 24 hours. General purpose, one-part silicone adhesive sealant. Cures at room temperature to form a tough rubber seal. Will not slump in overhead or vertical applications.

Chemicals - Gasket Sealer



Form-A-Gasket Sealant Liquid

Part Number	Sales Unit
065005-001	Net wt 16 oz Can

Resists hot and cold water, antifreeze, glycerin, fuel oil, kerosene, butane, and other fluids. Pressure resistant and leakproof to high octane gasoline, grease and lubricating oils. Applied as liquid changes to paste in a few seconds.



Loctite Aerosol Hi-Tack Gasket Sealant 30526

Part Number	Sales Unit
363009	Net wt 9 oz Can

Red-colored liquid sealant that holds gaskets in place during assembly. Seals and bonds rubber, cork, paper, felt, metal and asbestos gaskets. Sets quickly to a very tacky film. Suitable to 500°F (260°C). Contains no ozone-depleting compounds. Increased oil resistance. Non-corrosive.



Loctite Hi-Tack Gasket Sealant 30525

Part Number	Sales Unit
065005-002	Net wt 16 oz Can

Red-colored, liquid sealant that holds gaskets in place during assembly. Seals and bonds rubber, cork, paper, felt, metal and asbestos gaskets. Sets quickly to a very tacky film.

Repair Filler



3M Bondo Body Filler

Part Number	Sales Unit
MSC00001834	32 oz Tub

Shapes in minutes; formulated to be non shrinking, non reactive, permanently durable material for repairing metal, wood, steel, and plastic. Repairs dents, patches holes and leaks, and restores chips quickly.

⚠️WARNING: Cancer - www.P65Warnings.ca.gov

Filter Cross Reference



Oil & Transmission Filters
364100-xxx



Fuel Filters
364300-xxx



Hydraulic Filters
364500-xxx



Fuel/Water Separators
364600-xxx



Air Filters
364200-xxx

OE Number	Crown Part Number
AC Delco (AB)	
1240619-H2	364600-004
24-897	364500-016
550C	364200-024
6732-71-6310	364600-004
6733-71-9110	364600-004
A1033C	364200-027
A1169C	364200-045
A120C	364200-049
A133C	364200-049
A1506C	364200-048
A1518C	364200-043
A1519C	364200-043
A1604C	364700-002
A170C	364200-049
A170CW	364200-049
A251C	364200-048
A301CL	364200-046
A3086C	364200-043
A5004	364200-027
A529C	364200-036
A72C	364200-048
AC95	364950-001
C111	364950-001
C14	364950-001
C203	364950-001
C203X	364950-001
C301	364950-001
C315	364950-001
C316	364950-001
CU3931062	364600-004
CUFS1251	364600-004
K14	364950-001
K15	364950-001
L14	364950-001
P203X	364950-001
P204	364950-001
PC133K	364200-046
PF1051	364100-008
PF1056	364100-051
PF1091	364500-009
PF1097	364500-014
PF1127	364100-046
PF1180	364100-037
PF1212	364100-017
PF1218	364100-048
PF1222	364100-008
PF1230	364100-008
PF1233	364100-041
PF1237	364100-065
PF1238	364100-044
PF1250	364100-049
PF13	364100-020
PF17	364100-052
PF20	364100-050
PF2057	364100-015
PF2072	364500-011
PF2112	364100-065

OE Number	Crown Part Number
PF2123	364100-044
PF2132	364100-042
PF2135	364100-065
PF2140	364100-050
PF2174	364100-091
PF2191	364100-050
PF2203	364100-051
PF2210	364100-050
PF28	364100-052
PF33	364100-086
PF41	364100-044
PF46	364100-019
PF48	364100-031
PF59	364100-084
PF881	364500-009
PF897	364500-016
PF9	364100-047
PF926	364500-005
PF933	364100-086
PF952	364100-050
PF960	364100-045
PM13-16	364500-016
T1068	364300-017
TP1001	364300-024
TP1067	364300-027
WF114	364900-001
X116	364100-017
X119	364100-046
X120	364100-008
X124	364100-017
X13	364100-050
X15	364100-044
X18	364100-044
X1K	364100-020
X20	364100-044
X46	364100-008
X7	364100-050
X72	364100-075
X9	364100-044
XD701	364300-013
Allis Chalmers/Tusk (AC)	
0232578	364100-005
0237000	364100-005
0255191	364100-026
0490015	364200-046
0507826	364950-001
0681546	364900-001
0697635	364900-001
1004421	364200-018
10044213	364200-018
1004652	364200-018
10046522	364200-018
10050698	364300-003
10050789	364300-003
1014120	364100-038
1014121	364100-026
1122177	364100-026
1140887	364200-018

OE Number	Crown Part Number
1240483-H1	364300-024
1240621-H1	364500-015
190910-4	364950-001
20701K1230	364300-027
20801K1310	364300-024
20974077	364200-007
21P01K1390	364300-027
21U6-011330	364100-083
240760	364200-007
243163	364200-003
2447281	364200-046
246364	364200-007
246366	364200-007
247060	364200-007
2470607	364200-007
251397	364300-003
2513976	364300-003
252050	364300-003
3100276	364100-035
3193115	364950-001
344622	364200-046
4006995	364300-031
4048147	364950-001
4048417	364950-001
4059263	364100-016
4059343	364100-016
4060050	364300-003
40600504	364300-003
4135600-0	364100-050
4348147	364950-001
43905934	364100-016
4394407	364300-031
4490296	364300-003
4502498	364950-001
4502498-4	364950-001
4502499	364950-001
4502499-4	364950-001
4511629	364100-005
4512207	364100-016
4530702	364100-007
4789026	364200-003
4855745	364100-034
4900600	364100-016
4905902	364100-035
4906397	364100-035
4907794	364200-002
4907795	364200-003
4910328	364100-038
4910775	364100-005
4910810	364100-005
4915223	364100-036
4915238	364200-007
4915347	077145
4940471	364400-004
4941243	364500-003
4941711	364500-004
4942265	364100-001
4942493	364100-001

OE Number	Crown Part Number
4942494	364100-005
4942587	364200-003
4942657	364100-036
4945308	364400-004
4947751	364100-034
4948738	364100-050
4948955	364100-001
4949078	364200-002
4953804	380103-911
4966684	364100-020
4968759	364100-037
4996245	364200-003
4997958	364100-036
4999447	364100-035
507826	364950-001
540955	364950-001
545240	364950-001
600-211-5242	364100-086
600-311-8281	364300-031
600-311-8290	364300-031
600-311-8291	364300-031
600-311-8292	364300-031
6127-71-6090	364300-031
617966M	364950-001
62703506	364100-026
639050	364200-003
6732-71-6110	364300-027
6732-71-6111	364300-027
6732-71-6112	364300-027
67355-15140	364500-015
67365-15140	364500-015
6742-01-3790	364300-027
7020000	364200-002
70240760	364200-007
70243163	364200-003
70246364	364200-007
70246366	364200-007
70247060	364200-007
70639050	364200-003
72470607	364200-007
73100276	364100-035
74059263	364100-016
74059343	364100-016
74512207	364100-016
74530702	364100-007
74789026	364200-003
74855745	364100-034
74900600	364100-016
74905902	364100-035
74906397	364100-035
74907794	364200-002
74907795	364200-003
74915043	364300-003
74915238	364200-007
74915347	077145
74920158	364100-004
74941575	364200-002
74942265	364100-001

▲ WARNING: Cancer - www.P65Warnings.ca.gov

Note: More crosses available; contact your dealer.

1.28 Crown One Source

Allis Chalmers/Tusk Continued ▶

Filter Cross Reference

Allis Chalmers/Tusk Continued

OE Number	Crown Part Number
74942493	364100-001
74942587	364200-003
74943271	364200-002
74947751	364100-034
74947978	364100-007
74948955	364100-001
74949078	364200-002
74996245	364200-003
74996253	364200-002
74999447	364100-035
8760118	364100-041
8761948	364100-014
8763270	364100-037
8765210	364100-030
8767408	364200-014
8775054	364100-015
8775086	364200-026
8775575	364100-015
890321-H1	364200-046
AX58828	364200-046
B4844	364950-001
CU3315843	364300-024
CU3903640	364300-027
CUFF5052	364300-027
DE48147	364950-001
DE65245	364100-016
DHD222	364100-034
DNP13D8627	364300-031
DPF20	364100-037
DPF2072	364500-011
DPF56	364100-038
DPF855	364100-035
DPF881	364500-009
DPF897	364500-016
DPF939	364100-026
DTP1067	364300-027
Baker (BK)	
0001160243	364300-027
0001174423	364300-027
0009830532	364300-029
0009830608	364100-034
0009830608V	364100-034
0009830621	364100-068
0009831415	364100-083
0009831615	364300-001
0009831617	364300-001
0009831625	364300-001
0009831625V	364300-001
0009831631	364200-018
0009831647	364300-001
0009831647V	364300-001
0009839012	364200-027
0009839012V	364200-027
0019831605	364200-064
068127177B	364300-001
101052	077145
101053	364100-007
101254	364100-016
1035337001	364300-003
1036728001	364100-038
104170	364200-003
118740	364100-022
126695	364100-007
135396	364100-022
151418	364300-001
19831605	364200-064
400204	364100-005

OE Number	Crown Part Number
7370	364950-001
737E1	364950-001
737J1	364200-009
737R1	364100-016
737W1	364100-016
9033AY1	364200-002
9033BM1	364200-003
9830606	364100-020
9830608	364100-034
9830621	364100-068
9831625	364300-001
9831631	364200-018
9839012	364200-027
A0102	364100-020
G151310232900	364300-009
L0001160243	364300-027
L0001174423	364300-027
L0009830532	364300-029
L0009830600N	364100-026
L0009830607	364100-045
L0009830621	364100-068
L0009831415	364100-083
L0009831615	364300-001
L0009831617	364300-001
L0009831647	364300-001
L016000002	364100-032
L0312225208N	364100-026
L1160024	364100-032
L1174418	364100-032
L68115561BN	364100-026
L68115561N	364100-026
L7995000510	364100-032
LAE725006049	364100-044
LF9454982	364500-009
LFM8000435	364100-016
LFM8102165	364100-044
LH17W04	364100-032
LPC202	364100-032
LW94018	364100-032
XVW074115562	364100-068
Baldwin (BW)	
B113	364100-001
B114	364100-045
B114B	364100-045
B120	364100-037
B125	364100-028
B132	364100-050
B1400	364100-065
B1402	364100-015
B1405	364100-076
B141	364100-047
B141B	364100-047
B1428	364100-048
B1428B	364100-048
B143	364100-009
B1431	364100-067
B1431B	364100-067
B1432B	364100-084
B159	364100-017
B159B	364100-017
B160	364100-031
B161	364100-008
B161-S	364100-008
B161SB	364100-008
B163	364100-020
B173-S	364100-004
B178	364100-022

OE Number	Crown Part Number
B2	364100-005
B227	364100-046
B227B	364100-046
B228	364100-044
B228B	364100-044
B233	364100-050
B243	364100-039
B247	364100-010
B252	364100-034
B253	364100-034
B27	364100-012
B31	364100-019
B329	364100-049
B33	364100-041
B34	364100-023
B35-S	364100-003
B37	364100-011
B421	364100-002
B421B	364100-002
B43	364100-024
B43-S	364100-024
B50	364100-016
B7039	364100-091
B7042	364100-013
B7049	364100-014
B7125	364100-028
B7144	364100-033
B7144B	364100-033
B7152	364100-081
B7177B	364100-083
B7181	364100-025
B7221	364100-080
B7240	364100-066
B7240B	364100-066
B7243	364100-071
B7290	364100-075
B7306	152128
B7333	364100-069
B7446	364100-043
B7449	364100-097
B75	364100-051
BA5374	364100-088
BF1110	364300-015
BF1110B	364300-015
BF1210	364600-001
BF1212B	364300-024
BF1226B	364600-004
BF1257	364300-005
BF1257B	364300-005
BF1258	364300-004
BF1258B	364300-004
BF1261	364300-013
BF1261B	364300-013
BF1280	364300-017
BF1280B	364300-017
BF1352-SPB	364300-023
BF1352-SPS	364300-023
BF5800	364300-002
BF587	364300-001
BF7534	364600-003
BF7633	364300-007
BF7673	364300-008
BF7673B	364300-008
BF7673D	364300-008
BF7681	364300-032
BF7681-D	364300-032
BF7683	364300-010

OE Number	Crown Part Number
BF7683B	364300-010
BF7760	364300-018
BF7760B	364300-018
BF7863	364300-011
BF788B	364300-027
BF788-PRO	364300-027
BF7932	364300-016
BF7957	364300-014
BF825	364300-003
BF836-K3	364300-034
BF970	364300-031
BF9894	364300-020
BF995B	364300-033
BPH13A	364100-012
BPH8A	364100-005
BT215	364100-038
BT216	364100-026
BT217	364100-064
BT217B	364100-064
BT223	364100-030
BT230B	364500-016
BT237	380103-911
BT259	364100-052
BT259B	364100-052
BT260-10	364100-036
BT274B	364100-086
BT282-10	364100-035
BT287-10	364100-029
BT310	364100-006
BT339B	364500-015
BT344-S	364100-021
BT351	364500-009
BT351B	364500-009
BT364	364100-007
BT389-10	364500-014
BT389-10B	364500-014
BT40034	364100-092
BT420	380030-180
BT427	364100-032
BT7237	364100-078
BT7237-MPG	364100-078
BT7339B	364500-015
BT839-10	077145
BT8409	364400-001
BT8416	364500-026
BT8428-MPF	364100-040
BT8439-MPG	364400-003
BT8449-10	364100-035
BT8449-10B	364100-035
BT8472	364500-008
BT8472B	364500-008
BT8493	364400-002
BT8833	364400-009
BT8840-MPG	364100-018
BT8843-MPG	364100-079
BT9422	364500-013
BW5086	364900-002
BW5086B	364900-002
P40119	364950-002
P7308	364100-068
PA10093	364200-053
PA1636FN	364200-046
PA1667-FN	364200-003
PA1681-FN	364200-018
PA1690-FN	364200-002
PA1822-FN	364200-036
PA1822-FNB	364200-036

Baldwin Continued ▶

⚠ WARNING: Cancer - www.P65Warnings.ca.gov

Note: More crosses available; contact your dealer.

Filter Cross Reference

Baldwin Continued

OE Number	Crown Part Number
PA1865-FN	364200-007
PA2221	364200-004
PA2360-FN	364200-024
PA2450	364200-001
PA2570	364200-064
PA2575	364200-006
PA2576	364200-016
PA2725	364200-022
PA2778-FN	364200-001
PA2949-FN	364200-025
PA3608-FN	364200-020
PA3612	364200-027
PA3651-FN	364200-028
PA3792	364200-037
PA3792B	364200-037
PA3805-FN	364200-005
PA3833	364200-011
PA3989-FN	364200-041
PA3989-FNB	364200-041
PA4102	364700-002
PA4113B	364200-043
PA4390	364700-005
PA5582	364250-001
PA5583	364200-032
PA640	364200-009
PA649	364200-049
PA678	364200-048
PF717	364300-009
PF717B	364300-009
PT381	364500-011
PT716	380030-128
PT752	364500-018
PT83	364500-005
PT83B	364500-005
PT8515-MPGKIT	364400-008
PT8515-MPGKITB	364400-008
PT9167	364500-007
PT9415-MPG KIT	364400-008
PT9448	380030-114
RS2863B	364200-045
RS3528	364200-013
RS3529	364200-017
RS3542	364200-039
RS3543	380030-009
RS3544	364200-026
RS3544B	364200-026
RS3545	364200-031
RS3549	364200-010
RS3703	364200-015
RS3703B	364200-015
RS3704	142110
RS3704B	142110
RS3705	364200-042
RS3715	364200-047
RS3716	364200-014
RS3744	364250-003
RS3745	364250-004
RS3747	364200-023
RS3920	364200-040
RS3920B	364200-040
RS3940	364200-008
RS3940B	364200-008
RS3988B	364200-050
RS4131	364200-019
RS5745	364250-002
RS5517	364200-051

OE Number	Crown Part Number
Bosch (BQ)	
1-457-429-155	364950-001
1-457-429-156	364950-001
1-457-429-170	364950-001
1-457-429-172	364950-001
1-457-429-191	364950-001
1-457-429-240	364950-001
1-457-429-241	364950-001
1-457-429-619	364100-068
1-457-429-838	364200-027
1-457-429-951	364200-046
1-457-429-951-850	364200-046
1-457-431-225	364950-001
1-457-431-477	364950-001
1-457-431-478	364950-001
1-457-431-483	364950-001
1-457-434-103	364300-013
1-457-434-116	364300-013
1-457-434-118	364300-013
1-487-434-001	364100-088
1-487-434-005	364100-088
1-986-452-003	364100-020
1-986-452-006	364100-008
1-987-430-026	364200-046
26A	364200-046
3312	364100-008
4087HE	364950-001
4128HE	364950-001
451-001-001	364100-050
451-001-002	364100-050
451-001-002-850	364100-050
451-001-053	364100-050
451-001-053-850	364100-050
451-001-150	364100-050
451-102-001	364100-044
451-102-002	364100-020
451-102-056	364100-044
451-102-901	364100-044
451-103-003	364100-020
451-103-011	364100-050
451-103-011-310	364100-020
451-103-012	364100-020
451-103-014	364100-020
451-103-018	364100-050
451-103-018-850	364100-050
451-103-019	364100-044
451-103-021	364100-044
451-103-022	364100-050
451-103-025	364100-020
451-103-026	364100-044
451-103-027	364100-075
451-103-029	364100-050
451-103-034	364100-075
451-103-035	364100-075
451-103-036	364100-075
451-103-040	364100-050
451-103-041	364100-050
451-103-041-850	364100-050
451-103-043	364100-044
451-103-044	364100-050
451-103-048	364100-075
451-103-049	364100-044
451-103-050	364100-044
451-103-073	364100-075
451-103-080	364100-075
451-103-084	364100-044
451-103-096	364100-044

OE Number	Crown Part Number
451-103-127	364100-044
451-103-133	364100-050
451-103-136	364100-050
451-103-141	364100-050
451-103-142	364100-020
451-103-166	364100-050
451-103-167	364100-050
451-103-171	364100-020
451-103-901	364100-044
451-103-902	364100-020
451-103-903	364100-050
451-104-005-850	364100-052
451-104-065	364100-045
451-163-019	364100-075
451-203-003	364100-050
451-203-009	364100-026
451-203-009-850	364100-026
451-203-010	364100-064
451-203-012	364100-045
451-203-061	364100-045
451-203-088	364100-045
451-203-154	364100-020
451-203-194	364100-026
72101	364100-020
72103	364100-020
72177	364100-017
8244H	364100-008
9-450-732-002	364100-020
9-450-732-005	364100-020
9-450-732-006	364100-050
9-450-732-010	364100-044
9-451-160-026	364200-046
9-457-240-870	364950-001
9-457-280-14050	364100-052
9-457-281-270	364100-050
9-457-282-170	364100-020
9-457-282-190	364100-075
9-457-282-440	364100-008
986-452-003	364100-050
986-452-006	364100-008
986-452-007	364100-046
986-452-008	364100-047
986-452-019	364100-075
986-452-028	364100-041
986-452-903	364100-020
986-452-917	364100-041
986-452-928	364100-041
FJSJ24S3Z	364950-001
O004	364100-041
O133	364100-044
O213	364100-044
O219	364100-050
O222	364100-050
O231	364100-050
O314	364100-020
O317	364100-041
O414	364950-001
O626	364100-045
OF124	364100-045
OF152	364100-045
OF160	364100-045
OF162	364100-050
P1150	364100-050
P2003	364100-050
P2006	364100-008
P2007	364100-046
P2008	364100-047

OE Number	Crown Part Number
P2028	364100-041
P2056	364100-044
P3010	364100-064
P3012	364100-045
P3029	364100-050
P3050	364100-044
P3084	364100-044
P3136	364100-050
P3141	364100-050
P3142	364100-020
P3154	364100-020
P3166	364100-050
P3167	364100-050
P3171	364100-020
P3194	364100-026
P4065	364100-045
P9170	364950-001
P9191	364950-001
P9241	364950-001
S9838	364200-027
Caterpillar/Towmotor (CT)	
0068147	364100-016
0068940	364200-003
0313658	364100-005
0314361	364100-005
0329060	364100-026
0342449	364100-029
0349804	364500-011
0363992	364500-009
0643736	364950-001
0663384	364200-018
0665459	364200-018
0665934	077145
0668373	364200-018
0684163	364200-018
0687743	364200-046
0689401	364200-003
0694229	364100-026
0902900	364100-018
0938717	364200-018
0971215	364100-034
0971426	364200-007
0971427	364100-004
0971434	364100-006
0971451	364100-007
0971489	364100-038
0972415	364100-035
0972629	364100-034
0972961	364200-001
0973352	380103-911
0973412	364200-001
0973440	364100-006
0973608	364100-006
0973976	364100-003
0973999	364200-004
1014755	364100-002
1015177	364400-007
1015412	364200-028
1015623	364500-003
1032901	364300-015
1033496	364200-018
1033660	364500-010
1036887	074105
1037452	364400-007
1037819	364100-002
1038604	364100-004
1039208	364100-007

⚠ WARNING: Cancer - www.P65Warnings.ca.gov

Note: More crosses available; contact your dealer.

Caterpillar/Towmotor Continued ▶

Filter Cross Reference

Caterpillar/Towmotor Continued

OE Number	Crown Part Number
1039649	364200-011
1039880	364100-015
1041296	364600-003
1041340	364100-015
1041426	364100-002
1041427	364100-015
1049852	077145
1049853	077145
1085330	364200-011
1106326	364200-026
1146853	364100-033
1146934	364100-006
1148105	364200-046
1157207	364400-007
1177394	077145
1194740	364500-012
1213661	142110
1232367	364200-039
1348726	364200-050
1383100	364300-032
1402334	364200-015
14049960	364200-027
1421339	364250-003
14483050	364500-010
1467172	142110
1467472	142110
1634465	364300-032
1767710	364100-075
1A3479	364300-031
1N3224	364500-016
1N4402	364100-013
1N4402H	364100-013
1P2299	364300-031
1R0711	364300-031
1R0713	364500-016
1R0714	364100-051
1R0734	364100-007
1R0740	364300-031
1R711	364300-031
1R713	364500-016
1R734	364100-007
1W2638	364500-016
1W8633	364300-031
216434	364200-024
226-6561	364300-024
226-6567	364900-001
231-0167	364200-039
231-0168	380030-009
26910875	364400-006
213007	364100-015
215044	364200-003
215120	077145
215488	364100-036
215999	364200-027
216318	364100-035
216434	364200-024
217724	364200-049
218660	364100-041
2W4246	364200-022
3003076800	364200-046
3003076801	364200-046
302877	364100-038
3063056800	364200-002
30A4000100	364100-015
30A4000101	364100-015
30A4000102	364100-015
30A4000103	364100-015

OE Number	Crown Part Number
30A4000105	364100-015
30H3003710	364200-050
30H30-03710	364200-050
3113002300	364200-046
313658	364100-005
314361	364100-005
329060	364100-026
32B40-00100	364100-033
32B40-10100	364100-033
32C40-00100	364100-006
3358	364300-027
342449	364100-029
34462-00300	364300-015
34462-11040	364600-003
34462-21040	364600-003
34730-04500	364200-046
349804	364500-011
349970	364100-029
361745	364300-003
363992	364500-009
364464	364100-005
371682	364100-038
386926	364100-021
3C2877	364100-038
3G6337	364500-012
3G6925	364500-012
3G6928	364100-021
3I0266	364200-064
3I0396	364200-018
3I0601	364500-005
3I0721	364500-016
3I0743	364200-026
3I0806	364200-018
3I0932	364200-018
3I1080	364300-001
3I1089	364100-052
3I1114	364100-003
3I1136	364100-050
3I1156	364950-001
3I1178	364300-017
3I1179	364300-027
3I1214	364100-020
3I1261	364100-050
3I1290	364900-001
3I1296	364100-026
3I1305	364300-024
3I1312	364300-024
3I1327	364500-016
3I1337	364100-051
3I1365	364300-024
3I1367	364300-024
3I1438	364500-005
3I1479	364100-065
3I1490	364100-020
3I1550	364200-045
3I1571	364200-048
3I1597	364500-009
3I1603	364100-006
3I1627	364100-050
3I1663	364500-014
3I2013	364200-045
3I2109	364100-049
3I2132	364300-017
3I2147	142110
3R0711	364300-031
4T6788	364100-029
4T7948	364500-012

OE Number	Crown Part Number
50020152	364500-009
50021437	364200-039
50021439	380030-009
50237043	364200-040
50111722	364400-006
51209	364500-012
52034015	364200-050
566B1405	364100-076
566B7177	364100-083
566B7290	364100-075
566BD7176	364100-074
566BF1212	364300-024
566BF1280	364300-017
566BF7681D	364300-032
566BF7760	364300-018
566BF788	364300-027
566BF970	364300-031
566BF995	364300-033
566BT38910	364500-014
566BT7237MPG	364100-078
566BT8416	364500-026
566BT8417	364500-012
566BT8454	364500-013
566BT8833	364400-009
566BW5073	364900-001
566BW5086	364900-002
566PA2570	364200-064
566PA678	364200-048
566PT752	364500-018
566RS3705	364200-042
566RS3744	364250-003
566RS3745	364250-004
5882210072	364400-007
5A6717	364300-031
5C1791	364100-005
636082	364950-001
643736	364950-001
64375-91800	364100-004
65625-05300	364100-006
665459	364200-018
665934	077145
673217	364200-046
676987	364300-003
68147	364100-016
68148	364100-016
682994	364200-046
687743	364200-046
687744	364200-018
68940	364200-003
689401	364200-003
694229	364100-026
6A5162	364200-027
6A5162V	364200-027
6E0924	364500-012
6E0925	364500-012
6-E-924	364500-012
6E924	364500-012
6G924	364500-012
6I1450	364200-013
6-I-1451	364200-017
6I1451	364200-017
6L7440	364300-031
6-N-1009	077145
6N1009	077145
6N3784	364300-031
6V5875	364500-016
77-8190	364500-016

OE Number	Crown Part Number
7N9027	364200-016
7N9028	364200-006
7W2326	380103-911
7W2327	364100-026
7W2328	364100-038
7W2692	364200-006
7W6221	364100-026
817003	364100-075
8J1600	364100-029
8L9765	364300-031
8N5504	364200-006
8N5504E	364200-006
8N5540	364200-006
8N9586	364500-016
8T7427	364500-016
902900	364100-018
9042000460	364100-003
9042501750	364100-002
9042508220	364300-006
9122000500	364100-004
9122010500	364100-004
9122407100	364400-007
9122407101	364400-007
9126100040	364200-028
9126100041	364200-028
9126100700	364200-002
9126106700	364200-028
9127503300	364500-003
9127503301	364500-003
9127513000	364500-003
9127513300	364500-003
9127513301	364500-003
9127605100	364100-004
9136100900	364200-011
9136100901	364200-011
9136103300	364200-011
9136110900	364200-011
9136113300	364200-011
9137503800	380030-114
9186101600	364200-041
9186105600	364200-018
9187501400	364500-010
9187505900	364500-010
9187511400	364500-010
91A6500611	364300-006
91B6100112	142110
91B6100912	364200-014
91E6100112	364200-010
91H2001870	364100-014
91K6101700	380030-009
91K6102112	380030-123
91K6102300	380030-009
93A2405500	380102-334
971215	364100-034
971216	364200-009
971217	364200-002
971251	364100-001
971289	364100-020
971309	364100-020
971357	364300-003
971426	364200-007
971427	364100-004
971434	364100-006
971441	364100-012
971451	364100-007
971489	364100-038
971630	364100-023

WARNING: Cancer - www.P65Warnings.ca.gov

Note: More crosses available; contact your dealer.

Caterpillar/Towmotor Continued ▶

Filter Cross Reference

Caterpillar/Towmotor Continued

SERVICE SUPPLIES

OE Number	Crown Part Number
972415	364100-035
972422	364100-020
972545	364100-020
972597	364100-005
972629	364100-034
972703	364100-001
972961	364200-001
973356	364100-022
973412	364200-001
973440	364100-006
973608	364100-006
973976	364100-003
973999	364200-004
9G6926	364500-012
9I2646	364100-006
9L9054	364100-007
9L9200	364100-007
9N3717	364900-001
9N5570	364500-016
9-N-5570	364500-016
9N5680	364100-007
9N9586	364500-016
9T5664	364100-029
9Y0858	364100-051
9Y4431	364300-024
9Y4432	364300-024
9Y4450	364100-052
9Y4455	364100-003
9Y4464	364100-089
9Y4479	364100-026
9Y4480	364100-038
9Y4487	364100-020
9Y4492	364100-044
9Y4494	364100-006
9Y4499	364950-001
9Y4506	364100-050
9Y4507	364100-006
9Y4523	364500-005
9Y4532	364900-001
gY6823	36200-064
9Y6838	364200-046
9Y6841	364200-018
9Y858	364100-051
A00000063	364200-010
A000000313	364100-016
A000001339	364100-079
A000002445	364500-002
A000002806	364200-008
A000003164	364100-015
A000003273	364200-011
A000003458	142110
A000005479	364100-011
A000009231	364500-010
A000009241	364500-015
A000010905	364200-026
A000013911	364300-002
A000014210	364100-091
A000014472	364950-001
A000014514	364100-084
A000014529	364200-043
A000015358	364200-045
A000015983	364200-050
A000015985	364300-009
A000015986	364200-047
A000016007	364300-017
A000016048	364300-024
A000016115	364300-023

OE Number	Crown Part Number
A000019497	364200-050
A000026444	380030-162
A000026485	364400-006
A000026486	364500-015
A000026490	364400-006
A000026588	380030-162
A000026778	364300-032
A000027284	364100-078
A000029035	364200-048
A000029038	364200-047
A000029315	364100-083
A000031488	364250-004
A000031589	364500-012
A000031655	364100-089
A000036418	364500-015
A000037496	364250-002
A218649	364100-012
A218869	364200-029
A218870	364200-030
A643736	364950-001
D180237	364200-006
D490060	364200-029
D490416	364200-030
D501564	364500-002
E38874	364100-020
FW17	364900-001
FW9AFP	364900-001
GE924	364500-012
LE3ADG6926	364500-012
LM40DQ9804	364500-011
LM4ODQ9804	364500-011
MCF00321	364100-021
MD001445	364100-047
MD001450	364100-004
MD005445	364100-004
MD005450	364100-004
MD007095	364100-004
MD007360	364100-004
MD013661	364100-013
MD01445	364100-047
MD017410	364100-004
MD030795	364100-004
MD031805	364100-004
MD041462	364100-004
MD071462	364100-006
MD071462/A	364100-004
MD084693	364100-015
MD135707	364100-015
MD135737	364100-015
MD136466	364100-002
MD136780	364100-015
MD136790	364100-046
MD162326	364100-006
MD322508	364100-015
MD325714	364100-015
MD332687	364100-002
MD352626	364100-002
MD360935	364100-015
ME013661	364100-013
ME033617	364200-046
ME060219	364200-046
MM200570	364200-007
MM220900	364600-003
MM310860	364100-004
MM315200	364100-004
MM404981	364200-007
MM433093	364300-009

OE Number	Crown Part Number
MO031805	364100-015
NA087002	074105
TM225L217	364950-001
Champ/Luberfiner (CH)	
HP1	364100-034
L296F	364300-003
LAF1275	364200-002
LAF1732	364200-027
LAF1820	364200-006
LAF222	364200-003
LAF234HD	364200-046
LAF2745A	364200-007
LAF4246	364200-022
LAF4544	364200-026
LAF5042	364200-020
LAF8157	364200-025
LAF8630	364200-001
LFF3417	364300-017
LFF3504	364300-001
LFF3521	364300-027
LFH4268	364500-009
LFP2215	364100-020
LFP3	364950-001
LFP780	364500-015
LS165	364100-075
LS99	364100-075
P3	364950-001
PH16	364100-050
PH227K	364100-001
PH228	364100-020
PH2808	364100-002
PH2830	364100-037
PH2835	364100-030
PH2841	364100-011
PH8862	364100-075
Chrysler (CY)	
1711791	364950-001
1711971	364950-001
3549957	364100-050
3685741	364100-050
3838011	364100-047
4026486	364100-047
4186165	364100-047
4417559	364100-050
4417560	364100-050
4419970	364100-080
44199700	364100-050
4429395	364500-015
4746914	364500-015
4761277	364500-015
5281090	364100-023
75221481	364100-050
83501080	364100-050
HA302494	364950-001
HA302495	364950-001
HA302496	364950-001
J0647345	364950-001
J0909335	364950-001
J8990041	364950-001
J8990068	364950-001
L1008	364100-050
L19	364100-050
L19V	364100-050
L19X	364100-050
L31750	364100-052
L319	364100-020
L530	364100-020

OE Number	Crown Part Number
L6	364950-001
MD017440	364100-046
MD136790	364100-046
T0730077	364100-047
T1365661	364100-020
X3549957	364100-050
Clark (CL)	
1232560	364300-009
1238466	364500-013
1243309	380030-180
1375550	364400-002
1582766	364300-031
15H999	364950-001
161WA258	364200-018
161WA357	364200-018
1624567	364200-018
1632441	364200-046
1670331	364200-007
176626	364950-001
1800976	364100-016
1801141	364100-034
1803991	364200-003
1803993	364200-002
1803995	364200-001
1804012	364200-016
1804038	077145
1804039	364100-029
1804041	364100-035
1804042	364100-013
1804045	364100-006
1804048	364100-016
1804051	364950-001
1804053	364100-034
1804054	364100-020
1804059	364100-050
1804065	364100-009
1804067	364100-006
1804073	364100-020
1804075	364100-021
1804081	364100-037
1804082	364100-013
1804083	364100-017
1804084	364100-001
1804085	364100-008
1804087	364100-003
1804088	364100-006
1804090	364100-044
1804107	077145
1804109	364200-020
1804110	364200-003
1804122	364300-015
1804129	364500-011
1804130	364500-009
1804133	364200-013
1804134	364200-017
1804139	364100-006
1804160	364400-004
1804169	364200-011
1804170	364100-014
1804185	364100-012
1804193	380030-164
1804194	364100-041
1804199	364100-035
1804200	364600-003
1804201	364200-002
1804223	364200-027
1804225	364200-003

▲ WARNING: Cancer - www.P65Warnings.ca.gov

Note: More crosses available; contact your dealer.

Clark Continued ▶

Filter Cross Reference

Clark Continued

OE Number	Crown Part Number
1804290	364300-027
1804420	364100-032
1804424	364500-015
1805375	142110
1810884	364100-026
1810935	364100-038
1815007	364200-003
1815143	364100-076
1820450	364200-046
1902215	364200-018
1917097	364100-018
1992366	364300-017
218869	364200-029
218870	364200-030
220070365	364500-011
2353816	364200-002
2373789	364200-004
2393449	364200-024
2399992	364200-004
244195	364100-079
247050	380030-046
2526831	364500-018
26561118	364300-001
2786616	364100-018
2791707	364200-010
2792962	364100-079
2817055	364100-062
2P0661	364100-016
3000063	364500-012
3000084	364500-011
3006350	364500-012
3040205	364500-011
3042173	364200-010
3042258	364500-012
3043684	364600-003
3127098	364950-001
3140102	364500-012
3143748	364500-012
3291008	364300-003
3338969	364300-003
3339643	364100-026
3340165	364100-037
3493878	364200-002
3575976	364900-001
3580376	364200-007
3653017	364500-009
3664917	364300-024
3734465	364100-038
3734468	364100-038
3736405	364100-044
3736833	364100-020
3777841	364100-026
3779228	364300-003
3779685	364100-007
3918206	364100-001
3974113	364100-006
3974113-B	364100-046
3974896B	364100-050
3981922	364300-003
411975	364100-032
4127481	364100-032
4203691	364100-018
4307873	364600-003
4317841	364500-009
4318784	364500-009
4335192	364100-015
4352191	364100-022

OE Number	Crown Part Number
4358425	364300-032
4367855	364100-008
448055	364400-007
448215	364500-010
449934	364400-006
563942	364200-046
604080	364950-001
604081	364950-001
6511766	364100-026
6515541	077145
6516722	077145
6518241	364200-048
6552449	364100-029
6591038	364100-029
6598361	364200-003
6599543	364100-018
6632745	364100-004
6644015	364100-047
6644210	364100-047
6647773	364300-005
6653968	364300-009
6661248	364100-018
6666333	364200-050
6666334	364200-015
6666376	380030-009
6667352	364300-005
6669547	142110
6673752	364200-047
6676705	364200-015
6681475	364200-064
6686926	364500-026
668788	364200-009
7000484	364200-028
7004639	364100-075
7024278	364900-001
739411010	364600-003
783407	364200-009
800038169	364900-001
8021179	364200-029
8021590	380030-009
8027765	364100-002
8048681	364100-078
852439	364950-001
854571	364950-001
870299	364500-009
880041	364950-001
886525	364200-003
889098	364200-002
892842	364100-036
897064	364200-007
900010	364900-001
904318	364300-009
907211	364300-003
907823	364100-005
909213	364100-004
910207	364100-020
910535	364100-026
910758	364100-052
910780	364100-073
913554	364500-015
913556	364300-017
913557	364300-027
918250	364100-015
918648	364100-002
920665	364600-003
922138	364100-003
923801	364200-010

OE Number	Crown Part Number
924426	364950-001
925682	364500-003
925952	364100-002
926293	364100-015
928371	364300-032
928543	364100-003
928818	364500-015
928825	364300-017
928826	364300-027
930770	364100-015
931800	364100-006
932675	364100-002
932826	364100-058
942426	364950-001
944954	364200-046
948418	364900-001
949095	364300-031
949418	364900-001
949844	364300-003
960044	364900-001
960698	380103-911
960978	364900-001
961673	364900-001
978418	364900-001
990936	364100-016
990937	364100-005
992221	364100-034
994579	077145
995390	364100-080
997239	364200-003
997393	364100-029
A10939	364950-001
AF4066	364200-027
AF843	364200-048
CK2792962	364100-079
DW65125035011	364300-024
FAC1000350	364500-003
FF5047	364600-004
FF5052	364300-027
FS1212	364300-024
FS1251	364600-004
FS1280	364300-017
HCF11054	364200-018
HCF11590	364200-018
HCF14205	364200-018
HCF15919	364200-018
HF6107	364100-034
HF6149	364500-011
HF6160	364100-035
HF6177	364500-009
HF6351	364100-034
HF7933	364100-035
LF3310	364100-044
LF3328	364100-051
LF3342	364500-016
LF3349	364500-015
LF3536	364100-008
LF3537	364100-008
LF3552	364500-015
LF3593	364100-051
LF3653	364100-032
LF4014	364100-044
LF4056	364100-032
LF701	364100-026
MD135753	364100-015
Daewoo (DW)	
0750-131-061	364500-013

OE Number	Crown Part Number
130-3539	364900-001
141106	364200-017
141107	364200-013
213624	364200-015
247052	364400-009
2474-9060	364300-024
3446221040	364600-003
400508-00064	364100-093
4720292	364200-013
474-00026	364200-047
5055105009	364500-015
5125035011	364300-024
65.12503-5011	364300-024
65.05510-5009	364100-025
65.05510-5015	364100-025
65.05510-5021	364100-025
65.12501-7028B	364600-003
65.12503-5011	364300-024
65.12503-5016	364300-004
65.12515-5006	364300-015
65.12515-5008	364600-003
65.21501-7028B	364600-003
7W2327	364100-026
9912-15115	364900-001
A000037496	364250-002
A138746	364500-013
A213624	364200-015
A213625	364200-010
A213938	A213938
A213939	A213939
A218226	364100-065
A218649	364100-012
A218869	364200-029
A218870	364200-030
A232028	364100-003
A251025	364100-026
A273017	364400-004
A273757	364100-025
A273813	364600-003
A293020	364600-003
D140182	D140182
D141100	364100-013
D141106	364200-017
D141107	364200-013
D141121	364200-017
D160552A	364100-026
D161308	364300-001
D164821	364500-011
D180237	364200-006
D180238	364200-016
D470244	364200-015
D470245	364200-010
D490060	364200-029
D490416	364200-030
D501564	364500-002
EAF5067	364200-045
G042544	364200-047
G110119	364200-045
K1019575	364400-001
P131394	364200-064
P169078	364500-026
P164266	364500-018
P171533	364500-019
P173738	364100-079
P181045	364200-046
P527484	364200-045
P528231	364200-048

Daewoo Continued ▶

⚠ WARNING: Cancer - www.P65Warnings.ca.gov
 Note: More crosses available; contact your dealer.

Filter Cross Reference

Deawoo Continued

SERVICE SUPPLIES

OE Number	Crown Part Number
P548963	364200-043
P550371	364100-091
P550399	364300-032
P550434	364300-032
P550440	364300-027
P550505	364100-084
P550520	364100-078
P550660	364300-023
P551329	364300-017
P551429	364300-032
P552126	364900-002
P552203	364300-018
P555010	364300-024
P555570	364500-016
P557440	364300-031
P558000	364300-024
P560971	364400-008
P822686	364200-047
Donaldson (DN)	
21915-99003	364900-001
21915-990032	364900-001
A052526	364200-002
A065007	364200-003
A100017	364200-046
AO80031	364200-018
CFP554073	364900-001
DU770CT	364200-018
DU770T	364200-018
DU8792	364200-046
EAF5067	364200-045
ELF7680	364100-007
EPG110119	364200-045
EPG110120	364200-045
EPG110346	364200-045
FFP170212	364300-024
FFP170915	364300-002
FFP550439	364300-017
FFP550440	364300-027
FFP555001	364300-024
FFP555010	364300-024
FFP558000	364300-024
FFP558020	364300-024
FHG080147	364200-036
FHG080193	364200-018
FHG080286	364200-018
FHG080297	364200-018
FHG080318	364200-018
FHG080491	364200-036
FL915-99003	364900-001
FPG042544	364200-047
FPG042546	364200-047
FPG042575	364200-047
FPG057511	142110
FPG057512	142110
FPG057513	142110
FPG057514	142110
FPG065011	364200-015
FPG065411	364200-015
FPG065424	364200-015
FPG065432	364200-015
FPG065433	364200-015
FPG065459	364200-015
FPG065530	364200-015
FPG070006	364200-039
FPG070009	364200-039
FPG070017	364200-039
FPG070018	364200-039

OE Number	Crown Part Number
FPG070019	364200-039
FPG070020	364200-039
FPG070059	364200-039
FPG070060	364200-039
FW9B	364900-001
FWA060062	364200-018
FWA080022	364200-018
FWA080027	364200-018
FWA080031	364200-018
FWA080046	364200-018
FWA100002	364200-046
FWA100012	364200-046
FWA100021	364200-046
FWA100045	364200-046
FWA100049	364200-046
FWA100051	364200-046
FWA100064	364200-046
FWA100065	364200-046
FWF080061	364200-018
FWG080013	364200-018
FWG080023	364200-018
FWG080026	364200-018
FWG080028	364200-018
FWG080038	364200-018
FWG080044	364200-036
FWG080045	364200-018
FWG080057	364200-018
FWG080070	364200-018
FWG080073	364200-018
FWG080074	364200-018
FWG080085	364200-018
FWG080089	364200-018
FWG080097	364200-018
FWG080117	364200-018
FWG080119	364200-018
FWG080124	364200-018
FWG080141	364200-018
FWG080146	364200-018
FWG080196	364200-018
FWG080380	364200-018
FWG100000	364200-046
FWG100003	364200-046
FWG100007	364200-046
FWG100011	364200-046
FWG100017	364200-046
FWG100018	364200-046
FWG100038	364200-046
FWG100054	364200-046
FWG100056	364200-046
FWG100059	364200-046
FWG100072	364200-046
FWG100086	364200-046
G042544	364200-047
G042575	364200-047
G057511	142110
G057512	142110
G057513	142110
G057514	142110
G065424	364200-015
G065432	364200-015
G065433	364200-015
G070006	364200-039
G070009	364200-039
G070017	364200-039
G070018	364200-039
G070019	364200-039
G070020	364200-039

OE Number	Crown Part Number
G070059	364200-039
G070060	364200-039
G070125	364200-039
G110119	364200-045
G110120	364200-045
G110342	364200-045
G110346	364200-045
HFP552297	364100-086
KAX000512	364200-018
KAX002049	364200-018
KAX002371	364200-046
KAX002401	364200-046
KAX002420	364200-018
KAX002662	364200-018
LFP170007	364100-051
LFP170008	364100-005
LFP170025	364100-012
LFP170050	364100-016
LFP170570	364500-016
LFP550020	364100-052
LFP550047	364100-024
LFP550051	364100-003
LFP550173	364100-004
LFP550203	364950-001
LFP550227	364100-001
LFP552518	364100-050
LFP554403	364100-026
LFP555570	364500-016
LFP556007	364100-051
P101146	364200-018
P101271	364200-018
P105368	364200-036
P107435	364200-018
P107668	364200-036
P107868	364200-036
P108160	364200-018
P112329	364200-018
P115155	364200-018
P118652	364200-036
P124154	364200-018
P124173	364200-036
P124178	364200-018
P126040	364200-018
P131394	364200-064
P131396	364200-064
P132976	364200-018
P133653	364200-018
P134468	364200-006
P151145	364200-036
P154632	364200-036
P162017	364500-005
P162591	364500-018
P163067	364100-035
P164266	364500-018
P164375	364100-018
P164376	364100-018
P165243	364100-035
P166508	364500-016
P168011	364100-024
P168090	364100-026
P168365	364100-051
P169078	364500-026
P170212	364300-024
P170841	364300-034
P171533	364500-019
P171534	364500-007
P171606	364500-008

OE Number	Crown Part Number
P172527	364100-023
P172539	364100-022
P172540	364100-022
P172553	364100-024
P172654	364300-017
P172655	364300-027
P172900	364500-014
P172931	364900-001
P172932	364900-001
P172933	364900-001
P173738	364100-079
P174478	364100-079
P181045	364200-046
P181054	364200-018
P181060	364200-024
P181062	364200-024
P183215	364200-018
P184196	364200-018
P185067	364200-045
P502007	364100-015
P502015	364100-041
P502019	364100-041
P502022	364100-044
P502049	364100-046
P502051	364100-008
P502062	364100-065
P502067	364100-065
P502069	364100-014
P502071	364100-046
P502080	364100-033
P502143	364300-015
P502161	364300-009
P502504	364300-025
P522606	364200-045
P525237	364200-064
P526873	364200-009
P527484	364200-045
P528231	364200-048
P529493	364200-045
P530300	364200-045
P532410	364200-010
P533109	364200-013
P533110	364200-017
P534885	364200-023
P535337	364200-005
P537377	364200-004
P537876	364250-003
P537877	364250-004
P539464	364200-049
P539507	364200-015
P542711	380030-009
P544098	364200-019
P546641	364200-011
P548963	364200-043
P550003	364300-034
P550020	364100-052
P550047	364100-024
P550072	364100-023
P550083	364100-065
P550095	364100-020
P550111	364950-001
P550016	364300-033
P550148	364500-009
P550162	364100-046
P550208	364100-050
P550222	364100-034
P550243	364100-051

⚠ WARNING: Cancer - www.P65Warnings.ca.gov

Note: More crosses available; contact your dealer.

Donaldson Continued ▶

Filter Cross Reference

Donaldson Continued

OE Number	Crown Part Number
P550248	364600-004
P550335	364100-030
P550351	364300-008
P550371	364100-091
P550390	364600-003
P550399	364300-032
P550422	364100-033
P550434	364300-032
P550438	364300-017
P550439	364300-017
P550440	364300-027
P550486	364500-012
P550505	364100-084
P550520	364100-078
P550660	364300-023
P550690	364300-005
P550726	364100-046
P550771	364300-032
P550882	364100-020
P550929	364300-023
P550939	364100-081
P550963	364100-023
P550964	364100-048
P550965	364100-049
P551001	364300-004
P551019	364100-083
P551176	364300-017
P551215	364500-011
P551241	364500-014
P551251	364100-050
P551268	364100-081
P551307	364100-019
P551313	364300-007
P551324	364100-021
P551327	364100-034
P551329	364300-017
P551352	364100-028
P551740	364300-007
P552060	364900-001
P552073	364900-001
P552126	364900-002
P552203	364300-018
P552224	364100-074
P552297	364100-086
P552518	364100-050
P552849	364100-008
P554073	364900-001
P554403	364100-026
P554408	364100-038
P554685	364900-001
P554770	364100-039
P555010	364300-024
P555461	364500-005
P555570	364500-016
P555961	364500-005
P556005	364100-036
P556007	364100-051
P556245	364300-003
P557440	364300-031
P557780	364100-045
P558000	364300-024
P558615	364500-015
P558616	364100-032
P560971	364400-008
P600501	364200-019
P601196	364200-064
P606948	364200-025

OE Number	Crown Part Number
P606953	364200-037
P610903	364200-008
P610905	364200-008
P611859	364200-032
P628326	365250-002
P762591	364500-018
P770123	364200-018
P770372	364200-018
P770589	364200-026
P771538	364200-018
P771543	364200-018
P772579	364200-039
P775300	380030-009
P775749	364200-001
P776730	364200-020
P777279	364250-003
P777409	364250-003
P777414	364250-004
P777654	364200-008
P778404	364200-027
P779146	364100-052
P779148	364100-086
P779150	364100-050
P779152	364100-026
P779164	364100-008
P779180	364100-024
P779184	364100-022
P779191	364100-019
P779193	364100-047
P779197	364100-020
P779208	364100-051
P779215	364100-044
P779217	364100-023
P779218	364500-016
P779219	364100-044
P779523	364500-014
P779600	364500-014
P779612	364500-011
P779662	364100-086
P779671	364100-037
P779961	364100-009
P781466	364100-088
P812432	364200-047
P812440	364200-047
P812537	142110
P812543	142110
P812588	364200-014
P821575	142110
P822686	364200-047
P822768	364200-050
P822769	364200-015
P827653	364200-039
P827654	364200-008
P827655	364200-008
P828889	364200-026
P829332	380030-009
P829333	364200-031
P829964	364200-008
P831424	364200-014
PA640	364200-009
SBG1000343	364200-018
SMP771538	364200-018
SMP771543	364200-018
WA923	364900-001
WA923-5	364900-001
WA956	364900-001
WA9561	364900-001

OE Number	Crown Part Number
Doosan (DOS)	
141106	364200-017
65.12503-5016	364300-004
65.12515-5008	364600-003
A213625	364200-010
A213938	A213938
D141106	364200-017
D141121	364200-017
D501564	364500-002
K1019575	364400-001
Fleetguard (FG)	
0009863	364900-001
3300391S	364300-002
70501	364900-001
AA2922	364200-036
AF1606K	364200-024
AF1658	364200-007
AF1759	364700-001
AF1891	364200-016
AF1980	364200-064
AF2081	364900-001
AF25042K	364200-020
AF25070K	364200-003
AF25220	364200-045
AF25279	364200-013
AF25280	364200-017
AF25287K	364200-041
AF25291	364200-039
AF25292	364200-026
AF25308	364200-010
AF25337	364200-008
AF25337M	364200-008
AF25352	364200-026
AF25437	364250-003
AF25442	364200-028
AF25477	364200-011
AF25484	380030-009
AF25485	364200-031
AF25497	364200-015
AF25519	364200-015
AF25523	364250-004
AF25526	364200-039
AF25538	364200-047
AF25550	364200-047
AF25551	142110
AF25554	364200-023
AF25555	364200-039
AF25556	380030-009
AF25565	364200-040
AF25575	142110
AF25578M	364200-037
AF25588	364200-039
AF25636	364200-043
AF25648	364200-008
AF25684	364700-002
AF25757	364200-043
AF25854	364200-019
AF25960	364250-002
AF26193	364200-014
AF26308	364200-043
AF284	364200-009
AF2974	364200-024
AF3286	364700-001
AF3497	364200-016
AF350K	364200-046
AF4059K	364200-036
AF4066	364200-027

OE Number	Crown Part Number
AF409K	364200-018
AF4102	364700-002
AF435K	364200-002
AF4536	364200-022
AF4573K	364200-025
AF4878	364200-045
AF4923K	364200-001
AF4924	364200-004
AF4941K	364200-018
AF70	364200-009
AF7996	364200-019
AG25576	364200-042
AH19065	364200-036
AH19066	364200-036
AH19083	142110
AH19084	142110
AH19085	142110
AH19086	142110
AH19091	364200-039
AH19092	364200-039
AH19093	364200-039
AH19094	364200-039
FF167	364300-003
FF185	364300-031
FF2203	364300-018
FF4062	364300-001
FF5018	364300-027
FF5038	364300-017
FF5052	364300-027
FF5056	364300-017
FF5103	364300-009
FF5160	364600-003
FF5245	364300-007
FF5300	364300-015
FF5320	364300-007
FF5421	364300-029
FF5494	364300-027
FL2271979	364200-026
FL26510342	364200-026
FL2976002	364200-026
FL2981113	364200-026
FL46562	364200-026
FL6005011111	364200-026
FL69800017	364200-026
FL7619404	364200-026
FL84036676	364200-026
FL873021003	364200-026
FL92793025	364200-026
FL9783	364200-026
FL993216	364200-026
FLAEM2668	364200-026
FLAF25292	364200-026
FLAF25352	364200-026
FLAF9969	364200-026
FLC17337	364200-026
FLCA5741	364200-026
FLDOP828889	364200-026
FLP770589	364200-026
FLP772580	364200-026
FLP774602	364200-026
FLP828889	364200-026
FLRS3544	364200-026
FLSA16580	364200-026
FLWGA1080	364200-026
FLX2950576	364200-026
FS1001	364300-004
FS1065	364300-030

SERVICE SUPPLIES

⚠ WARNING: Cancer - www.P65Warnings.ca.gov
 Note: More crosses available; contact your dealer.

Fleetguard Continued ▶

Filter Cross Reference

Fleetguard Continued

OE Number	Crown Part Number
FS1212	364300-024
FS1222	364300-024
FS1235	364300-005
FS1242B	364300-024
FS1280	364300-017
FS19514	364300-032
FS19516	364300-008
FS19530	364300-032
FS19534	364300-005
FS19616	364300-023
FS19811	364300-032
FS19814	364300-032
HF28783	364400-001
HF28853	364500-012
HF28857	364400-009
HF28946	364500-010
HF35005	364100-065
HF35006	364500-026
HF35102	364500-008
HF35140	364500-013
HF6005	364100-036
HF6067	364100-029
HF6080	364100-086
HF6133	364100-029
HF6137	364500-014
HF6149	364500-011
HF6177	364500-009
HF6202	364500-005
HF6206	364100-007
HF6252	364500-010
HF6337	364100-021
HF6505	364100-040
HF6517	364100-018
HF6552	364100-018
HF6710	364100-029
HF6711	364500-014
HF6749	364500-014
HF7534	364500-014
HF7904	364500-007
HF7926	364100-021
HF7947	364500-009
HF929	364100-006
LF115	364100-005
LF117	364100-016
LF155	364100-044
LF16011	364400-001
LF16015	364100-078
LF16104	364100-084
LF16176	364100-068
LF16224	364100-071
LF3306	364100-005
LF3309	364100-023
LF3310	364100-044
LF3311	364100-020
LF3314	364100-045
LF3328	364100-051
LF3335	364100-030
LF3336	364100-004
LF3338	364100-044
LF3339	364100-039
LF3341	364100-050
LF3342	364500-016
LF3345	364100-032
LF3349	364500-015
LF3361	364100-010
LF3364	364950-001
LF3377	364100-020

OE Number	Crown Part Number
LF3378	364100-020
LF3400	364100-020
LF3434	364100-001
LF3435	364100-037
LF3451	364100-045
LF3462	364100-046
LF3466	364100-034
LF3486	364100-003
LF3501	364100-050
LF3547	364100-051
LF3552	364500-015
LF3568	364100-022
LF3587	364100-051
LF3588	364100-051
LF3599	364100-009
LF3600	364100-013
LF3604	364100-023
LF3614	364100-041
LF3615	364100-041
LF3624	364100-047
LF3630	364100-091
LF3679	364100-048
LF3681	364100-049
LF3682	364100-081
LF3690	364100-017
LF3692	364100-065
LF3703	364100-028
LF3706	364100-081
LF3713	364100-025
LF3714	364100-047
LF3758	364100-050
LF3766	364100-044
LF3776	364100-008
LF3778	364100-080
LF3806	364500-015
LF3812	364100-008
LF3855	364400-001
LF385F	364100-001
LF3886	364100-078
LF3921	364500-015
LF3933	364100-037
LF3937	364100-083
LF3945	364100-084
LF3948	364100-011
LF3970	364100-083
LF4014	364100-044
LF4015	364100-020
LF402	364100-046
LF4095	364500-009
LF417	364100-014
LF42502	364100-019
LF488	364100-033
LF542	364100-002
LF574	364950-001
LF583	364100-012
LF607	364100-016
LF678	364100-052
LF67822	364100-052
LF681	364100-086
LF689	364100-050
LF700	364100-038
LF701	364100-026
LF701ER	364100-026
LF711	364100-024
LF716	364100-008
LF769	364500-005
LF780	364100-024

OE Number	Crown Part Number
LF785	364100-022
LF796	364100-019
LF798	364100-047
LF9024	364100-074
LFH4955	364100-029
PF2160	364500-012
WF1012	364900-001
WF2012	364900-001
WF2053A	364900-001
WF2061	364900-001
WF2073	364900-001
WF2125	364900-002
WF2126	364900-002
Ford (FD)	
11425472	364100-020
11464467	364100-050
11464498	364100-050
11525472	364100-050
130366060	364300-009
1419455	364200-046
1457512	364100-044
1482151	364100-050
1498017	364100-050
1498022	364100-044
1498435	364200-048
1508831	364100-050
1515160	364100-050
1520660	364100-050
1536304	364100-044
1553370	364100-044
1555451	364100-050
1559937	364100-044
1651563	364900-001
1696300351	364900-001
178562	364100-020
1S7Z-6731-DA	364400-001
2000E-9601-A	364200-046
200E-9601-A	364200-046
213188	364200-048
26550001	364900-001
3315115	364900-001
3963907	364100-026
3H-217	364200-046
40491	364900-001
457412	364500-009
5000185	364100-050
5000480	364100-044
5000513	364100-026
5000829	364950-001
5001156	364100-050
5001248	364100-050
5001753	364950-001
5002230	364100-050
5002454	364100-080
5002530	364100-044
5003329	364100-044
5003331	364100-044
5003455	364100-046
5003456	364100-008
5003607	364200-048
5003914	364100-044
5003929	364100-044
5003930	364100-044
5003967	364100-044
5003968	364100-044
5004264	364200-027
5004388	364100-008

OE Number	Crown Part Number
5004748	364950-001
5004926	364100-044
5004930	364100-050
5005079	364100-008
5005080	364100-008
5005572	364100-044
5006227	364100-047
5007123	364950-001
5007222	364100-050
5008589	364100-050
5008677	364100-050
5008720	364100-044
5008721	364100-044
5008722	364100-044
5009088	364100-044
5009421	364100-050
5010292	364100-017
5011322	364200-046
5011553	364200-046
5012037	364100-050
5012555	364100-044
5012580	364100-045
5013149	364100-050
5013319	364100-044
5018034	364300-013
5022798	364100-008
5023923	364300-013
542957	364100-020
5582	364250-001
6041176	364100-044
6063340	364100-050
6066094	364100-044
6066095	364100-044
6066096	364100-044
6123881	364300-024
70HM-6714-AA	364100-050
741M-6714-BA	364100-044
741M-6714-CA	364100-044
74HM-6714-BA	364100-026
78HM-6714-AA	364100-050
78TM-6714-BA	364100-050
81SM-6714-A3A	364100-044
81SM-6714-A4A	364100-044
83970552	364300-009
83971969	364900-001
83987767	364900-001
83DB-9155-AA	364300-024
949418	364900-001
9613322	364100-052
9613324	364100-026
9613327	364100-045
9832825	364200-048
9912-15115	364900-001
991215115	364900-001
9N-18632	364950-001
9N-18649	364950-001
9N-18658-A	364950-001
9N-18662	364950-001
9N-6123	364900-001
9N-6714	364950-001
9N-6731	364950-001
A690X-6A692-RA	364100-044
A700X-6714-AA	364100-044
A700X-6714-JA	364100-044
A700X-671DA	364100-080
A700X-6731-ADA	364950-001
A700X-6731-DA	364950-001

WARNING: Cancer - www.P65Warnings.ca.gov
Note: More crosses available; contact your dealer.

Ford Continued ▶

Filter Cross Reference

Ford Continued

OE Number	Crown Part Number
A700X-9601-ACA	364200-048
A720X-6714-FA	364100-044
A730X-6714-AA	364100-044
A730X-6714-BA	364100-026
A730X-6731-S1A	364950-001
A730X-6731-S2A	364950-001
A740X-6714-CA	364100-050
A740X-6731-KA	364950-001
A760X-6714-DA	364100-080
A760X-6714-KA	364100-044
A770X-6714-ABA	364100-044
A770X-6714-ACA	364100-044
A770X-6714-BA	364100-044
A770X-6714-DA	364100-044
A770X-6714-GA	364100-008
A770X-6714-NA	364100-044
A770X-6714-SA	364100-044
A770X-6714-TA	364100-044
A780X-6714-AA	364100-008
A780X-6714-EA	364100-044
A780X-6714-MA	364100-008
A780X-6714-NA	364100-008
A780X-6731-AA	364950-001
A780X-9601-CA	364200-027
A790X-6714-BA	364100-044
A790X-6714-CA	364100-044
A800X-6714-AA	364100-047
A800X-6714-EA	364100-080
A800X-6731-BA	364950-001
A810X-6714-JA	364100-044
A810X-6714-KA	364100-044
A810X-6714-LA	364100-044
A830X-9601-AFA	364200-046
A830X-9601-CDA	364200-046
AFL5033	364100-047
AFL56	364100-008
APN-18649	364950-001
APN-18649-B	364950-001
APN-6731-B	364950-001
C4R-9155-B	364300-034
C5ZZ-6731-A	364100-050
C6JZ-6714-A	364100-020
C6JZ-6714-B	364100-020
CCOZ-6714-AG	364100-020
D1RY-6731-A	364100-020
D27Z-6731-A	364100-008
D27Z-6731-ADP	364100-008
D4ZZ-6731-B	364100-050
D87Z-6731-A	364100-008
D8PJ-6714-AA	364100-020
D8PZ-6731-A	364100-020
D9HZ-6731-A	364500-016
D9HZ-6731-B	364500-016
D9PJ-6714-AA	364500-016
DITS-9600-AA	364200-046
DL-9601-A	364200-046
E3HZ-6731-C	364500-015
E73Z-6731-B	364100-047
E7GZ-6731-A	364100-046
E7HZ8A424A	364900-001
E7NN-6714-DA	364100-050
E8BZ-6731-A	364100-046
E8HZ-4A420-A	364100-050
E8NN-6714-CA	364100-020
E92Z-6731-A	364100-008
E92Z-9731-A	364100-008
E9GZ-6731-A	364100-065

OE Number	Crown Part Number
E9NN-6714-AA	364100-020
ET6-18660	364950-001
F1AE-6714-BC	364100-049
F1AZ-6731-A	364100-049
F1AZ-6731-BD	364100-049
F1HT-9155-BA	364300-024
F3HZ-6731-A	364500-015
F3HZ-6731-B	364500-015
F3HZ-6731-C	364500-015
F3HZ-8A424-D	364900-001
F3HZ-9162-A	364300-017
F3HZ-9601-A	364200-045
F3HZ-9601-B	364200-045
F3HZ-9601-C	364500-015
F3HZ-9601-D	364200-045
F3HZ-9601-DC	364200-045
FL322	364100-038
FL813	364100-047
KJ22065	364200-046
KOH-235116	364200-048
SBA130366050	364300-009
SBA130366060	364300-009
SBA140517020	364400-001
V104040	364900-001
V34778	364100-026
V79080	364300-024
V88833	364300-017
V88834	364300-027
Fram (FR)	
B328	364500-012
BPH43	364100-050
BT8417	364500-012
BT8417B	364500-012
C1191A	364300-003
C1723	364500-005
C1723A	364500-005
C3	364950-001
C3P	364950-001
C7330	364100-065
C827	364950-001
C842	364950-001
C891	364950-001
C988	364950-001
C988C	364950-001
CA19946	364200-053
CA120PL	364200-048
CA169	364200-049
CA169PL	364200-049
CA169PL2	364200-049
CA258SY	364200-064
CA4300	364200-027
CA5745	364200-039
CA649PL	364200-048
CA7111SY	364200-027
CA7139	364200-045
CA7242	364200-027
CA7695	364200-045
CA77	364200-048
CA770E	364200-048
CA8621	364250-003
CA8737	364200-026
CA8755	364200-043
CA8755A	364200-043
CA8756	364200-043
CA9248	364200-047
CA9268	364200-019
CA9269	364200-019

OE Number	Crown Part Number
CA9550	142110
CAK254	364200-046
CAK565	364200-036
CAK8390	364200-018
CH2870A	364100-022
CH2872	364100-009
CH6482	364500-011
CH8530	364100-068
DG16	364100-020
DG2	364100-049
DG2849A	364100-008
DG2870A	364100-022
DG3387A	364100-024
DG3675	364100-084
DG3682	364100-001
DG3950	364100-004
DG3980	364100-003
DG43	364100-050
DG4967	364100-041
DG6607	364100-065
DG7317	364100-065
F3P	364950-001
FA120PL	364200-048
G3	364300-034
G15	364300-034
GH110	364100-023
GH160	364950-001
HP-1	364100-034
K1532	364200-024
K3926	364300-024
LFP815F	364300-002
LFP815FN	364300-002
P16551A	364100-086
P16552A	364100-086
P16553A	364100-086
P16554A	364100-086
P2805	364100-016
P2814	364100-050
P29195	364200-018
P3415	364100-035
P3711	364300-027
P3761	364100-037
P3961	364500-014
P4157	364300-001
P4520	364300-013
P4688	364300-027
P4886	364600-003
P5068	364100-007
P5157	364300-015
P5158	364500-009
P6808	364500-009
P6881	364100-018
P7040	364500-014
P7510	364300-013
P7542	364500-014
P7559	364500-009
P8267	364500-009
P8317	364500-012
P8334	364300-007
P8707	364500-012
P9280	364100-037
P961PL	364100-050
PA2844	364100-042
PCS5059	364300-024
PCS5059M	364300-024
PCS5062	364300-024
PCS5062M	364300-024

OE Number	Crown Part Number
PER3911	364900-001
PF9715	364100-065
PH16	364100-020
PH16FP	364100-020
PH2	364100-049
PH20	364100-052
PH208	364100-052
PH20A	364100-052
PH228	364100-020
PH28001	364100-023
PH28032	364100-026
PH28041	364100-026
PH2806A	364100-023
PH2807	364100-050
PH2815	364100-045
PH2816	364100-023
PH2816S	364100-022
PH2820A	364100-020
PH2821C	364100-026
PH28231	364100-023
PH2832	364100-020
PH2835	364100-030
PH2840	364100-041
PH2844	364100-044
PH2849A	364100-006
PH2855	364100-020
PH2855A	364100-020
PH2857A	364100-023
PH2861A	364100-030
PH2861B	364100-050
PH2862C	364100-024
PH2863	364100-023
PH28631	364100-023
PH2868	364100-023
PH2870	364100-022
PH2870A	364100-022
PH2870B	364100-022
PH2871	364100-008
PH2879	364100-050
PH2885A	364100-075
PH2895	364100-038
PH2899	364100-050
PH28A	364100-039
PH2919	364100-080
PH2951	364100-017
PH2953A	364100-033
PH2954	364100-075
PH2957	364100-022
PH2964	364100-044
PH2978	364100-037
PH2990	364100-023
PH2993	364100-023
PH2FP	364100-049
PH3353	364100-019
PH3354	364100-024
PH3387	364100-024
PH3387A	364100-024
PH3387AFP	364100-024
PH3432	364100-019
PH35	364100-050
PH3503	364100-021
PH3506	364100-019
PH3508	364100-045
PH3512	364100-080
PH3516	364100-008
PH3519	364500-016
PH3519A	364500-016

⚠ WARNING: Cancer - www.P65Warnings.ca.gov

Note: More crosses available; contact your dealer.

Fram Continued ▶

Filter Cross Reference

Fram Continued

OE Number	Crown Part Number
PH3545	364100-051
PH3567	364100-029
PH3569	364100-045
PH3593A	364100-058
PH3614	364100-030
PH3651A	364100-037
PH3664	364100-047
PH3675	364100-084
PH3786	364100-091
PH3786FP	364100-091
PH3807	364100-008
PH3807A	364100-008
PH3816	364100-044
PH3900	364100-032
PH3917	364100-008
PH3946	364100-047
PH3976	364500-015
PH3976FP	364500-015
PH43	364100-050
PH4386	364100-011
PH43FP	364100-050
PH4469	364100-051
PH4478	364100-023
PH4482	364100-075
PH4557	364400-006
PH46A	364100-075
PH4703A	364100-047
PH4722	364100-024
PH4722A	364100-024
PH4743	364100-026
PH48	364100-050
PH4806	364100-080
PH4824	364100-020
PH4826	364100-013
PH4883	364100-022
PH4913	364100-008
PH4967	364100-041
PH4998	364100-065
PH5	364100-048
PH5195	364100-008
PH5491	364100-023
PH5693	364100-088
PH5FP	364100-048
PH6010A	364100-046
PH6017	364100-065
PH6017A	364100-065
PH6607	364100-065
PH6682	364100-022
PH6811	364100-046
PH7226	364100-023
PH7328	364100-020
PH7575	364100-030
PH8	364100-034
PH8026	364100-033
PH8476	364100-028
PH8942	364100-083
PH922A1	364100-020
PH9566	364400-001
PH961	364100-037
PH965	364100-020
PH966B	364100-044
PH966B11	364100-044
PH9715	364100-065
PH977A	364100-052
PH9837	364100-084
PR3392	364900-001
PR3910	364900-001

OE Number	Crown Part Number
PR8693	364900-002
PS3712	364300-024
PS7407	364300-008
PS8047	364300-004
PS9127	364300-032
S3TC	364950-001
TG3675	364100-084
TG4967	364100-041
TG6607	364100-065
TG7317	364100-065
XG2	364100-049
XG43	364100-050
XG5	364100-048
General Motors (GM)	
02971113	364300-031
0339-4112	364950-001
12339037	364100-008
12339909	364100-008
12339995	364100-041
1513904	364200-019
15153904	364200-019
15511626	364100-051
15516983	364300-024
1553681	364200-048
1553691	364200-048
15619013	364200-045
15696245	364200-045
15908916	364200-043
19166110	364200-043
21000872	364100-075
25010155	364950-001
25010157	364950-001
25010251	364100-019
25010277	364100-047
25010766	364100-024
25010964	364500-005
25010965	364500-005
25011099	364500-016
25011122	364500-016
25011130	364100-026
25011131	364100-026
25011159	364500-016
25011162	364100-052
25011165	364500-016
25011168	364100-086
25011229	364100-086
25011230	364100-086
25011292	364100-050
25011293	364100-050
25011354	364100-008
25011574	364100-008
25011689	364300-024
25011693	364300-024
25011902	364100-051
25011997	364500-015
25012001	364300-017
25012003	364300-027
25012355	364500-011
25012428	364500-009
25012488	364500-014
25012895	364900-001
25013977	364100-048
25014422	364100-065
25014520	364100-049
25014748	364100-084
25014818	364100-044
25026209	364100-047

OE Number	Crown Part Number
25096246	364200-027
25160561	364100-048
25161877	364100-046
25161878	364100-008
25161879	364100-008
25161880	364100-041
25171946	364100-065
25177526	364200-048
25312506	364500-016
25313348	364200-043
25313349	364200-043
25313741	364100-051
3448991	364100-045
3448992	364100-045
4984919	364100-045
5570003	364950-001
5570148	364950-001
5570234	364950-001
5570295	364950-001
5573444	364950-001
5577618	364100-020
5579164	364100-020
5646812	364200-049
5646813	364200-049
5648137	364200-049
5649798	364200-049
6420249	364200-049
6420322	364200-049
6421824	364200-048
6423028	364200-049
6423108	364200-048
6423122	364200-048
6423425	364200-049
64363832	364100-052
6437419	364100-020
6437968	364100-052
6438122	364100-086
6438162	364100-050
6439142	364100-050
6439143	364100-050
6439354	364100-047
6439355	364100-008
6439412	364950-001
6439517	364100-008
6439518	364100-008
6488346	364200-036
650352	364100-044
650362	364100-045
650364	364100-044
650365	364100-044
650373	364100-044
650400	364100-044
6696776	364100-044
7884256	364100-044
7965049	364100-044
7965051	364100-044
7973235	364100-044
7973429	364100-044
7984153	364100-080
7984229	364100-026
7984366	364100-050
7984452	364950-001
7984655	364100-045
81093682	364200-036
813566	364300-013
88971573	364100-041
893156634	364100-008

OE Number	Crown Part Number
90027778	364100-044
90166585	364300-013
9059521	364200-036
9059571	364200-036
91176162	364100-017
93156186	364100-075
93156299	364100-044
93156363	364100-045
93156665	364100-046
93156666	364100-008
93156670	364100-017
93156769	364100-047
93891769	364300-013
94037791	364100-051
9414941	364100-046
94149418	364100-046
94201942	364100-047
94412815	364100-008
94456741	364100-046
94459700	364100-008
94847351	364100-041
94851874	364100-041
94853643	364100-041
94858995	364100-041
96058042	364100-017
97182282	364100-045
9974200	364200-027
9975227	364100-075
9975267	364100-045
P2275	364500-012
V1119324	364100-050
Hyster (HY)	
0060518	364950-001
0060978	364950-001
0127644	364100-012
01328692	380030-180
0156391	364200-018
0156954	364200-046
0168031	364200-046
0169741	364100-005
0179952	364200-046
0179961	364200-046
0179967	364200-046
0180595	364100-007
0182490	364950-001
0230413	364300-001
0231488	364100-005
0258237	364100-037
0259964	364100-005
0295599	364200-005
0305080	364200-003
0309112A	364100-020
0324692	364100-008
0327645	364300-003
0333642	364100-006
0350073	364300-034
0369398	074105
0379411	364200-003
0385951	364300-027
0803864	364300-003
0804990	364950-001
0841244	364500-009
0993774	364950-001
127644	364100-012
1304953	364300-034
1304950	380030-047
1306331	364300-001

▲ WARNING: Cancer - www.P65Warnings.ca.gov

Note: More crosses available; contact your dealer.

Hyster Continued ▶

Filter Cross Reference

Hyster Continued

OE Number	Crown Part Number
1307931	364200-018
1320000	364100-003
1320000-M	364100-003
1324476	364600-003
1324476	364600-003
1327905	380103-911
1328691	364100-034
1328692	380030-180
1330033	364600-003
1334350	364600-003
1337159	380030-128
134887	364200-018
1350036	364100-043
1360190	364200-007
1360557	380030-128
1361808	364100-006
1368758	364600-003
1368795	364100-033
1368864	364100-020
1369809	364200-002
1369907	364100-006
1375550	364400-002
1377080	364200-010
1457828	364100-037
1462439	380030-123
1499886	364300-034
1507231	364250-004
1507234	364250-003
1507235	364250-004
1512123	364500-015
1512430	364300-017
1512454	364500-015
1524551	364100-083
1543356	364300-023
154818	364200-018
1553541	364300-034
1559418	380030-064
156172	364300-031
156391	364200-018
156931	364200-018
156954	364200-046
1574111	364200-032
1584120	380030-068
1588143	364500-015
1588825	364500-015
1620142	364250-001
1688246	364250-003
1688248	364250-003
169741	364100-005
170681	364200-018
1707194	380030-162
176683	364100-032
179952	364200-046
179955	364200-018
179967	364200-046
180282	364100-016
180283	364100-020
1804017	364500-012
180595	364100-007
182490	364950-001
182645	364200-046
194740	364500-012
195852	364100-026
201571	364300-001
2021461	364100-020
2021933	364500-003
2021935	380102-349

OE Number	Crown Part Number
2028654	364200-010
2033611	364200-002
2033682	364100-012
2034117	142110
2038072	364100-003
2039646	364500-010
2040364	364200-003
2040365	364200-026
2045606	364500-019
2048047	364200-042
2065754	364400-006
2067518	364400-006
2075558	364400-006
2070611	380030-162
2089366	364400-006
2305543	364100-035
2314368	364200-003
231488	364100-005
251755-12	364100-064
258237	364100-037
259025	364100-038
259264	364100-026
259964	364100-005
290732	364200-024
295599	364100-005
297865	364100-034
3000042	364500-009
3000043	364100-016
3000046	364100-005
3000047	364100-034
3000058	364100-050
3000059	364100-005
3000063	364500-012
3000065	364100-006
3000066	364100-007
3000068	364100-035
3000084	364500-011
3000107	364200-006
3000111	364200-009
3000227	364100-035
3000231	364100-038
3000240	077145
3000243	364100-004
3000244	364100-036
3000249	364100-038
3000328	364200-046
3000329	364200-003
3000331	364200-018
3000339	364200-007
3000340	364200-003
3000526	364200-003
3000538	077145
3000539	364100-001
3000856	364100-007
3000870	364100-064
3002377	077145
3002381	364200-002
3003599	364100-013
3005980	077145
3006174	364100-018
3006350	364500-012
3006884	074105
3006890	364200-004
3016477	364100-034
3019430	364500-016
3020819	364200-028
3020900	364600-003

OE Number	Crown Part Number
3020904	364200-001
3020906	364300-015
3020911	364200-002
3021036	364300-031
3027062	364300-031
3035679	364100-002
3035750	364200-003
3035751	364200-002
3035752	364100-016
3040015	364300-003
3040036	364100-005
3040047	364100-038
3040066	364200-002
3040204	364500-009
3040205	364500-011
3040874	364200-027
3040875	364300-003
3040987	364300-003
3041065	364200-016
3041500	364200-033
3041630	364100-030
3041828	364200-006
3041879	364300-003
3041904	364100-032
3042045	364100-032
3042059	364100-001
3042258	364500-012
3043552	364600-003
3044227	364200-001
3044229	364200-003
3044230	364100-009
3045509	364200-003
3049210	364300-015
305080	364200-003
3051156	364300-003
3051531	364200-046
3051790	364200-002
3051791	364100-016
3051792	364100-020
3051794	077145
3051898	364100-005
3052457	364100-038
3052867	364200-003
3052982	364200-002
3053707	364200-018
3065108	364500-003
3066680	364500-009
3070501	364900-001
3070503	364300-017
3071263	364300-024
309112	364100-020
3096293	364100-079
3101099	364100-044
3115428	364500-010
3120941	364400-007
3121285	364100-014
3121567	364300-027
3122704	364100-033
3123959	364100-035
3124027	364100-015
3125993	364100-036
3130925	364400-004
3131804	364500-015
3131805	364300-017
3133746	364300-015
3134130	364100-026
3135948	364100-038

OE Number	Crown Part Number
3135954	364200-010
313796	380030-128
3140102	364500-012
3140677	364400-001
3142480	364500-015
3142484	364300-017
3142965	364200-002
3143748	364500-012
3149713	364300-032
3172629	364500-003
324376	364200-002
324692	364100-008
326483	364200-002
327645	364300-003
333642	364100-006
336567	364200-024
342347	364300-015
369398	074105
375588	364100-003
379411	364200-003
385951	364300-027
4000997	380030-162
4020588	364400-006
4033254	364300-030
4090340	364100-092
4096874	364100-081
4105311	364200-052
42863BS	364100-026
5021	364100-026
60518	364950-001
60518-24	364950-001
60978	364950-001
80126812	364200-050
80143916	364200-050
803864	364300-003
804990	364950-001
841244	364500-009
8500023	364400-002
8528508	364400-006
865571	364300-001
865761	364200-002
993774	364950-001
S007624611	364200-039
Jungheinrich (JU)	
14043500	364300-003
140435002	364300-003
1404996	364200-027
14049960	364200-027
1410487	364200-018
14104870	364200-018
141048706	364200-018
1411463	364600-003
1432639	364100-036
14326390	364100-036
14341450	364300-003
1434228	364100-036
14342280	364100-036
1436599	364100-006
14365990	364100-006
143659900	364100-006
143659905	364100-006
1437927	364500-003
14379270	364500-003
1448305	364500-010
14483050	364500-010
14521664	364100-003
14712700	364600-003

SERVICE SUPPLIES

WARNING: Cancer - www.P65Warnings.ca.gov

Note: More crosses available; contact your dealer.

Jungheinrich Continued ▶

Filter Cross Reference

Jungheinrich Continued

OE Number	Crown Part Number
14712720	364600-003
14719480	364200-027
440052940	364200-027
50020152	364500-009
50021437	364200-039
50021439	380030-009
50033032	364200-026
50050362	364200-026
50158345	364200-027
50235644	364200-039
50235651	364500-016
50236415	380030-009
50237043	364200-040
52034015	364200-050
Kalmar LMV (KM)	
1005365	364200-018
114080	364500-009
119210	364500-012
1316602	364100-026
137769	364100-006
241672	364300-027
3911498	364300-023
3937743	364500-015
3991498	364300-023
4531050	364300-015
4942265	364100-001
4942657	364100-036
4948580	380030-124
4953804	380103-911
53103500	364100-086
800012640	364300-027
800033699	364300-017
800034641	364500-015
800040985	364300-024
807201965	364900-002
8761948	364100-014
8764816	380030-009
8764821	380030-123
8767408	364200-014
8775054	364100-015
8775086	364200-026
90005147	364500-016
90022191	364500-015
90023953	364200-045
90028099	364600-004
90028102	364500-015
90031010	364400-008
90031082	364300-023
90031133	364100-083
90031332	364300-029
90031366	364300-029
90031386	364400-008
90031422	364300-029
904352	364500-009
920040001	364500-009
920090001	364500-009
9209690035	364250-003
9211040001	364100-026
9213730003	364300-027
92247104500	364500-009
9231080699	364500-009
9231100577	364250-003
9231100578	364250-004
9231200407	364500-009
9234360720	364200-039
9234360721	380030-009
923829.0620	364100-083

OE Number	Crown Part Number
923829.0757	364350-001
923829.0829	364300-029
9238290616	364100-018
9238290620	364100-083
9238290757	364350-001
923829-0757	364350-001
9238290829	364300-029
923829-0829	364300-029
9239441474	364350-001
923976.1463	364300-023
923976.4754	364500-013
923976.5327	364300-029
9239761463	364300-023
9239765327	364300-029
923976-5327	364300-029
C906671	364400-008
C907045	364300-029
FS19616	364300-023
HGC257002	364500-009
LFF8062	364600-004
LFP780	364500-015
PEC114916	364100-026
PEC257003	364100-026
PEC257004	364100-038
SHP904352	364500-009
Komatsu (KO)	
0050782	364950-001
0056595	364950-001
0064127	364950-001
0064128	364950-001
0078230	364950-001
0078231	364950-001
0090825	364950-001
0098025	364950-001
0490015	364200-046
0507826	364950-001
0565955	364950-001
0641276	364950-001
0641285	364950-001
0782301	364950-001
0782310	364950-001
0782318	364950-001
0798025	364950-001
0908251	364950-001
0908258	364950-001
0980250	364950-001
0980256	364950-001
1085330	364200-011
1-13240-122-0	364100-051
1-13240-160-1	364100-051
1-13240-168-1	364100-051
11421-50280	364200-018
1196-60-35150	364100-046
1240483-H1	364300-024
1240621-H1	364500-015
129150-35151	364100-004
15000-2300	364100-001
15028-65011	364100-005
15028-H8903	364100-001
15208-01B01	364100-014
15208-01B02	364100-014
15208-01B02L	364100-014
15208-01B0B	364100-014
15208-01B0BL	364100-014
15208-13203	364100-001
15208-13210	364100-001
15208-13211	364100-001

OE Number	Crown Part Number
15208-13212	364100-001
15208-55Y00	364100-001
15208-65011	364100-005
15208-78203	364100-001
15208-H1010	364100-001
15208-H8903	364100-001
15208-H8904	364100-001
15208-H8911	364100-001
15208-H8916	364100-001
15208-H8920	364100-001
15208-W1103	364100-037
15208-W1106	364100-037
15208-W1120	364100-005
15208-W1120L	364100-005
15208-W1193	364100-005
16546-FJ170	364200-014
16919-W1602	364300-006
1894-91-1440	364100-065
190910-4	364950-001
1984-91-1440	364100-065
20501K1470	364100-026
20701K1230	364300-027
20801K1310	364300-024
21P01K1390	364300-027
21U6-011330	364100-083
2276	364200-002
2447281	364200-046
244728-1	364200-046
29901-55850	364600-003
30-118	364200-010
30-122	364200-007
304-913-1021	364200-002
305-913-1021	364200-002
30C-13-11520	364100-075
31-103	364100-038
31-105	364100-006
3193115	364950-001
319311-5	364950-001
32670-12620-7	364400-001
32670-12620-71	364400-001
344622	364200-046
34-702	364400-001
34-900	364400-004
34A-02-34130	364200-007
34B-02-31930	364200-002
34B-66-15180	364500-004
34C-02-45140	364200-003
34C-02-45150	364200-003
37Z-02-0F201	364100-001
37Z-02-0F201L	364100-001
37Z-02-0F301	364100-020
37Z-02-38730	142110
37Z-02-38770	364200-042
37Z-02-AF931	364200-002
37Z-02-AF931L	364200-002
37Z-02-AF932	364200-007
37Z-02-AF935	364200-002
37Z-02-OF201	364100-001
37Z-02-OF201L	364100-001
37Z-02-OF201LA	364100-001
37Z-02-OF301	364100-020
37Z-02-OF302	364100-011
3EA-01-16120	364200-007
3EA-01-A5390	142110
3EA-15-11600	364400-004
3EA-15-11610	364400-004
3EB-01-A5340	364200-002

OE Number	Crown Part Number
3EB-02-34750	364200-010
3EB-02-38730	142110
3EB-02-63210	364200-050
3EB-15-31550	364100-008
3EB-66-11710	364500-003
3EB-66-11711	364500-003
3EB-66-11711L	364500-003
3EB-66-A2320	364500-002
3EB-76-11711	364500-003
3EC-01-11730	364200-003
3EC-01-11730L	364200-003
3EC-01-11738	364200-003
3EC-01-52590	380030-009
3EC-01-90015A	380030-123
3EC-01-90020A	380030-009
3EC-02-19630	364200-003
3EC-02-A5230	364200-026
3ED-66-11330	364100-036
3ED-66-11330L	364100-036
3ED-66-11331	364100-036
3ED-66-11331L	364100-036
4006995	364300-031
4048147	364950-001
4048417	364950-001
42Y15-H0592	D501696
4348147	364950-001
4394407	364300-031
4396645	364100-089
43966456	364100-089
4502498	364950-001
4502498-4	364950-001
4502499	364950-001
4502499-4	364950-001
4953804	380103-911
507826	364950-001
540955	364950-001
545240	364950-001
600-181-7260	364200-003
600-181-7280	364200-003
600-181-7300	364200-003
600-181-7600	364200-003
600-211-1231	364100-089
600-211-2110	364400-001
600-211-5240	364100-086
600-211-5241	364100-086
600-211-5242	364100-086
600-211-5520	364600-003
600-211-6140L	364100-007
600-211-6141	364100-007
600-211-6240	364100-007
600-211-6241	364100-007
600-211-6242	364100-007
600-311-8140	364300-009
60031-18140	364300-009
600-311-8281	364300-031
600-311-8290	364300-031
600-311-8291	364300-031
600-311-8292	364300-031
6127-71-6090	364300-031
617966M	364950-001
6180-51-5130	364100-026
6610515050	364100-016
6610515300	364100-016
6732-71-6110	364300-027
6732-71-6111	364300-027
6732-71-6112	364300-027
6732716120	364300-017

WARNING: Cancer - www.P65Warnings.ca.gov
Note: More crosses available; contact your dealer.

Komatsu Continued ▶

Filter Cross Reference

Komatsu Continued

OE Number	Crown Part Number
6732-71-6320	364300-027
67355-15140	364500-015
6735-51-5140	364500-015
6735-51-5141	364500-015
67365-15140	364500-015
6736-51-5140	364500-015
6742-01-3790	364300-027
6754-71-6140	364300-014
6754-79-6130	364300-014
6754-79-6140	364300-014
6810-51-5130	364100-026
8764816	380030-009
8782852	364300-027
890321-H1	364200-046
8FG-123-8029A	364100-008
91220-10500	364100-004
9-14219-135-1	364200-018
AS15000-2300	364400-001
AS15000-2300A	364400-001
AS15000-2300L	364400-001
AX58828	364200-046
B4844	364950-001
BG8129832	364200-039
BG8876279	364200-039
BG8925297	380030-009
BL8619705	364300-003
BL8690958	364100-020
CU3315843	364300-024
CU3903410	364300-017
CU3903640	364300-027
CU3931062	364600-004
CUFF5052	364300-027
CUF51280	364300-017
DE48147	364950-001
DNP13D8627	364300-031
DTP1067	364300-027
DUP122510	364200-002
F3123567	364300-003
HE0256269-00	364100-020
HE40-0000407	364100-050
HE40-0000415	364100-050
L920090001	364500-009
L9234360720	364200-039
L9234360721	380030-009
OKR62189	364100-030
PK140516190	364100-075
TJ156017600871	364100-011
TJ15601-9600	364100-020
TJ1560-96001	364100-020
TJ90915-03001	364100-041
TJ90915-03004	364100-041
TJ90915-10002	364100-011
TK4781-14-302	364100-006
YM12910055650	364300-009
YM12911055650	364300-009
YM12915035151	364100-004
YM12990155850	364600-003
Z148943692993	364600-003
Z149091403004	364100-011
Z149091503004	364100-011
Z760234750	364200-039
Z760234790	380030-009
Z76-02-38730	142110
Z760238730	142110
Z7602AF932	364200-007
Z7602BX006	364200-010
Z7602BX106	364200-015

OE Number	Crown Part Number
Z761531550	364100-006
Z76-66-11711	364500-003
Z766611711	364500-003
Kubota (KB)	
1521332430	364100-022
1521511221	364200-007
1522111223	364200-007
1522111224	364200-007
1522211220	364200-007
1522211221	364200-007
1522211222	364200-007
1522211223	364200-007
1522211224	364200-007
1522211225	364200-007
1522711221	364200-007
1522787481	364200-007
1523111221	364200-007
15241-39092	364100-046
1524111017	364200-007
1527211222	364200-007
1531911221	364200-007
1532111011	364200-007
1532111221	364200-007
1532811221	364200-007
1534111221	364200-007
15400-67900-3	364100-046
15400-67901-3	364100-046
1545143560	364300-003
1550111080	364200-007
1550111220	364200-007
1556211080	364200-007
1584132430	364100-008
1585211220	364200-007
1585399170	364100-065
1585399179	364100-065
15906-32090	364100-044
1609749441	364200-018
1627132090	364100-008
1921511220	364200-007
1923787481	364200-007
30401-37580	364100-046
38087-21000	364100-046
401-42270	364200-038
445143560	364300-003
6609158220	364200-007
66201-36161	364100-017
6780058300	364200-007
6816143610	364200-007
6870162190	364500-003
6870162192	364500-003
70000-14640	364100-052
70000-14647	364100-045
70000-14653	364100-026
70000-32050	364100-046
7000014671	364100-003
76650-25430	364100-046
R140142270	364200-010
RD40142270	364200-038
TA04093230	142110
Z140F-10044	364100-026
Linde (LI)	
0001160024	364100-032
0001160243	364300-027
0001174423	364300-027
0009830532	364300-029
0009830600N	364100-026
0009830607	364100-045

OE Number	Crown Part Number
0009830621	364100-068
0009831415	364100-083
0009839012	364200-027
0009839012V	364200-027
001831605	364200-064
009839012	364200-027
0160000002	364100-032
0312225208N	364100-026
1160024	364100-032
1174418	364100-032
19831605	364200-064
2654403	364100-026
312225208	364100-026
56115561G	364100-001
68115561	364100-045
68115561B	364100-026
68115561BN	364100-026
68115561N	364100-026
7370	364950-001
737E03	364950-001
737E1	364950-001
7955000510	364100-032
9839012	364200-027
AE725006049	364100-044
F9454982	364500-009
FM8102165	364100-044
H17W04	364100-005
H17W05	364100-005
L0001160243	364300-027
L0001174423	364300-027
L0009830532	364300-029
L0009831415	364100-083
L0019831605	364200-064
L19831605	364200-064
PC202	364100-032
T001005003	364500-009
W94018	364100-032
XVW074115562	364100-068
Mann Filters (MV)	
45.3029292.1	364200-040
4530092911	364200-040
4530092941	364200-040
4920859101	364100-088
C1176-3	364200-027
C14200-1	364200-039
C14202-1	364200-039
C15300	364200-040
C16190FR	364200-041
CF850	380030-009
CF97	364200-015
H1041X	364950-001
HU726-2X	364100-068
MO-101	364950-001
P815K	364950-001
P815O	364950-001
P915N	364950-001
P915R	364950-001
P915T	364950-001
P925N	364950-001
PF915N	364950-001
PF925O	364950-001
PF925X	364950-001
PF926N	364950-001
W12901	364500-014
W1374-2	364500-009
W7121	364100-075
W71210	364100-075

OE Number	Crown Part Number
W81181	364100-075
W91411	364100-080
W91415	364100-075
W914-2	364100-050
W9144	364100-080
W9149X	364100-075
W916-1	364100-050
W920-12	364100-020
W920-21	364100-020
W920-23	364100-020
W920-26	364100-020
W920-70	364100-020
W920700	364100-020
W920-80	364100-050
W92099	364100-050
W930-8	364100-050
W9309	364100-020
W935-99	364100-050
W9407X	364300-031
W950-18	364500-015
WD930/26	364500-012
WF9140	364100-020
WF914-2	364100-020
WF916	364100-050
WF9160	364100-020
WF916-1	364100-020
WF91610	364100-020
WK719-6	364300-027
WK757	364300-027
WK8122	364300-032
WK8129	364300-032
WK832	364300-013
WK9503	364300-031
Mitsubishi (MB)	
0349804	364500-011
0363992	364500-009
0643736	364950-001
0687743	364200-046
0971289	364100-020
0971630	364100-023
0973352	380103-911
1015177	364400-007
1015623	364500-003
1032901	364300-015
1033660	364500-010
1037452	364400-007
1148105	364200-046
1157207	364400-007
1194740	364500-012
123-2367	364200-039
129675	364600-003
1348726	364200-050
1383100	364300-032
14049960	364200-027
14483050	364500-010
1634465	364300-032
1767710	364100-051
1A3479	364300-031
1N3224	364500-016
1P2299	364300-031
1R0711	364300-031
1R0713	364500-016
1R0714	364200-027
1R0740	364300-031
1R711	364300-031
1R713	364500-016
1W2638	364500-016

SERVICE SUPPLIES

▲ WARNING: Cancer - www.P65Warnings.ca.gov

Note: More crosses available; contact your dealer.

Mitsubishi Continued ▶

Filter Cross Reference

Mitsubishi Continued

OE Number	Crown Part Number
1W8633	364300-031
220900	364600-003
226-6561	364300-024
215999	364200-027
217724	364200-049
218005	364300-015
2W4246	364200-022
30030-76800	364200-046
30030-76801	364200-046
30462-72000	364300-003
30630-56800	364200-002
30A04-00100	364100-004
30A40-00100	364100-015
30A40-00101	364100-015
30A40-00102	364100-015
30A40-00105	364100-015
30H30-03710	364200-050
310266	364200-064
311300-2300	364200-046
32143-00200	364200-007
32414-300	364100-046
32540-11600D	364100-051
32B40-00100	364100-033
32B40-10100	364100-033
32C40-00100	364100-006
3358	364300-027
34462-00300	364300-015
34462-01040	364600-003
34462-01041	364600-003
34462-11040	364600-003
34462-21040	364600-003
34467-21040	364600-003
3473004500	364200-046
34740-00200	380103-916
349804	364500-011
34A40-00100	364100-015
363992	364500-009
38610107	364200-007
3G6337	364500-012
3G6925	364500-012
3G6928	364500-012
3I0721	364500-016
3I0743	364500-026
3I1156	364950-001
3I1178	364300-017
3I1179	364300-027
3I1305	364300-024
3I1312	364300-024
3I1327	364500-016
3I1365	364300-024
3I1367	364300-024
3I1550	364200-045
3I1571	364200-048
3I1660	364300-033
3I1663	364500-014
3I2013	364200-045
3I2132	364300-017
3R0711	364300-031
40633-96	364100-047
4T7948	364500-012
50020152	364500-009
50021437	364200-039
50021439	380030-009
50237043	364200-040
51209	364500-012
52034015	364200-050
566B1405	364100-076

OE Number	Crown Part Number
566B7177	364100-083
566B7290	364100-075
566BD7176	364100-074
566BF1212	364300-024
566BF1280	364300-017
566BF7681D	364300-032
566BF7760	364300-018
566BF788	364300-027
566BF970	364300-031
566BF995	364300-033
566BT38910	364500-014
566BT7237MPG	364100-078
566BT8416	364500-026
566BT8417	364500-012
566BT8454	364500-013
566BT8833	364400-009
566BW5086	364900-002
566PA2570	364500-064
566PA678	364200-048
566RS3705	364200-042
566RS3745	364250-004
5882210072	364400-007
5A6717	364300-031
636082	364950-001
643736	364950-001
6562505300	364100-006
673217	364200-046
682994	364200-046
687743	364200-046
6A5162	364200-027
6E0924	364500-012
6E0925	364500-012
6E924	364500-012
6G924	364500-012
6L7440	364300-031
6N3784	364300-031
6V5875	364500-016
77-8190	364500-016
7W2326	380103-911
817003	364100-075
89424-35020	364100-004
8L9765	364300-031
8N9586	364500-016
8N9856	364500-016
8T7427	364500-016
90425-01750	364100-015
90425-08220	364300-006
91220-10500	364100-004
91224-07100	364400-007
91224-07101	364400-007
91261-00040	364200-028
91261-00041	364200-028
91261-00700	364200-002
91261-06200	380100-090
91261-06700	364200-028
91265-09700	364300-006
91275-03300	364500-003
91275-03301	364500-003
91275-13000	364500-003
91275-13300	364500-003
91275-13301	364500-003
91375-03800	380030-114
91461-01500	364200-003
91861-01600	364200-041
91875-01400	364500-010
91875-05900	364500-010
91875-11400	364500-010

OE Number	Crown Part Number
91A65-00611	364300-006
91B61-00112	142110
91B61-00912	364200-014
91K61-01700	380030-009
91K61-02112	380030-123
91K61-02300	380030-009
925952	364100-015
94611-11500	364200-003
971289	364100-020
971630	364100-023
9G6926	364500-012
9N5570	364500-016
9-N-5570	364500-016
9N9586	364500-016
9Y4431	364300-024
9Y4432	364300-024
9Y4464	364100-089
9Y4499	364950-001
9Y6823	364200-064
9Y6838	364200-046
A0000-00313	364100-016
A0000-01339	364100-079
A0000-02806	364200-008
A0000-03458	142110
A0000-09241	364500-015
A0000-14210	364100-091
A0000-14472	364950-001
A0000-14514	364100-084
A0000-14529	364200-043
A0000-15358	364200-045
A0000-15983	364200-050
A0000-15986	364200-047
A0000-16007	364300-017
A0000-16048	364300-024
A0000-16115	364300-023
A0000-16133	380030-009
A0000-16205	380030-009
A0000-19497	364200-050
A0000-26444	380030-162
A0000-26485	364400-006
A0000-26486	364500-015
A0000-26490	364400-006
A0000-26588	380030-162
A0000-26778	364300-032
A0000-27284	364100-078
A0000-29035	364200-048
A0000-29038	364200-047
A0000-29315	364100-083
A0000-31488	364250-004
A0000-31589	364500-012
A0000-31655	364100-089
A0000-36418	364500-015
A0000-37496	364250-002
A218869	364200-029
A218870	364200-030
A643736	364950-001
AW343979	364100-067
D001445	364100-004
D001450	364100-004
DO1450	364100-047
GE924	364500-012
K4662010	364100-004
K4732350	380030-009
K486201	364100-004
K4862010	364100-004
K4862011	364100-047
K9665400	364100-046

OE Number	Crown Part Number
LE3ADG6926	364500-012
LM40DQ9804	364500-011
LM4AHN9027	364200-016
LM4AHW2327	364100-005
LM4AJN5504	364200-006
LM4ODQ9804	364500-011
M12004311	364200-010
MD014450	364100-047
MD-031805	364100-004
MD129809	364100-030
MD136466	364100-002
MD136790	364100-046
MD321589	364100-067
MD332687	364100-002
MD352626	364100-002
MD352627	364100-067
MD356000	364100-046
MD365876	364100-002
MD409365	364100-046
ME033617	364200-046
ME034878	364100-051
ME060219	364200-046
MM433093	364300-009
MO-031805	364100-015
TC01124	364100-004
TM225L217	364950-001
XD00145	364100-006
Moffett (ZM)	
15521-43160	364300-009
17321-32430	364100-081
RD401-42270	364200-038
NAPA (NP)	
1010	364950-001
1037	364100-024
1040	364100-024
1040MP	364100-024
1041	364100-019
1042	364100-019
1060	364100-048
1064	364100-002
1068	364100-020
1069	364100-012
1083	364100-006
1084	364100-020
1085	364100-023
1085MP	364100-023
1191	364100-045
1240	364100-036
1243	364100-052
12435	364100-052
1243MP	364100-052
1248	364500-016
1268	364500-016
1288	364100-044
1307	364100-020
1311	364100-020
1316	364100-020
1334	364100-046
1334MP	364100-046
1335	364100-080
1344	364100-008
1347	364100-008
1348	364100-030
1348MP	364100-017
1358	364100-065
1372	364100-049
1372MP	364100-049

▲ WARNING: Cancer - www.P65Warnings.ca.gov

Note: More crosses available; contact your dealer.

NAPA Continued ▶

Filter Cross Reference

NAPA Continued

OE Number	Crown Part Number
1394	364100-041
1395	364100-041
1422	364100-035
1453	364100-086
1460	364100-038
1516	364100-039
1521	364100-020
1522	364100-084
1522MP	364100-084
1545	364100-034
1568	364100-008
1594	364500-018
1602	364100-032
1604	364500-015
1607	364500-015
1607MP	364500-015
1622	364100-034
1626	364100-047
1650	364100-035
1663	364100-036
1723	364500-011
1734	364100-091
1734MP	364100-091
1746	364100-029
1759	364100-029
1775	364100-005
1785	364100-030
1798	364100-051
1806	364100-026
1806MP	364100-026
1858	364500-009
202150	364100-050
2087	364200-049
21060	364100-048
21068	364100-050
21307	364100-020
21334	364100-046
21334MP	364100-046
21347	364100-008
21348	364100-017
21348MP	364100-017
21356	364100-015
21365	364100-065
21372	364100-049
21372MP	364100-049
21380	364100-047
21452	364100-045
21521	364100-037
21522	364100-084
21626	364100-047
2234	364200-046
22487	364200-043
2276	364200-002
23003	364300-034
2373	364200-048
2375	364200-048
2487	364200-043
2488	364200-043
2518	364200-024
26253	364700-002
2654033	364100-026
26573	364200-019
2803	364250-003
2804	364250-004
2868	364200-036
3003	364300-034
3033	364300-034

OE Number	Crown Part Number
3091	364300-023
3192	364300-005
3352	364300-031
3356	364300-007
3357	364300-017
3357MP	364300-017
3358	364300-027
3358MP	364300-027
3394	364300-015
3405	364300-024
3405MP	364300-024
3415	364300-024
3431	364300-024
3507	364300-009
3528	364300-007
3531	364300-008
3535	364300-032
3547	364300-032
3632	364300-032
3637	364300-032
3691	364300-018
3777	364300-027
3965	364300-030
4112	364900-002
6313	364200-027
6375	364200-064
6433	364200-045
6438	142110
6439	364200-014
6449	364200-047
6483	364200-037
6490	364200-015
6562	364200-026
6573	364200-019
6652	364200-039
6671	364200-039
6672	380030-009
6836	364200-040
7025	364500-012
7037	364100-078
7092	364100-071
7116	364500-012
7181	364400-001
7182	364100-083
7210	364100-068
7220	364400-003
7411	364100-033
7723	364500-013
7740	364400-008
M46360	364200-002
NA-1394	364100-014
Nissan (NI)	
11720-06000	364100-032
15201-Z9010	364100-051
15208-01B01	364100-014
15208-01B02	364100-014
15208-01B10	364100-014
15208-01B15	364100-075
15208-01B0B	364100-014
15208-08901	364100-001
15208-13201	364100-001
15208-13213	364100-001
15208-29D00	364100-037
15208-31401	364100-015
15208-31U00	364100-015
15208-31U01	364100-015
15208-43G00	364100-005

OE Number	Crown Part Number
15208-43G0A	364100-005
15208-65014	364100-005
15208-65F00	364100-065
15208-65F01	364100-065
15208-80W00	364100-037
15208-9C600	364100-020
15208-H1000	364100-001
15208-H1011	364100-001
15208-H1111	364100-037
15208-H8911B	364100-001
15208-H8923	364100-001
15208-H8994PC	364100-001
15208-W1101	364100-037
15208-W1103PC	364100-037
15208-W1120PC	364100-005
15208-W1123	364100-005
15208-W8916	364100-037
15208-Y9701	364100-026
15209-10H00	364100-001
15209-10H00B	364100-001
15209-J5602	364100-032
16404-78225	380030-124
16404-K4046	380030-124
16404-L1100	380030-124
16405-FM000	364600-003
16444-29000	364300-001
16444-99425	364300-031
16444-99525	364300-031
16546-00H03	364200-002
16546-00H03B	364200-002
16546-00H10	364200-001
16546-00H10-B	364200-001
16546-00H10B	364200-001
16546-05H10	364200-001
16546-0K000	364200-001
16546-1G000	364200-002
165461G000	364200-002
16546-40K00	364200-033
16546-51H10	364200-033
16546-51H10D	364200-033
16546-GL11A	380030-123
16546-L8010	364200-018
16546-L9010	364200-018
16546Z5005	364200-046
16919-N7000	364300-006
16919-N7001	364300-006
16919-W1601	364300-006
16919-W1602	364300-006
17741-30510	364200-026
1806	364100-026
20801-01361	364100-014
2782050	364100-079
2792962	364100-079
28719-20M1	364200-046
31728-11H01	380102-334
31728-40K00	380102-334
31728-FJ100	364400-007
41524-1060	364100-046
43820003	364100-015
53651-72061	364200-014
53651-72161	364200-014
58395-91H01	364100-007
58396-47601	364100-007
58396-47601-B	364100-007
58396-91H10	364100-007
6011-10240	364100-015
6032-10520	364100-079

OE Number	Crown Part Number
6041-10220	364500-003
69220-6K200	364500-003
69220-FK100	380030-114
91224-07101	364400-007
A5208-W1103	364100-020
A5208-W1106	364100-020
A6405-FM000	364600-003
CK1804057	364100-006
CK2792962	364100-079
CK2816961	364100-079
CK854571	364950-001
CK918648	364100-002
FL40399008	364300-031
NF32B40-00100	364100-033
NF34462-00300	364300-015
NF90425-08220	364300-006
NF91224-07101	364400-007
NF91861-05600	364200-018
NF91875-05900	364500-010
NF91875-11400	364500-010
NFMD352626	364100-002
PA1690-FN	364200-002
Purolator (PU)	
30137	364100-026
4611641	364300-031
6665973	364100-016
6665976	364100-012
6665979	364100-044
6665982	364300-031
6675008	364100-037
6675578	364300-031
6675582	364300-031
6675584	364300-031
6675586	364300-031
6675912	364200-003
6681138	364100-086
6685817	364300-031
6694036	364300-031
6694095	364300-002
6934761	364200-049
6938155	364500-015
9309481	364200-048
A20055	364200-049
A22011	364200-007
A23496	364200-006
A27758	364200-027
A35167	364200-022
A35270	364200-047
A35300	364200-001
A40012	364200-048
A42019	364200-002
A43458	364200-064
A45314	364200-043
A52040	364200-018
A53511	364200-064
A55400	364200-019
A62044	364200-036
A62974	364200-024
A64699	364200-045
A65351	364200-031
A75173	364200-004
AF2011K	364200-007
AF2093	364100-022
AF4425	364200-027
AFP12	364200-048
AFP55K	364200-049
AFP69	364200-048

SERVICE SUPPLIES

WARNING: Cancer - www.P65Warnings.ca.gov

Note: More crosses available; contact your dealer.

Purolator Continued ▶

Filter Cross Reference

Purolator Continued

SERVICE SUPPLIES

OE Number	Crown Part Number
EP221	364300-001
EP221N	364300-001
F50022	364300-031
F50086	364300-001
F50149	364300-003
F50221	364300-001
F50284	364300-031
F54423	364300-017
F54424	364300-027
F54557	364300-009
F55110	364300-008
F55190	364300-032
F55294	364300-032
F55325	364300-005
F57174	364300-003
F57248	364300-001
F57507	364300-003
F57629	364300-003
F57805	364300-001
F57851	364600-003
F59221	364300-001
F60024	364300-024
F60032	364300-031
F60038	364300-031
F60043	364300-017
F60053	364300-031
F60152	364300-001
F60217	364300-001
F60222	364600-003
F60231	364300-031
F64863	364300-017
F65213	364300-031
F67803	364300-001
F70062	364300-031
F78367	364300-001
FC0258	364100-075
FC101	364100-050
FC114	364100-075
FC1141	364100-075
FC140	364100-020
FC141	364100-075
FC142	364100-006
FC603	364400-002
FC81	364400-002
FC A3398	364100-009
FCG152	364300-001
FCO0291	364100-006
FCO101	364400-002
FCO160	364100-004
FCO167	364100-006
FCO17	364100-020
FCO18	364100-020
FCO201	364100-044
FCO213	364100-022
FCO2166	364100-001
FCO2167	364100-037
FCO252	364100-022
FCO257	364100-045
FCO28	364100-044
FCO321	364100-008
FCO64	364100-009
FCO73	364100-008
FPT750	364100-016
FPT750B	364100-016
FPT750H	364100-016
GP24	364300-024
H20294	364500-012

OE Number	Crown Part Number
H30059	364100-086
H30135	364100-035
H32210	364100-036
H35235	364100-018
H40029	364100-029
H40175	364500-009
HOT81	364100-050
L10017	364100-020
L10018	364100-020
L10101	364100-050
L10111	364100-024
L10112	364100-024
L10193	364100-004
L14006	364100-019
L14459	364100-002
L14476	364100-041
L14477	364100-011
L14610	364100-015
L14620	364100-015
L14622	364100-015
L14670	364100-023
L17603	364400-002
L20064	364100-009
L20081	364100-050
L20173	364100-003
L20252	364100-022
L20287	364100-013
L22167	364100-037
L24007	364100-019
L24011	364100-003
L24458	364100-008
L24466	364100-022
L25100	364500-012
L27159	364100-004
L27190	364100-022
L30015	364100-052
L30054	364100-007
L30068	364100-051
L30138	364100-038
L30215	364500-016
L30257	364100-045
L34480	364100-013
L34631	364100-048
L35197	364100-028
L37735	364100-068
L39001	364100-034
L44422	364500-015
L45308	364100-068
L60750	364100-016
L60751	364100-016
LI3550	364100-020
LI3968	364100-023
LI4117	364100-020
LI4218	364100-023
LX272	364200-027
MF36300A	364100-020
MF36304B	364100-020
MF45800A	364100-020
MF53400A	364100-023
MF6103	364100-030
MF6200A	364100-075
MF63000	364100-044
MF63000A	364100-044
MF63005A	364100-022
MFF629A	364300-003
ML16810	364100-046
ML16817	364100-065

OE Number	Crown Part Number
ML16819	364100-065
OC47	364100-022
OC49	364100-022
P25288	364100-084
PC20	364100-050
PC201	364100-044
PC200F	364100-044
PC21	364100-044
PC2130F	364100-022
PC218	364100-020
PC22	364100-020
PC222	364100-007
PC23	364100-020
PC237	364100-026
PC238	364100-038
PC252	364100-022
PC253	364100-022
PC258	364100-075
PC265	364100-023
PC27	364100-020
PC32	364100-020
PC32/1	364100-044
PC38	364100-020
PER101	364100-050
PER111	364100-024
PER112	364100-024
PER124	364100-019
PER151F	364300-001
PER152F	364300-001
PER159	364100-004
PER163	364100-075
PER168	364100-044
PER17	364100-020
PER170	364100-023
PER175H	364500-009
PER175HMIC10	364500-009
PER179	364100-044
PER17K	364100-044
PER17M	364100-020
PER18	364100-020
PER188	364100-022
PER190	364100-022
PER194	364100-004
PER211	364100-044
PER215	364500-016
PER2167	364100-037
PER217F	364300-001
PER232	364300-031
PER241	364100-017
PER244	364100-024
PER247F	364300-001
PER249F	364300-001
PER252	364100-022
PER257	364100-045
PER268	364100-017
PER270	364100-004
PER275	364100-023
PER276	364100-044
PER277	364100-020
PER28	364100-044
PER287	364100-013
PER289	364100-004
PER291	364100-006
PER294	364500-012
PER307	364100-024
PER321	364100-008
PER323F	364300-013

OE Number	Crown Part Number
PER34	364300-031
PER349	364100-047
PER36	364300-031
PER362	364100-022
PER367F	364300-001
PER37	364300-031
PER38	364300-031
PER393	364100-004
PER4000	364100-037
PER4007	364100-019
PER4011	364100-003
PER40M	364100-037
PER43	364300-017
PER4423F	364300-017
PER4458	364100-008
PER4459	364100-046
PER4466	364100-022
PER4476	364100-041
PER4477	364100-011
PER4619	364100-004
PER4622	364100-065
PER4631	364100-048
PER4651	364100-049
PER4670	364100-023
PER53	364300-031
PER58	364100-050
PER59	364100-086
PER62	364300-031
PER63	364300-031
PER-73	364100-006
PER73	364100-008
PER74	364100-008
PER76	364300-031
PER-81	364100-020
PER81	364100-050
PER86	364300-001
PF3146	364300-003
PF3174	364600-003
PF4557	364300-009
PIL25	364100-023
PIL29	364100-023
PIL32	364100-023
PL10017	364100-020
PL10111	364100-024
PL14006	364100-019
PL14476	364100-041
PL14612	364100-065
PL14619	364100-047
PL14622	364100-065
PL20064	364100-039
PL20081	364100-050
PL20252	364100-022
PL22167	364100-037
PL24458	364100-008
PL24651	364100-049
PL25288	364100-084
PL34631	364100-048
PL4670	364100-023
PM1031	364200-048
PM1758	364200-027
PM206A	364100-075
PM6056	364500-011
PMP322	364100-020
SK221102	364100-026
T134	364100-023
T750	364100-016
TB0816	364100-050

⚠ WARNING: Cancer - www.P65Warnings.ca.gov

Note: More crosses available; contact your dealer.

Purolator Continued ▶

Filter Cross Reference

Purulator Continued

OE Number	Crown Part Number
TBO111	364100-024
TBO17	364100-020
TBO241	364100-075
TBO81	364100-050
Raymond (RA)	
1012615-003	370511
1023832-003	370511
1024373-003	370511
520-509-01	077145
520-512	364100-036
520-528	077145
520-610	077145
520-610-01	077145
850-508	074105
850-516	074105
850-521	074105
850-522	074105
850-523	074105
DS223161	074105
DS232176	077145
TCM (TC)	
112T2-52501	364400-001
11421-50320	364200-018
115G3-82241	364400-001
115G3-82241R	364400-001
12163-82301A	364100-006
16444-99425	364300-031
16444-99525	364300-031
1K011-43060	364600-003
20103361	364200-010
20801-01041	364100-001
20801-01281	364100-015
20801-01361	364100-014
20801-01431	364100-002
20801-02061	380030-124
20801-02141	364600-003
20801-03061	364200-018
20801-03081	364200-046
20801-03131	364200-002
20801-03131R	364200-002
20801-03132	364200-002
20801-03221	364200-003
20801-03271	364200-001
20801-03311	364200-002
20801-03351	142110
20801-03351A	142110
20801-03351R	142110
20801-03361	364200-050
20801-03361A	364200-050
20801-03511	364200-026
212T1-05851	364100-011
212T1-05851R	364100-011
213T1-02011	142110
214A1-02601	364200-003
230C1-02061	364200-026
23441-00422	364200-002
25601-08011	142110
256C1-08011	142110
256C1-08011UL	142110
256G1-08011	364200-010
26402-37011	364200-026
2782050	364100-079
2792962	364100-079
513A0-52391	364300-006
513A0-52391	364300-006
89433-17480	364600-003
89436-91993	364600-003

OE Number	Crown Part Number
89436-92990	364600-003
89436-92992	364600-003
89436-92993	364600-003
A1R0750	364300-031
AE-602950106	364100-008
CK2792962	364100-079
CK2816961	364100-079
CK854571	364950-001
DET000124	364200-018
E602950106	364100-006
FA3651-72061	142110
FL40399008	364300-031
N-15208-01B01	364100-014
N-15208-13210	364100-001
N-15208-13211	364100-001
N-15208-13212	364100-001
N-15208-65011	364100-005
N-15208-65014	364100-005
N-15208-H1000	364100-001
N-15208-H1010	364100-001
N-15208-H1011	364100-001
N-15208-H8911	364100-001
N-15208-H8916	364100-001
N-15208-W1103	364100-037
N-15208-W1123	364100-005
N-16546-00H10	364200-001
N-16546-51H10	364200-033
N-16919-W1602	364300-006
P-10-4972	364200-018
P-10-5629	364200-002
P-12-2514	364200-002
P181054	364200-018
T-4781-14-302	364100-015
T-F2SM-13-Z40	364200-002
Z8943212191	364100-033
Z8944160690	364100-033
Z9142-15135	364200-018
Z-9-14215-135-1	364200-018
Tennant (TN)	
235116	364200-048
35254	364200-002
369746	364200-014
48127	364200-002
515601	364200-002
515601-1	364200-002
51561	364200-002
51561-1	364200-002
54141	364200-002
54141-1	364200-002
541414	364200-002
54141M	364200-002
55849	364100-008
58120	364200-002
10507733	364100-080
Toyota (TY)	
00591-00111-81	364100-035
00591-01197-81	364200-024
00591-01965-81	364200-004
00591-02197-81	364200-024
00591-02570-81	364100-018
00591-02587-81	364100-079
00591-02700-81	364100-038
00591-03681-81	364100-026
00591-03688-81	364100-052
00591-03784-81	364300-017
00591-03871-81	364100-002
00591-03894-81	364200-046

OE Number	Crown Part Number
00591-03998-81	364100-034
00591-05332-81	364500-012
00591-05337-81	364200-013
00591-05338-81	364200-017
00591-05449-81	364200-016
00591-05672-81	364100-006
00591-06175-81	364100-038
00591-06188-81	364100-020
00591-06344-81	364200-003
00591-06347-81	364100-080
00591-06549-81	364200-028
00591-06550-81	364200-011
00591-07056-81	364200-003
00591-07057-81	364200-002
00591-10935-81	364100-030
00591-11044-81	364100-006
00591-14062-81	364400-004
00591-14063-81	364100-036
00591-14066-81	364600-003
00591-14090-81	364500-011
00591-14820-81	364100-035
00591-19020-81	364100-005
00591-20166-81	364300-015
00591-20222-81	364500-009
00591-20312-81	364200-003
00591-20758-81	364500-004
00591-22139-81	364100-037
00591-22155-81	364200-023
00591-22159-81	364200-020
00591-22303-81	364100-041
00591-22391-81	364100-035
00591-27216-81	364200-029
00591-27326-81	364500-003
00591-27399-81	364950-001
00591-27449-81	364100-016
00591-30483-81	364100-015
00591-30899-81	364200-033
00591-31053-81	364200-011
00591-31302-81	364100-002
00591-32747-81	364200-009
00591-32750-81	364200-002
00591-32752-81	364200-003
00591-32762-81	364100-006
00591-32763-81	364100-004
00591-32769-81	364100-037
00591-32771-81	364100-007
00591-32772-81	364200-004
00591-32776-81	364200-027
00591-32785-81	364100-035
00591-32786-81	364100-034
00591-32791-81	364200-006
00591-32795-81	364100-007
00591-32796-81	364100-006
00591-32798-81	364100-002
00591-32799-81	364100-006
00591-32800-81	364100-012
00591-32801-81	364100-035
00591-32807-81	364600-003
00591-32808-81	364200-001
00591-32810-81	364200-016
00591-32817-81	364100-003
00591-32821-81	364100-013
00591-32826-81	364200-024
00591-32827-81	364200-003
00591-32828-81	364100-006
00591-34081-81	364100-044
00591-34082-81	364100-038

OE Number	Crown Part Number
00591-34092-81	364100-022
00591-34096-81	364200-046
00591-34113-81	364100-020
00591-34115-81	364100-026
00591-34131-81	074105
00591-34137-81	364500-009
00591-34138-81	364100-018
00591-34140-81	364100-001
00591-34145-81	364500-011
00591-34150-81	364500-012
00591-34151-81	364200-007
00591-34156-81	364200-024
00591-34161-81	364500-012
00591-34162-81	364200-013
00591-34165-81	364100-017
00591-34167-81	364200-028
00591-34170-81	364100-020
00591-34176-81	364100-036
00591-34177-81	364100-014
00591-34180-81	364200-017
00591-34181-81	364200-010
00591-34190-81	364400-002
00591-34191-81	364500-003
00591-34192-81	364100-015
00591-42846-81	364100-009
00591-42847-81	364200-023
00591-45311-81	364200-020
00591-45315-81	142110
00591-45329-81	364400-007
00591-50320-81	364200-033
00591-50593-81	364200-003
00591-50594-81	364200-001
00591-50596-81	364200-046
00591-50598-81	364200-002
00591-50599-81	364200-009
00591-50602-81	364200-007
00591-50610-81	364100-016
00591-50614-81	364100-007
00591-50615-81	364100-001
00591-50617-81	364100-006
00591-50619-81	364100-035
00591-50623-81	364100-038
00591-53022-81	364100-013
00591-53048-81	364500-009
00591-53072-81	364500-012
00591-53079-81	364200-016
00591-53084-81	364100-018
00591-53316-81	364100-034
00591-53318-81	364100-009
00591-53498-81	364300-031
00591-54428-81	364200-028
00591-54432-81	364100-035
00591-54435-81	364200-011
00591-54436-81	364100-015
00591-54440-81	364100-017
00591-54443-81	364100-012
00591-54444-81	364100-012
00591-54446-81	364100-006
00591-54457-81	364100-006
00591-54458-81	364100-002
00591-54459-81	364100-020
00591-54465-81	364500-011
00591-54469-81	364500-012
00591-54473-81	077145
00591-54474-81	364100-020
00591-54475-81	364100-036
00591-54479-81	364500-003

SERVICE SUPPLIES

⚠ WARNING: Cancer - www.P65Warnings.ca.gov

Note: More crosses available; contact your dealer.

Toyota Continued ▶

Filter Cross Reference

Toyota Continued

OE Number	Crown Part Number
00591-54481-81	364300-015
00591-54483-81	364200-010
00591-54489-81	364200-011
00591-54490-81	364100-014
00591-54491-81	364200-017
00591-54494-81	364400-002
00591-54495-81	364100-015
00591-59425-81	364100-003
00591-59433-81	364100-034
00591-61126-81	364100-035
00591-61171-81	364600-003
00591-62086-81	364200-004
00591-62213-81	364100-079
00591-62751-81	364100-029
00591-63185-81	364200-027
00591-63204-81	364100-001
00591-63387-81	364200-003
00591-63592-81	364200-049
00591-63602-81	364100-036
00591-63696-81	364100-006
00591-64106-81	364100-026
00591-64503-81	364100-002
00591-71906-81	364600-003
00591-72357-81	364100-048
00591-72359-81	364100-051
00591-72362-81	364100-089
00591-72364-81	364600-004
00591-72367-81	364300-031
00591-72368-81	364100-030
00591-72372-81	077145
00591-72387-81	364200-015
00591-74725-81	074105
00591-76662-81	364400-002
00591-76870-81	364500-010
04234-76001-71	380030-124
04234-76002-71	380030-124
04234-76003-71	380030-124
08922-02001	364100-011
08922-02002-71	364100-011
08922-02004	364100-030
08922-02011	364100-041
10115-88420-71	364300-009
11501-01211-71	364100-004
11501-01390-71	364100-011
11501-01660-71	364100-011
11501-01670	364100-041
11531-00042-71	364100-037
12968-712510	364200-050
15600-01020-71	364100-011
15600-16010-71	364100-011
15600-20550-71	364100-050
15600-25010	364100-050
15600-39015	364100-009
15600-41010	364100-005
15600-44010	364100-030
15600-47011	364100-050
15600-49045	364100-050
15600-49046	364100-050
15600-61030	364100-005
15600-76003-71	364100-005
15600-76007-71	364100-050
15600-76009-71	364100-026
15600-76017-71	364100-050
15600-76018-71	364100-050
15601-13000-71	364100-037
15601-20550-71	364100-005
15601-20560-71	364100-005

OE Number	Crown Part Number
15601-22010	364100-009
15601-33010	364100-009
15601-33020	364100-009
15601-33021	364100-009
15601-41010	364100-017
15601-41830	364100-002
15601-42160-71	364100-006
15601-42830-71	364100-004
15601-42840	364100-002
15601-44010-83	364100-017
15601-44011-83	364100-017
15601-68101-71	364100-026
15601-76001-71	364100-009
15601-76002-71	364100-017
15601-76003-71	364100-017
15601-76005	364100-011
15601-76007-71	364100-011
15601-76008-71	364100-011
15601-76009-71	364100-075
15601-78001-71	364100-020
15601-87305-71	364100-013
15601-87310	364100-008
15601-96001	364100-050
15601-96101	364100-020
15601-U2120-71	364100-012
15601-U2120-F	364100-012
15611-31720-71	364100-003
17702-23470-71	364200-008
17702-30750-71	364200-018
17702-42500-71	364200-010
17703-23470-71	364200-008
17704-30710-71	364200-018
17712-96395-71	364200-002
17731-41830-71	364200-007
17741-13600-71	364200-008
17741-23600-71	364200-008
17741-30510-71	364200-026
17741-98333-71	364200-008
17741-F9860-71	364200-008
17741-U1100-71	364200-008
17741-U2100-71	364200-010
17741-U3330-71	364200-026
17742-32850-71	364200-008
17743-23600-71	364200-008
17743-98333-71	364200-008
17743-F9860-71	364200-008
17743-U1100-71	364200-008
17744-U2230-71	380030-154
17752-20540-71	364200-003
17791-11120-71	364200-002
17792-22000-71	364200-003
17801-15010-71	364100-009
17801-23000-71	364200-003
17801-23001-71	364200-003
17802-23000-71	364200-003
17802-23001-71	364200-003
17802-U2020-71	364200-003
17803-U2050-71	364200-003
17803-U2051-71	364200-003
17808-23800-71	364200-020
23303-30370-71	364200-003
23303-76002-71	380030-158
23323-42830-71	364300-009
25310-34950-71	380030-124
32150-40840-71	364100-017
32623-12620-71	364100-044
32623-20570-71	364100-017

OE Number	Crown Part Number
32670-12620-71	364400-001
32760-12620-71	364400-001
32901-31630-71	380030-164
40150-30370-71	364100-020
67502-13300-71	380030-129
67502-20540-71	380030-164
67502-23000-71	380030-163
67502-26600-71	380030-245
67502-U2230-71	380030-245
67532-42800-71	364100-018
78520-30200	364100-034
80915-76010-71	364100-030
80915-76012-71	364100-011
80915-76024-71	364100-030
89220-2005	364100-041
90080-91034	364100-041
90080-91058	364100-041
90915-03001	364100-041
90915-03002	364100-030
90915-03004	364100-041
90915-03005	364100-030
90915-10001	364100-041
90915-10002	364100-011
90915-10004	364100-011
90915-20001	364100-030
90915-20002	364100-076
90915-20003	364100-030
90915-20004	364100-001
90915-TA001	364100-041
90915-YZZA1	364100-011
90915-YZZA2	364100-041
90915-YZZB9	364100-017
90915-YZZD1	364100-017
90915-YZZD9	364100-041
90915-YZZF1	364100-011
90915-YZZF2	364100-041
C0120-00013	364100-041
VM52739001	364100-026
WIX/Air Refiner (WX)	
10FP	364950-001
13	364100-019
15	364100-020
22	364100-024
24	364100-019
24112	364900-002
25442	364200-028
26	364100-022
3119	364100-023
318P	364100-023
319P	364100-023
321P	364100-009
322P	364100-023
33033	364300-034
33091	364300-023
330P	364100-023
33118	364300-002
33128	364600-003
33166	364300-003
33192	364300-005
33340	364300-031
33352	364300-031
33352MP	364300-031
33356	364300-007
33357	364300-017
33357MP	364300-017
33358	364300-027
33358MP	364300-027

OE Number	Crown Part Number
33362	364300-031
33373	364300-001
33394	364300-015
333P	364100-023
33405	364300-024
33405MP	364300-024
33407	364300-004
33415	364300-024
33431	364300-024
33441	364300-024
33507	364300-009
33528	364300-007
33531	364300-008
33535	364300-032
33547	364300-032
335P	364100-044
33632	364300-032
33637	364300-032
33691	364300-018
33777	364300-027
342P	364100-023
345P	364100-023
347P	364100-008
350P	364100-023
42083	364250-003
42087	364200-049
42126	364200-018
42180	364200-025
42222	364200-003
42234	364200-046
42276	364200-002
42338	364200-018
42370	364200-009
42373	364200-048
42375	364200-048
42487	364200-043
42488	364200-043
42518	364200-024
42598	364700-001
42645	364200-007
42804	364250-004
42806	364200-008
42868	364200-036
46142	364200-004
46232	364200-006
46233	364200-016
46253	364700-002
46262	364200-001
46309	364200-022
46313	364200-027
46375	364200-064
46433	364200-045
46434	364200-013
46438	142110
46438FR	364200-014
46439	364200-014
46449	364200-047
46480	364200-020
46483	364200-037
46489	364200-010
46490	364200-015
46513	364200-011
46562	364200-026
46567	364200-024
46569	364200-031
46573	364200-019
46614	364100-043

⚠ WARNING: Cancer - www.P65Warnings.ca.gov

Note: More crosses available; contact your dealer.

WIX/Air Refiner Continued ▶

Filter Cross Reference

WX/Air Refiner Continued

OE Number	Crown Part Number
46652	364200-039
46671	364200-039
46672	380030-009
46836	364200-040
49020	364200-036
49021	364250-002
51010	364950-001
51036	364100-003
51037	364100-024
51040	364100-024
51040MP	364100-024
51041	364100-019
51042	364100-019
51050	364100-016
51060	364100-048
51064	364100-046
51068	364100-050
51068MP	364100-050
51069	364100-012
51083	364100-006
51084	364100-020
51085	364100-023
51085MP	364100-023
51088	364100-022
51182	364100-013
51191	364100-045
51194	364500-005
51208	364500-016
51243	364100-052
51243MP	364100-052
51261	364100-007
51268	364500-016
51268MP	364500-016
51288	364100-044
51307	364100-020
51311	364100-020
51312	364100-020
51316	364100-020
51319	364100-020
51334	364100-046
51334MP	364100-046
51335	364100-080
51338	364100-008
51339	364100-075
51342	364100-022
51344	364100-008
51345	364100-001
51348	364100-030
51348MP	364100-017
51356	364100-015
51362	364100-020
51372	364100-049
51372MP	364100-049
51376	364100-051
51380	364100-008
51381	364100-004
51391	364100-017
51393	364100-022
51394	364100-041
51395	364100-041
51396	364100-011
51422	364100-035
51452MP	364100-045
51453	364100-086
51455	364100-018
51460	364100-038
51515	364100-005

OE Number	Crown Part Number
51516	364100-039
51521	364100-037
51522	364100-084
51522MP	364100-084
51545	364100-034
51568	364100-008
51586	364500-026
51594	364500-018
51602	364100-032
51604	364500-015
51607	364500-015
51607MP	364500-015
51622	364100-034
51626	364100-047
51650	364100-035
51663	364100-036
51723	364500-011
51725	364100-033
51734	364100-091
51734MP	364100-091
51746	364100-029
51759	364100-029
51798	364100-051
51806	364100-026
51806MP	364100-026
51858	364500-009
51873	364100-089
533091	364300-023
533352	364300-031
542118	364200-046
542338	364200-018
546313	364200-027
546438	142110
546439	364200-014
546449	364200-047
546483	364200-037
546490	364200-015
546652	364200-039
546671	364200-039
546672	380030-009
551268	364500-016
551338	364100-008
551362	364100-020
551394	364100-041
551522	364100-084
551607	364500-015
551626	364100-047
557025	364500-012
557085	364100-044
557210	364100-068
57025	364500-012
57037	364100-078
57060	364100-031
57085	364100-044
57092	364100-071
57094	364100-014
57116	364500-012
57181	364400-001
57182	364100-083
57210	364100-068
57243	364100-028
57451	364500-010
57723	364500-013
59116	364100-065
59181	364300-015
A112	364200-027
CA415	364100-023

OE Number	Crown Part Number
CW10	364950-001
CW243MP	364100-052
CW452MP	364100-045
CW453MP	364100-086
CW84MP	364100-020
DT1246	364200-018
DT87	364200-049
PC307P	364100-020
PC311P	364100-020
PC312P	364100-020
PC316	364100-020
PC319P	364100-023
WA10316	364200-053
Yale (YT)	
014049960	364200-027
044052940	364200-027
063193600	364950-001
066457800	364200-002
066457900	364200-003
119005-35100	364100-008
119660-35150	364100-046
124085-35111	364100-008
129087-12510	142110
1327905	380103-911
138662100	364950-001
138662101	364950-001
140499600	364200-027
150011600	364100-050
150012700	364200-002
150012800	364200-003
150017200	364100-020
150017600	364100-006
150023100	364200-002
150127002	364600-004
190886001	364500-003
220000637	364500-009
220001862	364100-018
220002418	364100-007
220002486	074105
220002487	364200-004
220003608	364200-041
220004261	364100-001
220004522	364200-016
220005321	364100-001
220006163	364300-031
220006165	364100-079
220006498	364100-037
220007093	364100-001
220007906	364300-031
220007907	364200-046
220007910	364100-034
220007911	364500-016
220007914	364200-046
220010432	364200-027
220016046	364100-002
220016442	364100-022
220017036	364200-010
220018074	364100-014
220018224	364300-027
220018365	364200-020
220018642	364200-023
220019061	364100-008
220020159	364200-041
220020426	074105
220020474	074105
220021422	364100-004
220021672	364100-006

OE Number	Crown Part Number
220021873	364100-012
220021874	364100-034
220021883	364200-033
220022271	077145
220023301	364200-041
220023404	364500-015
220023405	364300-017
220023427	364100-002
220023954	364200-011
220024174	364100-014
220024667	364100-009
220025201	364100-037
220025232	364200-003
220026447	364300-015
220027050	364100-018
220028173	364200-014
220028667	364200-002
220031787	364100-017
220036196	364200-008
220036199	364600-003
220036241	364400-001
220036509	364100-011
220037602	364200-010
220040677	364100-017
220042480	364500-015
220042484	364300-017
220042965	364200-002
220043605	364100-012
220043748	364500-012
220044119	364100-002
220044765	364200-015
220049713	364300-032
220049758	364500-012
220052149	364100-006
220052452	364100-005
220054022	364600-003
220054026	364200-001
220054027	364300-015
220054030	364200-002
220054033	364200-003
220070304	364600-003
220070365	364500-011
220070367	364200-006
220070371	077145
220070380	364100-044
220070490	364500-012
220070555	364100-030
220070633	364200-001
220071699	364200-007
220072541	364100-003
220073924	364400-009
220074151	364500-009
220075007	364300-003
220075012	364100-016
220075013	364100-020
220075018	364100-026
220075022	364100-038
220075033	364200-003
220075043	364200-002
220075112	364100-020
220075116	077145
220079879	364200-017
220088276	364100-044
220102404	364200-010
249999000	364200-002
249999001	364100-006
249999002	364100-016

SERVICE SUPPLIES

▲ WARNING: Cancer - www.P65Warnings.ca.gov

Note: More crosses available; contact your dealer.

Yale Continued ▶

Filter Cross Reference

Yale Continued

OE Number	Crown Part Number
249999003	364200-003
249999004	364100-001
249999005	364100-004
249999006	364100-013
249999007	364100-050
249999008	364100-026
249999019	364100-026
249999021	364100-007
249999022	364100-026
249999023	077145
249999024	364500-012
249999025	364200-001
249999026	364100-009
249999027	364100-038
249999028	364100-015
249999030	364100-006
249999031	364200-041
249999032	364200-010
249999033	364200-013
249999034	364200-009
249999035	364200-006
249999037	364300-015
249999038	364100-002
249999039	364200-011
249999040	364100-037
3122275	364200-023
330035194	364200-027
330035556	364100-032
440052940	364200-027
440054069	364100-026
440054600	364100-038
44052940	364200-027
461015223	364100-032
500138800	364950-001
500139800	364950-001
502903501	077145
504025100	364200-018
504240863	364200-003
504297790	364100-012
504449744	074105
505676800	364200-018
505960559	364100-006
505966578	364100-020
505973580	380030-128

OE Number	Crown Part Number
506973401	364200-018
507640800	364200-018
513498801	364100-034
515133806	364100-038
515133851	364300-003
515133856	364100-038
5151413	364100-005
515141300	364100-005
515303801	364100-035
5158648	364200-003
515864800	364200-003
515865800	364200-002
515935800	364100-016
516042852	364300-003
517584860	364100-038
5194548	364100-050
519454800	364100-050
520045030	364200-015
524136754	380103-911
524148312	364500-019
580002784	364200-018
580004421	364300-001
580007144	364100-034
580008852	364100-026
580010991	380030-123
580031871	364500-015
580042635	364300-023
580048839	380030-064
580052153	380030-162
580056944	380030-068
580058663	364500-015
580058807	364500-015
580069337	364250-001
580074341	364100-083
580088196	364250-002
582002947	380030-162
582005334	380030-162
582034868	364100-092
582036738	364100-081
66457800	364200-002
751287402	364100-035
800058909	159792-001
800071711	364100-034
800130449	380030-162

OE Number	Crown Part Number
800135439	370511
800142220	364250-002
900001224	380030-047
900006282	364100-003
900291828	364100-006
900506400	364100-034
900506401	364100-034
900533802	364100-008
900538802	364100-008
900546802	364200-003
900770802	364100-032
900907800-E	364600-003
900907804	364600-003
900907810	364600-003
900907811	364600-003
901030815	364100-008
901091803	364200-003
901277817	364200-002
901281813	364200-065
901301815	364100-008
901397803	364200-003
901515400	364200-002
901517400	364100-006
901544400	364500-003
901870801	364200-003
901992850	364200-002
902166802	142110
902225300	364200-002
902255802	364200-010
902426801	364200-026
902489801	364200-042
904788100	364100-020
905332600	364100-036
905332601	364100-036
907160600	364100-036
907160601	364100-036
907172400	364100-020
910361400	364100-020
910544400	364500-003
910545401	380102-349
917380400	364500-010
927788400	364100-020
1018296	364700-004

WARNING: Cancer - www.P65Warnings.ca.gov

Note: More crosses available; contact your dealer.

Section 2

Safety Equipment

Contents

Seat Belts	2.02
Mirrors	2.02
Harnesses	2.03
Lanyards/Accessories	2.05
Maintenance Safety Items	2.06
Ergonomic Products	2.07
Eye/Hearing/Breathing/Face Protection	2.07
Shoe Covers	2.11
Miscellaneous	2.11
Safety Apparel	2.12
Hard Hats	2.14
Cooling Products	2.14
Safety Related Accessories	2.15
Spill Cleanup Products	2.17
First Aid Kits	2.18

New Items:

Ear Muffs for Hard Hat - p. 2.09

Circuit Breaker Lockout Single - p. 2.15

Note: 1910.178(q)(5) (1998) of the Occupational Safety and Health Act (OSHA) requires that "All parts of any such industrial truck requiring replacement shall be replaced only by parts equivalent as to safety with those used in the original design."

The installation onto a lift truck of non-certified electronic components may invalidate a truck's UL EE or LPS listing and could pose a safety risk. Customers with UL-listed lift trucks are solely responsible for ensuring compliance with UL for field modifications. The selection of non-OEM parts is made solely by the customer with the awareness that OEM parts are available. Crown Equipment Corporation is unaware of what testing and/or certification, if any, the non-OEM parts have undergone and disclaims all warranties and representations regarding any non-OEM part.

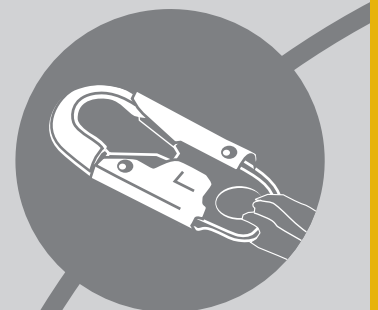

Seat Belts

Seat Belts

Part Number Orange	Part Number Black	Part Number w/ Interlock Switch	Type	Retractor Style	Belt Width	Belt Length	Dim. A	Dim. B	Includes U- shaped Bracket
122003-002	122003		Retractable, Anti-cinch	"Y"	2"	50"	4"	11.50"	X
122016-002	122016		Retractable, Anti-cinch	"Y"	2"	50"	4"	9.60"	
132257-002	132257		Retractable, Anti-cinch	"Z"	2"	54"	8.50"	10.50"	X
132252-002	132252	132252-003	Retractable, Anti-cinch	"Z"	2"	54"	8.50"	10.50"	
163519-002	163519-001	163519-003	Retractable, Anti-cinch	"X"	2"	51"	5.50"	10.50"	
300000	NA		Retractable	"Y"	2"	50"	4"	11.50"	X
163450-002	NA		Retractable, Anti-cinch	"X"	2"	51"	5.5"	9.7"	

⚠ WARNING: Cancer and reproductive harm - www.P65Warnings.ca.gov

Note: Mounting hardware included. Seat belts meet requirements of SAE J386 and FMVSS 302.

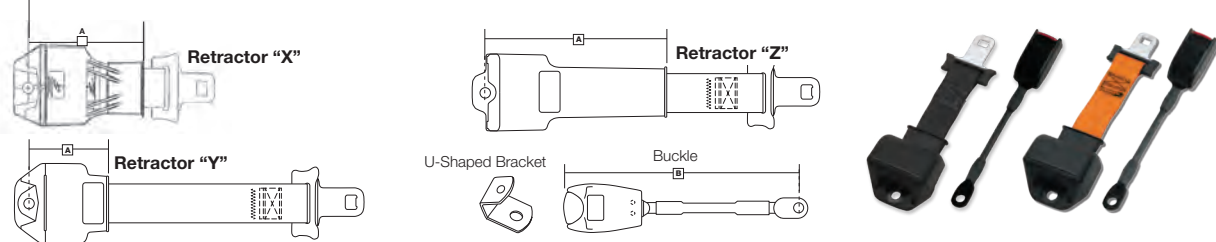

Mirrors

Part Number	Dimensions W x L (in)	Description
111481	4.44 x 5.75	Bolts on with 1/4"-20 UNC nut
094723	5.65 x 8.65	Bolts on with 1/4"-20 UNC nut
137670	7.32 x 12.52	Mounts onto .55" - .79" (14-20 mm) diameter rod
105035	6.00 x 23.00	Flat mirror, no mounting
105036	6.00 x 23.00	Includes mirror (P.N. 105035) and machined cover mount.
148613	4.50 x 8.00	Plastic mirror, bolts on with 3/8" UNC nut
151007	6.37 diameter	Round acrylic lens

⚠ WARNING: Cancer and reproductive harm - www.P65Warnings.ca.gov



Part Number - 380030-006

Mirror

4" x 7.875"

▼ OEM Reference

TY 58710-20540-71



Part Number - 380030-007

Mirror

3.875" x 6.25"

▼ OEM Reference

HM 7395

NI 96303-11H00



Part Number - 380030-044

Mirror

4.625" x 8"

▼ OEM Reference

HM 7390

NI 96303-6G000

KM 4966092

TY 58720-23320-71

KO 3EB-55-13571

TY 58720-26600-71



300130-001



300130-002

Anti-Blind Spot Dome Mirrors

These plastic mirrors give a complete 180° view, allowing the operator to give a quick safety check before traveling in reverse. Installs on any lift truck in seconds with either two-sided tape or a magnet.

Part Number - 300130-001

3M two-sided tape;
8.5" x 6.25" x 3"

Part Number - 300130-002

Magnet; 8.25" x 7.5" x 3"



Part Number - 380030-168

Mirror

4.625" x 8"

▼ OEM Reference

TY 58720-23000-71



Part Number - 305001

Mirror

5.5" x 7.5"

Hardware: 1/4" - 20 x 7/16" L

⚠ WARNING: Cancer - www.P65Warnings.ca.gov

Personal Fall Protection System Configurations (lbs.)

Fall Protection / Prevention Device	Operator Weight (lbs.)			Contact Truck Manufacturer
	<311 ¹	311-400 ¹	>400 ¹	
Full Body Harness	X	X	X	
Energy Absorber - max total length (6ft.)	X			
Self Retracting Lanyard		X	X ²	
Maximum Arresting Force Permitted (lbs)	1800	1800	1800	

- 1) Truck Capacity shall be reduced by the operator(s) weight in excess of 220 lbs.
 2) Self Retracting Lanyard - shall be rated for the operator's weight. Contact Truck Manufacturer.

Note: ANSI standards B56.1 (4.17). Standards effective Feb. 23, 2013.



Full Body Harness with Mating Buckle

Part Number	Size
300001-004	X-Small
300001-001	Small/Medium
300001-002	Large/X-Large
300001-003	XX-Large

- Lightweight nylon webbing
- Permits unrestricted movement
- Lightweight and durable
- Forged-steel sliding back D-ring
- Mating buckles on legs and shoulder straps



Full Body Harness with Tongue Buckle

Part Number	Size
152899-001	Small/Medium
152899-002	Universal
152899-003	XX-Large

- Lightweight stretchable leg and shoulder webbing
- Tongue buckle leg strap
- Mating chest strap buckle
- Detachable shoulder pads
- Steel back D-ring



Full Body Harness with Tongue Buckle

Part Number	Size
300002-001	Small/Medium
300002-002	Large/X-Large
300002-003	XX-Large
300002-004	XXX-Large

- Conventional nylon webbing
- Friction buckles on chest and shoulder straps
- Tongue buckle leg straps
- Forged steel sliding back D-ring
- Permits unrestricted movement

Harness Size Reference Chart

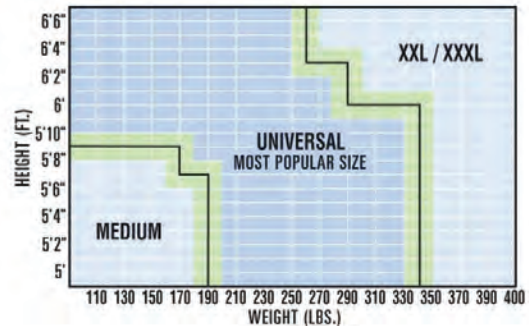

Part Number	Capacity (lbs.)	Sliding Back D-Ring	Side D-Rings	Shoulder Strap Buckles*	Leg Strap Buckles*	Chest Strap Buckle*	Sub-Pelvic Strap	Pull-Free Lanyard Rings	Stretchable Webbing	Manufacturer	Shoulder & Leg Padding Removable
300001-XXX	400	Yes	No	M	M	M	Yes	Yes	No	Titan	No
300002-XXX	400	Yes	No	M	T	M	Yes	Yes	No	Titan	No
152899-XXX	400	Yes	No	F	T	M	Yes	Yes	Yes	Miller	No

*Key: F-Friction; M-Mating; T-Tongue



1. Sliding Back D-Ring; 2. Side D-Ring; 3. Mating Buckle; 4. Friction Buckle; 5. Tongue Buckle

Fall Protection - Harnesses



AirCore Full Body Harness with Aluminum Hardware

- Corrosion resistant aluminum hardware
- Breathable, open-core padding technology
- Stretchable webbing provides flexibility and comfort
- Cam buckles on the shoulder straps for easy adjustments
- Universal (Large/X-Large)

Part Number	Side D-Rings	Chest Strap Buckle	Leg Strap Buckles	Lumbar Pad	Removeable Belt
300031-050	No	Quick-Connect	Tongue	No	No
300031-051	No	Quick-Connect	Quick-Connect	No	No
300031-052	Yes	Quick-Connect	Tongue	No	No
300031-053	Yes	Quick-Connect	Quick-Connect	No	No
300031-054	Yes	Quick-Connect	Tongue	Yes	Yes



AirCore Full Body Harness with Steel Hardware

- Breathable, open-core padding technology
- Stretchable webbing provides flexibility and comfort
- Cam buckles on the shoulder straps for easy adjustments
- Universal (Large/X-Large)

Part Number	Side D-Rings	Chest Strap Buckle	Leg Strap Buckles	Lumbar Pad	Removeable Belt
300031-010	No	Quick-Connect	Quick-Connect	No	No
300031-011	No	Quick-Connect	Tongue	No	No
300031-012	Yes	Quick-Connect	Quick-Connect	No	No
300031-013	Yes	Quick-Connect	Tongue	No	No
300031-014	Yes	Quick-Connect	Quick-Connect	Yes	Yes
300031-015	Yes	Quick-Connect	Tongue	Yes	Yes
300031-016	No	Mating Buckle	Tongue	No	No
300031-017	Yes	Mating Buckle	Tongue	Yes	Yes



Harness with Trauma Strap Universal/Large

Part Number 353601

No-tangle design. Includes trauma strap. Stand-up back D-ring. Tongue buckle leg straps. Repel™ webbing. Built-in lanyard keepers. Revolver™ vertical torso adjusters. Impact Indicator. Protected labels, equipped with i-Safe™.



ExoFit x200 Safety Harness

Part Number Size

300007-001	S
300007-002	M
300007-003	L
300007-004	XL
300007-005	XXL

- Dual-locking quick connect buckles
- Automatic stand-up dorsal D-ring
- Personal SRL adapter
- Anti-slide dorsal D-ring pad
- Revolving torso adjusters
- Integrated suspension trauma relief straps



Trauma Strap

Part Number 353603

Suspension trauma safety strap. Allows user to stand in harness after a fall. Attaches to almost any harness. Fast and easy installation. Extremely compact and lightweight design. Simple and fast zipper style deployment. Continuous loop design. In-field re-settable design.

Harness Size Reference Chart

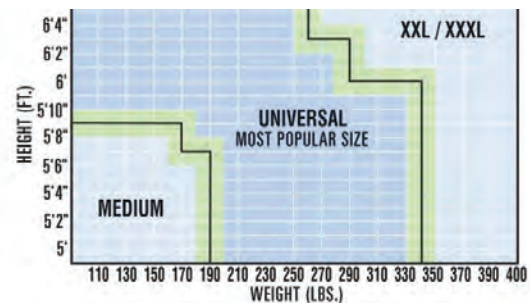

Fall Protection - Lanyards



170134

Smart Lanyard Kits

Fall protection system provides audible and visual alert of worker tie off status. Detects associate's presence as they move on and off picker platform. Works with metallic OSHA-rated dorsal D-Rings.

Part Number	Description	Length (ft.)	Weight Capacity (lbs.)
170131	Smart Lanyard Kit 1.5	11	310
172088	Smart Lanyard Kit 2.0	11	310

Kit Components

Part Number	Description	Smart Lanyard Kit 1.5	Smart Lanyard Kit 2.0
170134	Connected Order Picker SRL	X	X
170135	CAB Mount Bracket for SRL	X	X
170136	Sensor Alert Box	X	
170137	Connected LED Lights	X	X
170138	Alert Box Power Cable	X	
172222	Alert Box and Power Cable		X
172223	Tie-off Cable		X



Lanyard Self-Retracting

Part Number	Length (ft)	Weight Capacity (lb)
153557	9	420

Quick-activating, high strength stainless steel breaking system. Offers great mobility with high-impact nylon housing, abrasion-resistant webbing and user friendly labels. Integral swivel reduces lifeline twisting.



Lanyard Self-Retracting

Part Number	Length (ft)	Weight Capacity (lb)	Color
353600	8	400	Red

Extremely compact and lightweight. High-impact nylon housing and abrasion-resistant webbing. Snap hook w/aluminum body and steel gate. Stainless steel ball bearing swivel.



Lanyard Energy-Absorbing

Part Number	Length (ft)	Weight Capacity (lb)
129935-001	6	310

Orange - locking snap hooks on each end.



Retractable Lanyard U-Bolt Swivel

Part Number	Length (ft)	Weight Capacity (lb)
H53622-531	6	420

Dyneema® fiber and polyester web lifeline. Swiveling self-locking snap hook on lifeline. Extremely compact, lightweight design. Tough and impact resistant thermoplastic housing. Swiveling anchorage loop. Quick activating speed sensing brake system. High capacity external energy absorber and impact indicator. i-Safe™ equipped.



Turbo Lite - Personal Fall Limiter

Part Number	Length (ft)	Weight Capacity (lb)
300028	6	420

Extremely compact and lightweight. High-impact nylon housing and abrasion-resistant webbing provide long service life. Integral swivel prevents lifeline from twisting. Unit Connectors: Steel Twist-Lock Carabiner and Steel Locking Snap Hook.

Fall Protection - Accessories



Carabiners Turn Open Lock

Part Number	Gate
300064	3/4"
300006-001	1"

Maintenance Safety Items ^(^Not for operator use on lift truck)



Self-Retracting Lifeline[^]

Part Number	Length (ft)	Weight Capacity (lb)
300067	11	310
300010	20	310
300068	50	310
300069	66	310
300070	85	310

- Industry's lightest and most compact SRL.
- Unique speed-sensing brake reduces clearance requirements and limits fall arrest forces to 900 lbs or less.

[^]Note: Not for operator use on lift truck.



Lanyard Positioning[^]

Part Number	Length (ft)	Weight Capacity (lb)
300063	6	310

1" wide web built in wear indicator informs user when to replace self-locking snap hooks at both ends.

[^]Note: Not for operator use on lift truck.



3' Tie-off Adaptor[^]

Part Number	Length (ft)	Weight Capacity (lb)
300059	3	310

- 1 3/4" polyester strength member, 5000 lb minimum tensile strength.
- 3" wide polyester wear pad for added abrasion resistance.

[^]Note: Not for operator use on lift truck.



Tag Line[^]

Part Number	Length (ft)
300060	25

3/8" polypropylene rope with o-ring at end used to tie to end of self retracting lifelines to bring end down to the user.

[^]Note: Not for operator use on lift truck.



Storage Bag[^]

Part Number	Size (in)
300066	24W x 12H x 12D

Used to store and carry harnesses, lanyards, tag lines, etc.

[^]Note: Not for operator use on lift truck.

WARNING: Cancer and reproductive harm - www.P65Warnings.ca.gov



Carabiners Turn Open Lock

Part Number	Gate
300064	3/4"
300006-001	1"

▲ ExoFit XP Harness Accessories

Storage Pouch

Part Number	Description
300137	Belt loops on back of pouch for easy attachment to your belt and harness. Velcro closure and built-in D-rings to secure items. 18 oz. duck canvas with inner lining. Size: 7.5" x 11".



300137

WARNING: Cancer and reproductive harm - www.P65Warnings.ca.gov

Cell Phone Pouch

Part Number	Description
300062	Attaches to harness



300062



Ratchet Strap[^]

Part Number	Length (ft)
300136	6

- 1" wide strap
- Work load limit 500 lbs.
- Breaking strength 1,500 lbs.

[^]Note: Not for operator use on lift truck.

Ergonomic Products

Crown Branded Kneeling Pad *

Part Number	Description	Sales Unit
365472	1" thick; 7.5" x 15.5"	1/each

Lightweight EVA foam cushioning.
Built-in handle for easy storage.
Helps reduce knee and back strain.



Kneeling Pad *

Part Number	Description	Sales Unit
365472-006	1" thick; 14" x 21"	6/case

Made of Nitrile blend resilient foam.
Non-conductive and minimal water absorption.
Lightweight with built-in handle for easy storage.



Knee Pads*

Part Number	Sales Unit
365500	1 pair

Smooth hard cap attached with nickel plated grommets easily slides over various surfaces. Durable 600D Polyester fabric. 15mm EVA foam padding. Anti-bacterial treatment. Injection Plastic button/clip strap connectors provide easy adjustment and secure fit. Black. One size fits most.



Back Support *

Part Number	Sales Unit	Size
365501-006	1 ea	Small
365501-001	1 ea	Medium
365501-002	1 ea	Large
365501-003	1 ea	X-Large
365501-004	1 ea	2XL
365501-005	1 ea	3XL
365501-007	1 ea	4XL
365501-008	1 ea	5XL

Adjustable suspenders with smooth glide adjustable clips. Support elastic suspenders are extra wide for durability. Abdominal support panels are tapered for better fit. Black.



Eye Protection

Continued >

Safety Glasses*

Part Number	Sales Unit
365285-012	Case of 12



Crown logo branded - printed on right lens. Soft integrated nose piece. Lightweight and 9.75 base curve lens provides excellent side protection. Soft dual injected rubber temple tips provide non-slip comfort. Scratch resistant polycarbonate lens provides 99% UVA/B/C protection. Conforms with ANSI Z87.1.



Safety Glasses*

Part Number	Sales Unit
365254-012	Case of 12



OTG basic eyewear protection for visitors. Economical. Clear frame, clear lens, fits over glasses. ANSI approved Z87.1.

Safety Glasses*

Part Number	Sales Unit
365252-012	Case of 12



Wraparound Hi-Vis Green design for maximum field of vision. Padded nose bridge. Adjustable temple arm. Hi-Vis Green retainer cord. Conforms with ANSI Z87.1.

OTG Safety Glasses*

Part Number	Sales Unit
365286-012	Case of 12



Crown logo - printed on right side shield. One piece lightweight safety glass lens. Adjustable temples and extended brow guard. Over glasses design. Polycarbonate impact resistant lens with 99.9% UVA/UVB protection. Conforms with ANSI Z87.1 + standards.



Safety Glasses*

Part Number	Description	Sales Unit
365485-012	Black frame; Amber lens	Case of 12



Soft rubber temples with flared ends. Neck cord included. Coated protective lens - provides 99.9% UVA/UVB protection. Conforms with ANSI Z87.1+

Safety Glasses*

Part Number	Sales Unit
365250-012	Case of 12



Economical protection. Full coverage. Frost color frame, clear lens. Wraparound style, lightweight. Conforms with ANSI Z87.1.

Safety Glasses*

Part Number	Sales Unit
365251-012	Case of 12



Soft padding on temple arm tip and padded nose bridge. Black frame, clear lens. Adjustable temple arm. Wraparound style, durable frame. Conforms with ANSI Z87.1.

Safety Glasses

Part Number	Description
363200-008	Safety Glasses - Amber Lens with Amber Temples
363200-010	Safety Glasses - Amber Lens with Black Temples



*Available only to customers in USA

Eye Protection



Premium Anti-fog Safety Glasses*

Part Number	Sales Unit
365287-012	Case of 12

H2X anti-fog protection from fogging in humid environments. Scratch resistant. Dielectric. Rubber temple tips and nose piece. Single wraparound lens. Conforms with ANSI Z87.1+, CAN/CSA Z94.3 standards.



Standard Anti-fog Safety Glasses

Part Number	Sales Unit
365279-012	Case of 12

Anti-fog coating for protection from fogging in humid environments. Scratch resistant. Earplug retaining technology. Hollowed out, lightweight frame for maximum air flow. Byaonet temple for greater comfort. Conforms with ANSI Z87, CAN/CSA Z94.3 standards.



Goggles*

Part Number	Sales Unit
365253-012	Case of 12

For complete eye protection where splash or heavy particles are in the air. Full face flange allows for comfort while the polycarbonate lens give full protection. With Anti-Fog lenses and indirect ventilation. Conforms with ANSI Z87 safety standard.



+1.5 Reading Lens*

Part Number	Sales Unit
365256	Single

Strategic placement of lens insert is out of user's direct line of vision. 100% Polycarbonate scratch resistant lenses. Nose buds secure the glass & prevent slipping, adjustable temple arm. Provides 99% protection from harmful UL UV-A & UV-B rays. Exceeds ANSI Z87.1 high impact requirements & CE EN166 certified.



I-Force Goggles*

Part Number	Sales Unit
365257	Single

Sporty, lightweight design. Quick release interchangeable temples & elastic strap. Anti-fog, clear lens. Exceeds ANSI/ISEA Z87.1 standards.



Pre-Moistened Towelettes*

Part Number	Sales Unit
365255	10 boxes/case

5" x 8", 100 to a box. NOT for use on coated lenses. For glasses and computer screens. Individual packages for convenience and portability.

Eye Wash Products



16 Gallon Eye Wash Station*

Part Number	Sales Unit
365466	1 kit

Size: 20.5" length, 18" width, 20.5" height. 15 minute flow, required by ANSI Z358.1-2009. Includes steel wall bracket, 2 oz. sterile water solution, and test log and drainage hose. Drain and refill every 4 months with 2 oz. solution, part number 365474.



Replacement Bottle of Eye Wash*

Part Number	Sales Unit
365469-001	One 16 oz. bottle

Sterile eye wash. Can be used alone or with 365468 eyewash station.



Water Additive*

Part Number	Sales Unit
365474	8 oz. bottle/12 case

Add to water for 16 gallon eye wash station to eliminate contamination from stagnant water. 8 oz. per 16 gallon refill.



Eye Wash Station*

Part Number	Sales Unit
365468	1 kit

Two bottle wall-mounted eye wash station. Includes two 16 oz bottles of sterile eye wash. Easily mounts to any wall.

*Available only to customers in USA

Hearing Protection



Ear Plugs*

Part Number	Sales Unit
365280-200	200 pairs/box

NRR 33. Officially licensed ear plugs of NASCAR®. Tapered for easy insertion in any ear canal. Different colors in every package. Individually wrapped. 1 pair per bag.



Ear Muffs*

Part Number	Sales Unit
365282	Single

Low profile design. Soft foam ear cups. Adjustable to fit all sizes. Fold-away padded headband. Meets ANSI S3.19 requirements, CE EN 352-2:2002 certification, NRR 34.

▲ **WARNING:** Cancer and reproductive harm - www.P65Warnings.ca.gov



365493-250-02

Moldex Sparkplugs® Plugstation® Dispenser*

Part Number	Description	Sales Unit
365493-250-02	Sparkplugs®	250 pairs/station 2/case
365494-500-04	Sparkplugs®	500 pairs/station 4/case

NRR 33. Chute delivers plug directly into hand. Each dispenser is completely sealed. Fully disposable when empty and recyclable.



365494-500-04



Ear Muffs for Hard Hat*

Part Number	Sales Unit
365283	Pair

Cap mounted earmuff; fits slotted cap style hard hats. Easily accessible while working, flip down over ears to use or flip up when not in use. Ear cup is high impact polystyrene; ear cushion is PVC with foam pad. Gray. Dielectric. Meets ANSI S3.19-1974.



Moldex Glide™ Reusable Ear Plugs*

Part Number	Sales Unit
365495-100	50/box

NRR 33. Unique multi-curved stem rotates for a custom fit. Large handle on curved stem for easy insertion and removal. Cord can be attached at any desired length. Can be washed and reused. Green.



Ear Plugs*

Part Number	Sales Unit
365281-100	100/box

NRR 33. Officially licensed ear plugs of NASCAR®. Tapered for easy insertion in any ear canal. Different colors in every package. Individually wrapped. 1 pair per bag. With cord.



Electronic Ear Muff - Sport

Part Number	Sales Unit
300148	Single

NRR 22 dB. Canada Class B. Built-in directional microphones amplify range commands and other ambient sounds to a safe 82dB. Impact Sport actively listens and automatically compresses amplification when ambient impact sound reaches 82dB, and passively blocks out noise at 22dB. Amplifies low-level sound up to 4 times. Low energy-consuming 4-hour automatic shut-off. Connects to iPod, MP3 and other devices. Patented Air-Flow Control Technology. Camouflage. Soft headband. Folds for convenient storage. Protection against harmful noise.



Electronic Ear Muff - Pro

Part Number	Sales Unit
300149	Single

NRR 30 dB. Canada Class A(L). Strategically placed directional stereo microphones to amplify ambient sounds, including alarms/warning signals, and conversations while suppressing (not muting) loud, impact noises down to a safe level of 82dB. Sound amplification allows wearers to hear important communication - alarms/warning signals, co-workers' voices. Quick-Click height adjustment remains fixed during wear. More comfortable padded headband. All-in-one up and down, on/off and volume control. Snap-in ear cushions make replacement quick. Features 3.5mm audio jack and cable for connection to personal listening devices.



Ear Plugs - Multiple Use

Part Number	Sales Unit
300152-100	100 pairs/box

Soft no roll-down foam with flexible stem and dimpled tip reduces hygiene concerns and collapses to be easily inserted into the ear. The ergonomically contoured paddle fits naturally between the finger and thumb, even while wearing work gloves. Reusable, uncorded. Convenient carrying case. Noise reduction rating of 28; orange; one size fits most.

*Available only to customers in USA

Breathing Protection



Moldex 9000 Reusable Full-Face Respirator*

Part Number	Sales Unit
365274	Single

Provides lung and face protection. Lightweight. Strap buckles are securely molded to face piece for rugged use. Coated lens for scratch resistance. Size: Large. NIOSH approved.



KN95 Mask*

Part Number	Sales Unit
365295-050	50/box

Filters up to 95% of particles with 5-layer construction. Non-medical, ear loop style with adjustable nose clip. Fits comfortably to the face and provides respiratory protection against particles. Regulated by the Chinese government under GB2626-2006.



Protective Sheets for Face Shield*

Part Number	Sales Unit
365274-001	15 sheets/box

For use on full-face respirator (P.N. 365274) to protect face piece.



Disposable Mask

Part Number	Sales Unit
365294	50/box

Unique 4-fold design forms a better cone shape to provide maximum coverage. 3-ply construction; ear loop style. Masks are 100% latex and fiber glass free. Inner layer is ultra soft and comfortable on the skin. Metal free plastic nose bridge conforms to wearer's face for a comfortable fit. Meets ASTM F2100-11 requirements as Performance Level 2 Barrier medical face mask. Color blue.



Moldex N95 Particulate Pre-Filter*

Part Number	Sales Unit
365275	5 pair/pack

Use with vapor cartridge or stand alone. NIOSH certified.



Respirator Mask w/Exhale Valve*

Part Number	Sales Unit
365271-010-01	10/box - 1 box

95% effective against particulate aerosols free of oils. Adjustable metal nose piece and inner foam provide a custom seal. Yellow color-coded straps. With exhale valve. Meets NIOSH 24 CFR Part 84 Standards.



Reusable Mask

Part Number	Sales Unit
365297-005	5/pack

3-ply, 100% machine washable cotton jersey; 100% cotton fabric touching skin; three evenly spaced pleats on each side. 3.5 in height at side, 5 in. height at center front, 7 in width. Comfortable elastic ear loops help hold the mask in place. Color black.



Moldex® 2300 N95 Particulate Respirator*

Part Number	Sales Unit
365277-010-01	10/box

Dura-Mesh shell for durability. Protects against fine, dry particles. Softspun inner liner for comfort; molded nose bridge. Blue/white. Size: medium/large. NIOSH approved. With exhale valve.



Moldex 7000 Reusable Half-Mask Respirator

Part Number	Sales Unit	
365273	Large	Single
365273-001	Medium	Single

Totally adjustable. Lightweight. Fits under welding helmets & with safety glasses. NIOSH approved. Includes face piece, 2 organic vapor cartridges, retainer and 2 prefilters.



Nuisance Mask*

Part Number	Sales Unit
365272-050-01	50/box - 1 box

For dirt, dust and nuisance cleaning. Single strap and metal nose piece. Not NIOSH approved. 50/box.



Organic Vapor Cartridges*

Part Number	Sales Unit
365276	1 pair/pack

Protection against organic vapors. Use with half-mask respirator (P.N. 365273) or full-face respirator (P.N. 365274).



Particulate Respirator*

Part Number	Sales Unit
365289-020-01	20/box

N95 approved filtering particulate respirator. Adjustable nose clip reduces potential for eyewear fogging and helps ensure a better seal and fit. Two straps help provide a secure fit.



Respirator Mask*

Part Number	Sales Unit
365270-020-01	20/box - 1 box

95% effective against particulate aerosols free of oils. Adjustable metal nose piece and inner foam provide a custom seal. Yellow color-coded straps. Meets NIOSH 24 CFR Part 84 Standards.



Disposable Respirator*

Part Number	Sales Unit	
365288-001	Medium	Single
365288-002	Large	Single

Organic Vapor and P95 respiratory protection. Maintenance free; OV cartridges permanently attached and individually packed. Includes a bonus hygiene guard and shape retainer insert. Applications include paint spray applications, including oil based paints.

*Available only to customers in USA

Face Protection



Face Mask*

Part Number	Sales Unit
365258	Single

Full face protection, fits over prescription glasses. Removable shield. Exceeds ANSI Z87.1 high-impact requirements. CE EN166 certified. Exceeds CAN/CSA Z94.3-07 standards.



Universal Hard Hat Adapter*

Part Number	Sales Unit
365262	Single

For use with face shields.



Polyethylene Face Shield (only)*

Part Number	Sales Unit
365263	Single

8" x 15" x .040" thick. Meets ANSI Z87.1 requirements; CSA Z94.1-05. Headgear is separate.



Disposable Tear-Off Visor*

Part Number	Sales Unit
365259	6/pack

Full face protection.



Headgear for Face Shield*

Part Number	Sales Unit
365261	Single

Constructed from durable nylon. Universal pegs will accommodate a wide variety of face shields. Ratchet style adjustment for easy fit. Pivoting action allows user to lift face shield while wearing.



Polycarbonate Face Shield (only)*

Part Number	Sales Unit
365264	Single

8" x 15" x .040" thick. Meets ANSI Z87.1 requirements; CSA Z94.1-05. Headgear is separate.



Face Shield

Part Number	Sales Unit
323016	Single

3M Ratchet Headgear with Faceshield. Features polycarbonate construction to provide high clarity. Ideal for heavy-duty impact and heat-resistance applications.

Shoe Covers



Premium Shoe Covers*

Part Number	Description
365301-240	60 pair/box; 2 boxes/case. Polypropylene coated with polyethylene for extreme durability. Non-slip texture offers support and grip on any floor surface. Wide elastic opening. X-Large size. Non-linting; latex and silicone free. Durable dispensing box.



Shoe Covers*

Part Number	Description
365301-300	Non-skid bottom. Polypropylene. Elastic around ankles. X-Large. 150 pairs.

*Available only to customers in USA

Miscellaneous



One Source Lanyard

Part Number	Description
352001	17" smooth nylon lanyard comes with 3 attachments: O-ring, metal swivel hook, and accessory loop.



Breakaway Safety Vests

Size	Crown Branded Part Number
Small	365314-000-01-C
Medium	365314-001-01-C
Large	365314-002-01-C
X-Large	365314-003-01-C
2XL	365314-004-01-C
3XL	365314-005-01-C
4XL	365314-006-01-C
5XL	365314-007-01-C



100% polyester mesh, hi-vis green. Sold individually. 5 point breakaway, shoulders, sides and front closure. Closure: velcro. 2" silver tape reflective material - 1 horizontal stripe. Pockets: 1 lower right inside, 1 upper left outside. 3rd party certified, meets ANSI/ISEA 107-2015, Class 2 Type R standards.



Zippered Safety Vests



Size	Hi-Vis Orange Part Number	Hi-Vis Green Part Number
Medium	365317-001-01	365319-001-01
Large	365317-002-01	365319-002-01
X-Large	365317-003-01	365319-003-01
2XL	365317-004-01	365319-004-01
3XL	365317-005-01	365319-005-01
4XL	365317-006-01	365319-006-01
5XL	365317-007-01	365319-007-01

Economy Class 2 Safety Vest with Two-Tone Trim - Zipper. 100% Polyester Mesh. Zipper Closure. Crown Embroidered Logo. Pockets: 1 Upper Left Front, 1 Lower Right Inside, Zipper closure. 2" silver reflective material. 25 wash max. Meets ANSI/ISEA 107-2015 standards, Class 2 Type R standards.



Breakaway Safety Vests*

Size	Orange Mesh Part Number	Orange Solid Part Number
Small	365312-000-01	365313-000-01
Medium	365312-001-01	365313-001-01
Large	365312-002-01	365313-002-01
X-Large	365312-003-01	365313-003-01
2XL	365312-004-01	365313-004-01
3XL	365312-005-01	365313-005-01
4XL	365312-006-01	365313-006-01
5XL	365312-007-01	365313-007-01

Size	Green Mesh Part Number	Green Solid Part Number
Small	365314-000-01	365315-000-01
Medium	365314-001-01	365315-001-01
Large	365314-002-01	365315-002-01
X-Large	365314-003-01	365315-003-01
2XL	365314-004-01	365315-004-01
3XL	365314-005-01	365315-005-01
4XL	365314-006-01	365315-006-01
5XL	365314-007-01	365315-007-01

100% polyester mesh/solid, hi-vis orange/green. Sold individually. 5 point breakaway, shoulders, sides and front closure. Closure: velcro. 2" silver tape reflective material - 1 horizontal stripe. Pockets: 1 upper and lower left inside, 1 lower right outside. 3rd party certified, meets ANSI/ISEA 107-2015, Class 2 Type R standards.



Zippered Safety Vests*

Size	Hi-Vis Orange Part Number	Hi-Vis Green Part Number
Medium	365316-001-01	365318-001-01
Large	365316-002-01	365318-002-01
X-Large	365316-003-01	365318-003-01
2XL	365316-004-01	365318-004-01
3XL	365316-005-01	365318-005-01
4XL	365316-006-01	365318-006-01
5XL	365316-007-01	365318-007-01

100% polyester mesh. Class 2 safety vests with two-tone trim. Zipper closure. Pockets: 1 upper left front, 1 lower right inside. 2" silver reflective material. 25 wash max. Meets ANSI/ISEA 107-2015, Class 2 Type R standards.



Solid



Mesh

Safety Vests*

Size	Solid Part Number	Mesh Part Number
Medium	365311-001-01	365310-001-01
Large	365311-002-01	365310-002-01
X-Large	365311-003-01	365310-003-01
2XL	365311-004-01	365310-004-01
3XL	365311-005-01	365310-005-01
4XL	365311-006-01	365310-006-01

Sold individually. Velcro closure, Solid – 2 hip and 1 chest pocket, Mesh – no pockets. Meets ANSI 107-2015 Class 2 standards. Allows greater visibility with orange stripe and reflective tape.



Black Zippered Safety Vests

Size	Black Mesh * Part Number	Black Mesh Crown Branded Part Number
Small	365309-000-01	365309-000-01-C
Medium	365309-001-01	365309-001-01-C
Large	365309-002-01	365309-002-01-C
X-Large	365309-003-01	365309-003-01-C
2XL	365309-004-01	365309-004-01-C
3XL	365309-005-01	365309-005-01-C
4XL	365309-006-01	365309-006-01-C
5XL	365309-007-01	365309-007-01-C

100% polyester mesh. Class 1 safety vests with two-tone trim. Zipper closure. Pockets: 1 upper left front, 1 lower right inside. 2" silver reflective material. 25 wash max. Meets ANSI/ISEA 107-2015, Class 1 Type O standards.

⚠️ **WARNING:** Cancer and reproductive harm - www.P65Warnings.ca.gov

*Available only to customers in USA

Safety Apparel



Bouffant Caps*

Part Number	Description
365304	21" white bouffant cap required to wear in food and medical facilities. Polypropylene. 500/case.



White Protection Coveralls - Zipper Front*

Part Number	Size	Sales Unit
365302-001-12	Medium	12 per case
365302-002-12	Large	12 per case
365302-003-12	X-Large	12 per case
365302-004-12	2XL	12 per case
365302-005-12	3XL	12 per case

Liquid & particulate protection, similar to TYVEK A40. Breathable, elastic wrists and ankles, elastic back for improved fit. Microporous disposable coverall zipper front. Durable and abrasion resistant. Excellent for painting, pressure washing, general maintenance.



Paint Suit*

Part Number	Size
365303-001-01	Medium
365303-002-01	Large
365303-003-01	X-Large
365303-004-01	2XL
365303-005-01	3XL

Gray, 65/35 poly/cotton. Zipper front, hood, adjustable velcro wrist closures. Elastic back and action seat for ease of movement. Machine washable.



Blue Protection Coveralls - Zipper Front*

Part Number	Size	Sales Unit
365300-002-12	Large	12 per case
365300-003-12	X-Large	12 per case
365300-004-12	2XL	12 per case
365300-005-12	3XL	12 per case

Provides protection against dry particulates and light liquid splash. Breathable, elastic wrists and ankles, zipper flap. Seamless front. Durable and abrasion resistant. Meets ANSI/ISES 101-1996 sizing standard.



Vinyl Apron*

Part Number	Sales Unit
365278-012	12 per case

Economical, 6 mil, blue. Resistant to solvents, chemicals, oil and grease. Provides tear, abrasion and puncture resistance.

⚠ **WARNING:** Cancer and reproductive harm - www.P65Warnings.ca.gov



Apron*

Part Number	Size
365260-001	35" x 45"

Expanded PVC coated material with fabric backing. Use with batteries. Waterproof and abrasion resistant.



Knit Cap with LED Light*

Part Number	Color
365305-001	Black
365305-002	Yellow
365305-003	Orange

100% acrylic knit. Rechargeable LED light can be charged with USB port. Light functions include High, Medium and Flash 150 lumens. Meets CE and RoHS standards.



Welding Jacket

Part Number	Size
323017-000-01	Small
323017-001-01	Medium
323017-002-01	Large
323017-003-01	X-Large
323017-004-01	2XL
323017-005-01	3XL
323017-006-01	4XL
323017-007-01	5XL
323017-008-01	6XL

Cool, comfortable and washable, this jacket offers protection from sparks in light welding applications. 30" length. Weldlife™ flame retardant 100% cotton fabric — anti-static, rot and mildew resistant. Relaxed fit design offers comfort for all-day wearability. Adjustable snap wrist, and large inside pocket. Leather reinforced black anodized non-reflective snaps.



Welding Gloves*

Part Number	Sales Unit	Size
365473	1 pair	One Size

Economy welding glove. 13" length. Fully cotton lined and welted cowhide.

Insulating Gloves – Class 0*

Part Number	Sales Unit	Size
365486-008	1 pair	8 / M
365486-009	1 pair	9 / L
365486-010	1 pair	10 / XL
365486-011	1 pair	11 / XXL

Class 0 insulating rubber gloves. Orange. Type 1. 1000v ac capacity.

⚠ **WARNING:** Cancer - www.P65Warnings.ca.gov



Chemical Resistant PVC Gloves*

Part Number	Sales Unit	Length/Finish
365487-012	12 pack	12" Rough
365488-012	12 pack	12" Smooth
365489-012	12 pack	18" Smooth

Chemically resistant to oil, grease, acids and solvents. Provides moderate abrasion resistance. Black.



*Available only to customers in USA

Hard Hats

Hard Hat*

Part Number	Color
365470-001	Blue
365470-002	High Vis Green
365470-003	Red
365470-004	White
365470-005	Yellow
365470-006	Orange



- High density polyethylene construction
- 4 point ratchet suspension
- Meets ANSI Z89.1-2014 standard, type 1, class C, G & E



Note: Universal hard hat adapter (P.N. 365262) is listed on page 2.11 and attachable ear muffs (P.N. 365283) on page 2.09.



Hard Hat

Part Number	Color	Brand
365475	Grey	Crown

- Four position harness points allows moving the harness forward, backward, up or down.
- Made with ABS material, strong yet ultralight weight.
- Easy to grasp triangular knob adjusts from 6.5 to 8 inch hat size.
- Low profile design offers a low center of gravity for better balance.
- Meets ANSI Z89.1-2009 Standards, Type 1, Class C, G, and E & CSA Z94.1-05.

Cooling Products



Hard Hat Cooling Pad*

Part Number	Size	Sales Unit
365499-025	One Size Fits All	25/box

Evaporative cooling material provides hours of heat stress relief. Fits on the suspension of a hard hat with hook and loop closures. To activate, soak in cool water for 2-5 minutes. Reuseable, just reactivate. Blue.



Cooling Towel*

Part Number	Dimensions	Sales Unit
365496-012	26" x 17"	10/box

Made with advanced technology that accelerates the evaporative cooling process. Soak the towel in water for 2-3 minutes and experience cooling relief for up to 5 hours, depending on humidity levels. Anti-Microbial treated to help prevent mold build-up and unwanted smells. Safe and reusable; reusable packaging. Blue.



Cooling Headband*

Part Number	Color	Size	Sales Unit
365498-012	Blue	One Size Fits All	1 dozen
365497-012	Lime Green	One Size Fits All	1 dozen

Made with advanced technology that accelerates the evaporative cooling process. Soak in water for 2-3 minutes and experience cooling relief for up to 5 hours, depending on humidity levels. Anti-Microbial treated to help prevent mold build-up and unwanted smells. Safe and reusable. Patent pending stretch-fit design allows for better blood circulation and comfort. Heat stress safety management.

*Available only to customers in USA

Lockout Tag Out Kit (single connector only)



Part Number

300037 (includes 10 lockout tags)
(Dual language tags English \ Spanish)

Fits - SB and SBX connectors
Fits - 50, 175 and 350 AMP connectors

Individual Items

300037-002 (box only)
300037-003 (lock only)

Accessories:

Tag Refill Kit (Qty. 25 pc)
P.N. 300037-025



Electrical Breaker Lockout Tagout Kit

Part Number

365009

Kit contains:

- (1) 1" Steel Lockout Hasp
- (1) 480/600V and (2)120/277V Clamp-on Circuit Breaker Lockouts
- (1) Nylon Safety Lockout Padlock
- (5) Lockout Tags and (5) Zip Ties
- (1) Lockout Pouch with belt loop on the back



⚠️ **WARNING:** Cancer and reproductive harm - www.P65Warnings.ca.gov

Lock Out Box (dual connectors)



Note: Lock Not Included

Part Number

300420

Fits - SB, SBX, and DIN connectors
Fits - 50, 175 and 350 AMP connectors

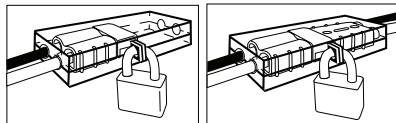

Lock Out

Lock Together

Lockout Cinch Sack

Part Number

365006

Electrical lockout device designed for oversized and hard-to-reach connections. Accommodate up to 6 padlocks. Fits hanging controls, oversized levers and plugs. Size: 7" x 17". Color: Red.



Note: Lock not included. Single lock PN 300037-003

Circuit Breaker Lockout Single



Part Number

365010

Compatible for padlocks with a shackle diameter up to 7mm; lock handle width <= 18mm. Uses thumbscrew to clamp lockout securely. Made from rugged polypropylene.

Barricade/Caution Tape*

Part Number

365265

Sales Unit

Single

Weather resistant. Compliant under OSHA standards, 1910-144(A) physical standards. 3" x 1000', 3.0 mil.



⚠️ **WARNING:** Cancer and reproductive harm - www.P65Warnings.ca.gov

Fire Extinguisher



Part Number

079528 (includes bracket)

2.5 lb. multi-purpose ABC dry chemical with aluminum valve

Accessory:
Mounting Bracket (P.N. 379528)

Note: See Work Assist section for other kits.



Fire Extinguisher

Part Number

127237 (includes bracket/two straps)

2.5 lb. multi-purpose ABC dry chemical with aluminum valve

Accessory:
Mounting Bracket (2 strap)
(P.N. 379528-002)

Note: See Work Assist section for other kits.



*Available only to customers in USA

Safety Related Accessories



Collapsible Safety Cone*

Part Number	Height
365268	28"

Orange with 6" and 4" reflective collars, collapses to less than 3" for stowing and transporting, vinyl carrying case. Meets MUTCD specifications. Optional flashing hazard light - P.N. 365269.



Flashing Cone Light*

Part Number
365269

2" safety light that will fit collapsible cone - P.N. 365268. Provides 130 flashes per minute. Uses 2 AA batteries.



Programmable Security Lock

This keypad offers an enhanced level of security to deter unauthorized or untrained personnel from operating the vehicle. A four digit Personal Identification Number can be assigned for up to 200 operators that use the vehicle. Supervisor can "lockout" vehicle through keypad and can program keypad to turn vehicle "OFF" automatically if vehicle is idle for prolonged periods.

Power input is 15 amps externally fused, 48 volts maximum. Power output is 10 amps maximum. Operating temperature range is -40 to +85° Celsius.

Part Number	Used on	Kit Instructions
130863-001	Wave	
130863-002	RC3, FC4, Turret, SP48, SP3000	
130863-003	WP2300	PF26004
130863-003	WP3000	PF26265

Kit Instructions for Programming

PF11830	Dealer Level
PF11831	Manager Level
PF11832	Supervisor Level



Safety/Traffic Cones*

Part Number	Height
365266-001	18"
365266-002	28"

Tough all-weather orange cones. 100% PVC. Meets federal MUTCD & NCHRP-350 specifications.

365266-001



Safety/Traffic Cone*

Part Number	Color	Height
365266-003	Orange	28"

Tough all-weather cone. 100% PVC. Meets federal MUTCD & NCHRP-350 specifications. 4" & 6" reflective collars.

*Available only to customers in USA

Spill Absorbent Products

Be prepared for a variety of accidental spills



Acid Spill Absorber and Neutralizer

Part Number	Sales Unit	Absorbs
300421	25 lbs.	6 gallons of electrolyte
300421-030	160 lbs.	40 gallons of electrolyte

- Specifically formulated to absorb and neutralize battery acid, with color change to show when acid is neutralized and safe for disposal
- Ideal for use in acid drip pans
- Safe and non-hazardous
- Sweeps up clean and dry, is not dusty like kitty litter/clay
- Durable easy to store container with resealable lid
- Instructions and MSDS included See OSHA 1926.441 & 1910.173

Cold Form: Uses pre-formed cotton fibers. These cotton fibers, once processed, provide a high degree of strength, durability & absorbency. Requires less energy to produce, earth-friendly/green, made from renewable & recycled resources. Poly backed pads prevent leaks from penetrating to surface below.



Pads*

Part Number	Sales Unit
365321-100	Gray, 15" x 18", 100/case



Earth friendly/green. Large liquid holding capacity. Quick absorbency. Long product life. Great for fast cleanup. Absorbs oil, coolants, solvents and water.



QuiKleen Absorbent Powder

Part Number	Sales Unit
363201	Case (4) Easy Pour Jugs
363205	5 Gallon Pail

QuiKleen Absorbent Powder is an instant response to your most frequent liquid spill needs. It is an environmentally safe product that is landfill acceptable and EPA certified. Absorbs gas, oil, coolants, water, eggs, syrups, paint, blood, vomit, and many solvents. (DO NOT USE IN CLEANUP OF HYDROFLUORIC ACID.)

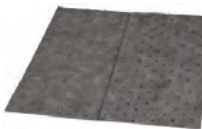

Pads & Rolls*

Part Number	Sales Unit
365323-100	Gray, 15" x 18", 100/case
365324-001	Gray, dimpled, 30" x 150', 1 roll/case, perforated every 18"



Quick absorbency. Large liquid holding capacity. Long product life. Great for fast cleanup. Absorbs oil, coolants, solvents and water.



Matting*

Part Number	Sales Unit
365320-001	36" x 150' roll; 1 roll/case

Use as a maintenance rug. Keep liquid from damaging floors. Absorbs non-aggressive liquids. Non-perforated.



Drum Top Covers*

Part Number	Sales Unit
365325-025	Gray, 25/case

Absorb excess liquids on top of 55 gallon drum.



Adhesive Mat*

Part Number	Sales Unit
365329-050	Gray, 34" x 50', 1 roll/case
365329-100	Gray, 34" x 100', 1 roll/case

SureGrip™ adhesive absorbent mat. Highly absorbent, soaks moisture and wicks it away to prevent puddling, fast drying, easy to clean. Adhesive-backed, stays put - no shifting, bunching, or flipping over. Durable Needle Punch manufacturing - withstands forklift traffic. Cut to length, peels up easily for replacement. Fire retardant as per ASTM 726.



Socks*

Part Number	Sales Unit
365326-040	Gray, 42" x 3", 40/case

Flexible to fit around machinery and excellent for containing spills. Absorbs oil, coolants, solvents and water.



Response Kits*

Part Number	Sales Unit
365327-001	1 kit

Packed in a zippered, clear vinyl bag. Labeled with an easy to read yellow safety tag. Oil specific. Includes 20 pads, 2 socks, 2 cleanup bags.

*Available only to customers in USA



Pads*

Part Number	Sales Unit
365328-100	Gray, 15" x 18", 100/case

Fastest absorbing. Superior liquid holding capacity. Longest product life. Absorbs oil, coolants, solvents and water.

Battery Spill Kit

Part Number - 300035*

Note: Instructional label inside lid.

▲ Individual Items

Part Number	Description	Quantity
300042	Face shield	1
300041	Head gear	1
300049	32 oz acid neutralizer (per bottle)	2 bottles
300043	Acid spill absorbent cleanup pads	10
300047	Yellow heavy-duty chemical disposal bag; 33" x 39"	1
300048	Mini broom	1
300051	16 oz eye wash flush*	1 bottle
300044	Green acid resistant glove, nitrile	1 pair
300045	Acid-resistant sleeve	1 pair
300050	Acid-resistant rubber overboot	1 pair
300046	Acid-resistant apron	1
300035-001	Bucket	1

*Three-year shelf life.

Note: Individual part numbers sold by piece or pair.



First Aid Kits

Class A Polywhite First Aid Kit*

Part Number

365291

- Designed for common workplace injuries such as major and minor wounds, minor burns and eye injuries
- Kit meets Z308.1-2015 minimum fill requirements for Class A Type I, II, III or IV
- Color coded and unitized for ease of refills
- Made from heavy duty plastic to withstand tough work environments
- Portable or mountable
- Kit will continue to remain compliant only when it is maintained with products that meet the standard at specific quantities



ProWorks® First Aid Kit*

Part Number

365290-010

- For groups of 10
- Should be in clear view of workers in case of accidents
- Kit includes: Bandages, gauze, adhesive tape, antiseptic, cold pack, scissors, soothing sting swabs, burn cream packets, and cut cleaner



First Aid Kit

Part Number

365293

- Contains: (1) Emergency First Aid Pocket Guide, (1) 1/2"x5yd. Tape, (1) Eye Wash 4oz., (1) Elastic Gauze 2"x4.5yd., (1) Disposable Forcep, (1) Wound Seal, (2 pr.) Nitrile Gloves, (1) 3-1 Antibiotic Ointment, (1) Waterjel Burn Pack, (1) Ice Pack Small, (1) 40" Triangular Bandage, (1) 4" Compress Bandage, (10) Fingertip Bandages, (10) Knuckle Bandages, (16) Plastic 1"x3" Bandages, (1) 2oz. Antiseptic Spray, (10) Clean Wipes, (4) 3"x3" Gauze Pads, (1) Metal Kit Box.
- Meets ANSI standard for workplace vehicle kits under ANSI Z308.1-2015.
- Dimensions: 9.5" Wide x 7" Tall x 2.5" Deep.



Class B Metal First Aid Kit*

Part Number

365292

- Designed for high risk work zones such as construction, utilities, industrial and manufacturing
- Kit meets Z308.1-2015 minimum fill requirements for Class B Type I, II, III or IV
- Suggested for any work zone where personal protective equipment is required
- Color coded and unitized for ease of refills
- Made from heavy duty metal to withstand tough work environments
- Portable or mountable
- Kit will continue to remain compliant only when it is maintained with products that meet the standard at specific quantities



*Available only to customers in USA

Section 3

Warehouse

Contents

Bollards and Bumpers	3.02
Rack Protection	3.03
Mirrors	3.04
Floor Tape	3.05
Floor Signs	3.09
Ladders and Platforms	3.10
Pallets and Accessories	3.11
Wheel Chocks	3.12
Jacks	3.13
Hand Trucks	3.15
Hoppers	3.16
Dockboards	3.18
Tubes	3.18
Floor Mats	3.19
Biljax OEM Parts	3.20
Genie OEM Parts	3.22

New Items:

Blue Aerial Operator Access Card - p. 3.23

Note: 1910.178(q)(5) (1998) of the Occupational Safety and Health Act (OSHA) requires that "All parts of any such industrial truck requiring replacement shall be replaced only by parts equivalent as to safety with those used in the original design."

The installation onto a lift truck of non-certified electronic components may invalidate a truck's UL EE or LPS listing and could pose a safety risk. Customers with UL-listed lift trucks are solely responsible for ensuring compliance with UL for field modifications. The selection of non-OEM parts is made solely by the customer with the awareness that OEM parts are available. Crown Equipment Corporation is unaware of what testing and/or certification, if any, the non-OEM parts have undergone and disclaims all warranties and representations regarding any non-OEM part.



Bollards and Bumpers

Steel Pipe Safety Bollard*

Part Number	Dimensions
360039-078	24" x 4½"
360039-079	24" x 5½"
360039-080	36" x 4½"
360039-081	36" x 5½"
360039-082	42" x 4½"
360039-083	42" x 5½"



360039-081

▲WARNING: Cancer and reproductive harm - www.P65Warnings.ca.gov

Bollard - 4¼" Diameter*

Durable construction. Includes a top mounted eyelet for safety chains or ropes. Unit is lockable, two keys included.

Part Number	Description
360039-1341	Fixed Height
360039-1342	Fold-Down, Yellow
360039-1343	Fold-Down, Stainless



360039-1341

360039-1342

360039-1343

▲WARNING: Cancer and reproductive harm - www.P65Warnings.ca.gov

Bollard - 2½" Diameter*

Bollards feature durable construction for lasting through the harshest environments. Includes a top mounted eyelet for safety chains or ropes for maximum efficiency. Includes 2 wrap-around reflectors.

Part Number	Description
360039-1346	Fixed Height
360039-1347	Fold-Down



360039-1346

360039-1347

▲WARNING: Cancer and reproductive harm - www.P65Warnings.ca.gov

Laminated Dock Bumpers*

Designed for use on loading docks to protect trailers and dock area. Bolt or weld bumper to the dock. Made from recycled truck tires. Width is bolt hole center to bolt hole center. Installation hardware not included.

Part Number	Description
360039-138	6" x 24" x 4.5" Projection
360039-139	6" x 36" x 4.5" Projection
360039-109	10" x 12" x 4.5" Projection
360039-112	10" x 12" x 4.5" Projection - Flat one side
360039-110	10" x 12" x 6" Projection
360039-111	10" x 14" x 4.5" Projection
360039-113	10" x 14" x 6" Projection
360039-114	10" x 18" x 4.5" Projection
360039-115	10" x 18" x 6" Projection
360039-116	10" x 24" x 4.5" Projection
360039-117	10" x 24" x 6" Projection
360039-118	10" x 30" x 4.5" Projection
360039-119	10" x 30" x 6" Projection
360039-120	10" x 36" x 4.5" Projection
360039-121	10" x 36" x 6" Projection
360039-122	10" x 96" x 4.5" Projection
360039-123	12" x 12" x 4.5" Projection
360039-124	12" x 12" x 6" Projection
360039-125	12" x 14" x 4.5" Projection
360039-126	12" x 14" x 4.5" Projection - Flat one side
360039-127	12" x 14" x 6" Projection
360039-128	12" x 18" x 4.5" Projection
360039-129	12" x 18" x 6" Projection
360039-130	12" x 24" x 4.5" Projection
360039-131	12" x 24" x 6" Projection
360039-132	12" x 30" x 4.5" Projection
360039-133	12" x 30" x 6" Projection
360039-134	12" x 36" x 4.5" Projection
360039-135	12" x 36" x 6" Projection
360039-136	12" x 96" x 4.5" Projection
360039-137	12" x 96" x 6" Projection



360039-109



360039-126



360039-138

▲WARNING: Cancer and reproductive harm - www.P65Warnings.ca.gov

*Available only to customers in USA

Specialty Molded Dock Bumpers*

Manufactured from fiber reinforced prime rubber containing nylon and polyester. Features: Simple installation for immediate use. Use on loading dock to protect trailer & dock. Pre-drilled countersunk mounting holes make installation easy. Installation hardware not included.

Part Number	Steps	Wheels
360039-101	L-Shaped	18" x 18" x 4"
360039-099	Plastic Face	12" x 13" x 4"
360039-095	Rectangular	12" x 12" x 3"
360039-102	Rectangular	16" x 5" x 2"
360039-103	Rectangular	18" x 8" x 2"
360039-096	Rectangular	24" x 12" x 6"
360039-098	Square	12" x 13" x 4"
360039-104	Steel Faced	5" x 16" x 2"
360039-105	Steel Faced	8" x 18" x 2"
360039-097	T-Shaped	22" x 22" x 3"



360039-095



360039-097



360039-098



360039-101



360039-104

▲WARNING: Cancer and reproductive harm - www.P65Warnings.ca.gov

Rack Protection

Overhead Door Track Protector*

Angle design protects track for overhead doors from damage. Universal design may be used on either left or right side of door. Easy-to-install design only requires three bolts. Heavy-duty steel construction provides durable long-lasting use.

Part Number	Description
360039-721	36.25"
360039-722	48.25"

360039-721

360039-722

WARNING: Cancer and reproductive harm - www.P65Warnings.ca.gov



Structural Rack Guard*

Heavy-duty cast steel construction. Powder-coat yellow. Four pre-drilled mounting holes in base plate allow quick lag down installation. Installation hardware sold separately.

Part Number	Description
360039-936	24" x 8"
360039-937	36" x 8"
360039-938	24" x 10"
360039-939	36" x 10"

360039-938

360039-939

WARNING: Cancer and reproductive harm - www.P65Warnings.ca.gov



Rack Protector

Part Number - 351097-202

Molded of energy-absorbing rubber with a "U-shaped" steel insert and force-distributing rubber voids. Protects rack structure from frontal, angled and side impacts. Snaps onto rack for protection. Requires no hardware or straps to retain the guard column. 12" x 5.5" - snaps onto rack for protection.



*Available only to customers in USA

Forklift Enclosure Atriums and Forklift Cap Covers

Protect Your Investment

- Easy installation
- Great for the yard and warehouse
- Cap covers provide protection from falling debris and rain
- Designed to improve working conditions and protect equipment



See Section 6
for Work Assist

CROWN

Dual Tandem Load Wheels

For use on Crown Pallet Trucks PC, PE, PR and PW with 9" and 10" forks

- Reduce Flat Spotting
- Independent Wheel Rotation



See the Wheels and Tires Section

Mirrors

Warehouse Mirror Features: • Easy install • Lightweight design • Shatter resistant • Grade A optical acrylic

Round Convex Mirror*

Indoor and outdoor models available. Hanging hardware included.

Part Number	Diameter	Distance Covered	Use
360039-7360	12"	12'	Indoor
360039-7361	18"	20'	Indoor
360039-7363	26"	26'	Indoor
360039-7366	30"	30'	Indoor
360039-7362	18"	20'	Outdoor
360039-7365	26"	26'	Outdoor
360039-7367	30"	30'	Outdoor
360039-7368	36"	36'	Outdoor



360039-7362

⚠️ **WARNING:** Cancer and reproductive harm - www.P65Warnings.ca.gov

Wide View Convex Mirror*

Wide view design for expanded viewing distance. Indoor and outdoor models available. Outdoor use mirrors feature a weatherable polyethylene back. Hardware included.

Part Number	Diameter	Depth	Distance Covered	Use
360039-7369	16"	4"	16' to 20'	Indoor
360039-7370	24"	5"	25' to 30'	Indoor
360039-7371	32"	7"	35' to 40'	Indoor
360039-7372	16"	4"	16' to 20'	Outdoor
360039-7373	24"	5"	25' to 30'	Outdoor
360039-7374	32"	7"	35' to 40'	Outdoor



360039-7373

⚠️ **WARNING:** Cancer and reproductive harm - www.P65Warnings.ca.gov

Dome Mirror*

Dome mirrors provide maximum viewing angles. Full dome and half dome models available. Hanging hardware included. For indoor use.

Part Number	Diameter	Distance Covered	Dome
360039-7375	18"	18'	Full Dome (360 Degree)
360039-7376	28"	26'	Full Dome (360 Degree)
360039-7377	34"	32'	Full Dome (360 Degree)
360039-7378	36"	36'	Full Dome (360 Degree)
360039-7379	18"	18'	Half Dome (180 Degree)
360039-7380	28"	26'	Half Dome (180 Degree)
360039-7381	34"	32'	Half Dome (180 Degree)



360039-7378



360039-7379

⚠️ **WARNING:** Cancer and reproductive harm - www.P65Warnings.ca.gov

Oblong Hallway Mirror*

Convex mirror with 180 degree viewing at eye level. For indoor use. Hardware included.



Part Number	Dimensions	Distance Covered
360039-7382	16"W x 7-3/4"H	10' to 12'

⚠️ **WARNING:** Cancer and reproductive harm - www.P65Warnings.ca.gov

Rectangular Convex Mirror*

For indoor use. Hardware included.



Part Number	Dimensions	Distance Covered
360039-7364	26"W x 18"H	26'

⚠️ **WARNING:** Cancer and reproductive harm - www.P65Warnings.ca.gov

Inspection Mirror*

Part Number	Diameter	Distance Covered	Description
360039-7384	8"	8'	35" handle

⚠️ **WARNING:** Cancer and reproductive harm - www.P65Warnings.ca.gov



360039-7384

*Available only to customers in USA

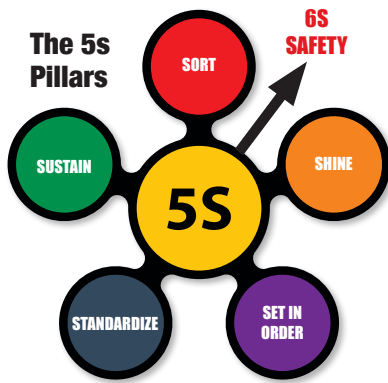

5s Floor Color Recommendations

Use safety tapes, floor markers, and safety floor signs to identify, communicate, and reinforce proper safety practices.

Your facility will shine with the proper placement inventory tools, and machinery identified with brightly colored floor tapes, markers and signs.

Set things in order by using different color floor tapes and floor markings to show work flow patterns, establish borders between work areas and mark the proper placement of tools, inventories, and machinery. Sort your critical work areas and crucial inventory areas with floor tape and floor markers to obtain optimal production.

Sustain your 5s implementation by standardizing your 5s procedures and using the same floor tape products for certain areas throughout the facility.

Safety YELLOW - Caution: Pedestrian Aisle Ways

Safety RED - Safety Areas – Emergency Exit Ways and Do Not Block Fire Extinguishers

Safety WHITE - Production Equipment – Machines, Carts, Incoming Racks

Safety GREEN - Safety Related Equipment/Raw Material Areas – Eye Wash Stations & Spillage Showers

Safety ORANGE - Parts for Machinery Area

Safety BLUE - Work in Process Area or Equipment Under Repair Zone

Safety BLACK - Finished Goods Area

Safety YELLOW/BLACK - Extra Caution Areas – Pedestrian Walkways or Aisle Ways

Safety RED/WHITE - Safety Equipment Areas – Fire Extinguishers, Electrical Panels, AED Machines, etc.

Floor Tape Features: • Installs quickly • Removable adhesive backing • Beveled edges • Removes easily • 3-year warranty

Solid Floor Tape - 100' Roll



Color	2" Wide	3" Wide	4" Wide	6" Wide
Black	351097-001	351097-056	351097-115	351097-144
Blue	351097-002	351097-057	351097-116	351097-145
Brown	351097-003	351097-058	351097-117	351097-146
Gray	351097-004	351097-059	351097-118	351097-147
Green	351097-005	351097-060	351097-119	351097-148
Orange	351097-006	351097-061	351097-120	351097-149
Purple	351097-008	351097-062	351097-122	351097-150
Red	351097-010	351097-063	351097-124	351097-151
White	351097-012	351097-064	351097-126	351097-152
Yellow	351097-042	351097-093	351097-130	351097-155

Floor Tape with Center Line - 100' Roll



Color	Line Color	2" Wide	4" Wide
Orange	Blue	351097-007	351097-121
Red	White	351097-011	351097-125
Yellow	Black	351097-043	351097-131
Yellow	Blue	351097-045	351097-133

Floor Tape with Chevrons - 100' Roll



Color	Chevrons	2" Wide	3" Wide	4" Wide	6" Wide
White	Black	351097-013	351097-065	351097-127	351097-153
White	Red	351097-014	351097-066	351097-128	351097-154
Yellow	Black	351097-044	351097-094	351097-132	351097-156

4" Yellow Reflective Center Line Floor Tape - 75' Roll

Part Number - 351097-195



Luminescent Center Line Floor Tape - 100' Roll

Luminescent center line highlights exit paths during power outages.



Color	2" Wide	4" Wide
Red	351097-009	351097-123
Yellow	351097-041	351097-129

Floor Tape with Chevrons - 100' Roll



Color	2" Wide	4" Wide
White/Blue	351097-200	351097-199
White/Green	351097-201	351097-198

Brick Floor Tape - 100' Roll

Color	2" Wide
Yellow	351097-196
Blue	351097-197

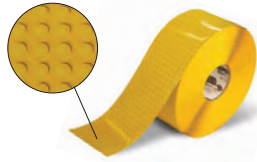

Freezer Floor Tape - 100' Roll

Color	2" Wide	4" Wide
Yellow	351097-246	351097-194
Clear	351097-226	351097-227



Anti-Slip Floor Tape - 60' Roll



Color	2" Wide	3" Wide	4" Wide	6" Wide
Yellow	351097-211	351097-212	351097-213	351097-214
Black	351097-215	351097-216	351097-217	351097-218
Glow	351097-219	351097-220	351097-221	351097-222

Anti-Slip Chevron Floor Tape - 60' Roll

Color: Black & Yellow



2" Wide	3" Wide	4" Wide	6" Wide
351097-248	351097-247	351097-249	351097-250



Floor Tape Applicator

Part Number	Tape Width
351097-364	2", 3", 4"

⚠ WARNING: Cancer - www.P65Warnings.ca.gov

Segment



Color	10"L x 2"W (Single)	10"L x 3"W (Single)	10"L x 4"W (Single)	10"L x 6"W (Single)
Yellow	351097-293-01	351097-305-01	351097-318-01	351097-331-01
Red	351097-294-01	351097-306-01	351097-319-01	351097-332-01
White	351097-295-01	351097-307-01	351097-320-01	351097-333-01
Green	351097-296-01	351097-308-01	351097-321-01	351097-334-01
Blue	351097-297-01	351097-309-01	351097-322-01	351097-335-01
Orange	351097-252-01	351097-310-01	351097-323-01	351097-336-01
Gray	351097-298-01	351097-311-01	351097-324-01	351097-337-01
Purple	351097-299-01	351097-312-01	351097-325-01	351097-338-01
Black	351097-300-01	351097-313-01	351097-326-01	351097-339-01
Brown	351097-301-01	351097-314-01	351097-327-01	351097-340-01
Yellow/Black Chevron	351097-302-01	351097-315-01	351097-328-01	351097-341-01
White/Black Chevron	351097-303-01	351097-316-01	351097-329-01	351097-342-01
White/Red Chevron	351097-304-01	351097-317-01	351097-330-01	351097-343-01

Wide, Solid Angle



Color	6"L x 2"W (Single)	6"L x 3"W (Single)	10"L x 4"W (Single)
Black	351097-015-01	351097-067-01	351097-268-01
Blue	351097-017-01	351097-069-01	351097-266-01
Brown	351097-019-01	351097-071-01	351097-271-01
Gray	351097-021-01	351097-073-01	351097-269-01
Green	351097-023-01	351097-075-01	351097-267-01
Orange	351097-025-01	351097-077-01	351097-265-01
Purple	351097-027-01	351097-079-01	351097-270-01
Red	351097-029-01	351097-081-01	351097-264-01
White	351097-031-01	351097-083-01	351097-272-01
Yellow	351097-037-01	351097-089-01	351097-263-01

Wide, Solid T-Shaped & Angles w/Chevrons



Color	Shape	Chevrons	2" Wide (Single)	3" Wide (Single)
White	T	Black	351097-035-01	351097-087-01
White	T	Red	351097-036-01	351097-088-01
Yellow	T	Black	351097-040-01	351097-092-01
White	Angle	Black	351097-032-01	351097-084-01
White	Angle	Red	351097-033-01	351097-085-01
Yellow	Angle	Black	351097-038-01	351097-090-01



Wide, Solid T-Shaped

Color	2" Wide (Single)	3" Wide (Single)
Black	351097-016-01	351097-068-01
Blue	351097-018-01	351097-070-01
Brown	351097-020-01	351097-072-01
Gray	351097-022-01	351097-074-01
Green	351097-024-01	351097-076-01
Orange	351097-026-01	351097-078-01
Purple	351097-028-01	351097-080-01
Red	351097-030-01	351097-082-01
White	351097-034-01	351097-086-01
Yellow	351097-039-01	351097-091-01

Mini Angles



Color	2"L x .75"W (Single)
Yellow	351097-236-01
Red	351097-237-01
Orange	351097-238-01
Blue	351097-239-01
Green	351097-240-01
Black	351097-241-01
Gray	351097-242-01
Purple	351097-243-01
Brown	351097-244-01
White	351097-245-01

Wide, Half Angle or X



Color	2" Wide (Single)
Black	351097-258-01
Blue	351097-256-01
Brown	351097-261-01
Gray	351097-259-01
Green	351097-257-01
Orange	351097-253-01
Purple	351097-260-01
Red	351097-255-01
White	351097-262-01
Yellow	351097-254-01

Arrow



Color	10"L x 6"W (Single)
Black	351097-367-01
Blue	351097-169-01
Brown	351097-170-01
Gray	351097-181-01
Green	351097-182-01
Orange	351097-183-01
Purple	351097-184-01
Red	351097-185-01
White	351097-186-01
Yellow	351097-189-01

Arrow Roll



Color	4" Wide (280 Arrows)	5.5" Wide (200 Arrows)
Yellow	351097-354	351097-344
Red	351097-355	351097-345
Orange	351097-356	351097-346
Blue	351097-357	351097-347
Green	351097-358	351097-348
Black	351097-359	351097-349
Gray	351097-360	351097-350
Purple	351097-361	351097-351
White	351097-362	351097-352
Brown	351097-363	351097-353











Arrow with Chevrons



Color	Chevrons	10"L x 8"W (Single)
White	Black	351097-187-01
Yellow	Black	351097-190-01
White	Red	351097-188-01

Floor Tape

Solid Dot

Color	.75" Diam (Single)	1" Diam. (Single)	2.7" Diam. (Single)	3.5" Diam. (Single)	3.75" Diam. (Single)	5.7" Diam (Single)
	Black 351097-273-01	351097-283-01	351097-046-01	351097-095-01	351097-105-01	351097-134-01
	Blue 351097-274-01	351097-284-01	351097-047-01	351097-096-01	351097-106-01	351097-135-01
	Brown 351097-275-01	351097-285-01	351097-048-01	351097-097-01	351097-107-01	351097-136-01
	Gray 351097-276-01	351097-286-01	351097-049-01	351097-098-01	351097-108-01	351097-137-01
	Green 351097-277-01	351097-287-01	351097-050-01	351097-099-01	351097-109-01	351097-138-01
	Orange 351097-278-01	351097-288-01	351097-051-01	351097-100-01	351097-110-01	351097-139-01
	Purple 351097-279-01	351097-289-01	351097-052-01	351097-101-01	351097-111-01	351097-140-01
	Red 351097-280-01	351097-290-01	351097-053-01	351097-102-01	351097-112-01	351097-141-01
	White 351097-281-01	351097-291-01	351097-054-01	351097-103-01	351097-113-01	351097-142-01
	Yellow 351097-282-01	351097-292-01	351097-055-01	351097-104-01	351097-114-01	351097-143-01

Footprint



Color	Large - 1 pair (12"L x 5"W)	Small - 1 pair (9.5"L x 3.5"W)
Black	351097-157-01	351097-171-01
Blue	351097-158-01	351097-172-01
Brown	351097-159-01	351097-173-01
Gray	351097-160-01	351097-174-01
Green	351097-161-01	351097-175-01
Orange	351097-166-01	351097-176-01
Purple	351097-167-01	351097-177-01
Red	351097-168-01	351097-178-01
White	351097-191-01	351097-179-01
Yellow	351097-192-01	351097-180-01

Footprint with Luminescent Center Line

1 Pair - 9.5"L x 3.5"W

Part Number - 351097-193 -01



Label Protectors

Part Number	Description
351097-165-01	10" x 6"
351097-366-01	10" x 6" (Heavy Duty: 50 mil thick)
351097-373-01	13" x 10"

All Purpose Floor Cleaner

Part Number	Description
351097-164	1 Gallon Container

Green heavy duty cleaner used for industrial cleaning. Saves time by penetrating, dissolving and safely cleaning any washable surface.



Paint Applicators

Handheld wand applicator is a lightweight applicator used for marking paint lines on ground. Wheels assist in creating an even line for optimal results. Pull trigger to spray applicator holds one standard aerosol.

Part Number	Description
360039-1178	Portable Applicator with Wheels

WARNING: Cancer and reproductive harm - www.P65Warnings.ca.gov



Fire Extinguisher Do Not Block

Part Number	Size
351097-229	24"
351097-206	24" x 36"



351097-229



351097-206

Trash Can 24"

Part Number - 351097-224



First Aid Kit Do Not Block 24"

Part Number - 351097-230



Personal Protection Equipment Must Be Worn At All Times 24"

Part Number - 351097-233



Emergency Eye Wash 24"

Part Number - 351097-228



Safety Glasses Required

Part Number	Size
351097-369	12"
351097-370	16"
351097-371	24"
351097-372	36"



Keep Clear Do Not Block Sign

Part Number	Size
351097-208	24" x 36"
351097-232	24" x 24"



Yellow Forklift Traffic 24"

Part Number - 351097-231



Keep Clear Electrical Panel 24" x 36"

Part Number - 351097-207



Orange Crown Forklift Traffic 17"

Part Number - 351097-210



Yellow Pedestrian Sign 24"

Part Number - 351097-209



Caution Door Swing Area 36"

Part Number - 351097-234



Safety Stop Sign

Part Number	Size
351097-203	16"
351097-204	18"
351097-205	24"
351097-223	48"



Floor Signs

Employees Only

Part Number	Size
351097-376	12"
351097-377	16"



Maintain Distance

Part Number	Size
351097-381	16"



No Entry Beyond This Point

Part Number	Size
351097-378	12"
351097-379	16"



Keep Safe Distance

Part Number	Size
351097-382-01	4" x 36"



Wait Here

Part Number	Size
351097-383	12"
351097-384	16"



Ladders and Platforms

Telescopic Ladder*

Design allows for storage in closets or tight spaces. Spring loaded locking pin automatically engages to secure step height. Bumper guards and molded rubber feet protects walls and floors.



Part Number	Extended Steps	Closed Size (W x D x H)	Step Depth	Cap. (lbs.)	Wt. (lbs.)
360039-2003	6" - 12'	19.25" x 3.5" x 32"	1½"	225	30

⚠️ **WARNING:** Cancer and reproductive harm - www.P65Warnings.ca.gov

Steel Work Platform*

Part Number	Description
360039-056	36" x 36"
360039-057	36" x 48"
360039-058	48" x 48"



360039-057

Notice: Occupant safety depend on maintaining a work platform in level, horizontal position. Only use work platform on improved surfaces (asphalt or concrete) that are even and level. DO NOT mount a work platform on a telehandler, boom lift or rough terrain forklift, even if the handler will be used on level concrete or asphalt.

⚠️ **WARNING:** Cancer and reproductive harm - www.P65Warnings.ca.gov

Fiberglass Multi-Position Ladder

Conquest™ 2.0 converts to stepladder, extension, 90-degree, and staircase configurations. Patented Rapid Lock locks ladder in place. Hi-Viz green fiberglass is lightweight and non-conductive. Weight-balanced carrying handle and Tip & Glide™ Wheels simplify transportation. V-bar and innovative feet on the ladder's extension allows for setup on poles and inside and outside corners. ANSI Type IAA - Special Duty.

Part Number	Model	Load Capacity	Step Ladder Size	Extension Size	Ext Highest Standing Level	Storage Height	Storage Depth	Weight
360052-101	13	375 lbs.	3'5" - 5'5"	7' - 11'	3'8" - 7'6"	3'6"	10"	32 lbs.



*Available only to customers in USA

Pallets and Accessories

Galvanized Steel Pallets*

Finished Steel: Galvanized finish is rust resistant. Unit has a two-way entry allowing fork truck access only. Heavy-duty, non-reversible welded steel.

Welded Wire: Welded steel wire pallet. Galvanized finish. Unit has a four-way entry. Heavy-duty, non-reversible welded steel.

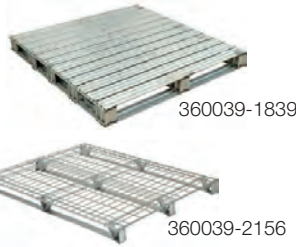

Part Number	Description	Dimensions
360039-1839	Galvanized Finished Steel	48" x 48"
360039-2156	Galvanized Welded Wire	40" x 48"
360039-2157	Galvanized Welded Wire	48" x 48"

⚠️ **WARNING:** Cancer and reproductive harm - www.P65Warnings.ca.gov

Heavy-Duty Aluminum Pallets*

Aluminum Pallet works great in food and chemical industries. Unique design stands up to high-power steam, brushes, or pads. Non-skid surface provides easy transportation of all products. Two-way entry for pallet provides visibility.

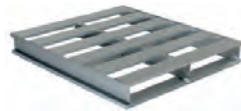

Part Number	Description	Dimensions
360039-2520	Heavy-Duty Aluminum	40" x 48"
360039-2524	Heavy-Duty Aluminum	48" x 48"

⚠️ **WARNING:** Cancer and reproductive harm - www.P65Warnings.ca.gov

Pallet Busters*

Gets rid of broken pallets quickly and safely. Can also be used for dockboard removal. Designed for disassembling pallets easily.

Silver/Regular: Lightweight. Features dual prying action with nail puller.

Blue/Deluxe: Articulating head won't break or split the wood.



Part Number	Description
360039-1788	Silver - Regular
360039-1789	Blue - Deluxe

⚠️ **WARNING:** Cancer and reproductive harm - www.P65Warnings.ca.gov

Pallet Jockey*

Part Number - 360039-107

The adjustable unit is designed to fit various types of electric pallet jacks. To use simply loosen wing bolts and slide adjustable brack to proper slot, then tighten wing bolts. Weight 28 lbs. Maximum Capacity 4,000 lbs.



⚠️ **WARNING:** Cancer and reproductive harm - www.P65Warnings.ca.gov

Yellow Economical Pallet Truck Caddy*

Part Number - 360039-072

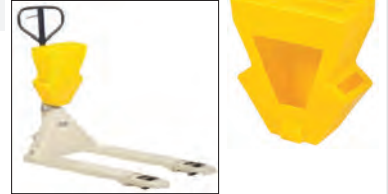

⚠️ **WARNING:** Cancer and reproductive harm - www.P65Warnings.ca.gov

Pallet Puller - 5000 lb. Capacity*



Part Number	Description	Jaw Opening
360039-052	Single Scissor	7"
360039-053	Cam Action	3"
360039-054	Double Scissor	3"
360039-055	Low Profile Double Scissor	3 1/8"

⚠️ **WARNING:** Cancer and reproductive harm - www.P65Warnings.ca.gov

Aluminum Pallet Dolly w/Tilt*



Part Number	Description
360039-065	4,000 lb Capacity, 6 Rollers, 40"x48"
360039-066	6,000 lb Capacity, 8 Rollers, 40"x48"

⚠️ **WARNING:** Cancer and reproductive harm - www.P65Warnings.ca.gov

*Available only to customers in USA

Wheel Chocks*

Reinforced rubber resists tearing, abrasion and ozone weathering. Rubber provides a sure grip on virtually any surface.



360039-004



360039-003

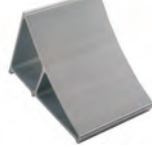

360039-044

Part Number	Type	Dimensions
360039-004	Laminated Rubber	10" x 5.5" x 10"
360039-005	Laminated Rubber	10" x 5.5" x 10" w/grips
360039-006	Laminated Rubber	8" x 8" x 8"
360039-001	Molded Rubber (Eyebolt)	9.25" x 6" x 8"
360039-002	Molded Rubber (Handle)	9.25" x 6" x 8"
360039-003	Molded Rubber (Orange)	9.25" x 6" x 8"
360039-044	Aluminum	10" x 7" x 8"

⚠️ **WARNING:** Cancer and reproductive harm - www.P65Warnings.ca.gov

Wheel Chock - Small

Part Number - 340094-001
3" x 2.5" x 3"



Blocking Outrigger - Large

Part Number - 340094-002
5.8" x 3.6" x 9.5"

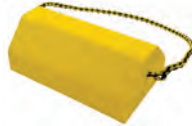

Double Wheel Chock

Part Number - 340094-006
9.5" x 5.9" x 3.6"



Wheel Chock - Fabricated Steel*

Part Number - 360039-874
9.8" x 9.9" x 8.25"



⚠️ **WARNING:** Cancer and reproductive harm - www.P65Warnings.ca.gov

Wheel Chock

Part Number - 340094-004
3" x 4.9" x 2.6"

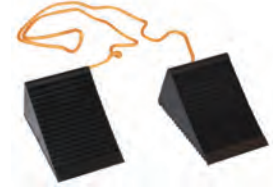

Wheel Chock

Part Number - 340094-003
5" x 4" x 8"



Industrial Rubber Wedge*

Part Number - 360039-1624
24" x 6.75" x 3"

Rubber wedge resilience avoids creasing or wrinkling paper. Increases its grip as weight is increased.



⚠️ **WARNING:** Cancer and reproductive harm - www.P65Warnings.ca.gov

Pallet Truck Stop*

Part Number - 360039-106

Secures pallet truck wheel.



⚠️ **WARNING:** Cancer and reproductive harm - www.P65Warnings.ca.gov

Parking Block - Recycled Plastic 72"*

Part Number	Description
360039-041	Blue
360039-042	Gray
360039-043	Yellow



360039-043

Parking Block - Recycled Rubber*

Part Number	Description
360039-585	71-3/4" x 5-3/4" x 4"
360039-7393	47-1/4" x 5-3/4" x 4"



360039-585

Hardware Kit for Part No. 360039-585

360039-7400	Asphalt Hardware Kit
360039-7401	Heavy Duty Asphalt Hardware Kit
360039-7402	Concrete Hardware Kit
360039-7403	Glue Down Anchor Plate Kit

Hardware Kit for Part No. 360039-7393

360039-7414	Asphalt Hardware Kit
360039-7415	Anchor Kit
360039-7416	Concrete Hardware Kit
360039-7417	Glue Down Anchor Plate Kit

⚠️ **WARNING:** Cancer and reproductive harm - www.P65Warnings.ca.gov

*Available only to customers in USA

Wheel Chocks

Ergonomic Handle Wheel Chocks*

Reinforced rubber resists tearing, abrasion and ozone weathering. Rubber provides a sure grip on virtually any surface.



Part Number	Type	Dimensions
360039-1219	Laminated Rubber	9.5" x 5.5" x 10"
360039-1335	Orange Molded Rubber Chock	9.25" x 6" x 8"
360039-1689	Black Molded Rubber Chock	9.25" x 6" x 8"
360039-875	Fabricated Steel	10" x 8.25" x 9.5"
360039-876	Fabricated Steel	8" x 9" x 10.75"

⚠️WARNING: Cancer and reproductive harm - www.P65Warnings.ca.gov

Rail Chocks*

Single steel rail chock design fits most standard size rails. Heavy-duty welded steel construction provides maximum durability & strength. Rubber hand grips included for a non-slip grip.



Part Number	Type
360039-5885	Single Rail Chock/Flag Rail Chock Combo
360039-5886	Single Rail Chock/Single Rail Chock Combo

⚠️WARNING: Cancer and reproductive harm - www.P65Warnings.ca.gov

*Available only to customers in USA

Chain & Hanger Kit (15')*

Part Number - 360039-007

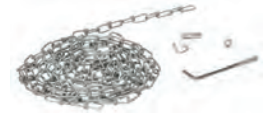

⚠️WARNING: Cancer and reproductive harm - www.P65Warnings.ca.gov

Jacks

Continued ▶

Trailer Stability Jack*

Used to prevent up-ending semi-trailers when they are not connected to a tractor during loading and unloading operations. Features: High strength steel construction. Reflective collar increases visibility at night. Unique design levels trailers parked on sloped ground. Powder-coat safety yellow. Handle color may vary. Meets OSHA regulations when used with wheel chocks.



Part Number	Description	Static Capacity (lbs)	Lifting Capacity (lbs)	Service Range	Wheel Size & Type	Wt. (lbs)
360039-045	Economy (Rounded Base)	50,000	5,000	44" to 51"	None	39
360039-085	Economy	50,000	5,000	44" to 51"	None	39
360039-084	Economy (Flat Base)	50,000	5,000	44" to 51"	None	44
360039-074	Economy	50,000	5,000	41" to 57.5"	8" hard rubber	102
360039-067	Ratchet	100,000	40,000	45" to 57"	10" hard rubber	141
360039-068	Ratchet Jack	100,000	40,000	39" to 51"	10" hard rubber	137
360039-075	Spin Top	100,000	40,000	39.5" to 51"	10" hard rubber	129
360039-086	Big Foot Stabilizing Jack	100,000	40,000	39.5" to 51"	10" hard rubber	162
360039-087	Ratchet Beam Jack	100,000	40,000	40" to 51"	10"x2" hard rubber	182
360039-088	Spin Top Beam	100,000	40,000	40" to 51"	10"x2" hard rubber	200
360039-089	Hydraulic Beam Jack	100,000	40,000	41" to 47"	10"x2" hard rubber	175
360039-090	Hand Crank	100,000	50,000	41" to 55"	16" Solid Foam	238
360039-091	Hand Crank	100,000	50,000	41" to 55"	16" fully pneumatic	221

⚠️WARNING: Cancer and reproductive harm - www.P65Warnings.ca.gov

*Available only to customers in USA

Jacks

Trailer Jack*

Use for a wide variety of leveling and adjustment applications. Ideal for industrial or agricultural equipment trailers. Bracket attaches in a variety of ways in order to meet needs.



Part Number	Type	Capacity
360039-2000	Tube Ring	2000 lbs.

⚠️WARNING: Cancer and reproductive harm - www.P65Warnings.ca.gov

Mechanical Machinery Jack*

Compact design with collapsible lever. Self-locking, anti-kickback operating lever. Lifting and lowering speeds are controllable for easy operation. Will not drift down even after an extended period of time.



Part Number	Capacity (tons)
360039-1278	1.5
360039-1279	3
360039-1277	5

⚠️WARNING: Cancer and reproductive harm - www.P65Warnings.ca.gov

Mechanical Screw Jack*

Mechanical screw jack is for loading dock equipment. Acme thread post supports the load.



Part Number	Capacity (tons)
360039-1306	3
360039-1307	5
360039-1304	10
360039-1305	20

⚠️WARNING: Cancer and reproductive harm - www.P65Warnings.ca.gov

Heavy Duty Ratchet Farm Jack - 3.5 Ton Capacity*

Farm jack design lifts, pulls, and pushes heavy machinery and objects. Hydraulic free with full lever mechanical operation. Heavy-duty ratchet operating lever.



Part Number	Raised Height
360039-1018	42"
360039-1019	53"

⚠️WARNING: Cancer and reproductive harm - www.P65Warnings.ca.gov

Cargo Bar*



Part Number	Description
360039-060	Aluminum - 1 Piece Heavy Duty
360039-061	Steel - 1 Piece With Hoops
360039-062	Galvanized Steel- 1 Piece
360039-063	Galvanized Steel - 2 Piece Folding
360039-064	Galvanized - 2 Piece Telescopic

⚠️WARNING: Cancer and reproductive harm - www.P65Warnings.ca.gov

Steel Prylever Bars - 5000 lb. Capacity*

Prylever bar design provides needed leverage. Thick steel nose plate with beveled edge. Poly-on-steel wheels. Powder-coated steel construction.

Part Number	Length
360039-5516	5'
360039-5517	6'
360039-5518	7'



⚠️WARNING: Cancer and reproductive harm - www.P65Warnings.ca.gov

Wood Prylever Bars - 4250 lb. Capacity*

Prylever bar design provides needed leverage. Thick steel nose plate with beveled edge. Poly-on-steel wheels.

Part Number	Length
360039-5519	5'
360039-5520	6'
360039-5521	7'



⚠️WARNING: Cancer and reproductive harm - www.P65Warnings.ca.gov

Stable Jack Notice Sign*

Part Number - 360039-092



⚠️WARNING: Cancer and reproductive harm - www.P65Warnings.ca.gov

Drivers Instruction Sign*

Part Number - 360039-093



⚠️WARNING: Cancer and reproductive harm - www.P65Warnings.ca.gov

*Available only to customers in USA

Hand Trucks

P-Handle Hand Trucks*

The P-Handle Hand Truck is ideal for transporting heavy and awkward loads. This truck works well for the user that needs to free up one hand. The "P" shaped handle makes the truck easy to steer and maneuver.



360039-229



360039-228



360039-1830



360039-1831



360039-1827



360039-1833

Part Number	Description	Capacity (lbs.)
360039-229	Aluminum - Hard Rubber Wheels	500
360039-228	Aluminum - Pneumatic Wheels	500
360039-1830	Steel - Pneumatic Wheels	600
360039-1831	Steel - Hard Rubber Wheels	600
360039-1833	Stainless Steel - Pneumatic Wheels	500
360039-1827	Stainless Steel - Hard Rubber Wheels	600

WARNING: Cancer and reproductive harm - www.P65Warnings.ca.gov

*Available only to customers in USA



Personal Hand Truck

Part Number - 322300-001

150 lb. load capacity. Opens and closes in seconds. Extends to 39" tall. Compacts to 25" tall and 2.5" thick. 15" wide aluminum base plate. 5" rubber wheels. No assembly required. Weight: 7.2 lbs.



Personal Hand Truck

Part Number - 322300-002

200 lb. load capacity. Opens and closes in seconds. Extends to 39" tall. Compacts to 28.5" tall and 2.5" thick. Extra wide 19.25" aluminum base plate. Rugged 22mm steel frame. 7" rubber wheels. No assembly required. Weight: 10.5 lbs.

CROWN

one source
LIFT TRUCK PARTS

Pallet Jack Wheel Kits Quick, Easy Replacements For Your Mixed Fleet

- Everything you need in one kit
- Bearings assembled in wheels/rollers
- Kits available for both load wheels and load/steer wheels
- Support for multiple brands including Hyster, Raymond, Toyota, Yale, Big Joe and Mighty Lift



See Wheels and Tires Section

Self-Dumping Hoppers with Bumper Release*

Automatically dumps when cushioned bumper release contacts front of the dumpster. Must be attached to fork truck when dumping. Safety restraint is provided to secure the hopper to the fork truck. Cable included to manually dump hopper from seat of truck. Returns to upright and locked position when lowered to the ground. Usable fork pockets measure 7"W x 2"H. Color: Blue. Powder Coat Paint. Additional colors are available.

D Style*

Part Number	Volume		Overall (W x L x H)	Fork Pocket Centers	Wt. (lbs)
	Cubic Yards	Capacity (lbs)			
Light Duty - 12 Gauge Steel					
360039-7048	¼	2,000	26" x 51 ⁷ / ₈ " x 38"	18"	335
360039-7054	⅓	2,000	26" x 51 ⁷ / ₈ " x 38"	18"	340
360039-7058	½	2,000	33 ¹ / ₁₆ " x 51 ³ / ₄ " x 38"	18"	365
360039-7061	¾	2,000	31 ¹ / ₁₆ " x 61 ¹ / ₈ " x 42 ¹ / ₁₆ "	18"	449
360039-7036	1	2,000	41 ¹ / ₁₆ " x 61 ¹ / ₈ " x 42 ¹ / ₁₆ "	18"	479
360039-7039	1½	2,000	43 ¹ / ₁₆ " x 68 ⁵ / ₁₆ " x 51 ¹³ / ₁₆ "	28"	565
360039-7042	2	2,000	56 ¹ / ₁₆ " x 68 ⁵ / ₁₆ " x 51 ¹³ / ₁₆ "	28"	613
360039-7045	2½	2,000	69 ⁹ / ₁₆ " x 68 ³ / ₈ " x 51 ³ / ₄ "	28"	863
360039-7051	3	2,000	81 ³ / ₄ " x 68 ³ / ₈ " x 51 ¹³ / ₁₆ "	28"	940
Medium Duty - 10 Gauge Steel					
360039-7049	¼	4,000	26" x 51 ⁷ / ₈ " x 38 ¹ / ₁₆ "	18"	397
360039-7055	⅓	4,000	26" x 51 ⁷ / ₈ " x 38 ¹ / ₁₆ "	18"	397
360039-7059	½	4,000	33 ³ / ₁₆ " x 51 ⁵ / ₈ " x 38 ¹ / ₁₆ "	18"	435
360039-7062	¾	4,000	31 ¹ / ₁₆ " x 61 ¹ / ₈ " x 42 ³ / ₄ "	18"	543
360039-7037	1	4,000	41 ¹ / ₂ " x 61 ¹ / ₈ " x 42 ¹ / ₁₆ "	18"	534
360039-7040	1½	4,000	43 ¹ / ₁₆ " x 68 ³ / ₈ " x 51 ¹³ / ₁₆ "	28"	714
360039-7043	2	4,000	56 ⁵ / ₈ " x 68 ³ / ₈ " x 51 ¹³ / ₁₆ "	28"	701
360039-7046	2½	4,000	69 ⁹ / ₁₆ " x 68 ³ / ₈ " x 51 ³ / ₄ "	28"	863
360039-7052	3	4,000	81 ³ / ₄ " x 68 ³ / ₈ " x 51 ¹³ / ₁₆ "	28"	940
Heavy Duty - 8 Gauge Steel					
360039-7047	¼	6,000	26" x 51 ⁷ / ₈ " x 38 ¹ / ₁₆ "	18"	397
360039-7053	⅓	6,000	26" x 51 ⁷ / ₈ " x 38 ¹ / ₁₆ "	18"	397
360039-7057	½	6,000	33 ³ / ₁₆ " x 51 ⁵ / ₈ " x 38 ¹ / ₁₆ "	18"	435
360039-7060	¾	6,000	31 ¹ / ₁₆ " x 61 ¹ / ₈ " x 42 ³ / ₄ "	18"	543
360039-7035	1	6,000	41 ¹ / ₁₆ " x 61 ¹ / ₈ " x 42 ³ / ₄ "	18"	572
360039-7038	1½	6,000	43 ¹ / ₁₆ " x 68 ³ / ₈ " x 51 ¹³ / ₁₆ "	28"	714
360039-7041	2	6,000	56 ¹ / ₁₆ " x 68 ³ / ₈ " x 51 ¹³ / ₁₆ "	28"	767
360039-7044	2½	6,000	69 ⁹ / ₁₆ " x 68 ³ / ₈ " x 51 ³ / ₄ "	28"	863
360039-7050	3	6,000	81 ³ / ₄ " x 68 ³ / ₈ " x 51 ¹³ / ₁₆ "	28"	940
360039-7056	3½	6,000	64 ¹ / ₄ " x 79 ³ / ₈ " x 64 ³ / ₈ "	28"	1128
360039-3743	4	6,000	72 ¹⁵ / ₁₆ " x 79 ³ / ₈ " x 64 ³ / ₈ "	28"	1445



360039-7051



360039-7043



360039-7056

⚠ **WARNING:** Cancer and reproductive harm - www.P65Warnings.ca.gov

H Style - Low Profile 90 degrees*

Part Number	Volume		Overall (W x L x H)	Fork Pockets	Wt. (lbs)
	Cubic Yards	Capacity (lbs)			
360039-7102	1	2,000	51" x 51 ¹ / ₁₆ " x 28 ¹ / ₈ "	21 ⁵ / ₈ "	311
360039-7103	1	4,000	51" x 51 ¹ / ₁₆ " x 28 ¹ / ₈ "	21 ⁵ / ₈ "	362
360039-7101	1	6,000	51" x 51 ¹ / ₄ " x 28 ³ / ₁₆ "	21 ⁵ / ₈ "	398
360039-7105	1½	4,000	51" x 56 ³ / ₁₆ " x 38 ⁵ / ₈ "	21 ⁵ / ₈ "	435
360039-7104	1½	6,000	51" x 56 ¹ / ₂ " x 38 ¹ / ₁₆ "	21 ⁵ / ₈ "	472



360039-7105

⚠ **WARNING:** Cancer and reproductive harm - www.P65Warnings.ca.gov

Portable Steel Hoppers*

Includes: foot operated caster lock, cable to manually dump hopper from seat of truck, and handle for transporting. Units must be attached to fork truck when dumping. Usable fork pockets measure 7"W x 2"H. Color: Blue. Powder Coat Paint.

Part Number	Volume		Overall (W x L x H)	Fork Pockets	Wt. (lbs)
	Cubic Yards	Capacity (lbs)			
360039-5505	½	2,000	34 ¹³ / ₁₆ " x 53 ⁷ / ₈ " x 37 ³ / ₁₆ "	21 ⁵ / ₈ "	262
360039-5506	1	2,000	58 ¹³ / ₁₆ " x 53 ³ / ₈ " x 37 ¹ / ₈ "	21 ⁵ / ₈ "	389
360039-5507	1½	2,000	58 ¹³ / ₁₆ " x 58 ¹⁵ / ₁₆ " x 47 ⁵ / ₈ "	21 ⁵ / ₈ "	440



360039-5505

⚠ **WARNING:** Cancer and reproductive harm - www.P65Warnings.ca.gov

*Available only to customers in USA

Hoppers

Low Profile Parts Hopper*

The low profile design allows the hoppers to be placed underneath machinery as a catch basin for parts. Must be attached to fork truck when dumping. Returns to upright and locked position when lowered to the ground. Usable fork pockets measure 7"W x 2"H. Includes removable push handle. Color: Blue. Powder Coat Paint.



Part Number	Volume Cubic Yards	Capacity (lbs)	Overall (W x L x H)	Fork Pockets	Wt. (lbs)	
360039-4736	1/3	2,000	29 ¹ / ₁₆ " x 54" x 33 ⁵ / ₁₆ "	11 ¹ / ₂ "	199	(3) wheels: (2) rigid and (1) swivel with brake
360039-4735	1/2	2,000	48 ⁷ / ₁₆ " x 54 ¹ / ₁₆ " x 34"	21 ¹ / ₂ "	340	(4) wheels: (2) rigid, (1) swivel and (1) swivel with brake

▲ **WARNING:** Cancer and reproductive harm - www.P65Warnings.ca.gov

Casters for Self-Dumping Hoppers*

Transport loads with portable hoppers. The maximum weight capacity is the lowest weight capacity of either the hopper or the caster. Weight of hopper must be considered when calculating usable capacity. Sets include (2) rigid and (2) swivel casters. For the H series 1/4 and 1/2 cubic yard hoppers only (3) casters included: (2) rigid and (1) swivel, and bolt on stabilizing legs for the back. Casters are bolted on by utilizing the factory stamped hole in the fork tubes. Casters are shipped uninstalled to prevent freight damage.

Part Number	For Use With Hopper Style	Caster Size	Uniform Capacity	Caster Description	Qty per Order	Wt. (lbs)
H Style						
360039-7219	H	6" X 2"	1,800 lb.	Mold-on-Rubber	3	25
360039-7222	H	6" X 2"	2,400 lb.	Mold-on-Rubber	4	28
360039-7218	H	6" X 2"	3,600 lb.	Semi-Steel	3	27
360039-7220	H	6" X 2"	3,600 lb.	Poly-on-Steel	3	26
360039-7353	H	6" X 2"	3,600 lb.	Glass Filled Nylon	3	17
360039-7221	H	6" X 2"	4,800 lb.	Semi-Steel	4	31
360039-7223	H	6" X 2"	4,800 lb.	Poly-on-Steel	4	30
360039-7355	H	6" X 2"	4,800 lb.	Glass Filled Nylon	4	18
360039-7354	H	6" X 2"	6,000 lb.	Ductile Steel	3	35
360039-7356	H	6" X 2"	8,000 lb.	Ductile Steel	4	42

Note: Maximum caster diameter permitted is 6". Added height to hopper for 6" casters is 3³/₄".

D Style						
360039-7226	D	6" X 2"	2,400 lb.	Mold-on-Rubber	4	29
360039-7224	D	6" X 2"	4,800 lb.	Semi-Steel	4	32
360039-7228	D	6" X 2"	4,800 lb.	Poly-on-Steel	4	31
360039-7357	D	6" X 2"	4,800 lb.	Glass Filled Nylon	4	19
360039-7359	D	6" X 2"	8,000 lb.	Ductile Steel	4	43
360039-7227	D	8" X 2"	2,400 lb.	Mold-on-Rubber	4	37
360039-7225	D	8" X 2"	4,800 lb.	Semi-Steel	4	42
360039-7229	D	8" X 2"	5,000 lb.	Poly-on-Steel	4	42
360039-7358	D	8" X 2"	5,000 lb.	Glass Filled Nylon	4	22

Note: Maximum caster diameter permitted is 8". Added height to hopper for 6" casters is 7¹/₂" and for 8" casters is 9¹/₂".

▲ **WARNING:** Cancer and reproductive harm - www.P65Warnings.ca.gov



360039-7357

Heavy Duty Poly Lids for D&H Series Hoppers*

Heavy-duty virgin polyethylene material. Lightweight and easy to open. Includes a crown for water drainage and a ribbed design for strength.

Part Number	For Use With Hopper Size	For Use With Hopper Style	Number of Pieces	Wt. (lbs)
360039-7146	1/2	H	1	57
360039-7342	1	H	2	56
360039-7343	1 1/2	H	2	61
360039-7344	1/4	D	1	56
360039-7345	1/3	D	1	57
360039-7346	1/2	D	1	57
360039-7347	3/4	D	1	58
360039-7348	1	D	1	57
360039-7349	1 1/2	D	1	58
360039-7350	2	D	2	59
360039-7351	2 1/2	D	2	59
360039-7352	3	D	2	61

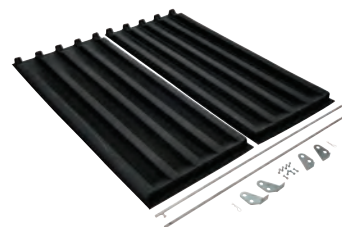

360039-7350

▲ **WARNING:** Cancer and reproductive harm - www.P65Warnings.ca.gov

*Available only to customers in USA

Warehouse 3.17

Dockboards

Aluminum Truck Dockboards with Steel Safety Curbs*

High-strength aluminum treadplate material. Zinc-plated locking legs are within OSHA compliance. Beveled entrance and exit edges. Heavy-duty steel curbs are painted yellow, bolted to deckplate. Capacity is based upon the heaviest type of equipment used plus the maximum load carried times the single axle rating of total load.

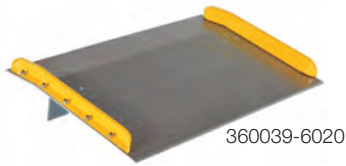

360039-6020

10,000 lb. capacity

Part Number	Dimensions
360039-6024	60" x 36"
360039-6025	60" x 48"
360039-6026	60" x 60"
360039-6027	60" x 72"
360039-6028	72" x 36"
360039-6029	72" x 48"
360039-6030	72" x 60"
360039-6031	72" x 72"

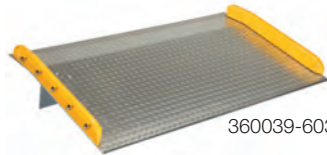

360039-6032

15,000 lb. capacity

Part Number	Dimensions
360039-6036	60" x 36"
360039-6037	60" x 48"
360039-6038	60" x 60"
360039-6039	60" x 72"
360039-6040	72" x 36"
360039-6041	72" x 48"
360039-6042	72" x 60"
360039-6043	72" x 72"

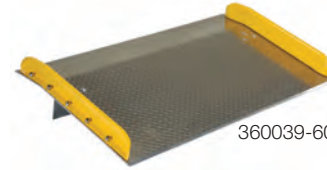

360039-6044

20,000 lb. capacity

Part Number	Dimensions
360039-6044	60" x 36"
360039-6045	60" x 48"
360039-6046	60" x 60"
360039-6047	60" x 72"
360039-6048	72" x 36"
360039-6049	72" x 48"
360039-6050	72" x 60"
360039-6051	72" x 72"

⚠️WARNING: Cancer and reproductive harm - www.P65Warnings.ca.gov

Fabricated Aluminum Hose & Cable Crossovers*

Aluminum construction. Unique design protects wires and cords from traffic wear and tear. Tread plate. Lightweight design. All welded.

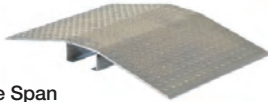

360039-4377

Part Number	Overall Size	Usable Span
360039-4377	24" x 36"	4" x 3"
360039-4378	24" x 36"	4" x 4"
360039-4379	24" x 40"	8" x 3"
360039-4380	24" x 40"	8" x 4"
360039-4381	24" x 44"	12" x 3"
360039-4382	24" x 44"	12" x 4"
360039-4383	24" x 48"	16" x 3"
360039-4384	24" x 48"	16" x 4"
360039-4385	48" x 36"	4" x 3"
360039-4386	48" x 36"	4" x 4"
360039-4387	48" x 40"	8" x 3"
360039-4388	48" x 40"	8" x 4"
360039-4389	48" x 44"	12" x 3"
360039-4390	48" x 44"	12" x 4"
360039-4391	48" x 48"	16" x 3"
360039-4392	48" x 48"	16" x 4"

⚠️WARNING: Cancer and reproductive harm - www.P65Warnings.ca.gov

Tubes

Bicycle/Tricycle Tubes

Part Number - 305006
24" x 2.125"

▼ OEM Reference

Part Number - 305007
26" x 2.125"

▼ OEM Reference
Summit 26x2.125
GRNG 2KGH3



*Available only to customers in USA

Floor Mats



Note: see Tools Section, page 9.04, for Crown Bar Stools.



Crown Branded Mats

Part Number	Size
368200-001	2' x 3'
368200-002	3' x 5'
368200-003	4' x 6'
368200-004	3' x 10'

Use the Crown branded mats to make a lasting impression to your customers. Static dissipative nylon yarn treated with StainStopper™ Technology. 100% nitrile rubber backing for increased slip and resistance. Certified High-Traction by the National Floor Safety Institute.

Tough Rib Floor Mat

Dirt-trapping design is uniquely built for heavy-traffic and high soil areas. Extra coarse polypropylene fibers stand up to demanding use. Vinyl backing and borders. Can be cleaned by vacuuming, sweeping or hosing.

Part Number	Size	Color
368200-202	3' x 5'	Charcoal
368200-203	4' x 6'	Charcoal
368200-204	3' x 10'	Charcoal



Tire Tuff Royale High-Traffic Entrance Mat

Heavyweight floor mat designed for busy traffic areas – inside or out. Crush-resistant bi-level surface removes debris and moisture from passing shoes. Dual-fiber needle-punch mats dry quickly and resist staining and fading. Molded rubber backing for durability. Product contains 50% total recycled content.

Part Number	Size	Color
368200-302	3' x 5'	Onyx

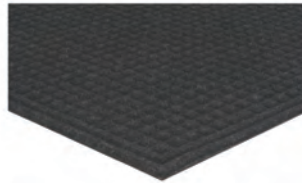

Unifirst Great Impressions 2.0 Walk-Off Floor Mat

Heavy-duty, nylon-tufted mat with stay-put "hugger" backing. Dense rubber back helps mat stay in place, reduce flex and improve durability. Absorbent surfaces trap and hold up to a gallon of water per square yard. Heavier weight helps hold mat in place and reduce potential for "flip-ups".

Part Number	Size	Color
368200-102	3' x 5'	Grey
368200-103	4' x 6'	Grey
368200-104	3' x 10'	Grey





Power Unit 24V with Lift and Steer

Part Number	Where Used
B02-05-0034	Telescopic Masts ESP 19



10" Drive Tire

Part Number	Where Used
B08-02-0029	Telescopic Masts ESP 19



Joysticks

Part Number	Where Used	Additional Info
B01-10-0281	Telescopic Masts ESP 19	Assembly- Esp Rev 2
B01-10-0264	Telescopic Masts ESP 19	With Enable Single Axis
E-00553	Telescopic Masts ESP 19	Esp Gen 4



8" Steer Tire

Part Number	Where Used
B08-02-0026	Telescopic Masts ESP 19



Starter Solenoid-24VDC-200AMP

Part Number	Where Used
B02-15-0425	Telescopic Masts ESP 19



Motor 24VDC

Part Number	Where Used
B02-15-0424	Telescopic Masts ESP 19



Retractable Cord 16-3 Yeltpc with Plugs

Part Number	Where Used
B01-01-0143	Telescopic Masts ESP 19



Cylinders

Part Number	Where Used	Additional Info
B02-03-0038	Telescopic Masts ESP 19	1½" x 4" x ½" Steering



Potentiometer

Part Number	Where Used
2505007020	Telescopic Handlers HTL4017 / HTL9055, Telescopic Handlers HTL4014 / HTL9045, Telescopic Handlers HTL4010, Telescopic Handlers HTL3617 / HTL8055, Telescopic Handlers HTL3614 / HTL8045, Telescopic Handlers HTL3510, Telescopic Handlers HTL3210, HTL5210 / HTL11532, HTL3010



Battery Charger 12V/25A Gas and Float

Part Number
B01-05-0055



Switches

Part Number	Where Used	Additional Info
B01-03-0065	Telescopic Masts ESP 19	No Push Button with Plug
B01-02-0082	Telescopic Masts ESP 19	Keyed Selector



Wheels

Part Number	Description
E-00413	10" x 4" x 8", Gray
E-00437	12" x 4" x 10", Gray, Non-Marking, ESP



Key

Part Number	Where Used
S104466000	Towed Platforms HTT13PX / 3632T, Towed Platforms HTA16P / 4527A, Telescopic Masts ESP 19

Biljax OEM Parts



Clevis Pin

Part Number	Additional Info
E-00512	6½" x ¾"



Knuckle Plate

Part Number	Where Used
B07-08-0037	Telescopic Masts ESP 19



0090-0420 0090-0428 0090-0425 0090-0574

Washers

Part Number	Where Used	Additional Info
0090-0420	Towed Platforms HTA22P / 6543A, Telescopic Masts ESP 19, Electric Articulated Platforms HLA19PX / 55XA	Flat, 5/16", Zinc, SAE
0090-0428	Telescopic Masts ESP 19	Flat, 3/4", Zinc, SAE
0090-0425	Towed Platforms HTT13PX / 3632T, Towed Platforms HTA22P / 6543A, Towed Platforms HTA19P / 5533A, Towed Platforms HTA16P / 4527A, Towed Platforms HTA13P / 3522A, Telescopic Masts ESP 19	Flat, 5/8", Zinc, SAE
0090-0574	Telescopic Masts ESP 19	Flat, 1/2", Zinc, SAE



0090-0185 0090-0188 0096-0044

Self-Locking Nuts

Part Number	Where Used	Additional Info
0090-0185	Towed Platforms HTT13PX / 3632T, Towed Platforms HTA22P / 6543A, Towed Platforms HTA19P / 5533A, Towed Platforms HTA16P / 4527A, Towed Platforms HTA13P / 3522A, Telescopic Masts ESP 19, Electric Articulated Platforms HLA19PX / 55XA, Electric Articulated Platforms HLA16PX / 45XA	5/16-18
0090-0188	Telescopic Masts ESP 19	3/8-16, Nylon
0096-0044	—	—



0090-1061 0090-1137 0090-0046



0090-0001 0096-0012

Cap Screws

Part Number	Where Used	Additional Info
0090-1061	Telescopic Masts ESP 19	5/16-18 x 2
0090-1137	Telescopic Masts ESP 19	3/8-16 UNC x 3
0090-0046	Telescopic Masts ESP 19	3/8-16 x 1 3/4
0090-0001	Telescopic Masts Belone 800/900/1100	1/4-20 x 1/2
0096-0012	Towed Platforms Htt13Px / 3632T	Flat Head, M8 x 25 mm



Bushing

Part Number	Where Used
A-00056	Towed Platforms HTT13PX / 3632T, Towed Platforms HTA22P / 6543A, Towed Platforms HTA16P / 4527A, Towed Platforms HTA13P / 3522A, Electric Articulated Platforms HLA19PX / 55XA, Electric Articulated Platforms HLA16PX / 45XA

Battery 12CE100 Type S Genie

Part Number	Additional Info
345012-100-SS	Aluminum Dry Battery, 12V GRP 27, 100 AH, Dimensions: 12.09L x 6.65W x 8.31H



⚠ WARNING: Cancer and reproductive harm - www.P65Warnings.ca.gov

Two Switch Silicon Boot

Part Number
GN229093GT



⚠ WARNING: Cancer and reproductive harm - www.P65Warnings.ca.gov



GN105454GT GN105122GT GN57998GT

Wheel and Tire Assembly

Part Number	Additional Info
GN105454GT	15", Gray Non-Marking
GN105122GT	12", Gray Non-Marking
GN57998GT	10" x 3", Gray, Mould On, Non-Marking

⚠ WARNING: Cancer and reproductive harm - www.P65Warnings.ca.gov

Brush Power Unit

Part Number	Additional Info
GN44751GT	Four Required For Replacement



⚠ WARNING: Cancer and reproductive harm - www.P65Warnings.ca.gov

Rubber Latch

Part Number	Additional Info
GN57881GT	3 ¹³ / ₃₂ x 1 ¹ / ₈



⚠ WARNING: Cancer and reproductive harm - www.P65Warnings.ca.gov

CCW Gear Pump, 4CC

Part Number
GN231572GT



⚠ WARNING: Cancer and reproductive harm - www.P65Warnings.ca.gov

Gas Shock Scissors

Part Number
GN39542GT



⚠ WARNING: Cancer and reproductive harm - www.P65Warnings.ca.gov



GN78903GT GN137634GT GN62161GT

Joystick Controllers

Part Number	Additional Info
GN78903GT	Single Axis, Hall Effect Joystick
GN137634GT	Single Axis, Hall Effect Joystick
GN62161GT	—

⚠ WARNING: Cancer and reproductive harm - www.P65Warnings.ca.gov

Limit Switch with Roller Arm

Part Number
GN96948GT



⚠ WARNING: Cancer and reproductive harm - www.P65Warnings.ca.gov

Gen 5 Coil Cord Kit

Part Number
GN144065GT

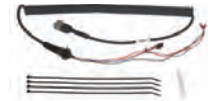

⚠ WARNING: Cancer and reproductive harm - www.P65Warnings.ca.gov

Spring Rewind Cord Reel

Part Number
GN218073GT



⚠ WARNING: Cancer and reproductive harm - www.P65Warnings.ca.gov

Coil Cord-Joystick Slabs

Part Number
GN62223GT



⚠ WARNING: Cancer and reproductive harm - www.P65Warnings.ca.gov

Hinge, Spring, Long Leg

Part Number
GN104804GT



⚠ WARNING: Cancer and reproductive harm - www.P65Warnings.ca.gov

Solenoid Manual Valve

Part Number
GN66465GT



⚠ WARNING: Cancer and reproductive harm - www.P65Warnings.ca.gov

5" Link Bumper

Part Number
GN96735GT



⚠ WARNING: Cancer and reproductive harm - www.P65Warnings.ca.gov

Non-Skid Die Cut Tape

Part Number	Description
GN47098GT	4" x 40"
GN47374GT	4" x 32"



GN47098GT

GN47374GT

⚠ WARNING: Cancer and reproductive harm - www.P65Warnings.ca.gov

Genie OEM Parts

Blue Aerial Operator Access Card

Part Number
GN76754-10GT



⚠️ **WARNING:** Cancer and reproductive harm - www.P65Warnings.ca.gov

Aerosol Paint

Part Number	Description
GN1268GT	Genie Gray
GN1484GT	Bright Blue



GN1268GT GN1484GT

⚠️ **WARNING:** Cancer and reproductive harm - www.P65Warnings.ca.gov

Keys

Part Number	Additional Info
GN83093GT	Single Key
S104466000	Single Key
GN96011GT	Keyswitch Kit



⚠️ **WARNING:** Cancer and Reproductive Harm - www.P65Warnings.ca.gov

Decals

Part Number	Description
GN82561GT	Use Safety Arm Danger Decal
GN44737GT	Tip-Over Trays Danger Decal



GN82561GT



GN44737GT

⚠️ **WARNING:** Cancer and reproductive harm - www.P65Warnings.ca.gov

Power Cords

Part Number	Description
GN100195GT	79" Power Cord, US 110
GN55021GT	9" Power Cord, US 110



⚠️ **WARNING:** Cancer and Reproductive Harm - www.P65Warnings.ca.gov

Pallet Jack Wheel Kits

Expanded truck brands now available!

Manual Pallet Jacks:



- Eagle
- Harbor Freight
- Jungheinrich
- Pramac
- Raymond
- Rol-Lift
- Total Source
- Vestil
- Yale

Electric Pallet Jacks:

- Baker
- Barrett
- Blue Giant
- CAT
- Mitsubishi
- MULTITON
- Nissan
- Unicarriers



See the Wheels and Tires Section for a complete listing

one source
LIFT TRUCK PARTS



Crown is Your One-Stop Shop

Fall Protection Equipment

Including harnesses and lanyards

Safety Apparel

Including ear and eye protection, face shields, safety vests, coveralls and hard hats

Respiratory Equipment

Including respirators and masks

Seat Belts

Including retractable belts, high visibility safety orange and standard color belts in a variety of lengths and styles

First Aid Kits

Including those for minor injuries and high risk work zones

See Safety Equipment Section



WAREHOUSE

Planned Maintenance and Tune-Up Kits for IC Forklifts



We stock the parts you need most



PLANNED MAINTENANCE KITS



TUNE-UP KITS

A time-saving solution for completing important routine maintenance. Kits help streamline the ordering and inventory process by combining all of the necessary components under a single part number. Kits are available for IC forklifts and engine types from a wide variety of manufacturers.

See IC Truck Components Section

Section 4

Electric Truck Components

Contents

Replacement Bulbs	4.02
Lights	4.03
Warning Devices	4.06
Deutsch Connectors	4.11
GE Plug Kits	4.11
Grounding Straps	4.12
Switches	4.12
Lift Truck Power Switch Keys	4.18
Wire and Cable	4.19
Fuses	4.20
Contactors/Contactor Tips	4.24
Cards	4.27
DC/DC Converters	4.29
Solenoids	4.30
Battery Capacity Indicators & Hour Meters	4.31
Yale, Hyster, Raymond Parts Breakdown	4.33-4.35, 4.48-4.49
Lift Structure	4.36
Drive Unit, Brake, and Steering	4.50
Motor and Hydraulic	4.57
Cylinders/Seal Kits	4.68
Miscellaneous	4.69

New Items:

Lift Truck Power Switch Keys - p. 4.18
Power Cable 100 Ft Reel - p. 4.19

Note: 1910.178(q)(5) (1998) of the Occupational Safety and Health Act (OSHA) requires that "All parts of any such industrial truck requiring replacement shall be replaced only by parts equivalent as to safety with those used in the original design."

The installation onto a lift truck of non-certified electronic components may invalidate a truck's UL EE or LPS listing and could pose a safety risk. Customers with UL-listed lift trucks are solely responsible for ensuring compliance with UL for field modifications. The selection of non-OEM parts is made solely by the customer with the awareness that OEM parts are available. Crown Equipment Corporation is unaware of what testing and/or certification, if any, the non-OEM parts have undergone and disclaims all warranties and representations regarding any non-OEM part.



Replacement Bulbs

Part Number	Voltage	Number of Elements	Number of Contacts	Bulb Part Number	Series
Single and Dual Element					
110578	12	1	1	93	Stockpickers
116364	12	1	1	1141	RR/RD3, RR/RD5
110581	12	1	1	1156	Stockpickers, FC/FP, TSEV100
H49784-573	12	1	1	1156, LED	Stockpickers, FC/FP, TSEV100
122232	12.8	1	2	1142	FC
112480	12.8	1	2	1157	FC
101365	28	1	1	1683	TSEV100
083307	24	1	1	3011	SP36, SP42, SP48, TS
078533-001	28	1	2	1638	Stockpickers, FC/FP, PE4
118321	38	1	1	SP7	FC/FP
370338	36	2	2	3036-25	
117993 ⚠	38	1	2	SP1	FC/FP, FC4, SC4
101957 ⚠	38	2	2	SP5	Turrets, RC, SC
118322	50	1	1	SP8	FC/FP, RC3
117994	50	1	2	SP2	FC, FC4
105491	50	1	2	SP6	TSP

Part Number	Vdc	Current	Watts
LED Bipolar DC			
370655	12-14	0.03	0.45

Part Number	Voltage	Bulb Part Number	Series
Small with Short Base			
086042-001	14	386	RR, RD, RS, RR and RD Heated Cab, TS
087227	24	1819	PC, PE, PR, PW, RC, RR/RD/RS, RC, SC, SP36, SP42, SP48, W(HD), WB, WR

Sealed Beam (102 mm/4 in)	Diameter	
340002-001	12	4411
346957	12-24	
146957 ⚠	10-60	
087195-001	28	4589
102195	36	4350
105619 ⚠	48	4340

LED sealed beam is a direct replacement for part numbers 340002-001 & 087195-001
 LED sealed beam is a direct replacement for part numbers 340002-001, 087195-001, 102195 & 105619
 Reach Trucks, Stockpickers
 Reach Trucks, Turrets, FC 4000, RC, RC 3000, SC, SC 4000
 TSP

Small with Long Base			
105816	36	1822	TSP, TSev100, SP 3000

Long with Dual Contacts			
111382	12	211-2	FC

Xenon Flashtube - Strobe			
340009	12-80	5001	RR 5000

Bulb with Plug, Halogen			
125672	12.8	862	FC/FP, FC 4000, PE 4000

Flashtube - Strobe			
111782 ⚠		400-537	TSP 6000

Bulb with Wire	Specs	Series	Wattage	Warranty
340108	10-30	H-3 LED		3 years
112481	12.8	H-3	FC	55
380030-160	12	H-3		55
796059-005	24	H-3	ESR 4500	70
340080	36	H-3		35
340075	48	H-3		55

Fluorescent Bulb	Specs
370576	58 9" Length; Wattage: 18

Base with Bulb	
370744	Used on Caterpillar, Clark, Hyster, Mitsubishi, Yale oval work light

⚠ **WARNING:** Cancer and reproductive harm - www.P65Warnings.ca.gov

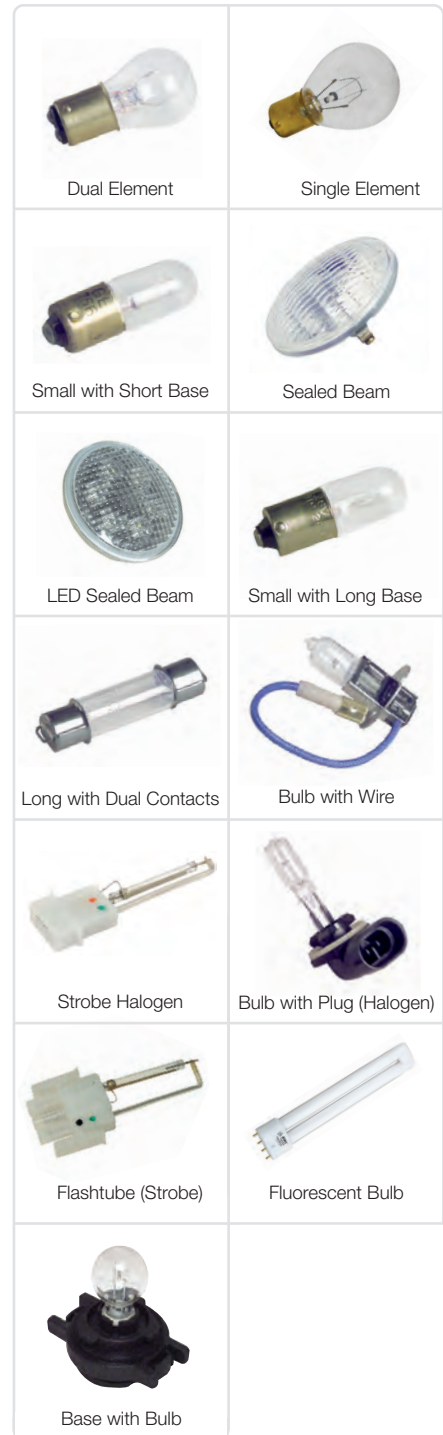

Work Lights

Part Number	Description	Voltage	Series	Replacement Bulb	Lens
107712	Front Work	12	FC/FP	112481 (12.8 volt)	Plastic
118129*	Front Work		FC/FP, RC 3000	110581 (12 volt) 118321 (38 volt) 118322 (50 volt)	Plastic
125674	Front Work	12	FC/FP	125672 (12.8 volt)	Plastic
128653	Front/Rear Work	12	FC 4000, PE 4000	125672 (12.8 volt)	Plastic
145981	Front Work	12	C5	125672 (12.8 volt)	Plastic

◀ **125674 Accessories**



Note: 1-year warranty. *Bulb not included.



LED Work Lights

Part Number	Description	Voltage	Lens	Lumens
340023-001	Bottom/Horizontal Mount	12-48	Plastic	700
340023-002	Side/Vertical Mount	12-48	Plastic	700

Note: 2-year warranty. **Replacement Part:** Wire assembly for all LED work lights is 340053.
Additional Note: FC 4000 Series trucks require Mounting Bracket P.N. 145887.

⚠ **WARNING:** Cancer and reproductive harm - www.P65Warnings.ca.gov



LED Work Light

Part Number	Description	Voltage	Lens
152949-001	Bottom/Vertical Mount - No harness, has deutsch connector. Flood lens. 2-year warranty.	12-48	Plastic

⚠ **WARNING:** Cancer and reproductive harm - www.P65Warnings.ca.gov



LED Work Light with Turn Signal

Part Number	Description	Voltage	Lens
152949-002	Bottom/Vertical Mount - White LEDs for visibility & amber for turn signal functionality. Flood lens. 2-year warranty.	12-48	Plastic

⚠ **WARNING:** Cancer and reproductive harm - www.P65Warnings.ca.gov



LED Work Light

Part Number	Description	Voltage	Lens
161763-001	Bottom/Horizontal mount included for C5 & CG trucks	12-48	Polycarbonate
161763-002	Mounting hardware not included	12-48	Polycarbonate



Work Light

Part Number - 380030-324

- RH
- 12V
- 55 Watt
- Halogen

▼ OEM Reference

CT	A0000-29523	HY	8541835	YT	580082533
HY	2064837	MB	A0000-29523	YT	580083835
HY	2098084	YT	580044915	YT	580083836
HY	8523117	YT	580053962		



Work Light

Part Number - 370751

- LH
- 12V
- 55 Watt
- Halogen

▼ OEM Reference

CT	A0000-29524	MB	A0000-29524	YT	580082534
HY	2064838	YT	580044916	YT	580083837
HY	2098085	YT	580053963		



LED Head Lamp - 12-80V

Part Number - 380030-184

- 18W LED power
- Lumens 1300
- Die-cast aluminum housing
- Waterproof rate IP67

▼ OEM Reference
HM 805



Note: 1-year warranty.



P.N. 380030-184 and 380030-185 use L-Bracket P.N. 380030-251



Note: 1-year warranty.

LED Head Lamp - 12-80V

Part Number - 380030-185

- 27W LED power
- Lumens 1755
- Die-cast aluminum housing
- 4.33" H x 4.33" W x 1.77" D
- Waterproof rate IP67

▼ OEM Reference
HM 818

Note: 1-year warranty.

Head Lamp - 12V

Part Number - 380030-130

▼ OEM Reference

AC 3EB-55-F1851	KO 8772544
AC 8766308	KO 3EB-55-A5560
AC 8772544	LP 350-4579
AC 3EB-55-A5560	KO 8766308
KO 3EB-55-F1851	KO 8772544
KO 8766308	



Note: 1-year warranty.

Head Lamp - 12V

Part Number - 380030-125

- Uses H-3 halogen bulb

Replacement bulb: P.N. 380030-160

▼ OEM Reference

CL 26010-FE300	TC 216G2-40602
CT 05101-05400	
NI 26010-FE300	



Note: 1-year warranty.

Head Lamp - 12V

Part Number - 380030-281

▼ OEM Reference

TY 56510-40580-71



Head Lamp - 12V

Part Number - 380102-212

▼ OEM Reference

TY 56510-U2230-71



Note: 1-year warranty.

Front Lamp - 12V - 2 pin

Part Number - 380030-005

▼ OEM Reference

AC 4949757	HAM 37B-1EH-2010A
HAM 4949757	HAM 37B-1EH-2010L
HAM 37B-1EA-2010	KM 4949757
HAM 37B-1EH-2010	KO 37B-1EH-2010



Note: 1-year warranty.

Lamp Assembly - 36V

Part Number - 370499

▼ OEM Reference

CL 448422	MB a0000-30163
CT a0000-30163	TY 56510-12240-71



Head Lamp - 36V

Part Number - 380030-161

▼ OEM Reference

HY 1340842	YT 518796691
HY 2304780	YT 520064601
TY 56510-13300-71	



Note: 1-year warranty.

Spot Lights

Part Number	Description	Voltage	Series	Replacement Bulb	Lens	Mounting Hardware Included
104296-001	Front/Rear	48	TSP	105619	Glass	x
104296-002	Front/Rear	36	RC, RC 3000, SC, SC 4000, Reach, TSev100, TSP	102195	Glass	x
104296S103	Front/Rear	24	Reach, SP	087195-001	Glass	x
104296-004	Spot Light	36	RC, RC3, SC, SC4, Reach, TSev100, TSP	102195	Glass	
104296-005	Spot Light	24	Reach, SP	087195-001	Glass	



104296-XXX

Note: 1-year warranty.

▲WARNING: Cancer and reproductive harm - www.P65Warnings.ca.gov

LED Spot Lights

Part Number	Description	Voltage	Series	Replacement Bulb	Lens	Mounting Hardware Included
146958	LED Spot light	12-48 12-24		146957 ▲ 346957	Plastic	
145982-001 ▲	LED Spot light	12-48 12-24		146957 ▲ 346957	Plastic	x



145982-001 (LED)

- Polycarbonate lens, can be used in food applications
- Last for life of the truck
- Lower cost of ownership than sealed beams
- Energy savings

- Bright light, more visibility
- One light, multiple voltages
- Complies with: Buy America Standards, IEC IP69K, SAE J1455, UL Recognized

LED Spot Light Replacement Bulbs:
P.N. 146957 (2-year warranty) ▲
P.N. 346957 (2-year warranty)

▲WARNING: Cancer and reproductive harm - www.P65Warnings.ca.gov

Work/Spot Lights



Halogen Spot Lights

Part Number	Description	Voltage	Series	Replacement Bulb	Lens	Mounting Hardware Included
161764-001	Halogen Spot Light	24	SP	162095-001	Glass	x
161764-002	Halogen Spot Light	36	SP	162095-002	Glass	x
161764-003	Halogen Spot Light	48		162095-003	Glass	x
161764-004	Halogen Spot Light	24		162095-001	Glass	--
161764-005	Halogen Spot Light	36	RC5500/RC5700	162095-002	Glass	--

Dome Lights



Part Number	Voltage	Series	Replacement Bulb
109810S	12	SP 3000, FC, TS, SP	110581

⚠️ **WARNING:** Cancer and reproductive harm - www.P65Warnings.ca.gov



Part Number	V/C.P.	Series	Replacement Bulb
109811	12/15	SP 3000	110578
116319	12/21	RR 3000	116364

V/C.P. = Voltage/Candle Power

Note: 1-year warranty.

⚠️ **WARNING:** Cancer - www.P65Warnings.ca.gov

Tail Lights



380030-039

Part Number	Series	Voltage	Warranty
Bulb Light			
380030-039	KM 8761802 KO 37B-1EB-3010	12	1-year
380030-076	KO 3EB-55-A6660	12	1-year
LED Light			
158270-001	⚠️	12	2-year
158270-002	⚠️	24-36	2-year
158270-003	⚠️	48	2-year
380030-077	KO 3EB-55-A7720	12	1-year

*LED not replaceable.



380030-076



158270-xxx



380030-077

158270-XXX Wiring Instructions

Wire Color Function

Wire Color	Function
White	Backup
White/Red	Tail
Red	Brake
Yellow	Turn
Black	Ground

⚠️ **WARNING:** Cancer and reproductive harm - www.P65Warnings.ca.gov

◀ Bulb Light Accessories

Replacement Lens

Part Number	Color	Used On
380030-043	One Piece	380030-039

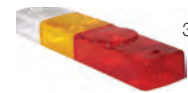

380030-043

Rear Lamp - 36V

Part No. - 380030-131

▼ OEM Reference
NI 26550-GA30A



Note: 1-year warranty.

Rear Lamp - 12V

Part No. - 380030-193

▼ OEM Reference
NI 26550-FK100



Note: 1-year warranty.

Rear Lamp - 12V (LED)

Part No. - 380030-198

▼ OEM Reference
HY 2056824
YT 580037207

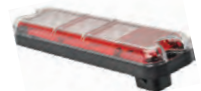

Note: 1-year warranty.

LED Strobe Lights



Flat Mount Base

Part Number	Color	Assembly Height (in)	Mounting Hole to Mounting Hole (in)	Voltage
159792-004	Amber	4.9	2.80	12-80
159792-005	Red	4.9	2.80	12-80
159792-006	Blue	4.9	2.80	12-80
340144	Green	4.9	2.80	12-80

Note: 2-year warranty.

⚠️WARNING: Cancer and reproductive harm - www.P65Warnings.ca.gov



Conduit Mount Base

Part Number	Color	Assembly Height (in)	Diameter (in)	Voltage
159792-001	Amber	5.8	2.8	12-80
159792-002	Red	5.8	2.8	12-80
159792-003	Blue	5.8	2.8	12-80

Note: 2-year warranty.

⚠️WARNING: Cancer and reproductive harm - www.P65Warnings.ca.gov



Strobe Light

Part Number	Color	Assembly Height (in)	Diameter (in)	Voltage	Series
161421-001	Amber	5.8	2.8	12-80	TSP 6000/7000 Series
161421-002	Red	5.8	2.8	12-80	TSP 6000/7000 Series
161421-003	Blue	5.8	2.8	12-80	TSP 6000/7000 Series

Note: 1-year warranty.



Flat Mount Base

Part Number	Color	Assembly Height (in)	Mounting Hole to Mounting Hole (in)	Voltage
127651-001	Amber	5.25	3.40	12-80
127651-002	Red	5.25	3.40	12-80
127651-003	Blue	5.25	3.40	12-80

Note: 1-year warranty.

Kits (Flat Mount Base Only)

Part Number	Color	Voltage	Series
127509-001	Amber	12-80	SC 4000 Series, FC 4000 Series
127509-002	Red	12-80	SC 4000 Series, FC 4000 Series
127509-003	Blue	12-80	SC 4000 Series, FC 4000 Series

Note: Kits include weldment cover and lens blackout.

◀ 159792-XXX Accessories

Accessory Guard

Part Number

118898



Blackout Lens

Part Number

161171

Replacement Lens

Part Number Color

161170-001 Amber

161170-002 Blue

161170-003 Red



138445-XXX Accessories

Replacement Lens

Part Number Color

340024-001 Amber

340024-002 Red

340024-003 Blue



⚠️WARNING: Cancer and reproductive harm - www.P65Warnings.ca.gov

◀ 161421-001 Accessories

Replacement Lens

Part Number Color

137195-001 Red

137195-002 Amber

137195-003 Blue

137195-004 Green

Replacement Bulb

Part Number

110581

⚠️WARNING: Cancer and reproductive harm - www.P65Warnings.ca.gov

◀ 127651-XXX / 112951-XXX Accessories

Replacement Lens

Part Number Color

113611 Amber

113612 Blue

113613 Red



Replacement Bulb

Part Number

340009



Accessory Guard

Part Number

118898



Blackout Lens

Part Number

113620

Strobe Lights (continued)



Strobe Lamp

Part Number	Color	Height (in)	Width (in)	Diamter (in.)	Voltage
380030-108	Amber	2.75	2.25	5.5	12-110

Note: 1-year warranty.

Replacement Flash Tube: P.N. 380101-907

▼ OEM Reference
 CL 2366970
 HM 72268A
 HY 800049142
 TY 00591-08516-81



Lamp Assembly

Part Number	Color	Height (in)	Width (in)	Diamter (in.)	Voltage
380030-237	Amber	1.25	1.75	1.75	12

▼ OEM Reference
 HY 2029548
 NI 26130-FE300
 YT 924737400

Flashing Lights - Kits

Part Number	Voltage	Series
162496-002	24	SP36, SP48
162496-001	24	SP36, SP42, SP48, TSev100

Note: 1-year warranty.



162496-002



162496-001

Spot Lights

Blue or Red LED Spot Lights

Part Number Color

160173	Blue
160173-002	Red

- 12-48V; plastic
- 65 Lumens (160173)
- 111 Lumens (160173-002)
- Polycarbonate lens, can be used in food applications
- Spot beam pattern
- Universal mount
- Does not include wiring; connector needed is 320060 & (2) contacts part number 320061



160173



160173-002



Note: 3-year warranty

⚠ **WARNING:** Cancer and reproductive harm - www.P65Warnings.ca.gov

Blue or Red LED Work Zone Lights

Part Number Color

340106	Blue
161386	Red



- 12-64V
- Mount to sides of forklift overhead guard; requires two lights (one per side)
- Light Source: 3W LED
- Lumens: 1200 LM; Output: 18W
- Aluminum housing; plastic lens; hardware included
- Mating Connector P.N. 062701-001; Mating Terminal P.N. 062704-004
- IP67, CE

Note: 2-year warranty



Arrow, LED Blue or Red Spot Light

Part Number Color

340093-002	Blue
340093-003	Red

- 12-60V, 0.6 amps
- Blue arrow light
- Polycarbonate lens, can be used in food applications
- Aluminum housing
- Universal mount



Note: 3-year warranty

⚠ **WARNING:** Cancer and reproductive harm - www.P65Warnings.ca.gov

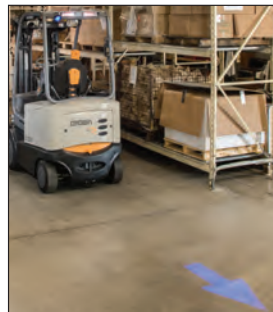

Blue LED Spot Light

Part Number Color

340093	Blue
--------	------

- 12-80V
- 55 Lumens
- Polycarbonate lens, can be used in food applications
- Spot beam pattern
- Wire connector
- Universal mount
- UL Certified



Note: 3-year warranty



Blue/Red Light Kits

Truck Models	Power Unit 1st				Forks 1st			
	Premium Blue LED Spot Light (160173)	Blue LED Spot Light (340093)	Arrow Blue LED Spot Light (340093-002)	Premium Red LED Spot Light (160173-002)	Premium Blue LED Spot Light (160173)	Blue LED Spot Light (340093)	Arrow Blue LED Spot Light (340093-002)	Premium Red LED Spot Light (160173-002)
RC5500	340200	340200-001	340200-003	340200-002	-	-	-	-
RR 5200/ 5200AC & RR5700	340202	340202-001	340202-003	340202-002	340202	340202-001	340202-003	340202-002
C5 Cushion	340201	340201-001	340201-003	340201-002	340203	340203-001	340203-003	340203-002
FC4000/4500 & FC5200	340203	340203-001	340203-003	340203-002	340203	340203-001	340203-003	340203-002
SC4000/4500 & SC5200	340203	340203-001	340203-003	340203-002	340203	340203-001	340203-003	340203-002
SP3200/3400/ 3470 & SP3500	340205	340205-001	340205-003	340205-002	-	-	-	-
TSP6000/6500 & TSP7000	340206	340206-001	340206-003	340206-002	-	-	-	-
RM/RMD 6000	340210	340210-001	340210-003	340210-002	340211	340211-001	340211-003	340211-002
PE4000 & PE4500	340207	340207-001	340207-003	340207-002	340207	340207-001	340207-003	340207-002
Both Directions	340208	340208-001	340208-003	340208-002	-	-	-	-
Additional Light	340209	340209-001	-	340209-002	-	-	-	-

Complete model-specific kits include spot light and all necessary mounting hardware for a professional fit.

⚠ **WARNING:** Cancer and reproductive harm - www.P65Warnings.ca.gov



Blue or Red LED Line Light

Part Number Color

162737-002	Blue
162737-001	Red

Note: The lens of the light is clear, the red/blue light is emitted from LEDs.

Note: 5-year warranty

- 12-48v; Output: 14W
- Polycarbonate lens, can be used in food applications.
- Cast aluminum housing and mounting hardware included.
- IP69K, CE

Red LED Arc Light

Part Number Description

171615-001	Light without Bracket
171615-011	Light with Bracket



- 12-72V
- 100 lumens
- Polycarbonate lens, can be used in food applications
- Aluminum housing
- Universal mount
- IP67, IP69K



Note: 1-year warranty

Horns



Electronic Horn with Straight Bracket

Part Number	Voltage	Life Cycles	Decibels (minimum)
332198	24, 36, 48	500,000	105 dB
332199	12, 24	1,000,000	105 dB



Part Number - 360038-276

Electronic Horn with Straight Bracket (24, 36, 48 Volt)

Decibels (minimum): 112 dB
3 Terminals



Electronic Horn with "L" Bracket

2 Terminals

Part Number	Voltage	Life Cycles	Decibels (minimum)
159162	24, 36, 48	500,000	105 dB
147631-003	24, 36, 48	500,000	105 dB

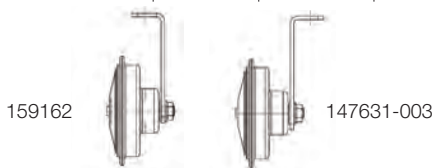

Multi-Voltage Electronic Horn with "L" Bracket

3 Terminals

Part Number	Voltage	Decibels (minimum)	Stnd on (Models)
162957-001	12, 24, 36, 48, 72	105 dB	Reach, RR, SC, FC & TSP



Mechanical Horns

Part Number	Voltage	Life Cycles	Decibels (minimum)
078708-011	12	60,000	108 dB
078708-002	24	60,000	108 dB



Part Number - 370667

Horn Mini (12 Volt)

- ▼ OEM Reference
- AC 3EB-55-41271
 - HY 2021957
 - KO 3EB-55-41271
 - KO 8778367



Part Number - 143503

Electronic Horn with "L" Bracket (12 Volt)

Decibels (minimum): 105 dB

Note: Kit includes: horn, L-bracket, harness and kit instructions.



Part Number - 370748

Electronic Horn (12 Volt)

105-118 dB

▼ OEM Reference

- HY 152764
- HY 1618978
- HY 4005218
- YT 580036342
- YT 550005823
- YT 580068957



Part Number - 398000-154

Horn Assembly (12 Volt)

- ▼ OEM Reference
- TY 58120-26640-71



Part Number - 380030-200

Horn (12 Volt)

- ▼ OEM Reference
- NI 25620-GH10A

Warning Devices

Horns



Part Number - 380700-024

Horn (24 Volt)

Decibels (minimum): 112 dB
3 Terminals

▼ OEM Reference

BT	590-460-101	PM	590-629
BT	590-629	PM	590-640-001
BT	590-640-001	PM	590-640-101
BT	590-640-101	PM	590-642-001
BT	590-642-001	PM	590-643-001
BT	590-643-001	PM	590-643-001-ORG
BT	590-643-001-ORG	RA	590-460-101
CT	1008767	RA	590-629
CT	NA015879	RA	590-640-001
CT	NA019240	RA	590-640-101
CT	NA020529	RA	590-642-001
MB	1008767	RA	590-643-001
MB	NA015879	RA	590-643-001-ORG
MB	NA019240	TY	00590-42448-71
MB	NA020529	TY	00590-43983-71
PM	590-460-101		



Part Number - 370347

Horn (24, 48 Volt) Electronic H-Tone

Decibels (minimum): 112 dB
3 Terminals

▼ OEM Reference
RA 590-643-104



Suppressor

Part Number **Description**

077732	For use with mechanical horns, 078708.
129579	Suppressor only needed in certain applications with horn styles 159162 and 332198.
159161	Suppressor kit required for RC5500s built prior to December 2015

Back-Up Alarms



Part Number	Voltage	Decibel Level	Type
149538	12-80	87	Standard
115565	12-48	97	Standard
126035	12-48	77-87-97	Standard
129615	12-48	77-97	Smart
139068-001	12-24	82-102	Smart

▲ **WARNING:** Cancer and reproductive harm - www.P65Warnings.ca.gov

◀ **Accessories:** Filter Block (P.N. 112533) for use with back-up alarms.



Filter Block Wiring Diagram

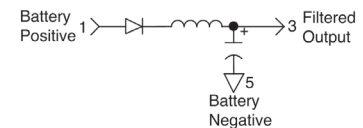

Harnesses

Part Number	Description
126036	Cord w/spade terminals
154030	Cord with Deutsch pins

To be used with the 126035 alarm ONLY

126036

154030

▲ **WARNING:** Cancer and reproductive harm - www.P65Warnings.ca.gov



Part Number - 360038-279

Back-Up Alarm\Horn 12-24V, 102 dB (minimum)

▼ OEM Reference

CL	914772	HY	0377875
CL	6499931	MB	215411
CT	215411	MB	914584
CT	914584	MB	A000031698
CT	A000031698	TY	00591-08099-81
HY	1350735	YT	220101215
HY	0346495	YT	505969500



Part Number - 361038-279

Back-Up Alarm 12-24V, 97dB

▼ OEM Reference

HY	0206749	YT	524143269
HY	2042675	YT	580045134
HY	2064930		



Part Number - 370750

Back-Up Alarm 12-24V, 82-102 dB (minimum)

▼ OEM Reference

HY	2064929	YT	580045132
HY	8522216		



Part Number - 370459

Back-Up Alarm\Horn - Electronic 107 dB, 24-48V, M/F Spade Connector

▼ OEM Reference

HY	1483422	NI	25620-FS000
BR	25620-FS000	NI	25620-FS001
BR	25620-FS001		

Deutsch Connectors

Deutsch DT Connector Kits



Part No.	No. of Circuits	Dust Cap
130197-002	2	366002-002
130197-003	3	
130197-004	4	
130197-006	6	066002-004
130197-008	8	366002-008
130197-012	12	

Note: Kits include receptacle, plug, contacts, seals, inserts, and instructions on how to use extraction tool and crimping tool. Used with 20-14 gauge wire.

▲ Replacement Contacts

Part Number	Description	Quantity
130197-015	Pin, Nickel	25
130197-016	Socket, Nickel	25
130197-017	Pin, Gold	25
130197-018	Socket, Gold	25

Note: Used only on 130197-XXX.

⚠ **WARNING:** Cancer and reproductive harm - www.P65Warnings.ca.gov

Deutsch DTM Connector Kits



Part Number	Number of Circuits
131237-002	2
131237-003	3
131237-004	4
131237-006	6
131237-008	8
131237-012	12

Note: Kits include receptacle, plug, contacts, seals, inserts, and instructions on how to use extraction tool and crimping tool. Used with 22-16 gauge wire.

▲ Replacement Contacts

Part Number	Description	Quantity
131237-015	Pin, Nickel	25
131237-016	Socket, Nickel	25
131237-017	Pin, Gold	25
131237-018	Socket, Gold	25

Note: Used only on 131237-XXX.

⚠ **WARNING:** Cancer and reproductive harm - www.P65Warnings.ca.gov



Extraction Tool

Part Number - 062706

Used to remove Deutsch pin and socket contacts from DT and DTM connectors.



Crimping Tool

Part Number - 062737-002

For stripping insulation and crimping new terminals on light gauge electrical wire for insertion into Deutsch DT and DTM connectors.

GE Plug Kits

Plug Kit (A)

P.N. 108934

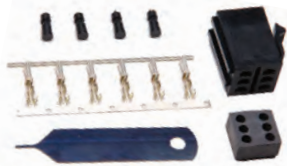

Plug Kit (B)

P.N. 108935



Plug Kit (Y)

P.N. 112528

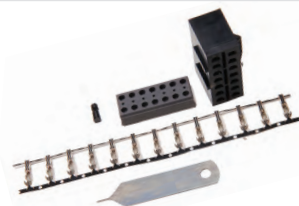

Plug Kit (Z)

P.N. 108936



▲ Plug Kit Reference - Control Card

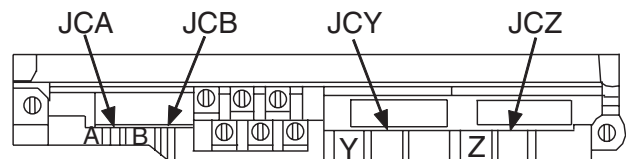

Grounding Straps

Part Number	Length (in.)
102126-004	5.75
102126-003	8.50
102126-002	10.50
102126-005	12.50
102126-001	18.00

Resistivity 100 OHM-CM



Part Number - 370286

Cable Assembly Drag

Overall length 11", cable length 10",
3/8" diameter, terminal hole dia. 1/4"

▼ OEM Reference

RA 154-009-116	RA DS227245
RA 154-009-116/001	TY 00590-47108-71



Switches - Rocker and Toggle



Part Number - 117268

Turtle / rabbit symbols
Single pole / single throw

▼ OEM

SW 2139	TY 00591-45237-81	YT 220015942
LP 393-2604		



Part Number - 062595-005

On-none-on
SPDT

▼ OEM

HY 800130867	TY 800130867
--------------	--------------

▲ WARNING: Cancer - www.P65Warnings.ca.gov



Part Number - 062595-001

On-off-on
SPDT

▼ OEM

HY 800018665	SW 1792	YT 220041952
LP 393-9904	TY 00591-73979-81	YT 800018665

▲ WARNING: Cancer - www.P65Warnings.ca.gov



Part Number - 062595-007

On (momentary)-none-on
SPST

▲ WARNING: Cancer - www.P65Warnings.ca.gov



Part Number - 062595-002

On-none-off
SPST

▼ OEM

SW 1793	LP 393-9905	YT 220042503
HY 800018666	TY 00591-73980-81	YT 800018666

▲ WARNING: Cancer - www.P65Warnings.ca.gov



Part Number - 077633

Single pole / single throw
6A @ 125vdc
3A @ 250vdc

▼ OEM

CL 7004240	TO 215054	YT 220014497
HY 800076231	TY 00591-41984-81	YT 800076231
SW 430	TY 00591-60665-81	



Part Number - 351096-347

Toggle Switch

▼ OEM

BK 709805	LI 709805	TY 00591-32323-81
CL 1405848	MB 0973020	TY 00591-57413-81
CL 314328	RA 590-097	TY 00591-70452-81
CT 0973020	RA 590-097-001	TY 00591-70549-81
DX 1405848	RA 590-097-01	YT 220002261
HY 3018438	RA 590-970-1	YT 220010358
HY 3026530	RA DS227683	YT 220016771
HY 3039786	SJ 102583	



Part Number - 062595-003

On (momentary)-off-on (momentary)
SPDT

▼ OEM

SW 1794	LP 393-9906	YT 220042501
HY 800018687	TY 00591-73985-81	YT 800018687

▲ WARNING: Cancer - www.P65Warnings.ca.gov



Part Number - 062595-004

On (momentary)-none-on
DPDT

▼ OEM

SW 1795	TY 00591-73981-81	SW 1832
HY 800018667	YT 800018667	LP 393-7922
LP 393-9907		

▲ WARNING: Cancer - www.P65Warnings.ca.gov



Part Number - 360038-275

Master on-off switch

▼ OEM

AC 305493-000	PM 305493-000	RA 939-352-217
BT 305493-000	RA 305493-000	TY 00590-40983-71
KO 305493-000		



Part Number - 109759

600vac
12A

▼OEM

SW 1377	TY 00591-32296-81	YT 220015021
CL 7004135	TY 00591-60557-81	YT 800058911
HY 800058911	TY 00591-70676-81	



Part Number - 109758

600vac
12A

▼OEM

SW 1348	TY 00591-32290-81	TY 00591-60556-81
HY 3013965	TY 00591-52550-81	YT 220003692
TY 00591-05093-81		



Part Number - 089362-00S

Operating Force 6.5 oz min.
15A @ 125 and 250vac
0.6A @ 125vdc
0.3A @ 250vdc

▼OEM

CL 444113	LP 393-8125	TY 00591-57447-81
HY 3012366	TO 215930	YT 220003207
HY 800076716	TY 00591-05049-81	YT 220030452
SW 1283	TY 00591-32276-81	YT 800076716



Part Number - 082605

15A @ 30vdc

▼OEM

BA LF021874	SW 2154	YT 220016301
HY 800076416	LP 393-2533	YT 800076416



Part Number - 062714

15A
SPDT
Operating Force 90 grams max.

▼OEM

SW 1831	LP 393-7921
---------	-------------



Part Number - 073375

15A @ 125vac & 250vac
SPDT
Operating Force 20 oz max

▼OEM

CL 443898	SW 1227	TY 00591-57409-81
CL 946483	LP 393-2500	YT 220003926
CL 7004078	TO 216162	YT 800076075
HY 3015165	TY 00591-04651-81	
HY 800076075	TY 00591-32247-81	



Part Number - 113352

15A @ 1/2 HP 125/250vac
SPDT

▼OEM

SW 1897	LP 393-2798
---------	-------------



Part Number - 082813

Operating force 45 oz. max.
Double Pole, Double Throw
Normally Closed

▼OEM

CL 7004134	TY 00591-41846-81	YT 220014503
HY 800058813	TY 00591-60694-81	YT 800058813
SW 1376	TY 00591-70619-81	



Part Number - 088294

Operating Force 7.8 max.

▼OEM

CL 7004239	SW 429	YT 800076690
HY 800076690	TY 00591-32345-81	



Part Number - 101589

Operating Force 15 oz max
15A @ 125vac and 250vac

▼OEM

CL 7004122	TO 216135	TY 00591-60538-81
HY 800075101	TY 00591-04181-81	YT 220016504
SW 1359	TY 00591-32291-81	YT 800075101

Part Number - 147014



(spade connectors)

Part Number - 360038-287



(screw-on connectors)

General Purpose
Single Throw
Single Pole
Normally Open
2A 48VDC

▼OEM

CL 7004060	HY 800019130	TY 00591-60635-81
CT A000031300	MB A000031300	YT 220014587
CT 216161	MB 216161	YT 800019130
GE 3ASM5A3B3	TO 216161	
HY 3012350	TY 00591-32227-81	



Part Number - 077656

15A, 250vac
SPDT
Operating Force 14-20 oz.

▼OEM

BA 130091	SW 32	YT 6202871
BA 985383	SW 33	YT 220023939
BA 985838	SW 342	YT 220037742
BA 986600	SW 344	YT 220043325
BA 997030	LP 393-2160	YT 220051993
BA 177MJH1	LP 393-2172	YT 500205100
BA BZ2RQ13A2	RA 1-150-324	YT 600287100
BA BZ2RQ1A2	RA 590-023	YT 620287100
BA PAL32	RA 590-058	YT 620287101
BA PAL-32A	RA DS226498	YT 62028710A
CL 991179	TO 0972328	
HY 1371673	TO 1009550	
HY 2307677	TY 00591-32333-81	
HY 3007411	TY 00591-51917-81	
HY 3008403	TY 4516581100-71	



Part Number - 072007

25A - 125-250vac
1 HP @ 125vac
2 HP @ 250vac
Operating Force 30 oz max.

▼OEM

CL 7004058	TY 00591-41779-81	YT 220021468
SW 1197	TY 00591-60632-81	



Part Number - 078879

25A 125 - 250vac
1 HP @ 125vac
2 HP @ 250vac
Operating Force 30 oz max.

▼OEM

CL 7004059	TO 215965	YT 220002205
HY 3017812	TY 00591-32226-81	
SW 1198	TY 00591-60668-81	



Part Number - 079133

15A, 125-250vac
¼ HP @ 125vac
1½ HP @ 250vac
Operating Force 15 oz max.

▼OEM

CL 7004092	LP 393-8216	TY 00591-60672-81
HY 800076274	TO 216134	YT 220015887
SW 1275	TY 00591-32271-81	YT 800076274

▲WARNING: Cancer and reproductive harm - www.P65Warnings.ca.gov



Part Number - 077133-001

Blue
10A @ 28vdc

▼OEM

CL 7004054	TO 216159	YT 220013133
HY 3013964	TY 00591-04742-81	YT 800076207
HY 800076207	TY 00591-32220-81	
SW 1191	TY 00591-52537-81	

▲WARNING: Cancer - www.P65Warnings.ca.gov



Part Number - 370575

Switch

▼OEM

BK 72-2085/53008	LI 72-2085/53008	TY 00591-32244-81
CL 7004076	RA 1130363-KIT	TY 00591-63083-81
DS P181-0013	RA 1-150-028	TY 00591-70165-81
HY 3005701	RA 821-003-202	YT 220001752



Part Number - 077133-002

Black
SPDT
10A @ 28vdc

▼OEM

CL 7004055	TO 216155	TY 00591-60663-81
HY 800076208	TY 00591-04743-81	YT 220003691
SW 1192	TY 00591-32221-81	

▲WARNING: Cancer - www.P65Warnings.ca.gov



Part Number - 062683

Operating force 75 grams max
Release force 10 grams min
SPDT with gold contacts

▼OEM

HY 800018685	LP 393-2325	YT 800018685
SW 1643	TY 00591-73984-81	



Part Number - 086221

▼OEM

CL 7004131	LP 393-7910	TY 00591-70648-81
HY 800058861	TY 00591-41845-81	YT 220014951
SW 1373	TY 00591-60714-81	YT 800058861



Part Number - 075198

Single pole - double throw
Operating force 8 oz
Release force 4 oz

▼OEM

AC 4932316	LP 393-4230	YT 015804500
AC 74932316	PM 201199	YT 052332800
BA 992567	PM QU-161A8598G1	YT 220023578
BR A27350-6	RA 1150-034	YT 220024965
CL 996101	RA 1150-322	YT 220051040
HY 1194848	RA 921-000/224	YT 500742800
HY 3008482	RA DS226131	YT 721260301
HY 3012351	TO 0972065	YT 721260303
HY 800076158	TO 1009548	YT 800076158
HY 800076269	TY 00591-04789-81	YT 800076269
HY A3720	TY 00591-32318-81	YT 0136151CB
SW 151CB	TY 00591-51929-81	YT 136151-CB
KO 7870-30-7120	TY 00591-51930-81	YT 549-GS-92-A
KO 7870-30-7210	YT 015804300	YT 549-GS-92-B
KO 78703-07210	YT 015804400	YT 6136151CB
LP 393-4219		



Part Number - 062766

10 A @ 115/230 1/2 HP
2 circuit, 1 Normally Open, 1 Normally Closed Double Break

▼OEM

AC 4932316	PM 201199	YT 015804400
AC 74932316	PM QU-161A8598G1	YT 015804500
BA 992567	RA 1150-034	YT 052332800
BR 27350-006	RA 1-150-322	YT 220023578
BR A27350-6	RA 921-000-224	YT 220024965
BR A-27350-6	RA DS226131	YT 220051040
CL 996101	TO 0972065	YT 500742800
HY 1194848	TO 972065	YT 721260301
HY 3008482	TO 1009548	YT 721260303
HY 3012351	TY 00591-04789-81	YT 800076158
HY 800076158	TY 00591-32318-81	YT 800076269
HY 800076269	TY 00591-51929-81	YT 0136151CB
HY A-3720	TY 00591-51930-81	YT 549-GS-92-A
SW 151CB	YT 158044	YT 549-GS-92-B
KO 7870-30-7120	YT 158045	YT 6136151CB
KO 78703-07210	YT 523328	
LP 393-4219	YT 5007428	
LP 393-4230	YT 015804300	



Part Number - 370323

Micro Switch

▼OEM

AC 306097-000	KO 8734741	RA 306097-000
BT 306097-000	PM 306097-000	



Part Number - 351096-278

Directional Switch

▼OEM

RA 1-150-383



Part Number - 087373

Operating force 6.5 oz max
Release force 1.5 oz min. 10A @ 30vdc

▼OEM

AC 4778736	CL 7004253	TO 9I2463
AC 4795031	CL 906619	TO MCF00311
AC 4798071	DW 908450	TO MCF00313
AC 74778736	HY 2304182	TY 00591-32194-81
AC 74795031	HY 2311178	TY 00591-32359-81
AC 74798071	HY 3016151	TY 00591-51916-81
BA 106944	HY 519515302	TY 00591-51928-81
BA 106994	SW 1039	TY 00591-60541-81
BA 709677	SW 151FA	YT 5148261
BA 985402	SW 1859	YT 5152921
BA 992717	SW 983	YT 220002082
BA 177MBH1	KO 34B-55-23610	YT 220015035
BA BXRW22A2	KO 34B-55-23610	YT 220015420
BA BZ2RM22A2	KO 34B-57-23610	YT 220023943
BA BZ2RW22A2	KO 3BA-57-23610	YT 220051964
BA CB6	LP 393-2142	YT 514826100
BA CB61	LP 393-4172	YT 515292100
BA CB6-1	PM 49965-00	YT 01361510F
BA CB6DASH1	PM A49965	YT 01361510N
BK 3736759	TO 0015949	YT 0136151FA
BR 28841-330	TO 0060302	YT 519515302
BR 29000465-000	TO 0300905	YT 61361510F
BR T29-465	TO 0319033	YT 61361510N
BR T-29-465	TO 0336130	YT 6136151FA
CL 1310067	TO 0659968	YT 61361510N
CL 2795597	TO 0908450	YT 6136151FA
CL 7004041	TO 0972189	



Part Number - 370249

Switch

▼OEM

CL 1304793	CL 3788232	HY 3049726
CL 2394430	HY 2303007	HY 3057595
CL 2803519	HY 3020121	YT 519515301



Part Number - 123437

Operating force 8.5 oz max,
Release force 1.5 oz min

▼OEM

IN SW-1595	LP 393-2532	YT 800108047
HY 800108047	YT 220035914	



Part Number - 062715

Operating force 175 grams
Release force 19 grams

▼OEM

SW 1789	LP 393-1939	TO SE000006
SW 1830	LP 393-7920	



Part Number - 380050-044

Micro Switch

▼OEM

CL 8027922	TY 00591-51923-81	YT 5170858-04
TY 00590-00953-71	TY 00591-62171-81	YT 517085804
TY 00591-06518-81	TY 00591-74612-81	YT 580004704
TY 00591-32219-81	YT 5042272-84	YT 580004705
TY 00591-41785-81	YT 504227284	



Part Number - 073624

Operating force 6 oz max
Release force 1.5 oz min.
15A @ 30vdc



Part Number - 079267

Operating Force 6 oz max
25A @ 125/250vac
1 HP @ 125vac
2 HP @ 250vac

▼OEM

HY 800076277	TY 00591-41801-81	YT 220015460
SW 1274	TY 00591-60673-81	YT 800076277
TY 00591-04793-81		

Switches - Snap Action



Part Number - 360038-266

Switch

▼OEM

AC 308030-000	PM 308030-000	RA 939-353/033
BT 308030-000	RA 308030-000	TY 00590-43472-71
KO 308030-000	RA 939-353-033	



Part Number - 077481

Switch

Part Number - 360038-266

Switch

▼OEM

CL 778570	HY A121224	TY 00591-04755-81
HY 121224	SW 1029	TY 00591-41762-81
HY 1198464	LP 393-8115	TY 00591-57445-81
HY 3007247	LP 393-9153	



Part Number - 360038-272

Limit Switch

▼OEM

AC 20208-00	HY 800138722	RA 939-352-203
AC 8730061	HY 394077	TC 20208
AC OP03001097	KO 20208-00	TY 00590-00614-71
BT 1-150-366	KO 8730061	TY 00590-40669-71
BT 20208-00	KO OP03001097	TY 00591-03582-81
BT P-20208	PM 1-150-366	TY 00591-32249-81
CL 908622	PM 20208-00	TY 00591-63517-81
CT 1075093	PM P-20208	TY 800138722
HY 3055612	RA 1-150-366	

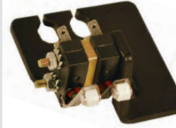

Part Number - 370326

Switch & Bracket Kit

▼OEM

AC OP03001122	KO 8736071	PM 308518-000
BT 308518-000	KO OP03001122	RA 308518-000
HY 800131447		



Part Number - 360038-274

Lift Limit Switch

▼OEM

BT 20208-01	RA 20208-01	TY 00590-43475-71
PM 20208-01	RA 939-353-267	



Part Number - 380500-644

Emergency Disconnect Switch

▼OEM

RA 1-150-313-057



Part Number - 370649

Disconnect Switch

▼OEM

YT 580019665



Part Number - 370145

Switch

▼OEM

HY 1486370
YT 580019693

Switches - Key

Continued ▶



Part Number - 380050-040

Ignition Switch

Includes: two keys

▼OEM

CL 7004147	JU 14483690	YT 504240854
CT 216444	TY 00591-06240-81	YT 580007799
HY 379902	TY 00591-32300-81	YT 580021375
HY 379902	TY 00591-51265-81	YT 580022227
HY 1492154	YT 220003423	
HY 2035830	YT 504240838	



Part Number - 380050-022

Ignition Switch

▼OEM

NI 25150-02H01
NI 71675-00549

Note: Replacement keys not available



Part Number - 370556

Switch - Key

Includes: two keys - 3 terminal

▼OEM

CT 1009551	RA 1-150-339
CT 1086859	RA DS224390
CT 1086860	TY 00590-00531-71
HY 3121840	TY 00590-00532-71
MB 1009551	TY 00591-21062-81
MB 1086859	YT 220018476
MB 1086860	



Part Number - 370501-257

Ignition Switch

▼ OEM

- BT 851-200-055
- PM 851-200-055
- RA 851-200-055



Part Number - 380051-002

Ignition Switch

▼ OEM

- NI 25150-GG10B
- NI 25150-GJ90B

Note: Replacement keys not available



Part Number - 370054

Includes: two keys

Note: Uses replacement keys-2 370054-001

▼ OEM

AC 4734244	HY 1197960	RA 590-004
BJ 20725	HY 1197961	RA 590-006
BK 152202	HY 2033697	RA 812-001-255
CL 1681146	HY 2303433	RA 921-000-887
CL 2345332	HY 2305167	RA DS223177
CL 2809875	HY 254007	RA DS224389
CL 301728	HY 3005833	RA DS226396
CL 352148	HY 3052440	SC 41-25093
CL 3700309	HY 3066611	TA 71120
CL 3853257	HY A-3716	TA 71-120-00
CL 611885	HY A-3716-1	TY 00590-00613-71
CL 613472	HY A-3716-2	TY 00591-01780-81
CL 624112	HY A-49164-A	TY 00591-32356-81
CL 624597	HY A-49164A	TY 00591-41881-81
CL 678376	MB 1009544	TY 00591-41950-81
CL 7004163	MB 1055276	TY 00591-51256-81
CL 896614	MB 1086860	TY 00591-51257-81
CT 972202	MB 972202	YT 16051600
CT 1009544	MB NA013888	YT 47001100
CT 1055276	MB NA013889	YT 50649900
CT 972202	MB NA013890	YT 80142300
CT NA013888	PB 304387K	YT 500863100
CT NA013889	PB 3304387K	YT 500863101
CT NA013890	RA 114-010-175	YT 500863102
HY 254007	RA 1-150-065	YT 500863104
HY 1197132	RA 1-150-368	YT 500863105
HY 1197133	RA 1-150-378	YT 500863110
HY 1197134	RA 1-150-392	YT 645082800
HY 1197135	RA 1020341/004	
HY 1197136	RA 154-005-697	



Part Number - 108066

Includes: two keys

▼ OEM

AC 3EB-55-A3621	HY 0202017	MB 376938
AC 4722682	HY 0260873	MB 971156
AC 4848481	HY 0272041	MB 972252
AC 4848483	HY 0392891	MB 972256
AC 4910557	HY 131116	MB 972293
AC 4913250	HY 1328442	MB 9X2143
AC 4966572	HY 181332	ME SM7-85
AD 56478640	HY 186305	MJ V4866/3
AF 00304	HY 202017	NI 125-0017
BR 125-0017	HY 260873	TN 47485
CL 1659819	HY 265211	TY 00591-00142-81
CL 1723186	HY 272041	TY 00591-03098-81
CL 1756213	HY 2798391	TY 00591-06155-81
CL 2339413	HY 3001108	TY 00591-32298-81
CL 2342572	HY 3001109	TY 00591-32357-81
CL 2342572R	HY 3001875	TY 00591-32361-81
CL 2342572-R	HY 3020087	TY 00591-41956-81
CL 2356172	HY 3044816	TY 00591-51251-81
CL 2394129	HY 3053416	TY 00591-51255-81
CL 3480033	HY 3057812	TY 00591-51259-81
CL 668782	HY 3122805	TY 00591-51266-81
CL 7004210	HY 3124064	TY 00591-60555-81
CT 0366463	HY 3135532	TY 220000801
CT 0971156	HY 392891	TY 220000860
CT 0972252	HY 55959	TY 220002990
CT 0972256	HY 800000360	TY 220003465
CT 0972293	HY 800013610	TY 220012746
CT 332270	HY 800083450	TY 220019875
CT 354343	JU 14491250	TY 220027238
CT 366463	KO 31-242	TY 220037812
CT 376938	KO 3EB-55-16190	WM 10A18229
CT 971156	KO 3EB-55-A3621	WM 203011631
CT 972252	KO 3EB-55-A3630	YT 220000801
CT 972256	KO 4722682	YT 220000860
CT 972293	KO 4783418	YT 220002990
CT 9X2143	KO 4832941	YT 220003465
DR 1116553	KO 4834418	YT 220012746
DR 116508	KO 4845729	YT 220019875
DR D-1460	KO 4848481	YT 220027238
DW 366463	KO 4848483	YT 220037812
ET 35035	KO 4910557	YT 277236300
ET 35041	KO 4913250	YT 330027845
ET 35388	LI KM31-242	YT 330028829
ET 35625	LI KM3EB-55-A3621	YT 330028830
ET 35705	MB 0366463	YT 330033742
ET 35746	MB 0971156	YT 330050314
ET 35750	MB 0972252	YT 330050421
HK 4966572	MB 0972256	YT 330050546
HY 0055959	MB 0972293	YT 330051166
HY 0131116	MB 332270	YT 330053819
HY 0181332	MB 354343	YT 330058266
HY 0186305	MB 366463	YT 504227254



Part Number - 146286

Includes: two keys

▼ OEM

AC 14835-22	HY 3005111	MB A221
AC 20151-00	HY 3007557	MB B2007
AC 4003998	HY 3056776	PM 20151-00
BK 130659	HY 3144134	PM P-20151
BK 992516	HY 800057763	RA 20151-00
BR 28842-300	HY 800076063	SC 31-40156
BT 14835-22	HY 800132257	SC 33-12112
BT 20151-00	HY 800133230	SC 33-12113
CL 908586	KO 14835-22	SC 33-12130
CL 919487	KO 20151-00	TC 20151
CT 0053635	KO 8730954	TC P-20151
CT 0338753	LI 130659	TY 00591-04645-81
CT 0A221	LI 992516	TY 00591-07636-81
CT 0B2007	LI A1132	TY 00591-51261-81
CT 338753	MB 0053635	TY 220001540
CT 53635	MB 0338753	TY 220020175
CT A221	MB 0A221	TY 220044134
CT B2007	MB 0B2007	TY 220001540
ET 35046	MB 338753	TY 220020175
HY 1049164	MB 53635	TY 220044134



Part Number - 370329

Key Switch

▼ OEM

- HY 2057948
- YT 580037904

Switches - Key



Part Number - 062623

Keyless Switch

Four Switch Positions

1. Accessories Only
2. Off Position
3. Accessories and Ignition
4. Ignition and Start (Spring Return)

▼OEM

HY 800085364	LP 309-2271	YT 220025682
SW 1598	TY 00591-14061-81	YT 800085364
KO 31-608		

Knurled Nut Replacement Part:
P.N. 340103



Part Number - 123455

Key Switch Assembly

Three Switch Positions

1. Off
2. "IGN" & "ACC" on
3. "IGN" & "ST" on w/spring return to position 2

▼OEM

LP 309-2279	HY 800017037	YT800017037
-------------	--------------	-------------

Knurled Nut Replacement Part:
P.N. 340102



Lift Truck Power Switch Keys

Part Number	Type	Truck Series
107151-001	Molded	Walkies, Pallet, Tuggers, PR, Wave
089216-001	Not Molded	
107151-002	Molded	Reach, Turret, Stockpickers, Counterbalance, PR
107543-001	Not Molded	



107151-001



089216-001



107151-002



107543-001



Part Number - 380030-134

Key

▼OEM

NI KEY00-GB01A



Part Number - 370581

Key for Gas Trucks

▼OEM

NI KEY00-000X7



Part Number - 370235

Key - 2 Pieces

▼OEM

TY 57591-23330-71



370087

Key - 2 Pieces

Part Number Notes

370087	Fits TVH and OEM Ignition Switch
370054-001	Works with 370054 Ignition Switch



370054-001

▼OEM

CL 7004106	HY 3131733	YT 220041746
CL 905512-R	TY 00591-16442-81	YT 500863106
HY 2309436	TY 00591-41818-81	
HY 262798	YT 220014812	



Part Number - 370328

Key - 2 Pieces

▼OEM

AC 8732356	HY 800063427	PM 302092-000
AC OP03001094	KO 302092-000	RA 302092-000
BT 302092-000	KO 8732356	YT 220031307
CL 919818	KO OP03001094	
CT A000018907	MB A000018907	



Part Number - 370303

Key Set - 2

▼OEM

YT 504240712



Part Number - 370784

Key - 2 Pieces

▼OEM

BJ 1120-500016-10



Part Number - 370501-341

Key Set - 2

▼OEM

BT 1020341-002	MB NA014667	TY 00590-00538-71
CT NA0021313	MB NA021313	TY 00590-48165-71
CT NA014667	PM 1020341-002	
CT NA021313	RA 1020341-002	

Wire and Cable

Power Cable

Gauge	Color	UL Rated	Bulk Part Number	10 ft box 305 cm	12 ft box 366 cm	50 ft reel, 1,524 cm	100 ft reel, 3,048 cm	250 ft reel, 7,620 cm	500 ft reel, 15,240 cm
6	black	UL	084568-010		384568-012				
4	black	UL	084569-105	384569-010	384569-012	384569-050	384569-105	384569-250	
4	red	UL	384575-001		384575-012	384575-050	384575-100		
2	black	UL	084570-100		344570-012	344570-050	344570-100		344570-500
2	red	UL	384576-001		384576-012	384576-050	384576-100		
1	black	UL	084571-100		344571-012	344571-050	344571-100		
1	red	UL	384571-001		384571-012	384571-050-02	384571-100-02		
1/0	black	UL	084572-021		384572-012	384572-050	384572-100		
1/0	red	UL	384574-001		384574-012	384574-050	384574-100		
2/0	black	UL	084573-013		384573-012-B		384573-100	384573-250	
2/0	red	UL			384573-012-R		384573-100-02	384573-250-0R	
2/0	red	not UL	384573-013R		384573-012R		384573-013		
2/0	orange	not UL	384573-014O		384573-012-O		384573-014		
3/0	black	UL			384579-012-B		384579-100-01		
3/0	red	UL			384579-012-R		384579-100-02		
4/0	black	UL	384577-100-01		384577-012		384577-100		
4/0	red	UL			384577-012-R		384578-100-02		
4/0	red	not UL	384578-100-01		384578-012		384578-100		

⚠ WARNING: Cancer and reproductive harm - www.P65Warnings.ca.gov



Control Cable

AWG/ Wires	Bulk Part Number	25 ft, 762 cm	50 ft reel, 1,524 cm	100 ft reel, 3,048 cm	200 ft reel, 6,096 cm	250 ft reel, 7,620 cm	500 ft reel, 15,240 cm	1000 ft reel, 30,480 cm
18-12	119203-014							
18-9	119203-011			389203-011-01			119203-016	
18-8	119203-001		389203-001-50	389203-001-01	389203-001-02	119203-002	119203-003	
18-6	389204-001-06			389204-100-06			389204-500-06	
18-5	119203-004		389203-004-50	389203-004-01		119203-005	119203-006	
18-4	087374-001	387374-025		387374-100				
18-3	119203-007			389203-007-01		119203-008	119203-009	
18-2	079495-001		389495-050	389495-100		389495-250		389495-001

⚠ WARNING: Cancer and reproductive harm - www.P65Warnings.ca.gov

Aircraft Cable, Galvanized Steel

Bulk Part Number	50 ft reel, 1,524 cm	100 ft reel, 3,048 cm	250 ft reel, 7,620 cm
083189-137	383189-050	383189-100	083189-128

Control Wire - Extra Flex

#22 AWG = 7/24/44 strands
#18 AWG = 7/59/44 strands
-50 C° to +105° C
UL1095 listed



Gauge	Color	100 ft reel, 3,048 cm	500 ft reel, 15,240 cm
22	black	126517-002	
22	brown	126517-005	
22	red	126517-008	
22	orange	126517-011	
22	yellow	126517-014	
22	green	126517-017	
22	blue	126517-020	
22	violet	126517-023	
22	gray	126517-026	
22	white	126517-029	
18	black	132187-002	132187-003
18	brown	132187-005	132187-006
18	red	132187-008	132187-009
18	orange	132187-011	132187-012
18	yellow	132187-014	132187-015
18	green	132187-017	132187-018
18	blue	132187-020	132187-021
18	violet	132187-023	132187-024
18	gray	132187-026	132187-027
18	white	132187-029	132187-030
18	red/white	132187-032	132187-033
18	green/white	132187-035	132187-036

⚠ WARNING: Cancer - www.P65Warnings.ca.gov

Freezer Control Cable

AWG/ Wires	Bulk Part Number	250 ft reel, 7,620 cm	500 ft reel, 15,240 cm
18-8	151261-001	119203-002	
18-5		351261-250	
18-3	151261-004	151261-005	151261-006

Control Wire

#18 AWG, 41 strands
0.03 min thermoplastic insulation
-40 C° to +105° C
UL1015 listed



Gauge	Color	100 ft reel, 3,048 cm
18	black	086563-002
18	brown	086564-002
18	red	086565-002
18	orange	086566-002
18	yellow	086567-002
18	green	086568-002
18	blue	086569-002
18	violet	086570-002
18	gray	086571-002
18	white	086572-002
18	red stripe/white	086573-002
18	green stripe/white	086574-002

Small DIM



Part Number	Max Voltage	Amps	Ferraz/ Gould	Littelfuse	Bussmann
340032-001	250Vac	1	GDC1	312-1	AGC1
340032-002	250Vac	2	GDC2	312-2	AGC2
340032-004	250Vac	4	GDC4	312-4	AGC4
340032-005	250Vac	5	GDC5	312-5	AGC5
340032-R06	250Vac	6	GDC-R-6	312-6	AGC-R-6
090132	250Vac	10	GDC10	312-10	AGC10
340032-015	32Vac	15	GGC15	312-15	AGC15
340032-020	32Vac	20	GGC20	312-20	AGC20
340032-030	32Vac	30	GGC30	312-30	AGC30

▲ **WARNING:** Cancer and reproductive harm - www.P65Warnings.ca.gov

Small DIM



Part Number	Max Voltage	Amps	Ferraz/ Gould	Littelfuse	Bussmann
340044-002	250Vac	2	GSC2	239002	GMD-2-R

▲ **WARNING:** Cancer and reproductive harm - www.P65Warnings.ca.gov

Small DIM - Time Delay



Part Number	Max Voltage	Amps	Ferraz/ Gould	Littelfuse	Bussmann
340039-025	250Vac	1/4	GDL1-1/4	313250	MDL-1/4
100645		1	GDL7	313001	MDL-1
340039-002	250Vac	2	GDL2	313002	MDL-2
340039-015	32Vac	15	GDL15	313015	MDL-15
100988	32Vac	20	GDL20	313020	MDL-20

▲ **WARNING:** Cancer and reproductive harm - www.P65Warnings.ca.gov

Small DIM



Part Number	Max Voltage	Amps	Ferraz/ Gould	Littelfuse	Bussmann
340049-001	250Vac	1	GGM1	235001	GMA-1-R
094744	250Vac	3	GGM3	235003	GMA-3-R

▲ **WARNING:** Cancer and reproductive harm - www.P65Warnings.ca.gov

Medium Time Delay



Part Number	Max Voltage	Amps	Ferraz/ Gould	Littelfuse	Bussmann
340045-001	250Vac	1	GSC1	235-1	GMC-1-R
340045-005	125Vac	5	GSC5	235-5	GMC-5-R

▲ **WARNING:** Cancer and reproductive harm - www.P65Warnings.ca.gov

Time Delay - Low Breaking



Part Number	Max Voltage	Amps	Ferraz/ Gould	Littelfuse	Bussmann
127038-001	250Vac or less	1/4	GDG1/4	218.250	GDC250mA
340034-001	250Vac or less	1	GDG1	218.001	GDC1

▲ **WARNING:** Cancer and reproductive harm - www.P65Warnings.ca.gov

Semiconductor



Part Number	Max Voltage	Amps	Ferraz/ Gould	Littelfuse	Bussmann
340033-012	250Vac/125Vdc	12	250VFA6X32	322-12	GBB12R

▲ **WARNING:** Cancer and reproductive harm - www.P65Warnings.ca.gov

Auto



Part Number	Max Voltage	Amps	Ferraz/ Gould	Littelfuse	Bussmann
071902-001	32Vac	9	307007	SFE9	SFE9
071902-002	32Vac	14	307014	SFE14	SFE14

▲ **WARNING:** Cancer and reproductive harm - www.P65Warnings.ca.gov

Fast Acting

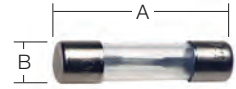

Part Number	Amp	Max Voltage	Type	Littelfuse	Bussmann	A in	B in
084190	1/4	250	AGX	361.250	AGX1/4	1.0	0.25

▲ **WARNING:** Cancer and reproductive harm - www.P65Warnings.ca.gov

Medium-Acting Radial Leaded Ceramic

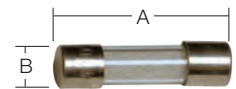

Part Number	Amp	Max Voltage	A mm	B mm	Littelfuse
052071-001	0.63	80	20	5	2010630
052071-002	2	100	20	5	234002
052071-003	10	100	20	5	234010

Fast Acting



Part Number	Max Voltage	Amp	Ferraz/ Gould	Littelfuse	Bussmann	A in	B in
094362-005	250Vac/125Vdc	3/8	GAB3/8	314.375	ABC3/8	1.25	0.25
094362-004	250Vac/125Vdc	3/4	GAB3/4	314.75	ABC3/4	1.25	0.25
094362-003	250Vac/125Vdc	2	GAB2	314.002	ABC2	1.25	0.25
094362-008	250Vac/125Vdc	3	GAB3	314.003	ABC3	1.25	0.25
094362-001	250Vac/125Vdc	4	GAB4	314.004	ABC4	1.25	0.25
094362-006	250Vac/125Vdc	5	GAB5	314.005	ABC5	1.25	0.25
094362-012	250Vac/125Vdc	6	GAB6	314.006	ABC6	1.25	0.25
094362-013	250Vac/125Vdc	8	GAB8	314.008	ABC8	1.25	0.25
094362-010	250Vac/125Vdc	10	GAB10	314.010	ABC10	1.25	0.25
094362-002	250Vac/125Vdc	15	GAB15	314.015	ABC15	1.25	0.25
094362-007	125Vac/125Vdc	30	GAB30	314.030	ABC30	1.25	0.25
094362-009			Shorting Bar		NCC	1.25	0.25

▲ **WARNING:** Cancer and reproductive harm - www.P65Warnings.ca.gov

Fast Acting



Part Number	Max Voltage	Amp	Ferraz/ Gould	Littelfuse	Bussmann	A in	B in
094362-011	250Vac or less	1	GSA1	326001	MDA1	1.25	0.25
094362-017	250Vac or less	15	GSA15	326015	MDA15	1.25	0.25
094362-020	250Vac or less	20	GSA20	326020	MDA20	1.25	0.25
340052-025	250Vac or less	25	GSA25	326025	MDA25-R	1.25	0.25

▲ **WARNING:** Cancer and reproductive harm - www.P65Warnings.ca.gov

Ferrule - High Speed, Without Striker



Part Number	Max Voltage	Amps	Ferraz/ Gould	Littelfuse	Bussmann
340096-050	700	50			FWP-50A22F

Low Voltage, Time Delay, Supplementary



Part Number	Max		Ferraz/		
	Voltage	Amps	Gould	Littelfuse	Bussmann
066052-002	250Vac or less	2.5	FNM-2.5	FLM-2.5	FLM02.5T
340042-004	250Vac or less	4	FNM-4	FLM-4	FNM-4
340042-005	250Vac or less	5	FNM-5	FLM-5	FNM-5
340042-006	250Vac or less	6	FNM-6	FLM-6	FNM-6
340042-010	250Vac or less	10	FNM-10	FLM-10	FNM-10
340042-030	125Vac or less	30	FNM-30	FLM-30	FNM-30

▲ **WARNING:** Cancer and reproductive harm - www.P65Warnings.ca.gov

One Time General Purpose Fuse



Part Number	Max		Ferraz/		
	Voltage	Amps	Gould	Littelfuse	Bussmann
090125	250Vac	30	OT-30	NLN-30	NON-30
340050-060	250 Vac	60	OT-60	NLN-60	NON-60

▲ **WARNING:** Cancer and reproductive harm - www.P65Warnings.ca.gov

Low Voltage, Time-Delay, Branch Circuit, Rejection Type



Part Number	Max		Ferraz/		
	Voltage	Amps	Gould	Littelfuse	Bussmann
340041-025	600Vac or less	0.25	FNQ-R-.25	FLQ-R-.25	FNQ-R-.25
340041-050	600Vac or less	0.5	FNQ-R-.5	FLQ-R-.5	FNQ-R-.5
340041-001	600Vac or less	1	FNQ-R-1	FLQ-R-1	FNQ-R-1
340041-035	600Vac or less	3.5	FNQ-R-3.5	FLQ-R-3.5	FNQ-R-3.5

▲ **WARNING:** Cancer and reproductive harm - www.P65Warnings.ca.gov

Low Voltage, Fast Acting, Branch Circuit, Rejection Type



Part Number	Max		Ferraz/		
	Voltage	Amps	Gould	Littelfuse	Bussmann
340037-005	600Vac or less	1	ATMR1	KLK-R-1	KTK-R-1
340037-001	600Vac or less	1.5	ATMR1.5	KLK-R-1.5	KTK-R-1.5
340037-004	600Vac or less	4	ATMR4	KLK-R-4	KTK-R-4
340037-012	600Vac or less	12	ATMR12	KLK-R-12	KTK-R-12
340037-015	600Vac or less	15	ATMR15	KLK-R-15	KTK-R-15

▲ **WARNING:** Cancer and reproductive harm - www.P65Warnings.ca.gov

Low-Peak CC TD



Part Number	Max		Ferraz/		
	Voltage	Amps	Gould	Littelfuse	Bussmann
340030-003	150Vdc-300Vdc-600Vdc	3	ATDR3	KLMR3	LP-CC-3
340030-004	150Vdc-300Vdc-600Vdc	4	ATDR4	KLMR4	LP-CC-4
340030-005	150Vdc-300Vdc-600Vdc	5	ATDR5	KLMR5	LP-CC-5
340030-006	150Vdc-300Vdc-600Vdc	6	ATDR6	KLMR6	LP-CC-6
340030-008	150Vdc-300Vdc-600Vdc	8	ATDR8	KLMR8	LP-CC-8
340030-010	150Vdc-300Vdc-600Vdc	10	ATDR10	KLMR10	LP-CC-10
340030-015	150Vdc-300Vdc-600Vdc	15	ATDR15	KLMR15	LP-CC-15
340030-020	150Vdc-300Vdc-600Vdc	20	ATDR20	KLMR20	LP-CC-20
340030-030	150Vdc-300Vdc-600Vdc	30	ATDR30	KLMR30	LP-CC-30

▲ **WARNING:** Cancer and reproductive harm - www.P65Warnings.ca.gov

RK5 TD



Part Number	Max		Ferraz/		
	Voltage	Amps	Gould	Littelfuse	Bussmann
340018-005	600	5	TRS5R	FLSR-R5	FRS-R5
340018-006	600	6	TRS6R	FLSR-R6	FRS-R6
340018-007	600	7	TRS7R	FLSR-R7	FRS-R7
340018-008	600	8	TRS8R	FLSR-R8	FRS-R8
340018-010	600	10	TRS10R	FLSR-R10	FRS-R10
340018-012	600	12	TRS12R	FLSR-R12	FRS-R12
340018-015	600	15	TRS15R	FLSR-R15	FRS-R15
340018-017	600	17.5	TRS17-1/2R	FLSR-R17-1/2	FRS-R17-1/2
340018-020	600	20	TRS20R	FLSR-R20	FRS-R20
340018-025	600	25	TRS25R	FLSR-R25	FRS-R25
340018-030	600	30	TRS30R	FLSR-R30	FRS-R30
340018-035	600	35	TRS35R	FLSR-R35	FRS-R35
340018-040	600	40	TRS40R	FLSR-R40	FRS-R40
340018-045	600	45	TRS45R	FLSR-R45	FRS-R45
340018-050	600	50	TRS50R	FLSR-R50	FRS-R50
340018-060	600	60	TRS60R	FLSR-R60	FRS-R60

▲ **WARNING:** Cancer and reproductive harm - www.P65Warnings.ca.gov

Class H



Part Number	Max		Ferraz/		
	Voltage	Amps	Gould	Littelfuse	Bussmann
340015-006	600	6	OTS6	NLS6	NOS6
340015-010	600	10	OTS10	NLS10	NOS10
340015-015	600	15	OTS15	NLS15	NOS15
340015-020	600	20	OTS20	NLS20	NOS20
340015-025	600	25	OTS25	NLS25	NOS25
340015-030	600	30	OTS30	NLS30	NOS30
340015-035	600	35	OTS35	NLS35	NOS35
340015-040	600	40	OTS40	NLS40	NOS40
340015-045	600	45	OTS45	NLS45	NOS45
340015-060	600	60	OTS60	NLS60	NOS60

▲ **WARNING:** Cancer and reproductive harm - www.P65Warnings.ca.gov

Low Peak, Dual Element, Time Delay



Part Number	Max		Ferraz/		
	Voltage	Amps	Gould	Littelfuse	Bussmann
340031-028	600Vac/300Vdc	2 ^{9/10}	AJT2 ^{9/10}	JTD2 ^{9/10}	LPJ-2 ^{9/10} S
340031-010	600Vac/300Vdc	10	AJT10	JTD10	LPJ-10SP
340031-012	600Vac/300Vdc	12	AJT12	JTD12	LPJ-12SP
340031-015	600Vac/300Vdc	15	AJT15	JTD15	LPJ-15SP
340031-020	600Vac/300Vdc	20	AJT20	JTD20	LPJ-20SP
340031-025	600Vac/300Vdc	25	AJT25	JTD25	LPJ-25SP
340031-030	600Vac/300Vdc	30	AJT30	JTD30	LPJ-30SP
340031-035	600Vac/300Vdc	35	AJT35	JTD35	LPJ-35SP
340031-040	600Vac/300Vdc	40	AJT40	JTD40	LPJ-40SP
340031-044	600Vac/300Vdc	45	AJT45	JTD45	LPJ-45SP
340031-050	600Vac/300Vdc	50	AJT50	JTD50	LPJ-50SP
340031-060	600Vac/300Vdc	60	AJT60	JTD60	LPJ-60SP
340031-070*	600Vac/300Vdc	70	AJT70	JTD70	LPJ-70SP
340031-080*	600Vac/300Vdc	80	AJT80	JTD80	LPJ-80SP
340031-090*	600Vac/300Vdc	90	AJT90	JTD90	LPJ-90SP
340031-150*	600Vac/300Vdc	150	AJT150	JTD150	LPJ-150SP
340031-175*	600Vac/300Vdc	175	AJT175	JTD175	LPJ-175SP
340031-225*	600Vac/300Vdc	225	AJT225	JTD225	LPJ-225SP
340031-400*	600Vac/300Vdc	400	AJT400	JTD400	LPJ-400SP

* - with terminals

▲ **WARNING:** Cancer and reproductive harm - www.P65Warnings.ca.gov

Stud MTD



Part Number	Max Voltage	Amps	Ferraz/ Gould	Littelfuse	Bussmann
132083-001	125	50	CNN50	CNN50	ANN50
340016-060	125	60	CNN60	CNN60	ANN60
340016-100	125	100	CNN100	CNN100	ANN100
132083-008	125	125	CNN125	CNN125	ANN125
132083-007	125	150	CNN150	CNN150	ANN150
340016-175	125	175	CNN175	CNN175	ANN175
132083-009	125	200	CNN200	CNN200	ANN200
340016-225	125	225	CNN225	CNN225	ANN225
340016-250	125	250	CNN250	CNN250	ANN250
132083-005	125	300	CNN300	CNN300	ANN300
340016-325	125	325	CNN325	CNN325	ANN325
340016-350	125	350	CNN350	CNN350	ANN350
132083-002	125	400	CNN400	CNN400	ANN400
132083-003	125	500	CNN500	CNN500	ANN500
132083-006	125	700	CNN700	CNN700	ANN700
132083-004	125	800	CNN800	CNN800	ANN800
340047-040	80	40	CNL40	CNL40	ANL40
340047-050	80	50	CNL50	CNL50	ANL50
340047-080	80	80	CNL80	CNL80	ANL80
340047-100	80	100	CNL100	CNL100	ANL100
340047-125	80	125	CNL125	CNL125	ANL125
340047-175	80	175	CNL175	CNL175	ANL175
340047-200	80	200	CNL200	CNL200	ANL200
340047-250	80	250	CNL250	CNL250	ANL250
380102-029	80	325	CNL325	CNL325	ANL325
340047-350	80	350	CNL350	CNL350	ANL350
340047-500	80	500	CNL500	CNL500	ANL500
340047-600	80	600	CNL600	CNL600	ANL600

⚠ WARNING: Cancer and reproductive harm - www.P65Warnings.ca.gov

T-Tron Fast Acting



Part Number	Max Voltage	Amps	Ferraz/ Gould	Littelfuse	Bussmann
340046-001	300Vac or less	70	A3T70	JLLN70	JJN70
340046-080	300Vac or less	80	A3T80	JLLN80	JJN80
340046-300	300Vac or less	300	A3T300	JLLN300	JJN300
340046-004	300Vac or less	350	A3T350	JLLN350	JJN350
340046-400	300Vac or less	400	A3T400	JLLN400	JJN400
340046-005	300Vac or less	450	A3T450	JLLN450	JJN450

⚠ WARNING: Cancer and reproductive harm - www.P65Warnings.ca.gov

High Speed Fuse



Part Number	Max Voltage	Amps	Ferraz/ Gould	Littelfuse	Bussmann
340017-080	150	80	A15QS-80-4	L15S80	FWA-80B
340017-100	150	100	A15QS-100-4	L15S100	FWA-100B
340017-150	150	150	A15QS-150-4	L15S150	FWA-150B
340017-200	150	200	A15QS-200-4	L15S200	FWA-200B
340017-250	150	250	A15QS-250-4	L15S250	FWA-250B
091344	150	300	A15QS-300-4	L15S300	FWA-300B
340017-350	150	350	A15QS-350-4	L15S350	FWA-350B
340017-400	150	400	A15QS-400-4	L15S400	FWA-400B
340017-500	150	500	A15QS-500-4	L15S500	FWA-500A

⚠ WARNING: Cancer and reproductive harm - www.P65Warnings.ca.gov

V-Fuse, Enclosed

Part Number	Max Voltage	Amps
814995-002	24	50



**Specialty Fuse -
Use in EE & ES applications**

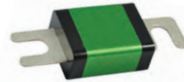

Part Number	Max Voltage	Amps	Ferraz/ Gould	Littelfuse	Bussmann
143962-001	48	500		0581500.T	
143962-002	48	800		0581800.T	
143962-003	48	50		0581050.T	
143962-004	48	125		581125	

⚠ WARNING: Cancer - www.P65Warnings.ca.gov

**Fuse Strip w/Housing for
Battery Powered Vehicles -
Fast Acting**

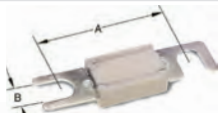

Part Number	Max Voltage	Amps	Ferraz/ Gould	Littelfuse	A mm	B mm
802816-006	80	50		157.5917.5501	60	9
806720-002	80	50		157.5701.5501	60	11
806720-003	80	80		157.5701.5801	60	11
802816-003	80	100		157.5701.6101	60	11
802816-007	80	100		157.5917.6101	60	9
802816-001	80	125		157.5701.6121	60	11
802816-005	80	125		157.5917.6121	60	9
802816-009	80	150		157.5917.6151	60	9
802816-002	80	160		157.5701.6161	60	11
802816-004	80	200		157.5701.6201	60	11
802816-011	80	355		157.5917.6351	60	9
802816-012	80	400	Z228849	157.5701.6401	60	11
806720-001	80	425		157.5701.642	60	11

Fast Acting Automotive Blade

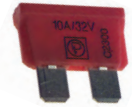

Part Number	Max Voltage	Amps	Ferraz/ Gould	Littelfuse	Bussmann	Type
805751-002	32	2	AF2	164.6185.4202	ATC2	Grey
805751-006	32	4	AF4	166.7000.440	ATC4	Pink
340077-005	32	5	AF5		ATC5	Tan
380500-223	32	7.5	AF7.5		ATC7.5	Brown
805751-001	32	10	AF10	164.6185.5102	ATC10	Red
340077-025	32	25	AF25		ATC25	Natural
340077-030	32	30	AF30		ATC30	Green
045979	32	80		299080		Clear
⚠ 062765-003	32	4		0287004		Pink
⚠ 062765-004	32	10		0287010		Red
⚠ 062765-001	32	15		0257015		Blue
806703-002	80	5		166.7000.450		Light brown
806703-004	80	10		166.7000.450		Light red
806703-001	80	15		166.7000.515		Light blue
806703-005	80	20		166.7000.520		Light yellow
806703-003	80	30		166.7000.530		Light green

⚠ WARNING: Cancer and reproductive harm - www.P65Warnings.ca.gov

Time Delay Fuse



Part Number	Max Voltage	Amps	Ferraz/ Gould	Littelfuse	Bussmann
076924-017	130	15		CCK15	ACK15
076924-018	130	20		CCK20	ACK20
076924-012	130	30		CCK30	ACK30
076924-011	130	40		CCK40	ACK40
076924-001	130	60		CCK60	ACK60
076924-003	130	100			ALS100
076924-004	130	120			ACK120A
076924-005	130	140			ACK140
076924-014	130	160			ACK160
076924-006	130	175			ACK175
076924-016	130	175			ALS175B
076924-002	130	200			ALS200B
076924-007	130	200			ACK200
076924-015	130	225			ALS225B
076924-009	130	250			ALS250B
076924-020	130	250			ACK250
076924-010	130	300			ALS300B
076924-013	130	300			ACK300
076924-021	125	300	ALS300		
076924-022	125	300	ACK300		
076924-008	125	400			ALS400B
340051-500	125	500	ALS500		

⚠ WARNING: Cancer and reproductive harm - www.P65Warnings.ca.gov

In-Line Non-Rejecting



Part Number	Max Voltage	Amps	Ferraz/ Gould	Littelfuse	Bussmann
340035-003	300Vac or less	3	SLR3	LGR3	GLR-3
340035-010	300Vac or less	10	SLR10	LGR10	GLR-10

⚠ WARNING: Cancer and reproductive harm - www.P65Warnings.ca.gov

Super-Lag Renewable

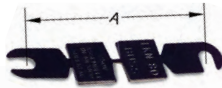

Part Number	Max Voltage	Amps	Ferraz/ Gould	Littelfuse	Bussmann	A in
381614	80	250	RL80	LKN80	LKN80	2.56
076789	125	250	RL125	LKN125	LKN125	2.625

⚠ WARNING: Cancer and reproductive harm - www.P65Warnings.ca.gov

Automotive ATM Mini Blade

Part Number	Max Voltage	Amps	Littelfuse	Type
062897-001	42	5	997005	Tan
062897-002	42	7.5	99707.5	Brown
062897-003	42	10	997010	Red
062897-004	42	15	997015	Blue
062897-005	42	20	997020	Yellow
062897-006	42	2	997002	Gray

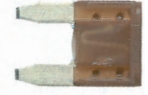

⚠ WARNING: Cancer and reproductive harm - www.P65Warnings.ca.gov

Automotive BF1

Part Number	Max Voltage	Amps	Ferraz/ Gould	Littelfuse	Bussmann	Type
153739-001	58	40		142.5631.5402		Green



⚠ WARNING: Cancer and reproductive harm - www.P65Warnings.ca.gov

Automotive Blade MAX

Part Number	Max Voltage	Amps	Ferraz/ Gould	Littelfuse	Bussmann	Type
340107-070	32	70			MAX70	Tan



J-Case, Slo-Blo Automotive Cartridge

Part Number	Max Voltage	Amps	Type	Littelfuse
062902-003	32	40	Green	995-40



⚠ WARNING: Cancer and reproductive harm - www.P65Warnings.ca.gov



Part Number - 370543

Fuse
2 Amp



Style A



Style B



Style C



Style D

OEM Key

AC = Allis Chalmers
BR = Barrett

CL = Clark
HY = Hyster
JG = Jungheinrich

KO = Komatsu
LP = LPM
MT = Mitsubishi

NI = Nissan
PM = Prime Mover
RA = Raymond

TO = Caterpillar/Towmotor
TY = Toyota
YT = Yale

Part Number	Style	Voltage	Amps	OEM		
116794-002	A	24	150	HY 800075381 LP 375-1943	LP 375-7809	TY 00591-44166-81
116794-005	A	24	150	HY 800075380 LP 375-1948	LP 375-6125	TY 00591-44171-81
110613-001	B	24	150	LP 375-1945	LP 375-3047	TY 00591-44168-81
110613-002	B	24				
110613-003	B	24	150	HY 800064625 LP 375-1946	LP 375-3048 TY 00591-44169-81	TY 00591-72323-81 YT 520293803
110613-005	B	36/48	150	HY 800075255 LP 375-1947	LP 375-3049	TY 00591-44170-81
110613-007	B	36				
117853-001	B	24	250	HY 800000537	LP 375-1073	
120975	B	24	100	LP 375-1951 LP 375-3056	TY 00591-44150-81	YT 220043708
351096-270	B	24	100	RA 313066-000		
370752	B	36/48	180	AC 3BA-55-34620 AC 8770584 BT 202170 CL 7005881 CT A0000-05433 CT A0000-09565 KO 3BA-55-34620 KO 8770584	MB A0000-05433 MB A0000-09585 PM 202170 RA 202170 TY 00591-44134-81 TY 00591-44161-81 TY 00591-57021-81 TY 00591-57055-81	TY 00591-72330-81 YT 504233261 YT 504736502
370758	B	36/48	350	CL 7006018 CT A0000-29527	MB A0000-29527 YT 580046780	
104483 ▲	C	24	150	AC 4967344 AC 4967616 AC 4967618 AC 78730634 BR 39187-001 CL 4308934 CL 7001657 CL 912089 CL 912363 CL 913903 HY 0388227 HY 2014096 HY 0388227 HY 800082018 HY 800082021	JG 14480230 JG 14520932 KO 200098 KO 24205-01 27 692-00 KO 3BA-47-A4170 KO 3WB-47-A1530 LP 375-7100-GE MT 9712402600 MT 97C5701100 PM 7692-00 PM 200098 PM 27692 RA 1-105-204 TO 9712402600	TO 97C5701100 TY 00591-04280-81 TY 00591-23819-81 TY 00591-30734-81 TY 00591-51694-81 TY 00591-30736-81 YT 501227249 YT 504227249 YT 505075506 YT 220023787 YT 220073460 YT 800082018 YT 800082021
111634 ▲	C	24	100	CL 914626 HY 800082008 LP 375-7117-GE	NI CK914626 PM 201348 PM QU-IC2800M254C4B	TY 00591-23809-81 TY 0059-136799-81 TY 0059-151676-81
370233	C	24	300	YT 505075522		
093575	D	24		CL 7001616 LP 375-6121 LP 375-6121-GE	PM 201354 PM QU-IC0M611AA13A TO 216138	TY 00591-30691-81 TY 00591-51691-81 YT 220003286
093576	D	24		CL 7001619 LP 375-6006	TY 00591-30695-81	YT 220003287
093574	D	24		LP 375-6129 PM 201356	PM QU-IC0M611AC13A TY 00591-30692-81	YT 220003285
112329	D			CL 7001619 LP 375-6006	TY 00591-30695-81	YT 220003287
112329-002	D					
116962	D			HY 800075391	LP 375-7833	
112328	D			HY 800076791	LP 375-6008	
112327 ▲	D			HY 800020423	LP 375-6007	

▲ WARNING: Cancer and reproductive harm - www.P65Warnings.ca.gov

Contactors



Style E



Style F



Style G



Style H



Style I



Style J

OEM Key

AC = Allis Chalmers
BR = Barrett

CL = Clark
HY = Hyster
JG = Jungheinrich

KO = Komatsu
LP = LPM
MT = Mitsubishi

NI = Nissan
PM = Prime Mover
RA = Raymond

TO = Caterpillar/Towmotor
TY = Toyota
YT = Yale

Part Number	Style	Voltage	Amps	OEM		
104140	E	24	150	BR 28841-654 BR 39186-001 CL 912091 KO 3WB-47-A1540 KO GA150AH124XN LP 375-7101-GE	PM 200100 PM 26673-02 PM 27693-02 TO 97124-02800 TY 00591-30732-81	TY 00591-51695-81 YT 220015003 YT 220023784 YT 5042242-80 YT 5050755-07
106109-001 ⚠	E	36	150	AC 8730877 CL 912094 HY 3055351 HY 388016 LP 375-7118-GE	NI CK912094 PM 202169 PM 27693-04 YT 220023785 TY 00591-23814-81	TY 00591-36801-81 TY 00591-57039-81 TY 00591-60549-81
106109-003 ⚠	E	36-48	150	CL 915631 HY 1300938 HY 800082014 LP 375-7113-GE	MT 97122-06600 TO 9712206600 TY 00591-23815-81	TY 00591-30733-81 TY 00591-57037-81 YT 220026251
370534	E	24	330	AC 312258-000 AC OP03000407 CT 1050553 CT 300A-24B1M25RS00-25D CT 300A-24B1M4RS01-30E CT 300A-24B5M48RS02-18A CT NA013405 CT NA015455	KO 312258-000 KO OP03000407 MB 1050553 MB 300A-24B1M4RS01-30E MB 300A-24B5M48RS02-18A MB NA013405 MB NA015455 RA 1-105-122	RA 1-105-128/100 RA 1-105-153/100
118396	F	24	150	HY 800075421 LP 375-1949	LP 375-3018	TY 00591-44144-81
370153	G	36		CL 444238 CT 0083636 CT 0399717	MB 0083636 PL 66-061 PL HB409KC360EA	PL JAF-4004D TY 00591-20262-81 YT 220013711
380030-002	H	24		HM CTR-24-280	YT 519832602	YT DC88-207
380030-085	I	36		TY 24420-13300-71		
370732	I	36		CL 448606	TY 24410-13301-71	
370743	I	36		TY 24410-12230-71		
380030-086	J	24		HY 2305835 HY 2307724	YT 505175502	YT 505175504

⚠ **WARNING:** Cancer and reproductive harm - www.P65Warnings.ca.gov

Contactor Tip and Tip Kits



Part Number - 370183

Contactor Tip

▼ OEM Reference

CL 7000194	NI 29348-L4005GN	TY 00591-31635-81
CT 218004	NI 29366-40H10	TY 00591-32654-81
DS P115-0011	TB 10-1131	TY 00591-51875-81
HY 3000709	TC AB-MSD4-1520	UC 8015
HY 3000709T	TC ABMSD-41520	YT 220070387
KO FBMSD-41520	TC ABMSD-41521	
NI 29348-L4005	TY 00591-07282-81	



Part Number - 380030-186

Contactor Tip

▼ OEM Reference

CT 912775	HY 00591-10779-81	TY 24422-13300-71
HY 3056135	HY 00591-73486-81	YT 220024698
HY 3133098	HY 24422-13301-71	



Part Number - 380030-187

Contactor Tip

▼ OEM Reference

CT 912776	TY 24421-13300-71	YT 220027574
HY 3135696	TY 00591-10778-81	
HY 800121715	TY 24421-13301-71	



Part Number - 380030-190

Contactor Tip Kit

▼ OEM Reference

YT 24450-13300-71



Part Number - 370339

Contactor Tip Kit

▼ OEM Reference

HY 800130113	TY 04924-10220-71	TY 24470-13300-71
HY 800136872	TY 04924-10230-71	
TY 04924-10210-71	TY 24460-13300-71	



Part Number - 370072-001

Contactor Tip Kit - 450 amp

▼ OEM Reference

RA 1-105-129-111
RA 154-008-740-416
RA DS223295
RA DS232734



Part Number - 370071

Contactor Tip Kit

▼ OEM Reference

DS P111-0030	PL JEA-3003S	TY 00591-07577-81
DS P111-0104	PL K2096-10	TY 00591-53115-81
HY 1316399	RA 1-105-055-02	TY 00591-57340-81
PL 67-042	RA 154-008-741-216	
PL JCA-3003S	TB 10-1K38	



Part Number - 370072

Contactor Tip Kit

▼ OEM Reference

CT 1051087	TY 00591-39838-81	YT 220017209
DS P103-0050	TY 00591-57328-81	YT 220034535
TY 00591-21059-81	HY 3039475	



Part Number - 370070

Contactor Tip Kit

▼ OEM Reference

AC 4912002	HY 3006743	TB 10-1K23
CL 996819	NK 118311	TB 10-1K27
CL 7003151	PL 67-029	TY 00591-09003-81
CL 7003190	PL JBC-3001S	TY 00591-31595-81
CT 217526	RA 1-105-023-04	TY 00591-31603-81
DS P111-0032	SC 29-10413	TY 00591-31636-81
DS P111-0044	SC 33-14640	TY 00591-51868-81
HY 3000614	SC 39-90057	TY 00591-63174-81



Part Number - 380030-084

Contactor Tip Kit

▼ OEM Reference

HY 2305749
YT 150091008



Part Number - 104651

Contact Kit

▼ OEM Reference

CL 7003192	LP 379-8233	TY 00591-60521-81
CL 919410	LP 379-8233-GE	TY 00591-60546-81
GE 154FR	PM 301741-000	TY 00591-76469-81
GE 154FR-CS	TY 00591-04237-81	YT 150091011
HY 0996112	TY 00591-23705-81	YT 220007903
HY 3054391	TY 00591-31517-81	YT 220021935
HY 996112	TY 00591-39817-81	



Part Number - 3C0003-R
Curtis PMC Control

▼ OEM Reference
FL 1205X-4417
HY 1500220-25
HY 3033962
YT 150022025
YT 518361610
YT 220015258

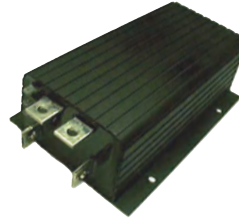

Part Number - 3C0009-R
Curtis PMC Control

▼ OEM Reference
FL 1204-001
TA CTL-2000

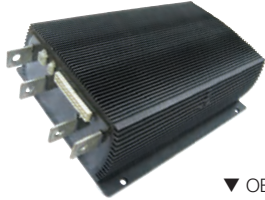

Part Number - 3C0005-R
Curtis PMC Control

▼ OEM Reference

CU 831722	HY 3175374	YT 150022574
EZ 27094G01	HY 3183796	YT 150022684
FL 1204-001	RA 1-187-085	YT 150120773
FL 1214-8708	RA 1017149	YT 220011997
FL 1214-8709	RA 1017150	YT 220175374
HY 3026554	TA CTL-2000	



Part Number - 3C0030-R
Curtis PMC Control

▼ OEM Reference
FL 77-1205-108
TA 62-205-00



Part Number - 3C0017-R
Curtis PMC Control

▼ OEM Reference
EZ 2097-G1
FL 1204-027
HY 3142096
YT 220042096



Part Number - 3C0007-R
Curtis PMC Control

▼ OEM Reference
FL 1243C-4278
HY 1674663
RA 312668-001
RA 939-353-059
YT 52437009



Part Number - 3C0018-R
Curtis PMC Control

▼ OEM Reference
BR 27732-068
FL 1205-111
HY 3026561
YT 150022580
YT 220012004



Part Number - 3C0031-R
Curtis PMC Control

▼ OEM Reference
FL 77-1243C-4384
YT 580030492



Part Number - 3C0002-R
Curtis SX Control

▼ OEM Reference
FL 1244-4467
HY 3183244
RA 1-187-094/005
TY 00590-45652-71
YT 150114996



Part Number - 3C0004-R

Curtis SX Control

▼ OEM Reference
 FL 1244-4424
 HY 3174204
 RA 1-187-094/003
 YT 150022698
 YT 220174204



Part Number - 3C0025-R

Curtis SX Control

▼ OEM Reference
 FL 1242-4204
 HY 3144453
 PM 305878-000
 YT 150022689



Part Number - 3C0026-R

24V 300A Combi Semi Control-R

▼ OEM Reference
 FL FC2364
 YT 524302946



Part Number - 3C0015-R

1204X-4215 Curtis PMC Control-R

▼ OEM Reference
 FL 1204X-4215
 RA 1-187-070



Part Number - 3C0022-R

Regen SX Control

▼ OEM Reference
 CL 7006590
 GE IC3645SR3R4U4N2
 GE IC3645SR4U404N2
 HY 3172279
 YT 150022014
 YT 580011153



Part Number - 3C0023-R

Regen SX Control

▼ OEM Reference
 FL GEIC3645SR4W606N6
 FL IC3645SR4W606N6
 GE IC3645SR4W606N6
 HY 1459800
 HY 3177464
 YT 150022016
 YT 580007805



Part Number - 3C0028-R

Controller Drive

▼ OEM Reference
 RA 312668-002
 TY 00590-43460-71



Part Number - 3C0012-R

EV100 ZX Traction Card-R

▼ OEM Reference

FL IC3645LXCD12H	HY 1459419	YT 150021994
GE IC3645LXCD1ZH	HY 3039525	YT 220021426
HY 1397304	HY 3126503	YT 580006862



Part Number - 3C0013-R

Easi Reach Power Card-R

▼ OEM Reference

FL 154-012-429/103	RA 154-012-429/103	RA 154-012-430/006
HY 3178786	RA 154-012-429/104	RA 154-012-430/007
RA 154-012-429/102	RA 154-012-430/004	YT 150050137



Part Number - 3C0014-R

Easi Reach Coil Driver-R

▼ OEM Reference

FL 828-004-206/003
 HY 3178790
 RA 828-004-206/003
 RA 828-004-207/001
 YT 150050141



Part Number - 370522

Card Assembly - Circuit

▼ OEM Reference

BT 1098272/001
 PM 1098272/001
 RA 1098272/001

Cards



Part Number - 3C0016-R

24V MPB SX Zapi Control-R

▼ OEM Reference
 FL 66-FC2086A
 HY 2045951
 YT 585098300

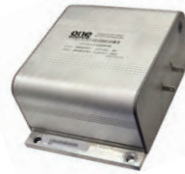

Part Number - 3C0027-R

Control Card

▼ OEM Reference
 GE IC3645SE68300GN1
 GN 1263633



Part Number - 3C0029-R

Zapi Control

▼ OEM Reference
 FL 66-FC21250A
 HY 2055599
 YT 524169972

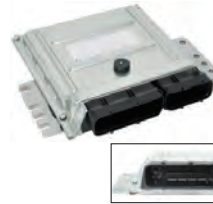

Part Number- 380030-234

Control Module Assembly

▼ OEM Reference
 CT 91E20-21500
 MB 91E20-21500
 NI 23710-GY31B



Part Number - 3C0032-R

Zapi Control

▼ OEM Reference
 BR 29310-FS120
 FL 66-FC2254-120



Part Number - 380030-235

Control Module Assembly

▼ OEM Reference
 CT 91E20-01500
 MB 91E20-01500
 NI 23710-GY360



Part Number - 380030-230

Controller

▼ OEM Reference
 YT 582024006



Part Number - 380030-236

Control Module Assembly

▼ OEM Reference
 CT 93G20-00300
 MB 93G20-00300
 NI 23710-GY470

DC/DC Converters



Part Number - 110979

- Operates 12V
- UL recognized
- Input voltage range: 18v minimum, 55v maximum
- Output current: 5 amp
- Not suitable for solid state electronics



Part Number - 128652

- Operates 12V
- UL recognized
- Input voltage range: 36v minimum, 48v maximum
- Output current: 21-23 amps
- Input over and under voltage protection
- Input polarity protection
- Input spike protection
- Output short circuit protection
- Thermal protection
- Suitable for all electronics



Part Number - 370308

- 36/48v to 12 v
- Output power 300 W

▼ OEM Reference
 HY 2066643

Note: Replacement connector requires -
 Qty 1 - 062988-004 Connector and Qty 4 - 370308-003 Contact

Replacement Parts:

Input fuse: 094362-002
 Output fuse: 062765-001

▲ WARNING: Cancer and reproductive harm - www.P65Warnings.ca.gov

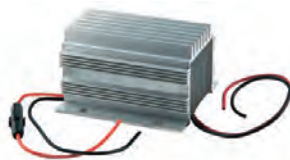

Part Number - 398000-156

- 18-50VDC to 13VDC, 10A

▼ OEM Reference
 HY 3039168
 TY 00591-21147-81



Part Number - 079549

Solenoid

12 Volt, Curved Bracket,
Heavy Duty Intermittent

▼ OEM Reference

AC 22226-02	HY 3002952	RA 308202-000
AC 4614761	HY 3003159	RA 590-011
AC 4814761	HY 3007041	RA 590-111
AC 4905994	HY 3013430	RA 850-103-154
AC 4912911	HY 3052337	RA 939-339
AC 74912911	HY 3053657	SC 33-02018
AC OP03001514	HY 3056864	SC 41-25015
AT 3324	HY 3131991	TC 22226-02
AT 3325	HY 3132337	TC A11467
BC 1013609CC	HY 3139728	TC CK896553
BJ 20417	HY A130188C	TC P-20142
BJ 20419	HY A130188O	TC P-2226-2
BJ 2833	HY A26078	TY 00591-04797-81
BK 12MP2212	JL 2222602	TY 00591-06511-81
BK 12MP2212V	JL 2222602PM	TY 00591-32096-81
BK 130785	KM 90007211	TY 00591-32097-81
BK 988628	KM C903510	TY 00591-32100-81
BK 993971	KO 22226-02	TY 00591-32101-81
BK EP2112EE	KO 22226-04	TY 00591-32107-81
BK EP21EX	KO 4614761	TY 00591-41439-81
BK LN993971	KO 4814761	TY 00591-41440-81
BO 390107712	KO 4905994	TY 00591-51891-81
BR 11467-000	KO 4912911	TY 00591-51893-81
BR 988628	KO 8730425	TY 00591-51895-81
BR A11467	KO 8735533	TY 00591-53292-81
BR CK896553	KO 8736471	TY 00591-57386-81
BR CK912975	KO OP03001512	YT 015926300
BT 20142-00	KO OP03001514	YT 030121700
BT 22226-02	LI 12MP2212	YT 076504100A
BT 22226-04	LI 130785	YT 0957643BA
BT 308202-000	LI 159802	YT 0957643CA
CL 1628551	LI 988628	YT 0957643CK
CL 7003907	LI 993971	YT 150034000
CL 7003909	LI EP2112EE	YT 220012834
CL 893329	MB 0302266	YT 220023937
CL 896553	MB 0971600	YT 220031728
CL 912975	MB 0973212	YT 220035664
CL 999634	MB 0973708	YT 220051072
CL LN993971	MB 302266	YT 220051922
CT 0302266	MB 971600	YT 220051923
CT 0971600	MB 973212	YT 500203300
CT 0973212	MB 973708	YT 500218300
CT 0973708	MB A000012044	YT 501270301
CT 302266	ME 80374	YT 501270304
CT 971600	NI CK896553	YT 502265300
CT 973212	NI CK912975	YT 504903802
CT 973708	PM 20142-00	YT 510489802
CT A000012044	PM 22226-02	YT 511289100
CU 840769	PM 22226-04	YT 511489802
EZ 840769	PM 308202-000	YT 5188188-34
HM 3249	PM P-20142	YT 518818834
HY 1198733	PM P-22226-2	YT 620020100
HY 1322354	RA 22226-02	
HY 238761	RA 22226-04	

▲ WARNING: Cancer - www.P65Warnings.ca.gov



Part Number - 084343

Solenoid

24 Volt, Curved Bracket,
Heavy Duty Intermittent

▼ OEM Reference

AC 4814762	DS P100-0024	MB A000000297
AC 4913135	DW 26099	MB W205010471
AC 74814762	EZ 30807G1	ME SM7-15
AC OP03001127	HM 3179	MJ A3130
AC OP03001513	HM 3250	MJ A3131
AC OP03001513A	HY 1307121	MJ A3135
BJ 20422	HY 1322444	MJ A3139
BJ 20715	HY 238754	MT 500873341
BJ 2606	HY 294814	MT 77800437
BJ 900756	HY 3001410	MT 77800506
BK 12MP2224	HY 3002398	NI 13593-000
BK 12MP2224V	HY 3002600	NI CK1613990
BK 130803	HY 3014061	NI CK907270
BK 153947	HY 3027557	NI CK919974
BK 989897	HY 3038466	PM 134615
BK 992777	HY 3053898	PM 22201
BK 993972	HY 3054165	PM 22226-01
BK EP21-24	HY 3054368	PM 308203-000
BK EP21-24V	HY 3125730	PM INSOL-401
BK EP2124HYDY	HY 326994	RA 134615
BK EP2124REG	HY 360610	RA 22226-01
BK LN993972	JU 14157280	RA 308203-000
BK SAS4401	JU 14462820	RA 560-209-09
BR 11469-000	JU 50010973	RA 939-016
BR 13593-000	JU 77800437	RA DS226279
BR 28700-050	JU 77800506	RA INSOL-401
BR A11469	KO 22226-01	RA J77-800-437
BR A13593	KO 308203-000	SC 18-31227
BR CK1613990	KO 4814762	SC 33-02016
BR CK907270	KO 4913135	SC 41-28018
BR CK919974	KO 4960349	TC CK1613990
BR PM22226-01	KO 4960776	TC CK907270
BT 134615	KO 8730320	TY 00590-04565-71
BT 22201	KO 8733937	TY 00591-02112-01
BT 22226-01	KO 8733937A	TY 00591-02113-81
BT 22231	KO 8736077	TY 00591-03630-81
BT 308203-000	KO OP03001127	TY 00591-06514-81
BT INSOL-401	KO OP03001513	TY 00591-21048-81
BT P-22226-1	KO OP03001513A	TY 00591-21049-81
BT P22226	LI 12MP2224	TY 00591-32117-81
CL 1613990	LI 12MP2224HYDY	TY 00591-32119-81
CL 337670	LI 12MP2224V	TY 00591-41450-81
CL 773124	LI 130803	TY 00591-51900-81
CL 773296	LI 153947	TY 00591-51902-81
CL 898796	LI 989897	TY 00591-76238-81
CL 906283	LI 992777	YT 220000838
CL 907270	LI 993972	YT 220006542
CL 919974	LI EP2124	YT 220012672
CL 994686	LI EP2124HYDY	YT 220014866
CL 999639	LI EP2124REG	YT 220020167
CT 1075426	LI LN993972	YT 220021112
CT 1176440	LI SAS4401	YT 220035697
CT 213272	MB 0973650	YT 220054095
CT 215063	MB 1075426	YT 252806500
CT 77800437	MB 1176440	YT 4015930B
CT 973650	MB 213272	YT 518818835
CT A000000297	MB 215063	YT 57958800
CT W205010471	MB 77800437	YT 580031193
CU 30807G1	MB 973650	

▲ WARNING: Cancer - www.P65Warnings.ca.gov

Solenoids



Part Number - 370327
Solenoid

▼ OEM Reference

BR PM22226-05	HY 800140689	RA 22226-05
BT 22226-05	PM 22226-05	RA 851-200-443

▲ **WARNING:** Cancer - www.P65Warnings.ca.gov



Part Number - 077157-001
Solenoid
 36 Volt, Flat Bracket with Insulator, Continuous Duty

▼ OEM Reference

CL 1636581	PL 15-261	TY 00591-51898-81
CT 972885-ORG	PL 15-334	TY 00591-51899-81
HY 260574	PL 15-376	WH 70-120224-5
HY 260575	PL SAS-4301	WH 71-120224-5B1-ORG
HY 260576	PL SAS-4303	YT 074298100
HY 278111-ORG	PL SAS-5303-A	YT 220003303
HY 3030124-ORG	PL SAS-5303-B	YT 220013134
HY 3053003	PL SAS-5303A	YT 501270306
HY 327058	PL SAS-5303B	YT 580000235
MB 972885-ORG	TY 00591-06513-81-ORG	YT 742981
NI CK1636581-ORG	TY 00591-32120-81	
PL 15-242	TY 00591-32126-81	

▲ **WARNING:** Cancer - www.P65Warnings.ca.gov



Part Number - 370197
Solenoid
 24V, Straight Bracket

▼ OEM Reference

TY 00590-43462-71



Part Number - 077157-002
Solenoid
 24V, Flat Bracket, Continuous Duty

▼ OEM Reference

AC 22226-3	DR 1115636	PM 22226-03
BT 132160	KO 22226-03	RA 22226-03
BT 22226-03	PM 132160	RA 590118

▲ **WARNING:** Cancer - www.P65Warnings.ca.gov



Part Number - 370314
Solenoid
 24V

▼ OEM Reference

BT 560-213/06
PM 560-213/06
RA 560-213/06



Part Number - 370322
Solenoid
 24V-WR

▼ OEM Reference

AC OP03001086	KO 23452-01	NI PM2345201
BR PM23452-01	KO 8730162	PM 23452-01
BT 23452-01	KO 8734702	RA 23452-01
CL 919743	KO OP03001086	

Battery Capacity Indicators & Hour Meters Continued ▶

Part Number	Voltage	Body Diameter	Overall Length	Lens	Display
130997	12-24	66.7mm (2.63")	52mm (2.05")	Glass	Hour Meter
824819	24-48	69mm (2.73")	52mm (2.05")		99999.9 LCD BDI - LED



Combines in one instrument a completely solid state battery discharge indicator, an LCD hour meter and lift lockout, housed in a 52 mm case. Indicates state of charge in 10 bar LED display. Void of moving parts, this instrument is exceptionally reliable even in severe operating environments. Suitable for all electric vehicles. Mounting hardware included.

Note: All round gauges utilize an industry standard mounting hole.



Part Number	Voltage	Lens	Display
370005	12-24		BDI, Hour Meter

▼ OEM Reference

HY 2046546
YT 580026708



Part Number	Voltage	Lens	Display
370092	24-36		BDI, Hour Meter

▼ OEM Reference

BT 301445-000	HY 864794	RA 939-122
CL 448375	KO 301445-00	TY 00590-00528-71
CL 7000601	KO 301445-000	TY 00590-00609-71
CL 913739	MB 1009518	TY 00590-00610-71
CL 917966	MB 1100728	TY 00590-03794-81
CL 919749	PM 23268-01	TY 00590-09015-81
CT NAO17474	PM 301445-000	TY 00590-42119-71
CT 1009518	RA DS226823	TY 00591-03794-81
CT 1100728	RA DS226824	TY 00591-09015-81
HY 0864794	RA 850-139-183-004	YT 220029245
HY 1361313	RA 870-231-002	YT 220037690
HY 2046257	RA 870-231-003	YT 524148929
HY 3057690	RA 870-248	YT 752060402
HY 3137245	RA 870-256	YT 752626302

Battery Capacity Indicators & Hour Meters



Part Number	Voltage	Vendor Number
134527	24	Curtis 933
134528	36	Curtis 933
134529	24-36-48	Curtis 933

Controller with lift lockout and adjustable reset and discharge settings. It features a rugged aluminum controller for reliable operation, even in the most severe conditions. It prolongs battery life and protects vehicle components from the effects of deep discharge in material handling and other battery powered vehicles. Use in conjunction with part number 153830.

Part Number	Voltage	Lens	Display
129042	36-48	Lexan	BDI, Hour Meter, LCD



Overall Length	Body Diameter
91.69 mm (3.61")	62.23mm (2.45")

Displays various system parameters, such as battery state of charge, operation hours, event code, and 10K light. Used on FC4. Battery charge light, when on, shows the percent of charge left in the battery. It will flash to warn you of a low battery charge. When key is turned off, the display will show total hours of truck operation. Used on trucks with two controllers.



Part No.	Voltage	Lens	Display
153830	24-48	Polycarbonate	LED

Overall Length	Body Diameter
54mm (2.13")	58.5mm (2.30")

Discharge meter, use in conjunction with 134527, 134528 and 134529 battery interrupts. Hardware to mount included.

Part Number	Voltage	Lens	Display
124819	36	Lexan	BDI, Hour Meter, LCD



Overall Length	Body Diameter
91.69 mm (3.61")	62.23mm (2.45")

Displays various system parameters, such as battery state of charge, operation hours, event code, and 10K light. Used on FC4 & SC4. Battery charge light, when on, shows the percent of charge left in the battery. It will flash to warn you of a low battery charge. When key is turned off, the display will show total hours of truck operation.

Part Number	Voltage	Lens	Display
115083	12-24	Lexan	LED
106288	24-36		LED
126238-002*	24-36		LED



Overall Length	Body Diameter
64mm (2.53")	52mm (2.05")

Dual voltage, easy to install "fuel" gage. Reliable, accurate and easy to read display of battery state-of-charge. For lead acid battery-powered vehicles that require a display function only. Mounting hardware included.

*Note: Maintenance-free batteries.



Part Number	Voltage	Hardware
113773-001	12-48	Bracket/Nuts
113773-003	12-48	Mounting Ring

Overall Length	Body Diameter	Display
38mm (1.48")	52mm (2.05")	9999.9

Kit (P.N. 114254) includes 113773-001 and red/white lead.

Highly reliable solid state hour meter that offers an unprecedented combination of patented technology, performance, reliability and value. It has a provision for continuous display. Has LCD display. DC only. Mounting hardware included. Signal input positive.

Part Number	Voltage	Type	Lens	Display
130600-001	12	Standard	Glass	Hour Meter 8 alpha-numeric, LCD, BDI-LED
130600-002	12	Freezer	Glass	



Overall Length	Body Diameter
64mm (2.53")	52mm (2.05")

Displays various system parameters, such as battery state-of-charge, operation hours or maintenance status from a motor controller or other serial communication source. Ideal for pallet trucks, walkies, stackers and order pickers as well as other equipment with a need to display data using a dedicated unidirectional asynchronous serial signal. Mounting hardware included.



Part Number	Voltage	Display
113773-004	12-48	9999.9

Overall Length	Body Diameter
34mm (1.318")	31mm x 54mm (1.224" x 2.098")

Highly reliable solid state hour meter that offers an unprecedented combination of patented technology, performance, reliability and value. It has a provision for continuous display. Has LCD display. DC only. Utilizes flat quick-connect terminal tabs with hole.

**Frame and Undercarriage -
LW & Lift Linkage**



○ Current parts available from Crown

1 - Load Wheel Assembly, High Load (95A)
P.N. 310245-302-88
▼ OEM Reference
HY 2046051-A
HY 2046054-A
HY 2046054-A1
HY 524250486
YT 582010234

2 - Load Wheel
P.N. 310245-xxx
▼ OEM Reference
HY 2046054
YT 524148750

3 - Wheel Bearing
P.N. 311000-006
▼ OEM Reference
HY 2046055
YT 524148751

4 - Bushing/String Guard
P.N. 370142
▼ OEM Reference
HY 2046056
YT 524148752

5 - Fork Riser
P.N. 370010
▼ OEM Reference
HY 2046053
YT 524148749
YT 524250478

6 - Exit Roller
P.N. 370017
▼ OEM Reference
HY 2307475
HY 3000693
HY 3003759
HY 3006938
YT 64857600
YT 220053022
YT 751791300

7 - Grease Fitting
P.N. 100779 ⚠
▼ OEM Reference
HY 3050200
HY 3050288
YT 22783500
YT 31459100
YT 220001019
YT 220016295
YT 503828100
YT 524148462

8 - Load Wheel Axle
P.N. 370009
▼ OEM Reference
HY 2046057
YT 524148753

9 - Pivot Pin
P.N. 370107
▼ OEM Reference
HY 2039119
HY 2040200
HY 2046263
YT 524140839
YT 524141201
YT 585096306

10 - Pivot Pin
P.N. 370001
▼ OEM Reference
HY 2046264
HY 2072211
YT 524221067
YT 585096307

11 - Spiral Pin
P.N. 060000-068 ⚠
▼ OEM Reference
HY 2046059
HY 2307242
HY 3014372
YT 220008856
YT 220023535
YT 220037894
YT 220050279
YT 501985905
YT 524148755

12 - Pin Coiled
P.N. 370262
▼ OEM Reference
HY 2050087
HY 2050088
YT 585096801
YT 585096802

13 - Grease Fitting
P.N. 370120
▼ OEM Reference
HY 2025757
HY 2040833
HY 2305757
HY 2790462
HY 3041021
HY 3131315
YT 220005338
YT 220022915
YT 273033400
YT 449076005

14 - Push Rod
P.N. 370016
▼ OEM Reference
HY 2046286
HY 2085540
YT 585094505

15 - Pivot Pin
P.N. 370045
▼ OEM Reference
HY 2046260
HY 2046262
YT 524221064
YT 585096303
YT 585096305

16 - Pivot Pin
P.N. 370044
▼ OEM Reference
HY 2046259
YT 585096302

17 - Pin Coiled
P.N. 370262
▼ OEM Reference
HY 302467
HY 2050087
HY 2050088
YT 585096801
YT 585096802

19 - Lower Rear Link RH
P.N. 370036
▼ OEM Reference
HY 2050086
YT 524144864

20 - Lower Rear Link LH
P.N. 370037
▼ OEM Reference
HY 2050085
YT 524144865

21 - Riser, Wheel and Axle Assembly
P.N. 370013
▼ OEM Reference
HY 2043251
HY 4018767
YT 524143966
YT 524243135
YT 524328746
YT 582007340

22 - Load Wheel and Axle Assembly
P.N. 360038-176
▼ OEM Reference
HY 800127595
YT 150118854
YT 800127595

⚠ WARNING: Cancer and reproductive harm - www.P65Warnings.ca.gov

Frame and Undercarriage

1 - Poly Load Wheel

P.N. 310185-302

▼ OEM Reference
HY 3005911

2 - Bearing

P.N. 311000-004

▼ OEM Reference
HY 124624

5 - Load Wheel Axle w/Lube Fitting

P.N. 370046

▼ OEM Reference
HY 3005736

6 - Lube Fitting

P.N. 370292

▼ OEM Reference
HY 13957

7 - Roll Pin

P.N. 060000-068 ▲

▼ OEM Reference
HY 2307242

8 - Pivot Pin

P.N. 370027

▼ OEM Reference
HY 2309397

9 - Roll Pin

P.N. 060000-024

▼ OEM Reference
HY 2307086

10 - Fork Riser w/ Lube Fitting

P.N. 370050

▼ OEM Reference
HY 2302730

15 - Lube Fitting

P.N. 100779 ▲

▼ OEM Reference
HY 16041

21 - Link

P.N. 370020

▼ OEM Reference
HY 2307680

27 - Roll Pin

P.N. 060000-104 ▲

▼ OEM Reference
HY 19913

11 - Riser Assembly w/Load Wheel & Axle

P.N. 360038-131

▼ OEM Reference
HY 2302730-A
YT 065771100

16 - Push Rod, 48" Forks

P.N. 370022

▼ OEM Reference
HY 2308822

22 - Retaining Ring

P.N. 060009-005 ▲

▼ OEM Reference
HY 58903

28 - Pin

P.N. 370023

▼ OEM Reference
HY 2311661

12 - Exit Roller

P.N. 370017

▼ OEM Reference
HY 2307475

17 - Spacer

P.N. 360038-264

▼ OEM Reference
HY 2311881
YT 751776300

23 - Nut

P.N. 060021-009

▼ OEM Reference
HY 15001
HY 15055

32 - Bellcrank Pin, 27" Wide Forks

P.N. 370032

▼ OEM Reference
HY 2309006

13 - Link Pin

P.N. 370018

▼ OEM Reference
HY 3006808

19 - Pin, Push Rod

P.N. 370049

▼ OEM Reference
HY 3008398

25 - Pin

P.N. 370047

▼ OEM Reference
HY 2305824

34 - Nut

P.N. 060021-009

▼ OEM Reference
HY 15001
HY 15055

14 - Roll Pin

P.N. 060000-024

▼ OEM Reference
HY 2307086

20 - Pin

P.N. 370021

▼ OEM Reference
HY 2304484

26 - Hex Bolt

P.N. 060016-004

▼ OEM Reference
HY 18497

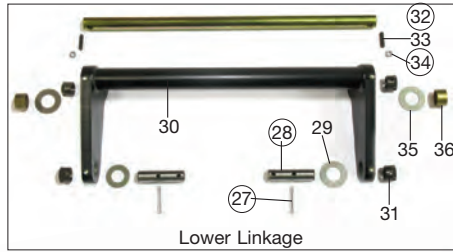

Lower Linkage

○ Current parts available from Crown

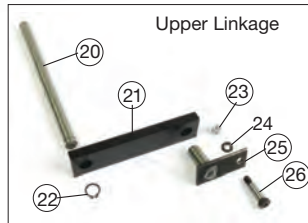
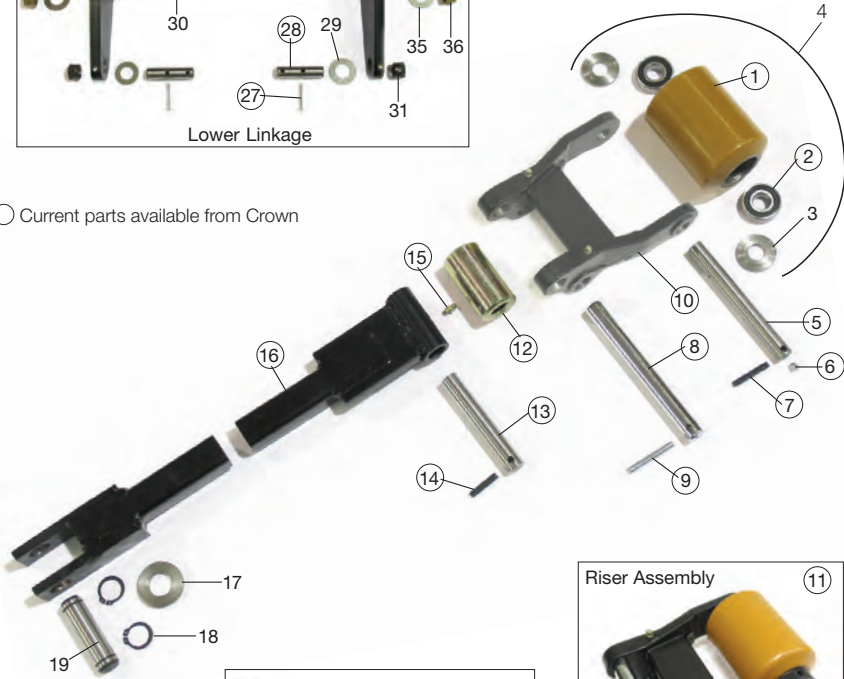

Upper Linkage



Riser Assembly

▲ WARNING: Cancer and reproductive harm - www.P65Warnings.ca.gov

Frame and Undercarriage

2 - Washer

P.N. 370501-070

▼ OEM Reference
RA 5-018-006

3 - Washer - Lock Kit

P.N. 370501-055

▼ OEM Reference
RA 5-019-006

4 - Shaft

P.N. 351096-200

▼ OEM Reference
RA 1026383

5 - Roller - Pallet

P.N. 370615

▼ OEM Reference
RA 360-067-004

6 - Pivot Shaft

P.N. 360038-267*

▼ OEM Reference
RA 1026637*

7 - Block - Pivot LH

P.N. 370501-302*

P.N. 370501-294**

▼ OEM Reference
RA 1026378-001*
RA 1026378-002**

8 - Screw

P.N. 360038-207

▼ OEM Reference
RA 714-145

9 - Spacer, Tube

P.N. 370180*

▼ OEM Reference
RA 1045247-001*

10 - Block - Pivot RH

P.N. 370501-303*

P.N. 370501-299**

▼ OEM Reference
RA 1026377-001*
RA 1026377-002**

11 - Grease Fitting

P.N. 370292

▼ OEM Reference
RA 840-033

12 - Grease Fitting

P.N. 370159

▼ OEM Reference
RA 840-018

18 - Fork Riser

P.N. 370177*

P.N. 370178**

▼ OEM Reference
RA 1025351-002*
RA 1025353-002**

19 - Bushing

P.N. 370526*

P.N. 065117-001**

▼ OEM Reference
RA 1025348-007*
RA 1025349-007**

20 - Spacer

P.N. 380700-014

▼ OEM Reference
RA 771-033

21 - Load Wheel Axle, Single

P.N. 370122

▼ OEM Reference
RA 850-135-634

22 - Load Wheel

P.N. 310178-xxx

▼ OEM Reference
RA 632-069

23 - Bearing Non-Shielded

P.N. 042022 ▲

▼ OEM Reference
RA 441-015

24 - Bearing Shielded

P.N. 311000-006

▼ OEM Reference
RA 441-127

25 - Spiral Pin

P.N. 060000-081 ▲

▼ OEM Reference
RA 810-747

26 - Shaft - Rear Link

P.N. 370501-283*

P.N. 370598**

▼ OEM Reference
RA 1050893-001*
RA 1050893-002**

27 - Retaining Ring

P.N. 060009-037 ▲

▼ OEM Reference
RA 810-131
RA 810-132

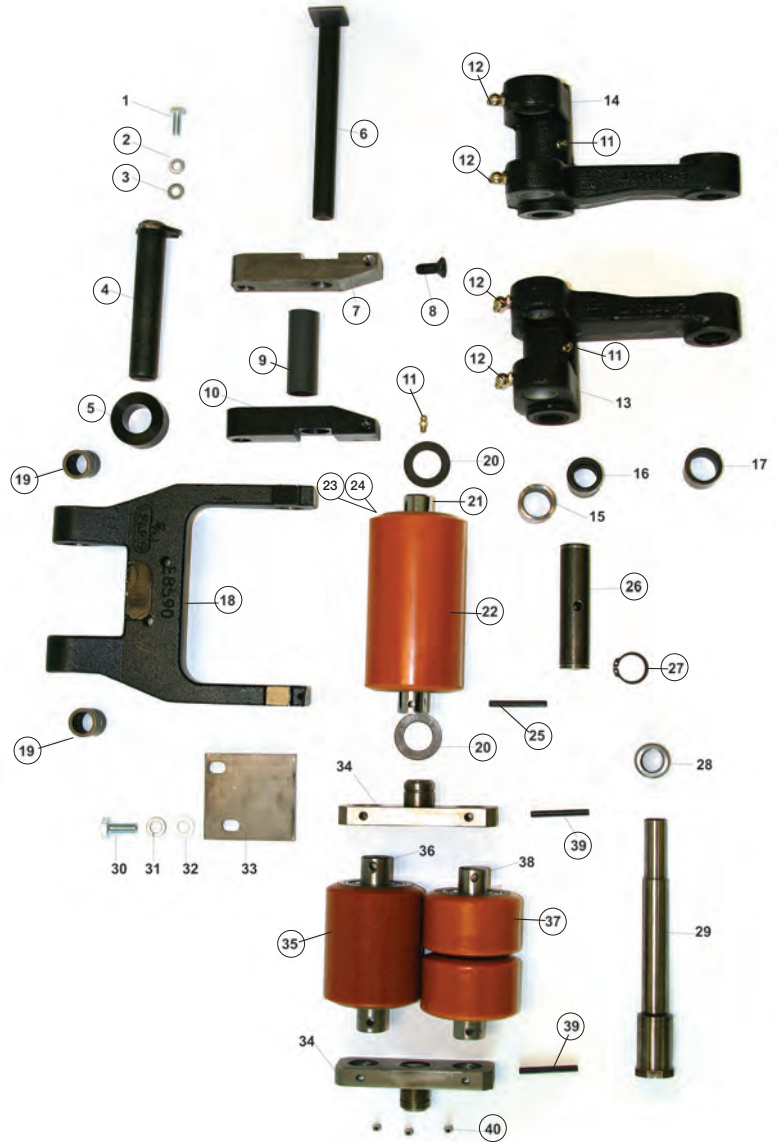

○ Current parts available from Crown

35 - Load Wheel, Tandem

P.N. 310180-xxx

▼ OEM Reference
RA 632-071

37 - Load Wheel, Tandem Split

P.N. 154840-xxx

▼ OEM Reference
RA 632-076

39 - Spiral Pin

P.N. 370066

▼ OEM Reference
RA 810-762

40 - Grease Fitting

P.N. 370121

▼ OEM Reference
RA 841-111

▲ WARNING: Cancer and reproductive harm - www.P65Warnings.ca.gov

*6,000 lbs. Capacity
**8,000 lbs. Capacity



Part Number - 370013

Riser Wheel Axle Assembly

▼ OEM Reference
HY 2043251
YT 524143966



Part Number - 370211

Fork Riser

▼ OEM Reference
JU 51076281



Part Number - 370050

Fork Riser

▼ OEM Reference

BK 992626	HY 3011678	YT 64856600
BK 992627	TY 00591-30852-81	YT 65054700
HY 2302730	TY 00591-52307-81	YT 643182400



Part Number - 370036

Lower Link (Right)

▼ OEM Reference
HY 2050086
YT 524144864

Part Number - 370037

Lower Link (Left)

▼ OEM Reference
HY 2050085
YT 524144865



Part Number - 370010

Fork Riser

▼ OEM Reference
HY 2046053
HY 2081792
YT 524148749
YT 524250478



Part Number - 370427

Link-FR Lower Assembly

▼ OEM Reference
BR 32606-014 NI 48503-FS000
BR 48503-FS000 TY 00591-38800-81
NI 32606-014 TY 00591-58635-81



Part Number - 370176

Fork Riser

▼ OEM Reference
PM 312638-000
RA 939-352-256
TY 00590-43543-71

Part Number - 370016

Push Rod 48 in. Forks

▼ OEM Reference
HY 2046286
YT 585094505



Part Number - 370177*

Fork Riser

▼ OEM Reference
RA 1025351-002
TY 00590-46291-71

Part Number - 370022

Push Rod 48 in. Forks

▼ OEM Reference
BK 992640 TY 00591-30860-81 YT 502447503
CL 7001866 YT 501771303 YT 502448503
HY 2308822



Part Number - 370178**

Fork Riser

▼ OEM Reference
RA 1025353-002
TY 00590-46288-71

*6,000 lbs. Capacity
**8,000 lbs. Capacity



Part Number - 370009

Load Wheel Axle-Steel Chromed

▼ OEM Reference
HY 2046057
YT 524148753



Part Number - 370260

Fork Riser

▼ OEM Reference
LP 763-1206
RA 1025355



Part Number - 370046

Load Wheel Axle-Steel Plain

▼ OEM Reference
BK 992629 HY 3005736 YT 220037538
CL 7001749 TY 00591-30754-81 YT 640374100
CT 218051 TY 00591-52316-81 YT 641433100
HY 2304088 TY 00591-76717-81



Part Number - 370078

Fork Riser

▼ OEM Reference
HY 2039904 YT 524141180
HY 2058037 YT 524177337



Part Number - 370189

Roller Axle - Steel Plain

▼ OEM Reference

BK L1700000	JU 3310058	MB 71305310
CT 27811190	JU 3312263	MT 3310058
CT 33122630	JU 33122630	MT 38686
CT 71305310	JU 7130531	RA 38686
HP MU38686	JU 71305310	TY 00591-43128-81
JU 2781065	MB 27811190	TY 00591-55629-81
JU 27810650	MB 33122630	



Part Number - 370075

Load Wheel Axle

▼ OEM Reference

CL 7002781	HY 2061914	YT 524187950
HY 2039868	YT 524141151	YT 524230699
HY 2039869	YT 524141153	



Part Number - 370130

Load Roller Axle-Steel Plain

▼ OEM Reference

BG 906-0013	PM 47133	RA 111257
BT 47133	PM 111257	TY 00591-43227-81
BT 111257	RA 47133	TY 00591-43588-81



Part Number - 370067

Load Wheel Axle

▼ OEM Reference

CL 7002631	TY 00591-58564-81	YT 505617500
TY 00591-38443-81	TY 00591-76605-81	



Part Number - 370095

Load Wheel Axle

▼ OEM Reference

BK LN153450
BK 153450



Part Number - 370167

Axle Entry Roller

▼ OEM Reference

HY 2039255
YT 524140913



Part Number - 370572

Load Wheel Axle

▼ OEM Reference

RA 304619-002
RA 304619-X01



Part Number - 370119

Triple Axle

▼ OEM Reference

RA 850-135-634-3
RA 850-135-634-3HL



Part Number - 370192

Wheel Axle Assembly

▼ OEM Reference

RA 623-010-297



Part Number - 370229

Load Wheel Axle

▼ OEM Reference

CT 51012680	JU 51059718	MB 51059718
CT 51059718	MB W2050-13546	
JU 51012680	MB 51012680	



Part Number - 370270

Caster Axle

▼ OEM Reference

RA 828-006-728



Part Number - 370268

Load Wheel Axle

▼ OEM Reference

RA 1014758-001



Part Number - 370224

Axle/Shaft

▼ OEM Reference

JU 33138390



Part Number - 370269

Load Wheel Axle

▼ OEM Reference

RA 1014758-002



Part Number - 370232

Shaft/Axle

▼ OEM Reference

CT 33138380
JU 33138380
MB W2050-10198
MB 33138380



Part Number - 370324

Load Wheel Axle

▼ OEM Reference

AC 304619-000	HY 800129393	PM 304619-000
BT 304619-000	KO 8734677	RA 304619-000



Part Number - 370074

Axle

▼ OEM Reference

HY 2045925
YT 524148464



Part Number - 370122

Axle

▼ OEM Reference

CL 7002767	RA 850-135-305	TY 00591-38729-81
CT 1009733	RA 850-135-634	TY 00591-58588-81
HY 3121689	RA DS226867	YT 220018798
MB 1009733	TY 00590-00020-71	



Part Number - 370123

Axle

▼ OEM Reference

CL 7001987	CT NA-013763	TY 00591-30961-81
CT 1055818	MB NA-013763	YT 220003938
CT 1055827	RA 623-010-110-002	
CT NA012942B	RA 623-010-181-002	



Part Number - 370138

Axle

▼ OEM Reference

BR 40001-FS002



Part Number - 370155

Axle

▼ OEM Reference

BK 986042	CL 7001803	TY 00591-30794-81
BK PAL18	CT 218049	TY 00591-36969-81
BK 138043	HY 3005747	TY 00591-52025-81
BK 984297	HY 3143583	TY 00591-70791-81
BK 986036	SC 21-41323	YT 220016551
BK 986042	SC 21-41520	YT 220043583
CL 7001797	SC 41-27543	YT 505340501
CL 7001802	TY 00591-30790-81	YT 505340502



Part Number - 370141

Axle

▼ OEM Reference

RA 850-139-349



Part Number - 370226

Axle

▼ OEM Reference

JU 33138370



Part Number - 370187

Axle

▼ OEM Reference

CL 7001794	MB A3448	YT 501193100
CT A3448	TY 00591-36965-81	YT 524163144
HY 2309107	TY 00591-60840-81	
HY 3005832	TY 220035767	



Part Number - 370316

Axle

▼ OEM Reference

YT 524150938



Part Number - 370193

Axle

▼ OEM Reference

HY 1450616	HY 2013153	YT 580000461
HY 1450617	TY 00591-74534-81	YT 580000462
HY 1493867	YT 519433626	YT 580024028



Part Number - 370222

Axle

▼ OEM Reference

CT 51065679	MB W205013572
JU 51065679	MB W2050-13572
MB 51065679	



Part Number - 370283

Axle - Corrosion Resistant

▼ OEM Reference

PM 313185-000
RA 939-353-127
TY 00590-43548-71

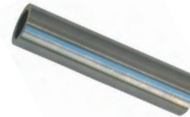

Part Number - 370076

Axle Sleeve

▼ OEM Reference

HY 2304696
YT 505034200



Part Number - 360038-267

Shaft Pivot

▼ OEM Reference

RA 1026637



Part Number - 370190

Shaft

▼ OEM Reference

CL 7002450	TY 00591-72261-81	YT 504599200
HY 2302981	YT 220049717	
TY 00591-38020-81	YT 500640818	



Part Number - 370265

Shaft Pivot

▼ OEM Reference

YT 507247500



Part Number - 370045

Pivot Pin

▼ OEM Reference
 HY 2046260 YT 585096303
 HY 2046262 YT 585096305



Part Number - 370219

Roll Pin

▼ OEM Reference
 JU 25700520



Part Number - 370261

Pivot Pin

▼ OEM Reference
 HY 2039120
 YT 524140840



Part Number - 050000-095

Roll Pin

▼ OEM Reference

AC 8730573	HY 3143377	PM 301964-032
BK LM200142000	JU 50021409	RA 301964-032
BK L1036914001	JU 50180203	SL 501898
BK L9380620220	JU 71805830	SL 5442415
BK 9380620220	KM 101359	SL 8005505
BR PM301964-032	KO 301964-032	TY 33664-13500-71
BT 301964-032	LI M200142000	WG 5505
CL 01JM04032	LI 1036914001	YT 200078120
CL 3JM4032	LI 9380620220	YT 220043377
CL 730668	MT 0200078120	YT 272204800
CL 924657	MT 0200142000	YT 449034012
HY 2035130	MT 04207867977	YT 954508909
HY 2791837	NY 30304032	



Part Number - 370174

Pivot Pin

▼ OEM Reference
 HY 2099626
 YT 524301377



Part Number - 370027

Pivot Pin

▼ OEM Reference

BK 992657	HY 2309397	TY 00591-58555-81
CL 7001856	TY 00591-30853-81	TY 00591-76570-81
CL 7002612	TY 00591-38395-81	YT 64857300
HY 2303559	TY 00591-54000-81	YT 504734200



Part Number - 370223

Roll Pin

▼ OEM Reference

CT 25700810	KO 04025-00532	MB 948810532
CT 948810532	MB 09488-10532	MB W2050-11894
JU 25700810	MB 25700810	YT 449034019



Part Number - 370001

Pivot Pin

▼ OEM Reference
 YT 585096307
 HY 2046264
 HY 524221067



Part Number - 370066

Pin Coil

▼ OEM Reference
 RA DS227111
 RA 810-762
 TY 00590-00633-71



Part Number - 370044

Pivot Pin

▼ OEM Reference
 HY 2046259
 YT 585096302



Part Number - 370262

Pin Coiled

▼ OEM Reference
 HY 2050087
 HY 2050088
 YT 585096801
 YT 585096802



Part Number - 370107

Pin - Lower Link Pivot

▼ OEM Reference

HY 2039119	HY 2046263	YT 585096306
HY 2040200	YT 524140839	



Part Number - 370282

Roll Pin

▼ OEM Reference
 HY 2305246
 HY 2305923
 YT 502677902



Part Number - 370168

Pin-Coiled Roll

▼ OEM Reference
 CL 2039122
 HY 2039122
 YT 524140842



Part Number - 370049
Push Rod Pin

▼ OEM Reference

BK 992655	HY 3008398	TY 00591-76721-81
CL 7001861	TY 00591-37129-81	YT 641786100
HY 2306563	TY 00591-58542-81	YT 641786101



Part Number - 370568
Pin

▼ OEM Reference

RA 1055342/001
TY 00590-47157-71



Part Number - 370032
Bellcrank Pin

▼ OEM Reference

HY 2309006
TY 00591-74640-81
YT 518360601



Part Number - 370021
Pin

▼ OEM Reference

HY 2304484
YT 502303101



Part Number - 370523
Pin - Eccentric

▼ OEM Reference

CL 7002726	MB 219752	TY 00591-58821-81
CT 1009581	RA 850-135-024	TY 00591-75084-81
CT 219752	RA DS226980	YT 220021919
HY 3125492	TY 00590-01006-71	
MB 1009581	TY 00591-38654-81	



Part Number - 370047
Pin

▼ OEM Reference

HY 2305824
TY 00591-76719-81
YT 640697303



Part Number - 370112
Pin

▼ OEM Reference

LI 149463



Part Number - 370134
Threaded Pin

▼ OEM Reference

BT 301779-000
KO 301779-000
PM 301779-000
RA 301779-000



Part Number - 370117
Pin

▼ OEM Reference

LI 149444



Part Number - 370118
Pin

▼ OEM Reference

LI 149448



Part Number - 370018
Link Pin

▼ OEM Reference

BK 992658	HY 3005847	TY 00591-57741-81
CL 7001855	HY 3006808	TY 00591-76456-81
HY 2307202	TY 00591-37127-81	YT 64857200



Part Number - 370023
Pin

▼ OEM Reference

HY 2033718
HY 2311661
TY 00591-76553-81
YT 503688200



Part Number - 370124
Pin Weldment

▼ OEM Reference

CT 1037037
HY 3134462
RA 114-007-795
RA DS236851
YT 220027831



Part Number - 370165
Pin

▼ OEM Reference

HY 2039118
YT 524140838



Part Number - 370088
Pin

▼ OEM Reference

CL 7002719	TY 00591-76606-81	YT 507244500
TY 00591-31352-81	YT 505654500	YT 220037532
TY 00591-58507-81	YT 505654600	



Part Number - 370542

Pin

▼ OEM Reference

CL 447403 RA 116-000-340 YT 220007898
 HY 3026642 TY 00591-75904-81



Part Number - 370279

Pin

▼ OEM Reference

BT 312650-000 RA 939-353-050
 PM 312650-000 TY 00590-43547-71
 RA 312650-000



Part Number - 370135

Pin

▼ OEM Reference

BT 47930 JU 47930 PM 47930
 BT 600114 KO 47930 RA 47930
 BT 650595 LR 20274P



Part Number - 370570

Pin

▼ OEM Reference

BT 313067-000
 PM 313067-000
 RA 313067-000



Part Number - 370131

Pin

▼ OEM Reference

BT 47931 LR 20275 TY 00591-43274-81
 JU 47931 PM 47931
 KO 47931 RA 47931



Part Number - 370294

Pin

▼ OEM Reference

HY 2033691
 YT 502677909

PS1000 Tire

Excellent Stability and Comfort

Unique concave sidewall shape

Exceptional Service Life

Extra deep wearable tread

Outstanding Wear Resistance

Extra wide contact area

Very Low Heat Build-Up

Innovative cushion compound



The orange stripe appears approximately 100 hours before the tires need to be replaced.



See the Wheels and Tires Section



WorkAssist®

Organized Space Can Increase Productivity

Solutions designed to make an operator's job faster and easier.

Storage Bin Kit



Clip Pad



Storage Pocket



Shrink Wrap Holder



Cup Holder



See Section 6 For Work Assist





Part Number - 370573
Pin (Standard)
 ▼ OEM Reference
 RA 312651-002
 TY 00590-43358-71



Part Number - 370559
Pin
 ▼ OEM Reference
 CL 7002030 MB 1055807 TY 00590-48808-71
 CT 1055807 RA 623-003-060 TY 00591-37371-81
 HY 3014431 RA DS232306 YT 220003792



Part Number - 370184
Pin
 ▼ OEM Reference
 BR PM301996002 HY 3137894 KO OP03000786
 BR PM301996-002 HY 3137894SYS PM 301996-002
 BT 301996-002 KO 301996-002 RA 301996-002
 CL 921509 KO 8730181 YT 220029894



Part Number - 370186
Pin
 ▼ OEM Reference
 PM 301996-000



Part Number - 370188
Pin
 ▼ OEM Reference
 CL 7002788 TY 00591-38810-81 YT 506634500
 HY 2033820 TY 00591-58525-81 YT 507327500
 HY 2305449 TY 00591-76629-81
 HY 3057533 YT 220037533



Part Number - 360038-280
Pin (Begin S/N B827N37823G)
 ▼ OEM Reference
 HY 302380
 YT 580063963



Part Number - 370532
Pin
 ▼ OEM Reference
 HY 3126360 RA DS224777
 RA 850-137-581 YT 220021122



Part Number - 370301
Pin
 ▼ OEM Reference
 CT A0000-16446
 HY 231062
 HY 3018575
 LP 757-4040
 MB A0000-16446
 MB A000016446
 YT 501195100
 YT 501195500



Part Number - 360038-273
Pin
 ▼ OEM Reference
 AC 308439-000
 BT 308439-000
 KO 308439-000
 PM 308439-000
 RA 308439-000



Part Number - 370524
Pin
 ▼ OEM Reference
 RA 851-200-566



Part Number - 370094
End Cap
 ▼ OEM Reference
 BK A5A BK 985194 TY 00591-70790-81
 BK PAL18A CL 7001798 YT 220017020
 BK PAL18AK SC 21-41501
 BK 153451 TY 00591-30791-81



Part Number - 370510
Bushing - Spherical
 ▼ OEM Reference
 BK 6607190001 HY 205921 YT 220075015
 BK L6607190001 JU 14458060 YT 580052264
 CT 216108 LI 6607190001 YT 5910609081
 HY 1350680 MB 216108
 HY 1568039 RA 460-105



Part Number - 370114
Bushing

▼ OEM Reference
BK 153083
LI 153083



Part Number - 370166
Bushing

▼ OEM Reference
HY HY2039226
YT YT524140880



Part Number - 370115
Bushing

▼ OEM Reference
BK 153082
LI 153082



Part Number - 370225
Bushing

▼ OEM Reference
JU 26904730



Part Number - 370089
Bushing

▼ OEM Reference
HY 2033629 YT 504248505
HY 2034088 YT 507248505
HY 2038070 YT 585086303
TY 00591-74609-81

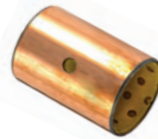

Part Number - 370251
Bushing

▼ OEM Reference
JU 51173971



Part Number - 370526
Bushing - Sleeve

▼ OEM Reference
RA 1025348-007



Part Number - 370549
Bushing

▼ OEM Reference
AC 8735796 BT 307741-000 PM 11695-12
AC 8736462 KO 8735796 PM 307741-000
AC OP03001395 KO 8736462 RA 851-200-257
BT 11695-12 KO OP03001395



Part Number - 370551
Bushing - Sleeve

▼ OEM Reference
CT NA012817 RA 7-460-004/002
MB NA012817 RA DS225820



Part Number - 065007-102
Bushing

▼ OEM Reference
AC 1902-55019 HY 2792008 MB 27807160
AC 3BA-25-25270 HY 2792092 MB 50012676
AC 4930406 HY 2793267 MB 50019663
AE 109983 HY 3025470 MB 560502020
BK 0009230231 HY 3123928 MB 77800733
BK L0009230231 HY 800012333 MB W205010319
BK L0199990340 HY 800075575 MT 23163
BR AT109983 HY 800086751 MT 77800733
CL 2754471 JU 26915362 NI AL109983
CL 70014440 JU 27807160 TY 00591-02391-81
CT 27807160 JU 50012676 TY 00591-36099-81
CT 50012676 JU 50019663 TY 00591-60582-81
CT 50019663 KO 3BA-25-25270 TY 00591-75329-81
CT 560502020 KO 4930406 YN SA430134
CT 77800733 KO 4967811 YT 220005064
CT W205010319 LI 0009230231 YT 220035999
DW A376514 LI L0009230231 YT 272019100
HP MU23163 LI L0199990340 YT 273130200



Part Number - 370293
Bushing

▼ OEM Reference
HY 2042864
YT 314011168



Part Number - 370132
Bushing

▼ OEM Reference
BT 176827 PM 176827
HY 2027716 RA 176827
LR 20306 YT 912630302



Part Number - 370169
Bushing

▼ OEM Reference
HY 2039224
YT 524140878



Part Number - 370254

Bushing

▼ OEM Reference

CL 7003600	MB 1063128	TY 00591-40800-81
CT 1063128	RA DS232947	YT 220002046
HY 3015671	RA 623-005-041	



Part Number - 370142

Bushing/String Guard

▼ OEM Reference

YT 524148752
HY 2046056



Part Number - 370126

Entry Roller

▼ OEM Reference

BT 47150	KO 47150	PM 47150
JU 47150	LR 10281	RA 47150
	MG 545	TY 00591-43241-81

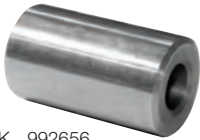

Part Number - 370017

Exit Roller

▼ OEM Reference

BK 992656	HY 3006938	TY 00591-54001-81
HY 2307475	TY 00591-11035-81	YT 64857600
HY 3003759	TY 00591-30854-81	YT 751791300



Part Number - 370173

Roller Assembly

▼ OEM Reference

HY 2039905
YT 524141181

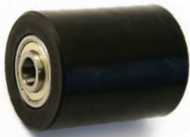

Part Number - 370127

Load Wheel Assembly - Nylon

▼ OEM Reference

BG 906-0023-N-A	BT 56771	RA 126729
BT 126729	LR 20210N	RA 167600
BT 167600	PM 126729	
BT 167609-SUPER	PM 167600	



Part Number - 310244-302-88

Load Wheel Assembly

▼ OEM Reference

CT 51064639
JU 51064639
MB 51064639



Part Number - 370231

Load Wheel Assembly

▼ OEM Reference

CT 50136157	JU 50136157	MB 50136157
CT 50179921	JU 7180668	MB 50179921
CT 71305290	JU 71305290	MB 71305290
CT W2050-11106	JU 71806680	MB W2050-11106



Part Number - 370198

Load Wheel Assembly

▼ OEM Reference

CT 50265511
MB 50265511
MT 090153008
NI MT090153008



Part Number - 370737

Load Wheel Assembly

▼ OEM Reference

HY 4081639	HY 4121767	YT 582032964
HY 4081688	YT 582032962	YT 582032968
HY 4081700	YT 582032966	



Part Number - 310478-302-88

Wheel Kit Assembly

▼ OEM Reference

RA 632-069/ASM



Part Number - 370317

Wheel

▼ OEM Reference

YT 754960401



Part Number - 310225-302

Load Wheel

▼ OEM Reference

RA 1002754-007
TY 00590-41747-71



Part Number - 380500-051

Load Wheel Assembly

▼ OEM Reference

BT 240308
PM 240308
RA 240308



Part Number - 370296

Caster Wheel Assembly

▼ OEM Reference
 HY 1600351
 HY 1600352
 YT 580062912
 YT 580062913



Part Number - 310261-102-YT

Caster - Spring Load

▼ OEM Reference
 CT A000021149 MB A000021149
 CT A0000-21149 MB A0000-21149
 HY 2044852 YT 580023164

▲ **WARNING:** Cancer - www.P65Warnings.ca.gov



Part Number - 370020

Link

▼ OEM Reference

CL 7002613 HY 2307680 TY 00591-58622-81
 HY 2033719 TY 00591-38396-81 YT 500989200



Part Number - 370091

Threaded Rod

▼ OEM Reference
 CL 2039315
 HY 2039315
 YT S00736690075
 YT 524141079



Part Number - 370514

Caster Bolt

▼ OEM Reference

CL 445666 MT 4207034118 TY 00591-63157-81
 CL 7001874 RA 812-001-266 YT 220002706
 HY 3007318 TY 00591-07616-81
 JU 50208484 TY 00591-30869-81



Part Number - 370129

Control

▼ OEM Reference

CT A000010382 NI CK924663 RA 301718-000
 KO 301718-000 PM 301718-000 YT 220043370



Part Number - 370121

Grease Fitting Flush

▼ OEM Reference

BK 001640	HY 3014862	RA 841-111
BR 9872-008	HY 3055565	RA DS227104
BR A9872-8	HY 3064274	TY 00590-00423-71
BR CK624280	HY 3143332	TY 00591-00599-81
BT 310546-000	LI 001640	TY 00591-36910-81
BT 310549-000	MB 1009498	TY 00591-54032-81
CA 624280	MB 217554	TY 00591-54033-81
CL 624280	MB GS00-01766	YT 220003882
CL 1313115	NI CK1313115	YT 220016081
CT 1009498	NI CK624280	YT 220043332
CT 217554	PM 310546-000	YT 220072237
CT GS00-01766	PM 310549-000	YT 507167800
HY 2302457	RA 310546-000	YT 524250487
HY 3012701	RA 310549-000	



Part Number - 370227

Grease Fitting

▼ OEM Reference
 JU 50007986



Part Number - 370120

Grease Fitting Threaded

▼ OEM Reference

CL 1808279	RA 20026	TY 00590-43227-71
HY 2042833	RA 939-352-043	YT 15628700
JU 50013308	TY 00590-00019-21	



Part Number - 370304

Grease Fitting

▼ OEM Reference

AC 11160-09	PM 11160-09
BT 11160-09	RA 11160-09
KO 11160-09	TC 11160-09



Part Number - 370292

Grease Fitting

▼ OEM Reference
 HY 2007882
 YT 015631500



Part Number - 370460

Grease Fitting

▼ OEM Reference
 BR 48674-FS000
 NI 48674-FS000
 TY 00591-63053-81



Part Number - 370159

Grease Fitting

▼ OEM Reference
 RA 840-018



Part Number - 370179

Oil Seal

▼ OEM Reference

CL 102361	HY 3006347	SL S20098
CL 1124E2	HY 3125222	TY 00590-00415-71
CL 117604	MB A0000-00050	TY 00591-07603-81
CT A0000-00050	MB A000000050	TY 00591-32057-81
CT 1009119	MB 1009119	TY 00591-50668-81
CT 3J4776	MB 2I7577	YT 220001910
HY 0018773	RA DS224928	YT 220002307
HY 0029058	RA DS226562	YT 220017349
HY 18773	RA 530-638	YT 220020222
HY 29058	RA 530-688	



Part Number - 370164

Spring

▼ OEM Reference

HY 1531075
YT 580038175



Part Number - 370170

Screw

▼ OEM Reference

HY 2791024	HY 296203	YT 277274300
HY 2798772	YT 273075800	YT 580013990

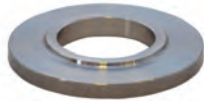

Part Number - 370139

Shield Bearing

▼ OEM Reference

CL 7002777	HY 3142320	TY 00591-76552-81
CT A000032617	TY 00591-38769-81	YT 503480200
HY 2042262	TY 00591-58661-81	



Part Number - 370172

Washer

▼ OEM Reference

BR 9878-024	LP 1069-1210	YT 2720064007
HY 2035534	YT 062960000	



Part Number - 370207

Seal Kit

▼ OEM Reference

CL 7003597	RA 530-712-01	RA DS228499
CT 1008994	RA 530-725-01	TY 00591-31900-81
CT 1056005	RA 531-103	TY 00591-70194-81
HY 3006383	RA 531-209	YT 220001916
MB 1008994	RA 623-005-122	

⚠ WARNING: Cancer - www.P65Warnings.ca.gov



Part Number - 370263

Washer

▼ OEM Reference

HY 2307951
YT 065055200



Part Number - 370209

Seal Kit

▼ OEM Reference

CT 50033984
JU 50033984
MB 50033984
RA 530-749-001



Part Number - 370205

Oil Seal

▼ OEM Reference

CL 562783	CT 973721	RA 530-641
CL 952179	KO 4995652	YT 091654100
CT 0973721	RA 530-517	YT 220004243
CT 1036493	RA 530-617	YT 220050212



Part Number - 360038-265

Washer

▼ OEM Reference

AC 301776-000
BT 301776-000
KO 301776-000
PM 301776-000
RA 301776-000



Part Number - 360038-270

Cap Screw

▼ OEM Reference
 HY 2043856
 YT 524144586



Part Number - 370175

Flanged Bearing

▼ OEM Reference
 HY 2100235
 YT 524302804



Part Number - 370194

Plate Carrier

▼ OEM Reference

CL 7002175	RA 623-010-154	TY 00591-70849-81
CT 1055823	RA 828-008-204	YT 220017203
CT NA012934C	RA DS237267	
HY 3039852	TY 00591-31076-81	



Part Number - 370267

Plate Carrier

▼ OEM Reference
 RA 623-010-109



Part Number - 370162

Spacer

▼ OEM Reference

CL 7001735	TY 00591-30752-81	YT 121357100
HY 2037487	TY 00591-60741-81	YT 220035779
HY 3007123	TY 00591-76463-81	



Part Number - 370266

Spacer

▼ OEM Reference
 RA 1031101



Part Number - 370180

Tube Spacer

▼ OEM Reference
 RA 1045247-001



Part Number - 370210

Swivel Assembly

▼ OEM Reference

CL 7001918	RA 870-410-17	RA 870-410-26
HY 3018295	RA 870-410-20	RA 870-410-27
PM 200903	RA 870-410-22	TY 00591-30924-81
PM QJ-112207	RA 870-410-23	TY 00591-63170-81
PM QJB-002881	RA 870-410-24	YT 220002254
RA 787-047-100	RA 870-410-25	



Part Number - 060009-037

Retaining Ring

▼ OEM Reference
 RA 810-131

▲ **WARNING:** Cancer and reproductive harm - www.P65Warnings.ca.gov



Part Number - 380700-015

Shaft

▼ OEM Reference

BT 623-003-040	HY 3016454	RA 623-003-040
BT 623-003-041	HY 3126892	RA 623-003-041
BT 828-005-287	MB 1055875	RA 828-005-287
BT 828-006-676	MB A0000-31451	RA 828-006-676
BT DS232229	PM 623-003-040	RA DS232229
CL 7001990	PM 623-003-041	TY 00590-48784-71
CT 1055875	PM 828-005-287	TY 00591-30966-81
CT A0000-31451	PM 828-006-676	YT 220017887
GM 0712-99XF	PM DS232229	YT 220034271



Part Number - 380700-016

Shaft

▼ OEM Reference

BT 828-005-286	PM 828-005-286	RA 828-006-678
BT 828-006-678	PM 828-006-678	RA DS232228
BT DS232228	PM DS232228	YT 220034270
HY 3126890	RA 828-005-286	



Part Number	Description	OEM Reference	
361038-279	Back-Up Alarm		
370259	Battery Charger - AMG & Flooded Batteries - S.N. B827N55791L & later		
370252	Battery Charger - Micro Control		
370005	Battery Discharge Indicator	HY 2046546	YT 580026708
310261-102-YT	Caster Assembly	HY 2044852	YT 580023164
310282-306	Caster Wheel	HY 2046537	YT 524149213
370660	Contactora - S.N. B827		
3C0016-R	Controller	HY 2045951-R	YT 585098300-R
340077-005	Fuse 5 amp		
802816-009	Fuse 150 amp	HY 354589	YT 504450730
340047-175	Fuse 175 amp		
102126-002	Ground Strap		
370061	Hub	HY 2049428	YT 501087300
370054	Ignition Switch	HY 3005833	YT 500863104
370087	Key - 1 piece	HY 262798	YT 500863106
370041	Pump Motor - S.N. B827	HY 1466025	YT 580012669
084343	Solenoid	HY 1198392	

▲WARNING: Cancer - www.P65Warnings.ca.gov

Handle Assembly - Control Arm



1 - Steer Arm Tiller Assembly
P.N. 370011

▼ OEM Reference
HY 2050082
YT 524143951

4 - Steer Arm Pin
P.N. 370006

▼ OEM Reference
HY 2059695
YT 272027800

2 - Gas Spring
P.N. 370008

▼ OEM Reference
HY 2050083
YT 524149338

5 - Washer
P.N. 370012

▼ OEM Reference
HY 2791931
YT 272006400

3 - Pin
P.N. 370060

▼ OEM Reference
HY 302375
YT 580031999

7 - Bumper (2 Required)
P.N. 360038-271

▼ OEM Reference
HY 2050084
YT 524149326

13 - Cap Screw
P.N. 360038-270

▼ OEM Reference
HY 2043856
YT 524144586

14 - Handle Wiring Harness
P.N. 370015

▼ OEM Reference
HY 2066432
YT 580046976

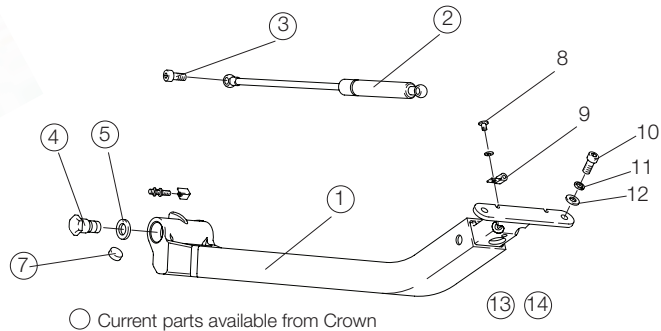

○ Current parts available from Crown

Control Handle Assembly

1 & 2 - Control Handle Upper/Lower Set
P.N. 370259

4 - Switch Assembly
P.N. 370058

▼ OEM Reference
HY 1466877
YT 524148521

5 - Switch
P.N. 370289

▼ OEM Reference
HY 1498102
YT 580026824

7 - Switch Cover
P.N. 370163

▼ OEM Reference
HY 1467779
YT 580011991

9 - Spring
P.N. 370628

▼ OEM Reference
HY 1466606
YT 580012969

15 - Spring
P.N. 370077

▼ OEM Reference
HY 1466607
YT 580012970

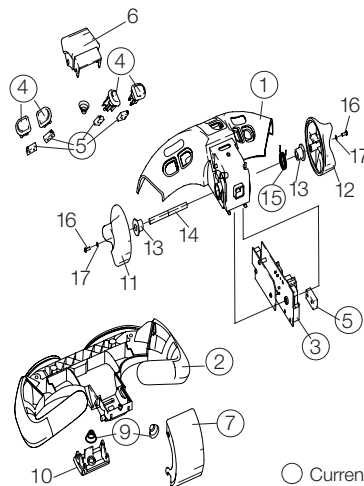

○ Current parts available from Crown

Drive Unit and Brake Assembly

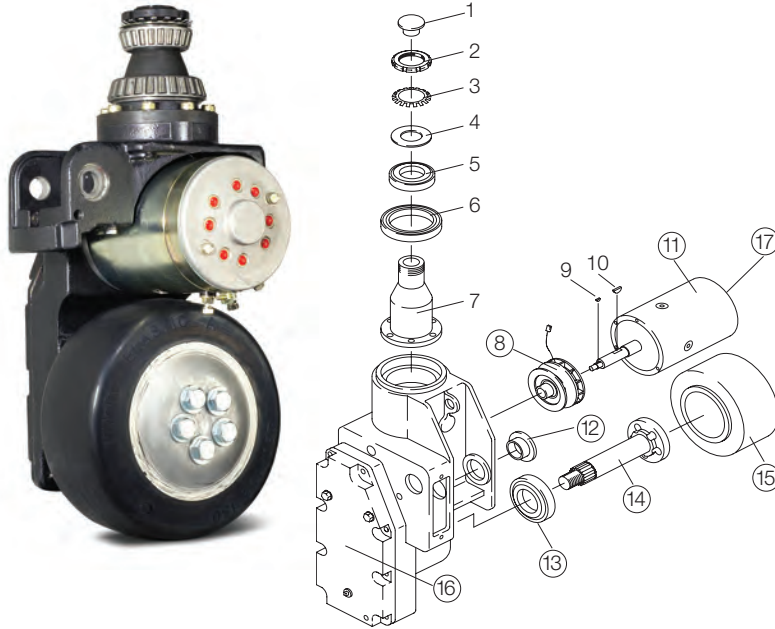

○ Current parts available from Crown

8 - Brake Assembly

P.N. 370038

▼ OEM Reference
HY 2046003
YT 524148583

11 - Drive Motor

P.N. 370043

▼ OEM Reference
HY 2049316
YT 580031000

12 - Bushing

P.N. 370019

▼ OEM Reference
HY 2791987
YT 272015100

13 - Bearing Cup

P.N. 065105

▼ OEM Reference
HY 163971
YT 055076400

14 - Drive Axle

P.N. 370031

▼ OEM Reference
HY 2304321
YT 506566500

15 - Poly Tire

P.N. 077848-xxx-xx

▼ OEM Reference
HY 2045112
YT 524142925

15 - Rubber Tire

P.N. 076751-xxx

▼ OEM Reference
HY 2045107
YT 524142926

16 - Motor Cover (RH as viewed from operator)

P.N. 370034

▼ OEM Reference
HY 1495763
YT 524144502

16 - Motor Cover (LH as viewed from operator)

P.N. 370035

▼ OEM Reference
HY 1495764
YT 524144503

17 - Drive Motor Brush Set & Springs

P.N. 370042

▼ OEM Reference
HY 1506791
YT 580029149

Hyster W40 XL / W40 XT

Drive Unit and Brake Assembly

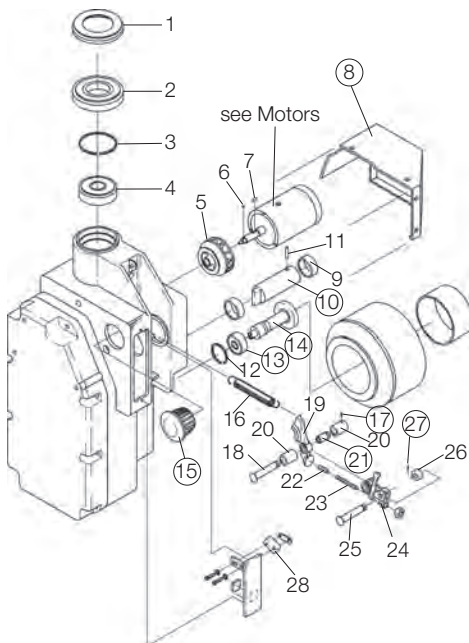

○ Current parts available from Crown

8 - Drive Motor Cover

P.N. 370024

▼ OEM Reference
HY 2041689

10 - Shaft

P.N. 370030

▼ OEM Reference
HY 2305815

13 - Bearing Cup

P.N. 065105

▼ OEM Reference
HY 163971

13 - Bearing Cone

P.N. 065106

▼ OEM Reference
HY 174230

14 - Drive Axle

P.N. 370031

▼ OEM Reference
HY 2304321

15 - Plug

P.N. 370055

▼ OEM Reference
HY 2307952

17 - Cotter Pin

P.N. 060038-013

▼ OEM Reference
HY 2302589

21 - Bushing

P.N. 370052

▼ OEM Reference
HY 2302396

27 - Cotter Pin

P.N. 060038-002

▼ OEM Reference
HY 15200

IMAGE NOT AVAILABLE

Part Number - 3D828-006-355-R

Drive Unit RA R-Drive-Gear Reducer

▼ OEM Reference
RA 828-006-355



Part Number - 370259

Control Handle Upper/Lower Set

Offering the complete handle instead of separate upper and lower pieces.

▼ OEM Reference

HY 1467778	HY 4005445	YT 550005599
HY 2045501	YT 524139006	YT 580011989

IMAGE NOT AVAILABLE

Part Number - 3D828-005-677-R

Drive Unit EASI OPR RA R-Drive Unit

▼ OEM Reference
RA 828-005-677



Part Number - 370264

Handle Assembly

▼ OEM Reference
YT 550013954

Part Number - 370011

Steer Arm

▼ OEM Reference
HY 2050082
YT 524143951



Part Number - 370548

Rabbit Button - Left

▼ OEM Reference
CT 1041752
MB 1041752
RA 850-138-146



Part Number - 370025

Steer Arm Weldment

▼ OEM Reference
HY 2308794
YT 503771700



Part Number - 370564

Button - Right Rabbit

▼ OEM Reference
RA 850-138-145
TY 00590-47338-71



Part Number - 370299

Tiller Handle Weldment

▼ OEM Reference
YT 582003278



Part Number - 370552

Handle Kit - With Hole

▼ OEM Reference

BK 709802	MB 215835	TY 00591-35105-81
CL 7000891	RA 154-002-535	TY 00591-35106-81
CL 7001859	RA 360-019	TY 00591-63096-81
CT 215835	RA 360-919	TY 00591-63097-81
HY 3007931	SC 25-40466	YT 220027886
HY 3136092	SC 33-01855	
LI 709802	TY 00591-30856-81	

Part Number - 370318

Handle Stem Weld (Mach)

▼ OEM Reference
AC OP03001390 KO 8733377
BT 301766-000 KO OP03001390
KO 8730369 PM 301766-000 RA 301766-000



Part Number - 351096-345

Tiller Handle

▼ OEM Reference
RA 1066425-001



Part Number - 370563

Actuator - Cam Assembly (Clear)

▼ OEM Reference

CT NA013594	RA 850-135-945	RA DS226464
HY 3127435	RA 850-138-049	YT 220022103
MB NA013594	RA 850-138-076	



Part Number - 370312

Yoke

▼ OEM Reference
RA 301721-000

Part Number - 360038-269

Handle Grip

▼ OEM Reference
HY 2311072
YT 519305803
YT 620086100





Part Number - 398000-087
Handle Grip
 ▼ OEM Reference

HY	800041750	RA	850-135-971/001
RA	1018936-001	TY	00590-47247-71
RA	1027267-001	YT	800041750
RA	850-135-971-001		



Part Number - 370740
Premium Tiller Wire Harness
 ▼ OEM Reference

HY	4634734
YT	582038475



Part Number - 370571
Grip
 ▼ OEM Reference

RA	301720-000
----	------------



Part Number - 370015
Handle Wiring Harness
 ▼ OEM Reference

HY	2066432
YT	580046976



Part Number - 370520
Handle Bearing
 ▼ OEM Reference

CT	NA013590	MB	NA013590	RA	DS226465
HY	3126421	RA	850-135-959	YT	220020786



Part Number - 370285
Harness
 ▼ OEM Reference

RA	10314271-001
----	--------------



Part Number - 380700-017
Pivot Pin - Handle
 ▼ OEM Reference

BT	850-135-970	PM	850-135-970	RA	850-138-996
BT	850-138-996	PM	850-138-996	RA	DS226076
BT	DS226076	PM	DS226076	YT	220020943
HY	3126312	RA	850-135-970		



Part Number - 370281
Head Harness
 ▼ OEM Reference

BT	313436-00	PM	313436-000	TY	00590-43482-71
PM	313436-00	RA	313436-00	TY	939-353-134
		RA	939-353-134		



Part Number - 380500-933
Spring
 ▼ OEM Reference

BT	167836	RA	167836
PM	167836	TY	00590-42420-71

Note: Used with P.N. 370195



Part Number - 370325
Harness, Handle Stem
 ▼ OEM Reference

AC	OP03001434	KO	8734720	PM	307193-000
BR	PM305881-000	KO	8735479	RA	305881-000
BT	305881-000	KO	OP03001434	RA	307193-000
		PM	305881-000		



Part Number - 370738
Handle Return Spring
 ▼ OEM Reference

TY	00590-43300-71
----	----------------



Part Number - 370562
Travel Harness
 ▼ OEM Reference

BT	850-136-859	PM	850-136-859	RA	850-136-859
BT	850-136-927	PM	850-136-927	RA	850-136-927



Part Number - 370007
Handle Switch
 ▼ OEM Reference

HY	2049350
YT	524153715



Part Number - 370289

Switch

▼ OEM Reference
HY 1498102
YT 580026824



Part Number - 370288

Button

▼ OEM Reference
YT 524149804



Part Number - 370439

**Switch Assembly
Comp Lower Micro**

▼ OEM Reference
BR 48411-FS004 NI 48411-FS004
BR 48487-FS001 NI 48487-FS001



Part Number - 370773

**Button - Handle
Creep Speed Switch**

▼ OEM Reference
YT 582007134



Part Number - 370058

Switch Assembly - 2 Wire

▼ OEM Reference
HY 1466877
YT 524148521



Part Number - 398000-094

Button - Lift/Lower

▼ OEM Reference
BT 1041754 RA 850-138-654 YT 800131363
HY 800129472 RA 1041754
PM 1041754 TY 00590-47341-71



Part Number - 380700-026

Switch Assembly

▼ OEM Reference
BT 850-138-298-001 CT NA17440 PM 850-138-298-001
BT 850-139-149-001 MB NA013127 PM 850-139-149-001
CT NA013127 MB NA017440 RA 850-138-298-001
CT NA017440 MB NA13127 RA 850-139-149-001
CT NA13127 MB NA17440 TY 00590-02108-71



Part Number - 360038-278

Button Nose Assembly

▼ OEM Reference
RA 850-135-976-001



Part Number - 380700-025

**Grab Bar Switch
Assembly**

▼ OEM Reference
PM 1066671-001
RA 1066671-001



Part Number - 370195

Button Reverser

▼ OEM Reference
TY 00590-47054-71
Note: Replacement spring:
P.N. 380500-933



Part Number - 370749

Horn Contact Set

▼ OEM Reference
HY 1374067 YT 518794640
HY 1391205 YT 580000284



Part Number - 370332

Button Reverser

▼ OEM Reference
RA 1036419/001



Part Number - 370458

Belly, SW, CVR

▼ OEM Reference
BR 48495-FS000
NI 48495-FS000



Part Number - 370163

Cover Switch

▼ OEM Reference
HY 1467779
YT 580011991



Part Number - 370761

Horn Cover

▼ OEM Reference
 HY 1489471
 YT 524139009
 YT T582003460



Part Number - 370736

Bumper, Control Handle

▼ OEM Reference
 HY 2302746
 YT 504732200



Part Number - 370315

Lower Cover

▼ OEM Reference
 RA 313060-001



Part Number - 370220

Drive Tire

▼ OEM Reference
 JU 50460101



Part Number - 351096-243

Potentiometer

▼ OEM Reference
 RA 851-200-951



Part Number - 380700-023

Encoder

▼ OEM Reference
 BT 1-185-006/001 MB A0000-13359 RA 1-185-006/001
 BT 1-185-006/006 PM 1-185-006/001 RA 1-185-006/006
 CT A0000-13359 PM 1-185-006/006



Part Number - 370517

Potentiometer

▼ OEM Reference
 CL 7003758 RA 1007256/004 TY 00591-32042-81
 HY 3026968 RA 1-007-256-004 TY 00591-63080-81
 RA 1007256004 RA 1-120-112-004 YT 220007740



Part Number - 370550

Sensor Proximity

▼ OEM Reference
 RA 1022003/001



Part Number - 380700-002

Potentiometer

▼ OEM Reference
 BT 1-120-098 MB 1009543 RA 1-120-105
 BT 1-120-105 MB NA014027 RA 1120105
 BT 1120105 MB NA014028 RA DS224314
 BT DS224314 PM 1-120-098 TY 00590-04513-71
 CL 448169 PM 1-120-105 TY 00590-42169-71
 CT 1009543 PM 1120105 YT 220018415
 CT NA014027 PM DS224314
 CT NA014028 RA 1-120-098



Part Number - 370555

Encoder Bearing

▼ OEM Reference
 RA 1012203



Part Number - 370742

Potentiometer, Accelerator (Pedal Position Sensor)

▼ OEM Reference
 CT A0000-16080 MB A0000-16080
 HY 1354990 YT 505966574



Part Number - 370006

Handle Pin

▼ OEM Reference
 HY 2059695 HY 2793129 YT 524179191
 HY 2062561 YT 272027800 YT 524179191A
 HY 2792053 YT 272311800 YT 524190001



Part Number - 351096-322

Potentiometer

▼ OEM Reference
 RA 1053639



Part Number - 370012

Handle Pin Washer

▼ OEM Reference
 HY 2791931
 YT 272006400



Part Number - 370031

Drive Axle

▼ OEM Reference

HY 2303658	HY 2311203	YT 640846831
HY 2304321	YT 501785300	YT 640846878
HY 2304729	YT 506566500	



Part Number - 370019

Bushing

▼ OEM Reference

BK L0039169600	HY 2799263	YT 272015100
CL 925414	LI L10039169600	YT 277323300
HY 2791987		



Part Number - 370280

Drive Axle

▼ OEM Reference

HY 2308632
YT 508149300
YT 720148300



Part Number - 370557

Spring Arm

▼ OEM Reference

BT 313665-086	RA 114-008-660
PM 313665-086	RA 313665-086

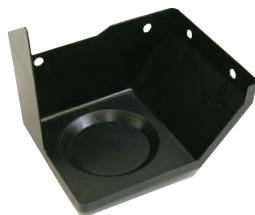

Part Number - 370024

Drive Motor Cover

▼ OEM Reference

HY 2041689
HY 2306863
YT 503753700
YT 580017142

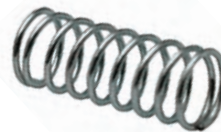

Part Number - 380700-022

Compression Spring

▼ OEM Reference

AC 8126-90020	KO 8126-90020	RA DS226290
BT 830-204	MB 1075082	TY 00590-00139-71
BT 921-000-581	PM 830-204	TY 00591-21100-81
BT DS226290	PM 921-000-581	YT 220019667
CT 1075082	PM DS226290	YT 220043155
HY 3124295	RA 830-204	
HY 3143155	RA 921-000-581	



Part Number - 370030

Shaft

▼ OEM Reference

HY 2305815
YT 505984500



Part Number - 370077

Spring

▼ OEM Reference

HY 1466607
YT 580012970



Part Number - 370535

Steer Shaft

▼ OEM Reference

BT 828-013-690/001	RA 828-005-711-001
RA 828-003-921-001	RA 828-013-690-001



Part Number - 370319

Housing

▼ OEM Reference

BT 167822
PM 167822
RA 167822



Part Number - 370628

Spring

▼ OEM Reference

HY 1466606
YT 580012969



Part Number - 370052

Bushing

▼ OEM Reference

HY 2302396
TY 00591-76732-81
YT 723673100



Part Number - 370527

Spring

▼ OEM Reference

BT 312268-000	CT NA021466	PM 312268-000
BT 830-243	MB NA015902	RA 830-243
CT NA015902	MB NA021466	RA 830-426



Part Number - 370053

Pivot Pin

▼ OEM Reference
HY 2302412
YT 723683100



Part Number - 370060

Pin

▼ OEM Reference
HY 302375
YT 580031999



Part Number - 370055

Plug

▼ OEM Reference
HY 2307952
YT 501864902



Part Number - 370008

Gas Spring

▼ OEM Reference
HY 2050083 YT 524149338 YT 580083554
HY 2066312 YT 580046812



Part Number - 370003

Gas Spring

▼ OEM Reference
HY 2040528 YT 524141471 YT 580046627
HY 2047141 YT 524149833 YT 580046811
HY 2066311 YT 524182270



Part Number - 351096-287

Gas Spring Kit

▼ OEM Reference
CT NA022586 RA 543-005 TY 00591-76108-81
RA 1034932-K02 RA 838-010-967/001
RA 543-000-001 RA 838-900-019



Part Number - 370348

Gas Spring

▼ OEM Reference
HY 4602528
YT 582002563



Part Number - 370764

Gas Spring

▼ OEM Reference
HY 4062322
HY 4047416
YT 582031382



Part Number - 370763

Gas Spring

▼ OEM Reference
HY 4602216
YT 582002075



Part Number - 370767

Gas Spring

▼ OEM Reference
HY 2066309 HY 4009088
HY 2063916 YT 582003113



Part Number - 370191

Spring Handle Return

▼ OEM Reference
KO 301765-000
KO 8730367
KO OP03001388
PM 301765-000
RA 851-200-415
TY 00591-75880-81
YT 220043000
YT 220043373



Part Number - 370065

Washer - Flat

▼ OEM Reference
CT 1009446 RA DS226870 TY 00590-00015-71
MB 1009446 RA 771-156



Part Number - 370068

Belt Timing Kit

▼ OEM Reference
CT 1051301
RA 828-900-067



Part Number - 370531

Timing Belt

▼ OEM Reference
CT 1201878 MB 1201878-BAN YT 220019256-BAN
CT 1201878-BAN RA 828-005-180 YT 220044568
HY 3144568 RA 828-005-180-BAN YT 220044568-BAN
HY 3144568-BAN RA 828-900-067-A
MB 1201878 RA 828-900-067-A-BAN

Drive Unit, Brake, and Steering



Part Number - 370038
Brake Assembly

▼ OEM Reference
HY 2046003
YT 524148583



Part Number - 370098
Disc - Brake

▼ OEM Reference
CT NA014187 MB NA014187 RA 870-901-115
CT 1050475 RA 870-834-121 TY 00591-76120-81



Part Number - 370518
Brake - Hydraulic

▼ OEM Reference
CT A000031447 RA 870-901-001
MB A000031447 RA 870-930



Part Number - 370097
Plate - Friction

▼ OEM Reference
CT 1050473
RA 870-834-119



Part Number - 380700-028
Hydraulic Brake

▼ OEM Reference
BT 870-923-100
BT 870-925-001
PM 870-923-100
PM 870-925-001
RA 870-923-100
RA 870-925-001

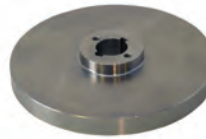

Part Number - 370100
Rotor - Brake

▼ OEM Reference
CT NA052004
MB NA052004
RA 870-856-111



Part Number - 370512
Deadman Pad

▼ OEM Reference
RA 114-022-002



Part Number - 370201
Cylinder Inner

▼ OEM Reference
DS P264-0012 RA 821-900-039-002
RA 820-001-711 RA 870-616
RA 820-002-013 RA 870-747
RA 820-002-173 RA 870-747-100
RA 820-900-019 RA 870-747-200
RA 821-900-039-001 TY 00591-57992-81

▲ WARNING: Cancer - www.P65Warnings.ca.gov



Part Number - 370102
Disc - Brake

▼ OEM Reference
RA 870-920-119



Part Number - 370103
Disc - Brake

▼ OEM Reference
RA 870-923-111



Part Number - 370772
Parking Brake Cable

▼ OEM Reference
CL 448567
TY 46401-12240-71
TY 46401-12241-71



Part Number - 3J97220-05200-R

Pump R-Motor 36/48V

▼ OEM Reference
CT 97220-05200



Part Number - 3J570-287-500-R

Pump R-Motor 36V

▼ OEM Reference
RA 570-287-500



Part Number - 370041

Pump AM Motor 24V

▼ OEM Reference
HY 1466025
YT 580012669



Part Number - 3J570-236-500-R

Pump R-Motor 36V

▼ OEM Reference
RA 570-236-500



Part Number - 3J5045752-33-R

Pump R-Motor 36V

▼ OEM Reference
HY 2305653
YT 5045752-33



Part Number - 3J570-367-500-R

Pump R-Motor 36V

▼ OEM Reference
RA 570-367-500



Part Number - 3J14510U116071-R

Pump R-Motor

▼ OEM Reference
TY 14510-U1160-71



Part Number - 3J570-358-451-R

Pump R-Motor 36V

▼ OEM Reference
OH D-481581X7147A
RA 570-358-450
RA 570-358-451



Part Number - 3J2304547-R

Pump R-Motor 12V

▼ OEM Reference
HY 2304547
HY 2311188



Part Number - 3J570-317-500-R

Pump R-Motor 24V

▼ OEM Reference
RA 570-317-500



Part Number - 3J005904128971-R

Pump R-Motor 24V

▼ OEM Reference
TY 00590-41289-71



Part Number - 3J570-379-451-R

Auxiliary Pump R-Motor 36V

▼ OEM Reference
RA 570-379-451



Part Number - 3J143201224171-R

Pump R-Motor

▼ OEM Reference
TY 14320-12241-71



Part Number - 3J570-299-500-R

Pump R-Motor 24/36V

▼ OEM Reference
RA 570-299
RA 579-299
RA 570-299-500



Part Number - 3J570-273-500-R

Pump R-Motor 36/48V

▼ OEM Reference
RA 570-273-500



Part Number - 3J570-269-500-R

Pump R-Motor 36V

▼ OEM Reference
RA 570-269-500



Part Number - 3J1016481-450-R

Pump R-Motor 36V

▼ OEM Reference
RA 1016481-450 RA C42-1215X6377A
RA 1016481/450R RA C-421215X6377A-R



Part Number - 3J570-412-R

Pump R-Motor 24V

▼ OEM Reference
RA 570-412



Part Number - 3J70-049-00-R

Drive R-Motor 24-36-48 V

▼ OEM Reference
AV ER5-4001 GE 5BC48JB814
AV ER9-4004 GE 5BC58JBS6110A
BJ D387 GE 5BC58JBS6110B
GE 5BC48JB550 GE 5BC48JBS6344
GE 5BC48JB550B TA 70-025-20
GE 5BC48JB582 TA 70-049-00
GE 5BC48JB754B TA 70-049-00-R



Part Number - 370298

Pump & Motor Assembly Hydraulic

▼ OEM Reference
BT 1163002/001
RA 1163002-001



Part Number - 3J70-052-40-R

Drive R-Motor 24-36-48 V

▼ OEM Reference
AV DD3-4004 TA 70-052-40
AV DD3-4004-R TA 70-052-40-R



Part Number - 3J851-200-859-R

Pump R-Motor 24V

▼ OEM Reference
RA 851-200-859



Part Number - 3J570-867-500-R

Drive R-Motor 24V

▼ OEM Reference
RA 570-867-500



Part Number - 3J143201224071-R

Pump R-Motor 36V

▼ OEM Reference
TY 14320-12240-71



Part Number - 3J570-388-500-R

Drive R-Motor 36V

▼ OEM Reference
RA 570-388-500



Part Number - 3J1020545-450-R

Pump R-Motor 36V

▼ OEM Reference
BT 1020545-450
BT 1020545-450-R
DW 1020545-450
DW 1020545-450-R
OH E48-1207X7165A
OH E48-1207X7165-R
PM 1020545-450
PM 1020545-450-R
RA 1020545-450
RA 1020545-450-R



Part Number - 3J570-863-500-R

Drive R-Motor 36V

▼ OEM Reference
RA 570-863-500



Part Number - 3J570-869-701-R

Drive R-Motor 24V

▼ OEM Reference
RA 570-869-701



Part Number - 3J570-368-500-R

Drive/Traction R-Motor 36V Pacer

▼ OEM Reference
RA 570-368-500



Part Number - 3J570-350-500-R

Drive R-Motor 24V

▼ OEM Reference
AD AN6-4003
RA 570-350-500
RA 579-350
RA AN6-4003



Part Number - 3J570-400-500-R

Drive/Traction R-Motor 36V

▼ OEM Reference
RA 570-400-500



Part Number - 3J570-348-500-R

Drive R-Motor 36V EASI

▼ OEM Reference
RA 570-348-500



Part Number - 3J570-415-201-R

Drive R-Motor 24V

▼ OEM Reference
RA 570-415-201



Part Number - 3J570-869-500-R

Drive R-Motor 24V

▼ OEM Reference
RA 570-869-500



Part Number - 3J570-298-500-R

Drive R-Motor 24/36V

▼ OEM Reference
CT 1008792
MB 1008792
RA 570-298-500



Part Number - 3J570-325-500-R

Drive R-Motor 24V

▼ OEM Reference
RA 570-325-500
RA 570-867-500
TY 00590-40563-71



Part Number - 3J570-251-200-R

Drive R-Motor 36V

▼ OEM Reference
RA 570-251/200



Part Number - 3J570-415-500-R

Drive R-Motor 24V

▼ OEM Reference
RA 570-415-500-R



Part Number - 370043

Drive Motor 24V AM

▼ OEM Reference
HY 2049316
YT 580031000



Part Number - 3J570-392-500-R

Drive R-Motor 36V

▼ OEM Reference
RA 570-392-500



Part Number - 3J325744-R

Drive R-Motor 36/48V

▼ OEM Reference
HY 325744
HY 1461192



Part Number - 3J7300310-00-R

Drive R-Motor

▼ OEM Reference
YT 7300310-00



Part Number - 3J70-054-00 (New)

Drive R-Motor 24/36/48V

▼ OEM Reference
GE 5BC49JB305
GE 5BC49JB305B
GE 5BC49JB399C
TA 70-054-00
TA 70-054-03



Part Number - 3J722197020-R

Drive R-Motor 24V

▼ OEM Reference
YT 722197020-R



Part Number - 3J570-363-451-R

Steer R-Motor Reach 36V

▼ OEM Reference
RA 570-363-451



Part Number - 3J2798905-R

Drive R-Motor

▼ OEM Reference
CL 2798905



Part Number - 3J504575231-R

Power Steering R-Motor 24V

▼ OEM Reference
HY 8620016
YT 504575231



Part Number - 3J2819155-R

Drive R-Motor 36V

▼ OEM Reference
CL 2819155



Part Number - 3J580035626-R

Steer R-Motor 36/48V

▼ OEM Reference
HY 8517245
YT 580035626



Part Number - 3J2798867-R

Drive R-Motor 24V

▼ OEM Reference
AD K89-4002
CL 2798867
CL 2780604



Part Number - 3J1457327 (New)

Steer R-Motor 36V

▼ OEM Reference
HY 1457327



Part Number - 3J141102330171-R

Drive R-Motor 36-48V

▼ OEM Reference
TY 14110-23301-71
TY 14110-23302-71



Part Number - 3J29210-41H11 (New)

Steer R-Motor 36V

▼ OEM Reference
NI 29210-41H11



Part Number - 3J5170726-02-R

Steer R-Motor 24V

▼ OEM Reference
YT 517072602



Part Number - 3J2781993-R

Steer R-Motor 36/48V

▼ OEM Reference
CL 2781993
CL 2388112
CL 2809539



Part Number - 370521

Aux/Steer Motor

▼ OEM Reference
BT 1020545-500
PM 1020545-500
RA 1020545-500



Part Number - 370035

Motor Cover (LH as viewed from operator)

▼ OEM Reference
CT A000030530
HY 1495764
HY 1537410
YT 524144503
YT 524184972
YT 550038924



Part Number - 370034

Motor Cover (RH as viewed from operator)

▼ OEM Reference
CT A000030529
HY 1495763
HY 1537409
YT 524144502
YT 524184971
YT 550038923



Part Number - 370133

Brush Kit (Set of 4)

0.488 D x 1.55 W x 1.161 L
▼ OEM Reference
RA 570-869-735
RA 570-869-735-KIT



Part Number - 370136

Brush Kit (Set of 4)

0.503 D x 1.259 W x 1.265 L
▼ OEM Reference
YT 582004077



Part Number - 072059

Brush

▼ OEM Reference

CT 216035	TY 00591-33330-81	YT 220015891
TY 00591-04641-81	TY 00591-60633-81	



Part Number - 084547

Brush

0.370 D x 0.812 W x 1.157 L

▼ OEM Reference

AC 4911481	HY 3052675	TY 00591-32455-81
BK 123603	HY 3144749	TY 00591-51463-81
CL 906300	HY 800063773	TY 00591-72254-81
CL 909819	ME B250407-4	YT 220003593
CT 0973796	ME BMP31-214	YT 220025259
HY 0286081	OH B-250407-4	YT 220044749
HY 3013765	PM 300665-002	YT 220075025



Part Number - 116510

Brush Set (4 of 084547)

0.370 D x 0.812 W x 1.157 L

▼ OEM Reference

CT 973391	TY 00591-32460-81	YT 220016055
OH B-250411-01K	TY 00591-60991-81	YT 518264825



Part Number - 021157-001

Brush

0.62 D x 1.24 W x 1.34 L

▼ OEM Reference

BT 306270-000	KO 302362-000	TY 00591-03840-81
CL 915595	PM 300417-000	TY 00591-33295-81
CL 915933	PM 300430-000	TY 00591-56358-81
CL 915934	PM 301504-000	YT 220014573
HY 3033063	PM 302362-000	YT 220021829
HY 3134050	PM 306270-000	YT 220027150
KO 300430-000	RA 939-194	YT 220044744



Part Number - 370143

**Brush Kit
(4 of 021157-001)**

0.62 D x 1.24 W x 1.34 L

▼ OEM Reference

CT 1008664	MB 1075049	RA DS225074
CT 1008668	MB 1142628	RA DS225081
CT 1009186	RA 570-236-514	RA DS228921
CT 1036510	RA 570-277-515	TY 00590-04567-71
CT 1075049	RA 570-295-514	TY 00590-04575-71
CT 1142628	RA 570-322-122	TY 00591-21088-81
HY 3034522	RA 570-449-513	TY 00591-42660-81
HY 3126436	RA 570-604-512	TY 00591-42677-81
MB 1008664	RA DS223442	YT 220016152
MB 1009186	RA DS224933	YT 220021620



Part Number - 118942

**Brush Set
(8 of 021157-001)**

0.62 D x 1.24 W x 1.34 L

▼ OEM Reference

HY 3121150	TY 00590-42110	TY 00591-23043-81
RA 570-260-511	TY 00591-42661-81	YT 220017761
TY 00590-41853		



Part Number - 074604

Brush

0.500 D X 0.625 W x 1.750 L

▼ OEM Reference

BR 16954-007	HY 800076129	TY 00591-51482-81
BR 28802-014	TY 00591-04685-81	YT 220015861
BR A16954-7	TY 00591-04685-81	YT 220016545
CT 215023	TY 00591-32390-81	YT 220054093



Part Number - 074614

Brush Set

▼ OEM Reference

AC 4906521	HY 3007446	TY 00591-30135-81
AC 74906521	HY 3018819	TY 00591-51472-81
BJ 003704	PL 17-63	YT 129159026
BK 116088	PL MBD-1418-S	YT 220008074
BK 15MP9A	PM 200185	YT 220023298
CL 883802	PM EMBD-1418-S	YT 500838400
CT 973039	RA 570-416-06	YT 506605800
HY 3001328	SC 33-11408	YT 1169404DX
HY 3002686	SC 41-25683	YT 1291590-26



Part Number - 084304

Brush Set

▼ OEM Reference

AC 4907386	HY 3001857	SC 33-11417
AC 4912263	HY 800071662	TY 00591-03981-81
BK 004327	PL 17-149	TY 00591-30634-81
CL 991251	PL 17-159	TY 00591-51471-81
HY 241365	PL 17-183	YT 220051431
HY 365180	PL MHR-2012-AS	YT 507413800
HY 3001236	PL MHR-2012-BS	YT 509016814
HY 3001334	PL MHR-2012-S	YT 509016816
HY 3001855	SC 33-11412	



Part Number - 370331

Brush Set (Set of 2)

▼ OEM Reference

RA 200188/NB



Part Number - 087233

Brush Set (Set of 8)

▼ OEM Reference

BJ 003772	HY A-120311	RA 570-433-214
CL 893724	PL 17-216	TY 00591-04137-81
CL 999426	PL 17-227	TY 00591-14088-81
HY 1198441	PL 17-87	TY 00591-31765-81
HY 3006288	PL MCP-2012-KS	TY 00591-33335-81
HY 3007481	PL MFH-1012S	TY 00591-56357-81
HY 3013766	PL MTD-1012-S	TY 00591-56436-81
HY 800072005	RA 570-433-02	YT 220002716
HY 800108167		



Part Number - 087522

Brush Set

0.27 D x 0.76 W x 0.87 L

▼ OEM Reference

CL 68587	PL 17-203	TY 00591-51456-81
CL 999158	PL 17-223	TY 00591-64378-81
CT 215781	PL MAD-1512-AS	YT 220023631
HY 0328114	PL MBD-1512-S	YT 220051433
HY 328114	PM 200188	YT 509016821
HY 0328914	PM EMBD-1512-S	YT 518264883
HY 3002679	TY 00591-32452-81	YT 5090168-21
HY 3053018	TY 00591-42281-81	



Part Number - 090276

Brush Set (Set of 4)

0.500 D x 1.265 W x 1.376 L

▼ OEM Reference

CL 892234	HY 228615	PM EMEA-1012BS
CL 905878	HY 288201	RA 570-437-02
CL 988646	PL MEA-1012AS	RA 570-437-211
CL 998642	PM EEME-1012CS	TY 00591-42276-81
CL 998646		



Part Number - 087393
Brush Set (Set of 8)
 0.550 D x 1.000 W x 1.385 L
 ▼ OEM Reference
 PL MTE-1012S
 YT 220041853



Part Number - 093585
Brush Set (Set of 4)
 0.405 D x 0.855 W x 1.430 L
 ▼ OEM Reference
 HY 0360804 TY 00591-05090-81
 HY 3012559 TY 00591-33328-81
 HY 800076793 TY 00591-60732-81



Part Number - 370530
Brush Set (4)
 ▼ OEM Reference
 RA 570-869-551



Part Number - 094843
Brush Set (Set of 4)
 ▼ OEM Reference
 AC 4914589 HY 3006290 PM 200248
 AC 4916087 PL 17-188 PM EMGQ-2012-BS
 BR 28829-059 PL 17-193 RA 570-205-04
 CL 906578 PL 17-235 RA 570-436-04
 CL 998234 PL MGQ-2012-AS TY 00591-32476-81
 CL 1819404 PL MGQ-2012-BS YT 5090168-19
 CT 973515 PL MGQ-2012-S
 CT 973516 PM 200021



Part Number - 100730
Brush Set (Set of 4)
 ▼ OEM Reference
 CT 928965 RA 570-215-219 TY 00591-32471-81
 CT 973756 RA 570-240-115 TY 00591-42278-81
 CT 1036558 RA 570-241-114 TY 00591-52520-81
 HY 360809 TY 00591-04168-81



Part Number - 103842
Brush
 ▼ OEM Reference
 BR 16954-008 BR A16954-9 TY 00591-51464-81
 BR 16954-009 CT 973863 TY 00591-56396-81
 BR 16954-014 HY 3012562 YT 220003254
 BR 28802-015 TY 00591-30254-81 YT 220016358
 BR A16954-8 TY 00591-33355-81 YT 220023635



Part Number - 104868
Brush
 0.500 D x 0.625 W x 1.445 L
 ▼ OEM Reference

BK 129964	HY 3007484	TY 00591-52523-81
BR 16954-015	HY 3012560	YT 220007694
BR 16954-015S	HY 3031310	YT 220007703
BT 300300-000	HY 3057512	YT 220013162
CL 1893222	HY 3131910	YT 220023510
CT 216357	HY 3144747	YT 220037512
DS P221-1043	PM 300300000	YT 220044747
GE 625A649AK5	TC FA72E1-05672	YT 220075082
HY 1309377	TY 00591-04239-81	YT 504230259
HY 1309385	TY 00591-32456-81	YT 504237261
HY 1346277	TY 00591-33332-81	YT 518805656
HY 1376980	TY 00591-43681-81	YT 580028320
HY 3007439	TY 00591-51466-81	



Part Number - 073854
Brush
 0.375 D X 0.750 W x 0.786 L
 ▼ OEM Reference

TY 00591-04670-81	TY 00591-60651-81
TY 00591-33331-81	YT 220016331



Part Number - 370275
Brush Set (Set of 4)
 0.370 D x 0.615 W x 1.130 L
 ▼ OEM Reference
 TY 14543-U1090-71



Part Number - 104888
Brush Set (Set of 8)
 0.548 D x 0.997 W x 1.500 L
 ▼ OEM Reference

CT 1049941	TY 00591-04241-81	TY 00591-52524-81
CT 1049942	TY 00591-32457-81	YT 220010146
RA 570-236-114	TY 00591-42283-81	YT 220015020



Part Number - 107304
Brush Set
 ▼ OEM Reference
 HY 800075206
 TY 00591-20030-81
 TY 00591-33326-81
 TY 00591-60552-81



Part Number - 107312
Brush Set
 ▼ OEM Reference
 BR 27327-215
 BR 27327-216
 TY 00591-52527-81
 YT 220015280



Part Number - 109953

Brush
0.500 D x 1.250 W x 1.625 L

▼ OEM Reference

HY 1335385	TY 00591-63177-81	YT 580011010
HY 1462472	TY 220013161	
TY 00591-33292-81	TY 220026265	



Part Number - 113328

Brush Set (Set of 4)
0.62 D x 1.25 W x 1.34 L

▼ OEM Reference

HY 800075249	RA DS227871	YT 220015628
RA 570-240-229	TY 00591-04291-81	YT 220023517
RA 570-252-517	TY 00591-33327-81	
RA 570-447-513	TY 00591-52528-81	



Part Number - 110200

Brush
0.500 D x 1.125 W x 1.450 L

▼ OEM Reference

BG 030-807	HY 3054719	TY 00591-60319-81
HY 362118	KO 3BA-18-25490	TY 14344-U1090-71
HY 389722	TY 00591-04288-81	YT 220044108
HY 2013288	TY 00591-32469-81	



Part Number - 116363

Brush Set (4 of 110200)
0.500 D x 1.125 W x 1.450 L

▼ OEM Reference

TY 00591-33334-81
TY 00591-56409-81
YT 220018823



Part Number - 113498

Brush
0.815 D x 0.37 W x 3.092 L

▼ OEM Reference

HY 3121436
YT 220018132



Part Number - 113652

Brush Set (Set of 4)
0.628 D x 1.240 W x 1.300 L

▼ OEM Reference

TY 00591-42668-81
YT 220015245



Part Number - 370273

Brush Set (4 pairs)
0.495 D x 2.235 W x 1.375 L

▼ OEM Reference

DX 1402083



Part Number - 114502

Brush Set (Set of 4)
0.488 D x 1.242 W x 1.300 L

▼ OEM Reference

HY 3033370
YT 220015301



Part Number - 111768

Brush
0.625 D x 1.125 W x 1.750 L

▼ OEM Reference

CT 973810	HY 1386170	TY 00591-06234-81
CT 9722002800	KO 3BB-17-A3340	TY 00591-32462-81
GE 36A291746AC002	MB 9722002800	TY 00591-60320-81
GE 36A291746ACP02	MB SE000168	TY 14147-U2090-71
GM 0105-5919	NI 29142-8G201	YT 220070227
HY 364674	TC FA72G1-05142	YT 520045399



Part Number - 114541

Brush Set (Set of 8)

▼ OEM Reference

HY 3144797
YT 220044797



Part Number - 370271

Brush Set (Set of 8)
0.500 D x 1.555 W x 1.500 L

▼ OEM Reference

TY 14351-21440-71



Part Number - 370272
Brush Set (Set of 4)
 0.625 D x 0.960 W x 1.300 L

▼ OEM Reference
 TY 00590-41782-71



Part Number - 370274
Brush Set (Set of 4)
 0.625 D x 1.240 W x 1.305 L

▼ OEM Reference
 CT 97020-10170
 MB 97020-10170



Part Number - 114671
Brush Set (Set of 4)

▼ OEM Reference
 RA 570-235-513
 RA 570-317-515
 RA 570-383-512
 YT 220018821



Part Number - 111136
Brush Set (Set of 4)

▼ OEM Reference
 RA 570-427-516
 TY 00591-42667-81
 YT 220029734



Part Number - 087713
Brush Set (Set of 8)

▼ OEM Reference
 PL 17-218
 PL MEA-1012BS
 TY 00591-30635-81
 TY 00591-60718-81

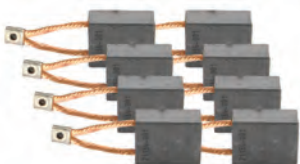

Part Number - 116961
Brush Set (Set of 8)
 0.628 D x 1.247 W x 1.500 L

▼ OEM Reference
 YT 220043258



Part Number - 118913
Brush Set (Set of 4)

▼ OEM Reference

CT 1092493	MB 1203335	RA DS232755
CT 1203335	MB NA012195	TY 00590-04748-71
CT NA012195	MB NA013903	TY 00591-42678-81
CT NA013903	RA 570-268-515	YT 220018826
HY 3122590	RA 570-316-516	YT 220029109
HY 3137109	RA 570-334-512	
MB 1202335	RA 570-360-511	



Part Number - 125020
Brush Set

▼ OEM Reference
 HY 3135864
 YT 220036158



Part Number - 370149
Brush w/BWI (Set of 2)

▼ OEM Reference
 HY 1507462
 YT 580029663



Part Number - 370150
Brush

▼ OEM Reference
 CL 2307487
 CT A0000-13061
 HY 2307487
 MB A0000-13061
 YT 520344803
 YT 582004027



Part Number - 370151
Brush Kit (Set of 4)

▼ OEM Reference
 CT 07125-06700
 CT 97125-06700
 HY 1459684
 MB 07125-06700
 MB 97125-06700
 TY 14543-U1160-71
 YT 580007602



Part Number - 370152
Brush (Set of 2)

▼ OEM Reference
 CT 1058341
 GE 36A291850AHP02
 GE 36A291850AHP03
 GM 0105-6637
 HY 366090
 HY 1312816
 HY 3056409
 HY 3057511
 HY 3144107
 HY 3144124
 MB 1058341
 NI 29142-8G000
 TY 00591-06236-81
 TY 00591-56410-81
 YT 220037511
 YT 220044107
 YT 220044124
 YT 220075064
 YT 504229255
 YT 504229274
 YT 519466014



Part Number - 100358
Brush & Lug Assembly

▼ OEM Reference
 TY 00591-42669-81



Part Number - 021158-001
Brush

0.49 D X 0.97 W x 1.30 L
 ▼ OEM Reference
 YT 220026664



Part Number - 370237
Brush Set (1 Piece)
 ▼ OEM Reference
 LI 0009718156



Part Number - 370247
Brush Set (Set of 4)
 0.880 D x 0.880 W x 0.880 L
 ▼ OEM Reference
 RA 1016523-215



Part Number - 370239
Brush Kit (Set of 4)
 ▼ OEM Reference
 HY 1461570
 YT 580010369



Part Number - 370248
Brush Set (1 Pair)
 0.280 D x 0.880 W x 0.880 L
 ▼ OEM Reference
 RA 570-237-218



Part Number - 370240
Brush
 ▼ OEM Reference
 HY 1502113
 YT 580027030



Part Number - 370042
Drive Motor Brush Set with Springs (Set of 4)
 0.350 D x 0.5000 W x 0.950 L
 ▼ OEM Reference
 HY 1506791
 YT 580029149



Part Number - 370241
Brush Set (Set of 2)
 ▼ OEM Reference
 HY 2034133
 YT 582004043



Part Number - 370154
Brush & Spring
 ▼ OEM Reference
 CL 912404 TY 00591-56450-81 YT 521558001
 HY 3039096 YT 220017107 YT 521558002
 PM 202028 YT 519578814
 TY 00591-33323-81 YT 519578824



Part Number - 370242
Brush Set (1 Pair)
 ▼ OEM Reference
 HY 1389604
 YT 723791145



Part Number - 125789
Brush & Spring Set
 ▼ OEM Reference
 BK 152156 CL 929325 TY 00590-40635-71
 BR 27327-287 HY 1463273 YT 519616815
 BR 27327-293 RA 560-213-07
 BR 69580-FS000 RA 850-139-013



Part Number - 370244
Brush
 ▼ OEM Reference
 TY 14181-11480-71
 TY 14112-12240-71



Part Number - 084548
Ring Brush Assembly

▼ OEM Reference

AC 4911482	HY 3019763	YT 504223284
CL 906294	TY 00591-30163-81	YT 518264803
HY 0286080	YT 220002204	YT 518264826
HY 3017806	YT 220079575	YT 518264835



Part Number - 107090
Brush Spring Set (Set of 4)

▼ OEM Reference

CL 7004330	PL 50-525	TY 00591-64383-81
CT 1036520	RA 570-240-119	YT 220007922
CT 1050062	RA 570-249-213	YT 220034592
DW A200836	TY 00591-42287-81	



Part Number - 020018
Brush Box Assembly

▼ OEM Reference

BK 709652	HY 360810	TY 00591-42335-81
CL 910218	PL 36-1175	TY 00591-64431-81
CL 913225	PM 200065	YT 220029198
CL 7004338	RA 570-215-216	YT 220054705
CT 1036517	TY 00591-17521-81	



Part Number - 076481
Brush Spring Set (Set of 4)

▼ OEM Reference

AC 1009710	CL 6517648	TY 00591-51366-81
AC 4906486	CT 311022	YT 015948600
AC 71009710	CT 1009189	YT 023403100
AC 74906486	HY 0055613	YT 023403400
BK 993459	HY 0238760	YT 052041100
BK 12MP32	HY 1198105	YT 056210400
BK 94MBY1	HY A-98629	YT 058786800
BK EP311	PL 50-263	YT 066158200
BK EP311A	PL MZ-19-S	YT 129159024
BK EP477	PM 200305	YT 220051365
BR 27327-038	PM EMZ-19S	YT 505104800
BR 27327-199	RA 560-010-12	YT 506273800
BR 27793-011	RA 570-417-08	YT 1169404DH
CL 68866	SC 33-11452	YT 6066614AC
CL 893682	TY 00591-41490-81	



Part Number - 100729
Brush Plate

▼ OEM Reference
RA 570-240-116



Part Number - 082661
Brush Holder

▼ OEM Reference

AC 74912772	HY 0275047	RA 570-413-06
BK 115114	HY 0317714	RA 570-415-18
CL 905799	HY 1199508	SC 33-11361
CL 906182	HY 3052917	SC 33-11368
CL 991548	PL 90-2710	TY 00591-35188-81
CL 994644	PL MEE-1164	YT 220051425
CL 999470	PM 200148	YT 509015804
CT 216387	PM E-90-2495	YT 511274800
	PM E-90-2596	
	PM E-90-2710	



Part Number - 087398
Brush Spring

▼ OEM Reference

AC 4911483	HY 0286082	PM 300665-001
AC 4968002	HY 3002482	TY 00591-03656-81
BK 112546	HY 3003312	TY 00591-32165-81
CL 906301	HY 3052676	TY 00591-51371-81
CL 909820	KO 3BB-19-24560	YT 220051868
CL 915801	ME B240501	YT 504228298
CT 0973392	OH B240501	YT 518264804



Part Number - 074606
Brush Spring

▼ OEM Reference

BR 22393-016	HY 800076131	YT 054038000
CL 7003934	TY 00591-32135-81	YT 220017582
HY 3012785	TY 00591-56262-81	



Part Number - 078496
Brush Spring Set (Set of 4)

▼ OEM Reference

AC 4905999	HY 3001792	RA 570-414-08
BJ 003711	HY A-134258	RA 570-415-10
BJ 900136	HY A-144545	SC 33-11456
BK 108782	ME MGP18SS	TC 2002410
BK 993956	ME SMP12-470	TC EMGP18SS0
BR 28829-058	ME SMP12-472	TY 00591-41515-81
CL 908767	PL 50-368	TY 00591-51363-81
CL 980767	PL MGP-18-SS	YT 220023441
CT 0973393	PM 200241	YT 220051423
HY 1144545	PM 30556-00	YT 509014801
HY 1198953	PM EMGP-18-SS	
HY 1199363	RA 570-236-113	



Part Number - 087884
Brush Spring

▼ OEM Reference

BK 129963	RA 570-115-115	TA 85-412-00
CL 7003964	RA 570-445-214	TY 00591-32166-81

Motor and Hydraulic



Part Number - 125918

Brush Spring

▼ OEM Reference

CL 915596	HY 800071351	TY 00591-42623-81
HY 3145024	PM 300418-000	YT 220028029
HY 800017481	TY 00591-03828-81	YT 220045024



Part Number - 370529

Oil Seal

▼ OEM Reference

AC 8735227	HY 3134578	MB NA57010
AC OP03000139	KO 8735227	RA 570-262-218
CT 1134235	KO OP03000139	RA 570-262-518
CT 1135235	MB 1134235	RA 570-279-511
CT A000018358	MB 1135235	RA DS223622
CT NA012923	MB A000018358	TY 00591-72102-81
CT NA57010	MB NA012923	YT 220027809



Part Number - 370144

Seal

▼ OEM Reference

CL 7003816	RA 530-615	WM 20-P-68
CT GS0000888	TY 00591-41247-81	WM 21-H-3325
CT 1062983	TY 00591-54596-81	WM 30-P-575
HY 3013840	WM 20-H-1160	WM 403692-D
MB GS0000888	WM 20-P-358	YT 220003634
RA DS225024	WM 20-P-4191	YT 220016555



Part Number - 370056

Fitting

▼ OEM Reference

HY 2309185
YT 504114800



Part Number - 370208

Reservoir

▼ OEM Reference

CL 3798160	HY 3038235	RA 870-903
CL 8027617	JU 27602230	TY 00591-35395-81
CL 6035-10870	JU 27623760	TY 00591-58049-81
CT 27602230	MB 0802082	YT 220012366
CT 27623760	MB 802082	YT 220017463
CT 398724	MB 27602230	YT 252370600
CT 802082	MB 27623760	YT 580006015
HY 1300155	MB W505010139	YT 580021039
HY 1489805	MB W5050-10139	
HY 2305052	NI 6035-10870	



Part Number - 370157

Seal

▼ OEM Reference

BK 001383	HY 3050644	TY 00591-32048-81
BK 12AL213	HY 3131031	TY 00591-58736-81
CL 7003779	KO 37B-7AV-1211	YT 220006678
CT 215622	LI 001383	YT 220022631
HY 0046671	TY 00591-00174-81	

Cylinders/Seal Kits

Continued ▶



Part Number - 370199

Master Cylinder

▼ OEM Reference

BR B-19121-4	HY 3038442	RA 824-900-003-002
BR B19121-4	HY 3121012	RA 824-900-003-003
BR D-19121-14	RA 1009641	RA 870-614-100
BR 19121-004	RA 1011257-100	RA 870-614
CL 7001018	RA 820-001-687	TY 00591-21103-81
CT NA019019	RA 820-001-688	TY 00591-30176-81
CT 1036894	RA 821-900-040-001	TY 00591-30243-81
DS P261-0013	RA 821-900-040-002	TY 00591-52201-81
GM 0246-M9XA	RA 821-900-040-1	TY 00591-53118-81
HY 3007219	RA 821-900-040	YT 220007708
HY 3007688	RA 824-900-003-001	YT 220018189



Part Number - 370203

Master Cylinder

▼ OEM Reference

MB A0000-30255
RA 870-630-100



Part Number - 370525

Master Cylinder

▼ OEM Reference

RA 870-896-001
RA 870-896-003



Part Number - 370204

Master Cylinder

▼ OEM Reference

RA 870-896-002
RA 870-896-004



Part Number - 370536

Master Cylinder

▼ OEM Reference

RA 828-900-096-102



Part Number - 370515

Tilt Cylinder Assembly

▼ OEM Reference

RA 540-084

Cylinders/Seal Kits



Part Number - 370029
Seal Kit Lift Cylinder

▼ OEM Reference
HY 2307177 TY 00591-42560-81
HY 3054871 TY 00591-60896-81



Part Number - 370489
Seal Kit

▼ OEM Reference
TY 04652-U2040-71
TY 04652-U2070-71



Part Number - 370537
Seal

▼ OEM Reference
CT 1036492 RA 530-633 YT 220016032
HY 3013928 RA DS232952
MB 1036492 TY 00591-76028-81

Miscellaneous

Continued ▶



Part Number - 351096-308
Pallet Clamp Release Cable

▼ OEM Reference
RA 1085703



Part Number - 370716
Hose Clamp

▼ OEM Reference
CT A0000-30113
MB A0000-30113
TY 68651-23470-71



Part Number - 351096-264
Cable Pallet Grab

▼ OEM Reference
CT 1037081 RA 114-008-507 YT 220036691
HY 3135828 RA 114-009-664
MB 1037081 TY 00591-75898-81



Part Number - 370725
Center Cylinder Pulley

▼ OEM Reference
TY 68804-25160-71



Part Number - 351096-335
Pulley

▼ OEM Reference
RA 1197851



Part Number - 370501-798
Speed Sensor

▼ OEM Reference
HY 1541232
TY 580056272



Part Number - 370465
Guard-String Cutter

▼ OEM Reference
BR 40373-FS000
NI 40373-FS000

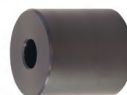

Part Number - 370106
Roller

▼ OEM Reference
CT 1051077 RA 123-001-382 TY 00591-70714-81
HY 3034352 RA 828-005-498 YT 220015913
RA DS223092 RA 828-006-726



Part Number - 370513
Screw

▼ OEM Reference
RA 715-037
RA 715-037-100



Part Number - 360038-271
Bumper (2 Required)

▼ OEM Reference
HY 2050084
TY 524149326



Part Number - GN100195GT
Replacement Power Cord AC
 ■ 6' 7" L
 ■ 300v
 ■ 15 amp, 13 amp plug
 ▼ OEM Reference
 DEKA IMP-9412
 ⚠ **WARNING:** Cancer and Reproductive Harm - www.P65Warnings.ca.gov



Part Number - 142669
Replacement Power Cord
 ■ 10 ft. long
 ■ 300v
 ■ 15 amp, 15 amp plug



Part Number - 126711
Replacement Charger Cord AC
 ■ 8.2 ft. long
 ■ 125VAC
 ■ 15 amp
 ▼ OEM Reference
 DEKA IMP-9409
 DEKA SA4081



Part Number - 396351
Replacement Power Cord AC



Part Number - 396354
Replacement Power Cord
 ■ 18" of straight cord, female end to spiral cord
 ■ For Zivan charger
 ▼ OEM Reference
 GNB V04ZIVANPLUG



Part Number - 396350
Replacement Power Cord
 ■ 12" of straight cord on either side of 12" constricted spiral cord (60" total) length.
 ■ For Zivan charger
 ▼ OEM Reference
 GNB V04SPRLCORD



Part Number - 104164-007
Solenoid Coil
 ▼ OEM Reference
 YL 580038835
 ⚠ **WARNING:** Cancer and reproductive harm - www.P65Warnings.ca.gov



Part Number - 351096-321
Relay

▼ OEM Reference

CL	448350	MB	NA010027	RA	1-100-075
CT	GS00-00035	RA	0055111CE	RA	DS223172
CT	NA010027	RA	0055276CE	TY	00591-75890-81
MB	GS00-00035	RA	1-100-067		



Part Number - 370073
Horn Contact

▼ OEM Reference
 TY 57413-22500
 TY 57413-22500



Part Number - 370079
Horn Contact

▼ OEM Reference
 TY 57415-23600-71
 YT 220034250



Part Number - 370341
Horn Contact

▼ OEM Reference
 TY 57457-13500-71



Part Number - 398000-067
Horn Plunger

▼ OEM Reference
 CT 91354-12600
 MB 91354-12600
 RA DS235362
 YT 220034070



Part Number - 370062
Horn Contact - Ring

▼ OEM Reference
 TY 45123-23600-71



Part Number - 370083
Horn Contact - Ring

▼ OEM Reference

HY	3141503	TY	45112-22001-71	YT	220041503
TY	45112-22000-71	TY	45112-22002-71		



Part Number - 370084
Horn Contact - Ring
 ▼ OEM Reference
 HY 3122944
 TY 45111-23000-71
 YT 220018881



Part Number - 370063
Horn Contact - Spring
 ▼ OEM Reference
 TY 45124-23600-71



Part Number - 398000-153
Horn Contact Case
 ▼ OEM Reference
 CT A0000-28794
 MB A0000-28794
 YT 45120-12240-71



Part Number - 370081
Horn Plate
 ▼ OEM Reference
 CT A000014902
 TY 00591-71832-81
 TY 45113-22500-71
 YT 220019121



Part Number - 370080
Horn Plate
 ▼ OEM Reference
 HY 3003064
 TY 45116-20540-71
 TY 45116-20540
 YT 220076629



Part Number - 380030-203
Horn Contact
 ▼ OEM Reference
 CT 91A06-09700
 MB 91A06-09700
 NI 25569-FK000



Part Number - 380030-196
Horn Spring
 ▼ OEM Reference
 NI 48425-FJ100



Part Number - 370064
Horn Contact - Spring
 ▼ OEM Reference
 TY 57414-22500-71



Part Number - 370082
Horn Spring
 ▼ OEM Reference
 TY 45115-22500-71
 YT 220018884

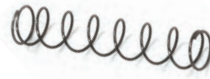

Part Number - 370085
Horn Spring
 ▼ OEM Reference
 TY 57414-23600-71



Part Number - 370342
Horn Spring
 ▼ OEM Reference
 TY 57458-13500-71



Part Number - 398000-066
Horn Spring
 ▼ OEM Reference
 BR NF91354-05600
 CT 91354-05600
 MB 91354-05600
 NI NF91354-05600



Part Number - 370086
Horn Spring
 ▼ OEM Reference
 HY 3046967
 TY 45112-20540-71
 YT 220010769



Part Number - 398000-064
Horn Spring
 ▼ OEM Reference
 BR NF91255-01800
 BT DS237820
 CT 1015387
 CT 91255-01800
 CT 9125501800
 HY 3120942
 MB 1015387
 MB 91255-01800
 MB 9125501800
 NI NF91255-01800
 PM DS237820
 RA DS237820
 YT 220019513



Part Number - 370506
Switch - Horn Button (Universal)
 ▼ OEM Reference

AC 652426	HY 1194764	RA 590-095
AC D1972351	HY 3007556	RA 600-927
AC DU1960	HY 3012820	RA 812-001-256
BK SW61	HY 3143153	TY 00591-07608-81
CL 445653	HY A3178	TY 00591-41812-81
CL 7004244	KO 652426	TY 00591-41987-81
CL 857259	KO D1972351	TY 00591-51942-81
CT 215589	KO DU1960	TY 00591-57432-81
CT 215591	LI SW61	YT 051244600
CT 973024	MB 215589	YT 065242600
CT 973029	MB 215591	YT 220002759
HY 0003178	MB 973024	YT 220043153
HY 0012820	MB 973029	YT 610196100



Part Number - 380700-007
Horn Switch
 ▼ OEM Reference

BT 1-150-429	PM 1-150-429AM	RA DS228500
BT 1-150-429AM	PM DS228500	TY 00590-02628-71
BT DS228500	RA 1-150-429	
PM 1-150-429	RA 1-150-429AM	



Part Number - 370756
Switch - Emergency Disconnect/Stop

▼ OEM Reference

HY 2306364	HY 294000	TY 00591-74634-81
HY 283984	HY 294009	YT 504575269



Part Number - 370554
Spring

▼ OEM Reference

RA 830-340
RA 830-347
RA DS224394



Part Number - 360038-277
Spring

▼ OEM Reference

AC 46490
BT 46490
KO 46490
PM 46490
RA 46490



Part Number - 370146
AC Cord & Plug

▼ OEM Reference
 YT 644087802



Part Number - 370503
Return Spring

▼ OEM Reference

RA 312855-001



Part Number - 380700-004
Temp Sensor

▼ OEM Reference

BT 308123-000	HY 3145025	RA 828-003-420/002
BT 828-003-420/002	MB 1051330	RA 828-003-420/004
BT 828-003-420/004	PM 308123-000	RA 828-003-420/006
BT 828-003-420/006	PM 828-003-420/002	RA DS224081
BT DS224081	PM 828-003-420/004	TY 00591-76106-81
CT 1051330	PM 828-003-420/006	YT 220034275
GM 0256-04HF	PM DS224081	YT 220045025
HY 3135188	RA 308123-000	

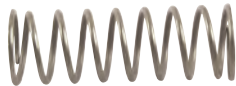

Part Number - 370504
Spring

▼ OEM Reference

BT 1036742
PM 1036742
RA 1036742



Part Number - 370440
Spring Side Tracker

▼ OEM Reference

BR 48488-FS007
NI 48488-FS007



Part Number - 370539
Spring

▼ OEM Reference

CL 7003962	MB A0000-00164	TY 00591-53119-81
CL 7004016	RA 830-174	TY 00591-70167-81
CT A0000-00164	RA 830-229	YT 220001756
HY 3005737	TY 00591-30964-81	
HY 3033885	TY 00591-32163-81	



Part Number - 370057
Wire Harness

▼ OEM Reference

YT 524149943
HY 2047806



Part Number - 370026
Wiring Harness Assembly

▼ OEM Reference

HY 2307607
YT 503918700



Part Number - 370553
Spring

▼ OEM Reference

CT 1055730	MB 1055730	TY 00591-21098-81
CT 219528	MB 219528	YT 220019545
HY 3039498	RA 830-050	YT 220024344
HY 3132744	RA DS232536	



Part Number - 370340
Insulator
 ▼ OEM Reference
 TY 14213-21400-71



Part Number - 370306
Washer
 ▼ OEM Reference
 AC 11857-20 PM 11857-20
 BT 11857-20 RA 11857-20
 KO 11857-20



Part Number - 370221
Bolt
 ▼ OEM Reference
 CT 51023801 JU 51058719 MB W2050-13429
 CT 51058719 MB 51023801 MB W2050-13534
 JU 51023801 MB 51058719



Part Number - 370290
Lockwasher
 ▼ OEM Reference
 HY 15918
 YT 03258600
 YT 3258600



Part Number - 370051
Battery Cover Knob
 ▼ OEM Reference
 HY 2033545
 YT 721528104



Part Number - 370287
Ball
 ▼ OEM Reference
 HY 278374 HY 2039858
 HY 379190 YT 524141136



Part Number - 370333
Symbol Plate
 ▼ OEM Reference
 BT 171583 PM 171583 RA 851-201-178
 HY 800140840 RA 171583



Part Number - 380700-027
Ball 9/16 - Chrome Steel
 ▼ OEM Reference
 RA RA850-017



Part Number - 370335
Lever Plate
 ▼ OEM Reference
 CL 1808135



Part Number - 370320
Shoe, Skid
 ▼ OEM Reference
 AC 313494-000 PM 313494-000
 BT 313494-000 RA 313494-000
 KO 313494-000



Part Number - 370343
Lever Display
 ▼ OEM Reference
 YT 582005136



Part Number - 370330
Prop Button w/Switch-C
 ▼ OEM Reference
 HY 800130355 YT 524148522 YT 582003465



Part Number - 370069
Transistor
 ▼ OEM Reference
 NI 29327-15K00 RA 1-125-014 RA DS223474
 NI 29327-15K01 RA 828-900-101 TY 90891-03006-71



Part Number - 370544
Spacer
 ▼ OEM Reference
 BT 623-003-120 MB 1063126 TY 00590-48484-71
 CL 7002134 PM 623-003-120 TY 00591-37571-81
 CT 1063126 RA 623-003-120 TY 00591-74106-81
 HY 3016084 RA DS232309 YT 220002075



Part Number - 351096-319
Transistor Kit
 ▼ OEM Reference
 RA 1133904

Miscellaneous



Part Number - 370513

Screw

▼ OEM Reference
 RA 715-037
 RA 715-037-100



Part Number - 370561

Shim

▼ OEM Reference
 CL 7003231 MB 1036847 TY 00591-39911-81
 CT 1036847 RA 623-019-000 YT 220002691
 HY 3007210 RA DS232716



Part Number - 370516

Spacer

▼ OEM Reference
 CL 7002211 MB 1051247 TY 00591-37670-81
 CT 1051247 MB 217869 YT 220027925
 CT 217869 RA 820-001-542 YT 220034052
 HY 3015111 RA 824-000-390



Part Number - 370545

Shim

▼ OEM Reference
 CL 7003230 MB 1036848 TY 00591-39910-81
 CT 1036848 RA 623-020-000 YT 220002693
 HY 3007214 RA DS232717



Part Number - 370528

Ring

▼ OEM Reference
 CL 7002217 MB 1055778 YT 220021117
 CT 1055778 RA 116-000-331
 HY 3125804 TY 00591-37678-81



Part Number - 370546

Bolt

▼ OEM Reference
 CL 7002228 MB 1051246 YT 220002062
 CT 1051246 RA 824-000-382
 HY 3015955 TY 00591-37693-81



Part Number - 370569

Screw

▼ OEM Reference
 RA 301922-100



Part Number - 370547

Lug Bolt EZ Reach

Used on Hub 358005

▼ OEM Reference
 BT 312206-000 MB 1051305 RA 828-003-193
 CT 1051305 PM 312206-000 RA DS236735
 HY 3039669 RA 312206-000 YT 220017073



Part Number - 370540

Screw

▼ OEM Reference
 CT NA013590 MB NA013590 RA DS226465
 HY 3126421 RA 5-003-019



Part Number - 370538

Shim

▼ OEM Reference
 CT 219526 RA 771-040 YT 220008914
 HY 3014635 RA 771-147
 MB 219526 TY 00591-70381-81



Part Number - 398000-059

Universal Decal Kit

▼ OEM Reference
 TY 00591-07802-81

Section 5

Internal Combustion (IC) Truck Components

Contents

Seats/Replacement Parts	5.02
Seat Belts	5.09
LPG Tanks	5.10
Fuel/LPG	5.11
Starters/Replacement Parts	5.15
Pumps/Parts	5.18
Alternators	5.20
Radiators and Accessories	5.22
Miscellaneous Brake Parts	5.26
Pipes	5.32
Cylinders/Parts	5.33
Tune-Up Kits and Planned Maintenance Kits	5.37
Distributors/Caps, Rotors, Spark Plug Wires	5.38
Coils	5.42
Spark Plugs	5.43
Fan Blades	5.45
Belts	5.46
Seals	5.48
Drive Train	5.52
Miscellaneous	5.55

Note: 1910.178(q)(5) (1998) of the Occupational Safety and Health Act (OSHA) requires that "All parts of any such industrial truck requiring replacement shall be replaced only by parts equivalent as to safety with those used in the original design."

The installation onto a lift truck of non-certified electronic components may invalidate a truck's UL EE or LPS listing and could pose a safety risk. Customers with UL-listed lift trucks are solely responsible for ensuring compliance with UL for field modifications. The selection of non-OEM parts is made solely by the customer with the awareness that OEM parts are available. Crown Equipment Corporation is unaware of what testing and/or certification, if any, the non-OEM parts have undergone and disclaims all warranties and representations regarding any non-OEM part.

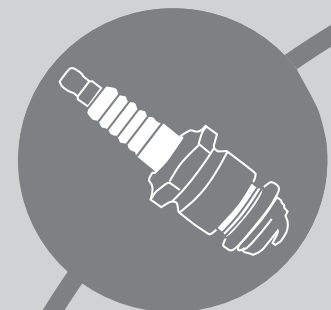



Part Number - 380070-001

**Lumbar Seat
Forward Tilt & Fold Back**

Part Number - 380070-001-E
Seat with Electric Switch

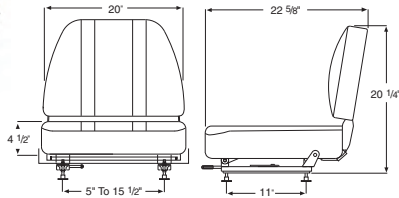

- Seat belt brackets
- Heavy duty 3/4" tubular frame with Flex-O-Lator & coil spring support
- 6" fore & aft adjusters 11" O/C front to rear mount
- 5" to 15 1/2" lateral adjustment
- 1.4 lb. density foam pack with 55 lb. compression foam cushion

▼ OEM Reference

AF 00440	IN STWM599	TC 24846-80302
CT 973522	LP 753-7035	TC 27416-80201
ET 32002	LP WM-599	TC 27416-80202
ET 32106	NI 87000-60K05	TY 00591-07835-81
HM MODEL100	NI 87000-L2000	TY 00591-07876-81
HM MODEL100-ELE	NI 87000-L2100	TY 00591-30008-81
HY 3022576	NI FLPRSS000	TY 00591-58448-81
HY 3029291	SY 800116885	YT 150016902
HY 3030127	SY 1862	YT 150016903
HY 3031084	TC 22196-82001	YT 150039503
IN 85-347	TC 23656-80102	YT 150039766
IN ST973522	TC 24846-80301	



Part Number - 380070-015

**Injection Molded Seat
Straight Back**

Part Number - 380070-015-E
Seat with Electric Switch

Switch P.N. 380030-182

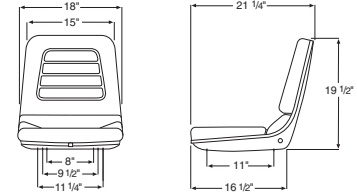

- Molded 1-PC seat assembly
- Heavy 14 gauge steel frame with black powder coat finish
- 6" fore & aft adjusters 11" O/C mounting
- 8"-9 1/2"-11 1/4"-18" lateral adjustment
- Hip restraints mounting
- Contoured molded foam for optimum body support
- 67 mil. heavy duty black molded cover

▼ OEM Reference

AF 00439	HY 138081	IN STWM1183
ET 32005	HY 192268	LP 753-7022
ET 32005-WS	HY 364911	ST WM1183
GM 0706-1943	HY 377904	SY 1732
HM MODEL1500	HY 377967	SY 1769
HM MODEL1500-ELE	HY 806441	TY 00591-32859-81
HY 127504	HY 3032277	TY 00591-58466-81
HY 130798	HY 3054800	YT 220013187
HY 130799	HY 3058160	YT 504232248
HY 130800	IN 85-137	YT 504236274



Part Number - 380070-013

**Full Body Seat
Forward Tilt and Fold Back**

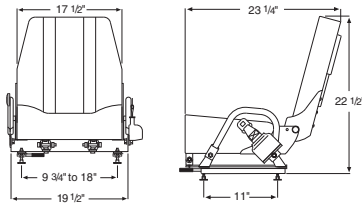

- With Retractable Seat Belt
- Heavy duty steel frame with black enamel finish
- 6" fore & aft adjusters 11" O/C front to rear mount
- 9 3/4" to 18" lateral adjustment
- Contoured back and seat cushions
- 32 oz. fire retardant vinyl
- Multi position folding back rest
- Hip restraints

▼ OEM Reference

HM MODEL1300	SY 1627	WS WM1208
SY 800048446	TC WM1208	
SY 800116971	TY 00591-21199-81	



Part Number - 380070-022

**Bucket Seat
Fold Back**

Part Number - 380070-022-E
Seat with Electric Switch

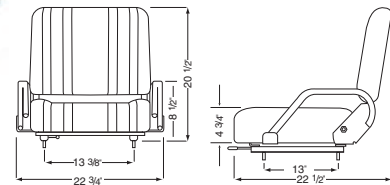

- Safety hip restraints
- Heavy steel frame with black powder coat finish
- 6" fore & aft adjusters 11" O/C mounting
- 11" & 13 3/8" lateral adjustment
- Contoured molded foam for optimum body support
- No-Sag spring construction
- 50 oz. heavy duty black vinyl

▼ OEM Reference

AC 3EB-50-A5890	KO 4901422	NI 87000-43K20
BK KM3EB-50-A5890	KO 4949484	NI 87000-60K01
CT A000026796	KO 4968103	NI 87600-91H55
ET 32107	KO 4969403	ST WM745
HM MODEL2200	KO 3306-6134E	SY 1866
HM MODEL2200-ELE	KO 3BB-50-A3120	SY 34430
HY 3125880	KO 3EB-50-A5860	TY 00591-07878-81
HY 3135726	KO 3EB-50-A5890	YT 150039574
IN 85-349	KO 3EB-50-A4910	YT 220027604
IN STWM-745	LP 753-7041	
KM 3EB-50-A5890	MB A000026796	



Part Number - 380070-016

**Suspension Seat (Vinyl)
Straight Back**

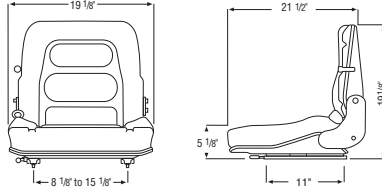

- Fore and aft adjustment 150mm in increments of 15mm
- Suspension stroke 40mm
- Weight adjustment 110-265 lbs. infinitely
- Angle adjustment of backrest infinitely 15°
- Specifically designed for a forklift which requires a low S.I.P.
- The fully integrated suspension within the backrest pan reduces harmful shocks for fatigue-free and safe operation
- The upholstery is of the vacuum formed and poured in-place type and can be easily exchanged for serviceability

▼ OEM Reference

BK 3244331000	JU 0760966	SL 524145
BK 3244331001	JU 0762781	ST 127266
BK 3244331002	JU 0763489	ST ST116073
BK 3244331005	JU 0763590	ST ST127266
BK 3244331010	JU 0763598	ST STSGRS12B1
BK 3244331011	JU 2760966	SY 800048466
BK 3244331032	JU 2763590	SY 800048479
BT 680396	JU 6132896	SY 800048480
CL 1400305	JU 14057390	SY 800048486
CL 2389314	JU 14388510	SY 800116985
CL 2793120	JU 27609660	SY 800124739
CL 3737932	JU 27627810	SY 1535
CL 3772793	JU 27632940	SY 1660
CL 3777118	JU 27634890	SY 1670
CL 3796400	JU 27635900	SY 1675
CL 3796460	JU 27635980	SY 1960
CL 4308663	JU 27636190	SY 1990
CL 4310868	JU 27636200	SY 35425
CL 4358426	JU 27637070	TA 90-160-70
CL 5456200	JU 50010821	TN 1056543
CL 6632388	JU 61260430	TY 00591-02129-81
ET 32001	JU 61263920	TY 00591-32845-81
GG 1129306	JU 61328960	TY 00591-34208-81
HM MODEL1600	JU 70051620	TY 00591-58460-81
HY 116073	LP 753-3003	TY 00591-58462-81
HY 226198	LP 753-7003	TY 53710-20720-71
HY 309702	MN 208521	TY 53730-20720-71
HY 322757	MN 409115	YT 150019501
HY 326480	MT 4207919651	YT 220071655
HY 335599	MT 4209717924	YT 220073083
HY 374171	NI 0255-49NNN	YT 220079977
HY 377906	NI 87000-03K00	YT 504226267
HY 823886	SL 300558	YT 504235296
HY 1345826	SL 521452	YT 505959514
HY 3069750	SL 522414	YT 751647603



Part Number - 380070-030

**Suspension Seat (Cloth)
Straight Back**

▼ OEM Reference

BK 3244331015	HY 3070641	SY SY1995
CL 1802151	IN 85-125	TN 34251
CL 1802446	LI 3244331015	TN 53845
CL 2775193	LP 753-3004	TY 00591-01114-81
CL 3736995	LP 753-7005	TY 00591-32847-81
CT A000028641	MB A000028641	TY 00591-34209-81
ET 32068	MH 3300489	TY 00591-58461-81
ET 32088	MN 454238	TY 00591-58463-81
ET 32145	SY SY1665	YT 150019503
HM MODEL3000	SY SY1965	YT 220072123



Part Number - 380070-023

**Contoured Pan Seat
Fold Back**

Part Number - 380070-023-E
Seat with Electric Switch

Switch P.N. 380030-182

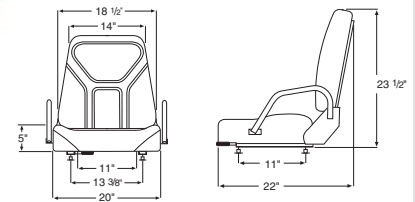

- Seat belt
- Adjustable back/hip restraint
- 6" fore & aft adjusters 11" O/C mounting
- 11" & 13 3/8" lateral mounting
- 14 gauge steel tubing
- 20" wide bottom seat cushion
- 18 1/2" tapered back cushion
- No-Sag spring construction
- 50 oz. heavy duty black vinyl
- Contoured molded foam for optimum body support
- Folding back rest with operator pouch

▼ OEM Reference

AC 8005-2116E	KO 3EA-50-A1150	KO H08005-2116
AC HO8005-2116E	KO 3EB-50-16110	KO HO3110-19
AF 00438	KO 3EB-50-A5160A	KO HO8002-2113
BK KMH08003-2113	KO 3EB-50-A5180	KO HO8003-2113
BK KMH08005-2116E	KO 3EB-50-A5181	KO HO8005-2116
HM MODEL2300	KO 3EB-50-A5181B	LI KM3EB-50-A5180
HM MODEL2300-ELE	KO 3EB-50-A5930	LI KM3EB-50-A5930
KO 3303-8116E	KO H03110-17	SY 1790
KO 3EA-50-A1120	KO H03110-19	TC WM1077



Part Number - 380070-026

**Contoured Back Seat
Fold Back**

Part Number - 380070-026-E
Seat with Electric Switch

- Seat belt
- 14 gauge stamped steel
- 2 piece molded cushion
- 67 mil. heavy duty vinyl
- Multi adjustment 11", 13" & 13 1/2"

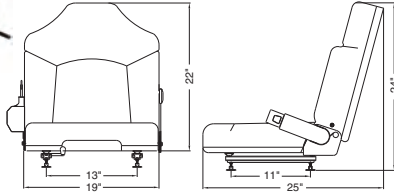

▼ OEM Reference

BK 147394	CL 926069	HM MODEL2600-ELE
BR 908830	CL 926072	LI 147394
BR 926069	CL 1636257	NI CK908830
BR CK2813105	CL 2389326	NI CK926069
CK 908830	CL 2389703	SY 800048420
CK 926069	CL 2795958	SY 1584
CL 908830	CL 2803280	YT 220170056
CL 908831	CL 2817183	
CL 915588	HM MODEL2600	



Part Number - 380070-032

**Molded Seat
Fold Back**

Part Number - 380070-032-E
Seat with Electric Switch

Switch P.N. 380030-182

- Retractable seat belt
- 14 gauge steel pan
- 2 piece molded cushion
- 67 mil. heavy duty vinyl
- Shoulder restraint
- Multi adjustment 11" & 13"

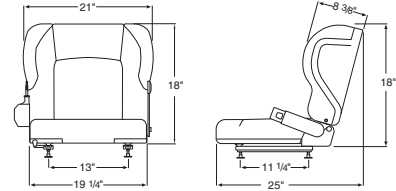

▼ OEM Reference

CL 448492	TY 53706-U2001-71	TY 53760-23000-71
CL 448494	TY 53706-U2100-71	TY 53760-23001-71
HM MODEL3200	TY 53730-U2100-71	TY 53760-23610-71
SY 1698	TY 53740-22750-71	TY 53760-U2100-71
TY 53706-U2000-71	TY 53740-23000-71	

▼ OEM Reference for Seat with Electric Switch Part No. 380070-032-E

HM MODEL3200-ELE	TY 53710-U1160-71	TY 53740-13300-71
SY 1695	TY 53720-U1090-71	
TY 53710-U1090-71	TY 53740-11590-71	



Part Number - 380070-029

**Contoured Seat
No Tilt or Fold Back**

- 67 mil. heavy duty vinyl
- Self-draining seat
- Seat belt mounting
- Contemporary styling
- Contoured for operator comfort
- 14 gauge stamped steel shell with black powder coat finish

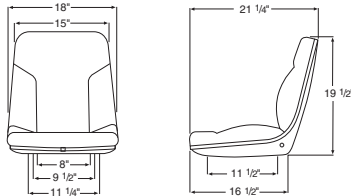

▼ OEM Reference

CT A000028830	SY 800048444	TC WM1268-1
HM MODEL2900	SY 1625	YT 504268740

Part Number - 380070-036-E

**Suspension Molded Seat with
Electric Switch**



- Adjustable backrest fore & aft ± 45 degrees
- Fore and aft slide-rail with adjustment of 150mm
- Retractable seat belt
- Mechanical suspension integrated in cushion
- Popular mounting size: side to side x front to back (228-230mm) x (280-290mm) or (328-330mm) x (280-290mm)

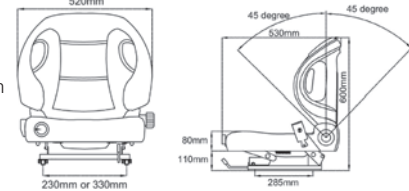

▼ OEM Reference

HM MODEL3600	TY 53710-88300-71	TY 53720-U2230-71
TY 53710-13131-71	TY 53710-88301-71	TY 53730-26701-71
TY 53710-23320-71	TY 53710-88302-71	TY 53780-U2101-71
TY 53710-23421-71	TY 53710-F2131-71	TY 53830-98333-71
TY 53710-23620-71	TY 53710-F2132-71	TY 53850-98334-71
TY 53710-26601-71	TY 53710-U2230-71	TY 53960-88300-71
TY 53710-26701-71	TY 53710-U2231-71	



Part Number - 380070-035

**Molded Seat
Fold Back**

Part Number - 380070-035-E

Seat with Electric Switch

Switch P.N. 380030-182

- Adjustable back angle 90° - 120°
- Adjustable lumbar with hip restraint
- 14¼" x 11" adjuster spacing
- Metal pan seat and back
- Vinyl pouch on back

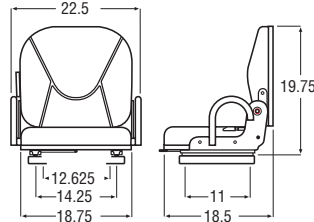

▼ OEM Reference

CT 93014-00010	HM MODEL3500-ELE	SY 1424
HM MODEL3500	MB 93014-00010	



Part Number - 380070-009

**Pan Seat
Straight Back**

Part Number - 380070-009-E

Seat with Electric Switch

Switch P.N. 380030-182

- 16 gauge steel black powder coat finish pan frame
- 6" fore & aft adjusters 11" O/C front to rear mount
- 4" to 11½" lateral adjustment
- 1.4 lb density foam pack with 55 lb. compression foam cushion
- 40 oz. fire retardant black madrid expanded vinyl

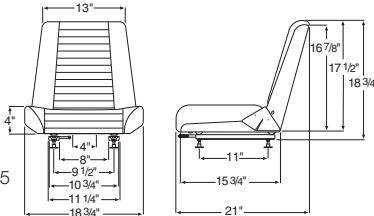

▼ OEM Reference

AF 00459	LP 753-3001	TY 00591-07880-81
BK 104056	LP WM127	TY 00591-30004-81
BR 87000-UMP00	MB ST973139	TY 00591-32844-81
CT 0973139	ME S4304-79-11	TY 00591-34205-81
HM MODEL900	ME S4304-79-2	TY 00591-58444-81
HM MODEL900-ELE	ME S4304-79-9	YT 150016901
HY 109983	NI 87000-UMP00	YT 150039250
HY 3021855	NI FLPRTPSP0006	YT 150039755
HY 3026746	NP 8231310	YT 514092400
HY 3031979	NP BK8231310	YT 518324400
HY 109983A	TC WM-127	YT 519678401
HY 112155A	TC WM682	
LJ 104056	TY 00591-07818-81	
LP 753-2003	TY 00591-07859-81	



Part Number - 380070-037-E

**Molded Seat with Electric
Switch**

Adjuster Knob (Front) P.N. 380030-133
Retr. Elec. Seat Belt P.N. 380082-060

OEM Seat P.N. 380070-037-EO

- NI 87000-FB400
- NI 87000-FW61B



- Retractable safety belt
- Fore and aft slide rail with adjustment of 150mm
- Document bag
- Electric switch
- Universal mounting pan covering:
Toyota: 330 x 285mm
TCM: 230 x 285mm
Mitsubishi: 320x275mm
Komatsu: 340 x 255mm
Nissan: 280 x 280mm

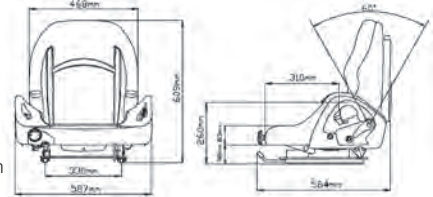

▼ OEM Reference

CT 91A14-01030	CT 91A14-31010	NI 87000-6G400
CT 91A14-11010	HM MODEL3700	NI 87000-FW50B
CT 91A14-21010	LP 753-2049	NI 87000-FW60A
CT 91A14-21030	NI 87000-6G210	YT 800037371



Part Number - 380070-012

**Pan Seat
Straight Back**

Part Number - 380070-012-E

Seat with Electric Switch

Switch P.N. 380030-182

- Swing up molded armrest
- 14 gauge steel black powder coat finish pan frame
- 6" fore & aft adjusters 11" O/C 4 1/4" front to rear mount
- 4" to 11¼" lateral adjustment
- 1.4 lb density foam pack with 55 lb. compression foam cushion
- 50 oz. fire retardant black madrid expanded vinyl

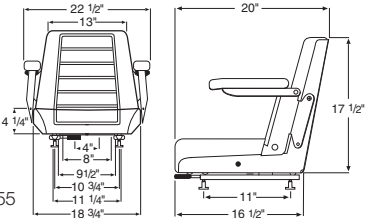

▼ OEM Reference

HM MODEL1200	SY 1848	TY 00591-07862-81
HM MODEL1200-ELE	TC WM684	WS WM684
SY 800116870		



Part Number - 380070-020

**Pan Seat With Tracks
Straight Back**

Part Number - 380070-020-E
Seat with Electric Switch

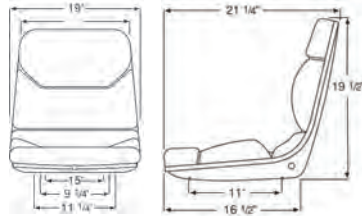

- 14 ga. steel tube frame with black powder-coat finish
- Heavy-duty vinyl
- Self-draining seat
- Seat belt mounting

▼ OEM Reference

CL 448114	HY 1603739	MB 91214-25400
CL 1802035	HY 1645425	MB 91314-08500
CT 1075199	HY 2087813	MB 91314-18400
CT 1097337	HY 275674	ST SA8604
CT 1129505	HY 377901	ST STV830
CT 1129507	HY 388515	ST STWM917A
CT 1223226	HM MODEL2000	SY 1867
CT 91214-09400	HM MODEL2000-ELE	TY 00591-07879-81
CT 91214-13400	IN SA8604	TY 00591-32834-81
CT 91214-15400	IN STV830	YT 150016910
CT 91214-19400	IN STWM917A	YT 220024381
CT 91214-25400	LP 753-3009	YT 220035307
CT 91314-18400	LP 753-7052	YT 504232239
CT 91314-08500	MB 1075199	YT 504285754
CT 971724	MB 1129505	YT 504305738
ET 32041	MB 1223226	YT 520042839
HY 0275674	MB 91214-09400	YT 524279699
HY 0377901	MB 91214-13400	YT 580057480
HY 1351431	MB 91214-15400	YT 580071141
HY 1525925	MB 91214-19400	YT 580071298



Part Number - 380070-027

**Molded Seat
Straight Back**

Part Number - 380070-027-E
Seat with Electric Switch

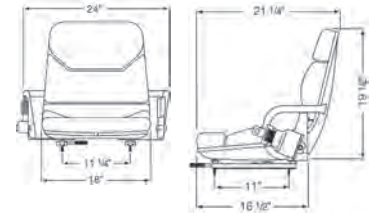

- One-piece drawn 14 ga. pan with black powder-coat finish
- Retractable seat belt and hip restraints
- Heavy-duty vinyl
- Self-draining seat
- Seat belt mounting

▼ OEM Reference

CL 448324	CT 6R7182	CT 91214-53900
CT 1029645	CT 91214-11300	HM MODEL2700
CT 1033164	CT 91214-21100	HM MODEL2700-ELE
CT 1037451	CT 91214-31100	MB 1029645
CT 1038589	CT 91214-31300	SY 800048442
CT 1049976	CT 91214-36300	SY SY1623
CT 1058285	CT 91214-41100	SY SY1771
CT 1097358	CT 91214-41300	
CT 6R7181	CT 91214-43900	



Part Number - 380070-041

Suspension Seat

▼ OEM Reference
HM MODEL4100

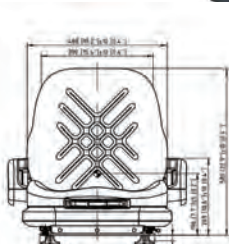

Part Number - 380070-100-E

**Molded Seat Fold Back
with Electric Switch**

▼ OEM Reference
HM 53720-U223171-OEM
TY 53720-U2231-71



Seats

Part Number - 380070-051-E

Suspension Molded Seat with Electric Switch



- Fore and aft slide-rail
- Adjustable backrest
- 2 point ELR safety belt
- Electric switch
- Weight adjustment
- Vinyl

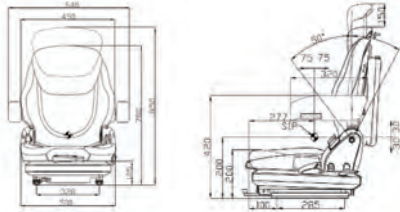

▼ OEM Reference

ET 32135	IN 85-433	SY 1550
HM MODEL5100	LP 753-7058	SY 1568
HY 3182955		

Part Number - 380070-053-E

Suspension Molded Seat with Electric Switch



- Fore and aft slide-rail
- Adjustable backrest
- 2 point ELR safety belt
- Electric switch
- Weight adjustment
- Cloth

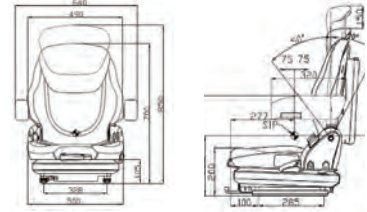

▼ OEM Reference

HM MODEL 5300	HY 4603383	YT 4603383
HY 2101603	HY 4603385	YT 4603385
HY 3032293	SY 1227023	YT 580086312
HY 3032295	TY 00591-21222-81	YT 582003583
HY 3182954	YT 150120096	

Now Available:



Power Switch Keys

See Electric Truck Components Section



Nitrile Grip Light Weight Gloves

See Service Supplies Section



BWT Grey Male Connector

See Battery and Charger Section



Seat Replacement Parts



Part Number - 380071-000
Seat Cushion - Bottom Vinyl

▼ OEM Reference
NI 87311-FB400



Part Number - 380070-038
Seat Cushion - Bottom Vinyl

▼ OEM Reference
BR 87320-FW80B
NI 87320-FW80B



Part Number - 380030-332
Seat Cushion - Bottom Vinyl

▼ OEM Reference
CT W505010682
CL 7005732
HY 1563207
MB W505010682
YT 580049883



Part Number - 370777
Seat Cushion - Bottom Cloth

▼ OEM Reference
YT 580095472



Part Number - 380073
Seat Cushion - Bottom Vinyl

▼ OEM Reference
HY 1703902

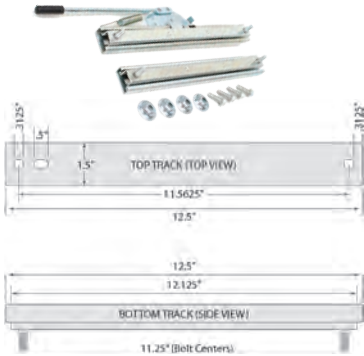

Part Number - 380030-265
Seat Tracks

▼ OEM Reference
HM WM-637-28
TC FA4846-82121
TC FC-WM637-28
TC 53723-U1090-71
TC 53724-U1090-71
TC 53735-U2100-71
TC 53736-U2100-71

For use with Toyota 6 Series



Part Number - 380030-264
Seat Tracks

▼ OEM Reference
HM WM-1250

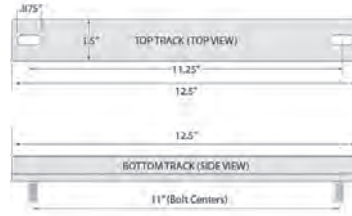

Part Number - 380030-182
Seat Switch

For use with Crown seats:
380070-009-E 380070-023-E
380070-012-E 380070-032-E
380070-015-E 380070-035-E



Part Number - 380030-321
Seat Switch - w/Harness, Non-Suspension

▼ OEM Reference
CT A0000-15661 HY 1367135 TY 00591-41919-81
CL 7004181 HY 3057555 TY 00591-57479-81
HY 1354140 MB A0000-15661 YT 518793606



Part Number - 380030-334
Seat Switch Operator Presence

▼ OEM Reference
HY 1563208
YT 580049884



Part Number - 380030-133
Adjuster Knob

▼ OEM Reference
HM KNOB-173
For use with
Crown 380070-037-E seat

Seat Belts

Lap Belts

Part Number	Description
380080-048	48" Black
380080-060	60" Black
380080-072	72" Orange
380080-074	74" Black
380080-110	110" Black



380080-048



380080-060, 380080-074,
380080-110



380080-072

Retractable Seat Belts

Part Number	Description
380081-060	60" Black
380081-060-O	60" Orange
380081-072	72" Black



380081-060



380081-060-O



380081-072

Retractable Electric Seat Belts - Open

Part Number	Description
370692	60" Orange
380082-060-E	60" Black
380082-060-OE	60" Orange
380082-072-E	72" Black



370692



380082-060-E



380082-060-OE



380082-072-E

Retractable Electric Seat Belts - Closed

Part Number	Description
380084-060-OE	60" Orange
380084-060-E	60" Black
380087	57" Black



380084-060-OE



380084-060-E



380087

Retractable Anti-Cinch Seat Belts

Part Number	Description
380083-060	60" Black
380083-060-O	60" Orange



380083-060



380083-060-O

Retractable Anti-Cinch Electric Seat Belts

Part Number	Description
380085-060-E	Open 60" Black
380082-060-E-NI	Open 60" Black - Nissan
380085-060-OE	Open 60" Orange
380086-060-E	Closed 60" Black



380085-060-E



380086-060-E

Notes:

Seat belts meet requirements of SAE J386 and FMVSS 302.

An open circuit, when wired, does not require the latch (male side) be inserted into the buckle in order to start the forklift. If wired to a buzzer or to an alarm, they will sound until the latch (male side) is inserted into the buckle or if wired to a dash lamp, the lamp will stay illuminated until the latch (male side) is inserted into the buckle. A closed circuit, when wired, requires that the latch (male side) be inserted into the buckle to complete the circuit in order to be able to start the forklift.

LPG Tanks

Steel Tanks



Part Number	Description	Water Capacity lb/kg	Propane Capacity gal/liter	Length/Height in/mm	Diameter in/mm	Tare Weight lb/kg
340012-005	20 lb. Steel Tank	47.6 / 21.6	4.6 / 17.4	19 / 483	12.2 / 310	27 / 12.2
340012-008	33.5 lb. Steel Tank	80 / 36.3	7.7 / 29.1	27.3 / 692	12.2 / 310	36 / 16.3
340012-010	43.5 lb. Steel Tank	104 / 47.2	9.9 / 37.5	33.3 / 845	12.2 / 310	44 / 20.0

Features: Quick coupler installed. Permanently positioned relief valve with clear path to the outside of the cylinder. For vertical or horizontal mounting applications. Footring designed to withstand high impact. Stackable. Made in the USA. Cylinder conforms with strict compliance to DOT specification 4BA240 and Transport Canada specification 4BAM16.

Aluminum Tanks



Part Number	Description	Water Capacity lb/kg	Propane Capacity gal/liter	Length/Height in/mm	Diameter in/mm	Tare Weight lb/kg
340013-005	20 lb. Aluminum Tank	47.6 / 21.6	4.6 / 17	20.4 / 518	12.3 / 312	17 / 7.7
340013-008	33.5 lb. Aluminum Tank	80 / 36.3	7.4 / 28	28.3 / 171.6	12.3 / 312	24 / 10.9
340013-010	43.5 lb. Aluminum Tank	104 / 47.2	9.9 / 37.5	33.9 / 862.1	12.3 / 312	25 / 11.3

Features: Quick coupler installed. Permanently positioned relief valve with clear path to the outside of the cylinder. For vertical or horizontal mounting applications. Footring designed to withstand high impact. Stackable. Aluminum cylinders are vacuum purged. Cylinders are shot blasted, resulting in a textured finish. Made in the USA. Cylinder conforms with strict compliance to DOT specification 4E240 and Transport Canada specification 4EM16.

Tank Replacement Parts

Part Number	Description
340065-001	Sight Gauge with Dial Chamber
340065-004	Service Valve (turns gas off to truck), 3/8" NPT, yellow cap included
340065-005	Fill Valve, 3/4" NPT X ACME



Quick Change Propane Valve

Part Number - 340409

Fits on any forklift and steel propane tank. Offers quick and easy installation.



Part Number - 380001-011-02

O-Ring Outer Flat 7141M3

▼ OEM Reference

AG 7141M3	PG 7141M3	TY 00591-31740-81
IN LPG-1066	RE 7141M-3R	TY 00591-51127-81
IN LPG-1073	TY 00591-31734-81	YT 064926500



Part Number - 137811

Clamp Toggle LP Tank

▼ OEM Reference
KO TB260



Part Number - 136232

Strap - LP Tank

12.16" diameter
2" width



Part Number - 064423

Connector LPG Female (OEM part)

▼ OEM Reference

KO 7141-F	HM 7141F	PG REGO7141F
AC 4738548	HY 0097999	RE 7141F
BK 101411	HY 97999	TY 00591-07632-81
BK 9Y11863	JL 2180387	TY 00591-11157-81
CL 655335	KO 7141F	TY 00591-31692-81
CL 715976	LP 225-6267	TY 00591-51083-81
CL 866176	MB 1015874	TY 23560-U2100-71
CL 926119	MB 93165-03600	TY 23560-U2101-71
CT 0045019	MB 93165-03800	WM 35A9482
CT 1015874	MB LM40AQ5019	WM 35P519
CT 45019	MB LM40AQ5019	YT 054966300
CT 9316503600	MB MDI700050	YT 136350102
CT 93165-03800	MB MIC0053011	YT 220014644
CT LM40AQ5019	MR E7141F	YT 220050482
CT MIC-0053011	NI 78001-7141F	YT 251102100
DW 045019	NI NF93165-03600	YT 505966505
DW D700178	PG 7141F	YT 912514300
GA 557-04	PG C-971-3	



Part Number - 380001-010-01

Connector LPG Male (OEM part)

▼ OEM Reference

KO 7141M	CT 9316503500	PG C-971-4
AC 4737405	CT MIC0053089	PG REGO7141M
BK 9Y11864	GA 557-03	RE 7141M
CL 6016-10470	HY 0124010	TC 7141M
CL 715977	HY 3051152	TY 00591-07633-81
CL 926118	MB 9136103501	TY 00591-31696-81
CT 0049099	MB 9136113500	TY 00591-51085-81
CT 1085332	MB 9300201300	WM 35A9481
CT 1085392	MB 9316503500	WM 35P517
CT 49099	MB MIC0053089	YT 054966400
CT 9136103500	NI 78001-7141M	YT 136350101
CT 9136103501	NI 7B001-7141N	YT 220050483
CT 9136113500	NI CK715977	YT 520035885
CT 9300201300	PG 7141M	
CT 9316503500		



Part Number - 380001-001-01
Lockoff VFF-30-2-IMP (OEM part)
 Replacement part:
 Repair Kit - P.N. 380001-004-01

▼ OEM Reference

AC 4870598	HY 258321	TC 53320-50401
AC 74870598	HY 287647	TY 00591-08206-81
AC 8641341	HY 3052453	TY 00591-31700-81
BK 105627	IMP VFF30-2	TY 00591-44714-81
CL 3675433	KO 34B-04-46310	TY 00591-51137-81
CL 6015-10340	MB 7N314	TY 23640-U2000-71
CL 923048	MB 91865-03100	YT 505966558
CT 7N314	MB C0053321	YT 904990600
CT 91865-03100	ME CHI70269-001	
CT 9326500070	NI 16245-VFF30	
HY 0258321	NI 16400-90H71	
HY 0287647	NI NF91865-13100	



Part Number - 380001-002-01
Converter JB-2 (OEM part)
 Replacement part:

▼ OEM Reference

CL 932437	IMP JB	KO JB
CL 2360140	IMP JB-2	YT 5170798-00



Part Number - 380001-018-01
Converter, GFI (OEM part)

▼ OEM Reference

HY 2056762	
HY 4602051	
YT 582001994	



Part Number - 380001-003-01
Converter Cobra (OEM part)
 Replacement part:
 Repair Kit - P.N. 380001-006-01

▼ OEM Reference

AC 74830760	CT 93465-10010	IMP 1085401
AC 74884393	DOS A218012	IMP 1085402
CL 923049	DW A218012	IMP COBRA
CL 932435	HY 1458025	NI 6016-10330
CT 91465-0020	HY 2023640	TC 53320-50501
CT 93165-03100	HY 2026468	TY 23530-22800-71
CT 93165-23100	HY 195193	YT 505959551
CT 93165-13100	HY 196193	YT 520002399
CT 93265-10060	HY 213549	YT 520037830
CT 93265-10080	HY 3004951	YT 580002388
CT 93265-20800	HY 3052059	YT 580002399
CT 93265-30800	IMP 1040397	



Part Number - 380001-007-01
Repair Kit CA100/CA125 (OEM part)

▼ OEM Reference

AC 4906962	JU 141150106	TY 00591-05456-81
BK 3155729000	JU 14348300	TY 00591-14729-81
CL 4339780	JU 14348310	TY 00591-31729-81
CL 448383	JU 14348320	TY 00591-31741-81
CL 998838	LI 9810306	TY 00591-51156-81
CT 91865-06400	LI D3155729000	YT 220079907
DW 7W5191	MB 7W5191	YT 505963504
DW D700725	MB A0000-00355	YT 505963589
HY 204782	MB LM4AHN9223	YT 516987805
HY 1358246	NI CK998838	YT 520045894
HY 1358247	PG AV1-14-1	YT 900971806
HY 3052003	PG AV1-14-4	YT 900971809
HY 3069660	PG N00-7426A	YT 900971837
IMP AV1-14-4	TC 52050-59871	YT 902249814
JU 14115000	TC DET000997	
JU 14115010	TY 00591-04117-81	



Part Number - 380001-004-01
Repair Kit VFF30-2 (380001-001-01) (OEM part)

▼ OEM Reference

KO RK-VFF30-2



Part Number - 380001-005-01
Repair Kit JB2 (380001-002-01) (OEM part)

▼ OEM Reference

BK 1055931	MB MIC-00531001	TY 00591-64562-81
HY 30049581	MB MIC-00531101	TY 04255-U201171
IMP RKJ	MB MDI-7002101	YT 5170808001
MB 93165-031101	TY 00591-14708-81	YT 9009698231
MB MDI-7002101	TY 00591-44723-81	



Part Number - 380001-006-01
Repair Kit Cobra (380001-003-01) (OEM part)

▼ OEM Reference

CL 920165	HY 2026467	TY 00591-14608-81
CL 923292	HY 2026721	TY 00591-14711-81
CL 932698	IMP RK-COBRA	YT 518807650
CT 93165-13110	IMP RK-K	YT 580007732
DW A213955	IMP RK-K-2	YT 902057822
HY 1375031	IMP N00-6314A	YT 902057825
HY 1459717	JU 14518910	YT 902057827
HY 2023646	MB 93165-13110	YT 924088300
HY 2023647	NI NF93165-13110	



Part Number - 380001-040-01
Repair Kit (IMPCO)

▼ OEM Reference
IMP RK-EPR-3-IMP



Part Number - 380001-042-02
Regulator
• N-2007

▼ OEM Reference
CL 5233-1018
DW A403937



Part Number - 380001-008-01
Regulator LPG (OEM part)
• 30N10 Tag #
• UL-LP, UL-LPS, UL-G/LP, LPG UK

▼ OEM Reference
TY 23530-U1100-71
TY 23530-U1101-71
TY 23530-U1102-71
TY 23530-U1103-71
TY 23530-U1104-71



Part Number - 380001-029-02
Regulator Assembly LPG (Aisan)
• 30B80 Tag #

▼ OEM Reference
TY 23550-U2170-71



Part Number - 380001-017
Regulator (Aisan)
• 30M40 Tag #

▼ OEM Reference
TY 23510-U2230-71
TY 23530-U2230-71



Part Number - 380001-031
Regulator E Controls

▼ OEM Reference
CL 1242402 HY 76500689 YT 582037121
CT 93721-04300 MB 93721-04300 YT 76500689
HY 4019119 TY 23550-U3330-71
HY 4097623 YT 582007576



Part Number - 380001-019
Regulator (Aisan)
• 30M60 Tag #

▼ OEM Reference
TY 23540-U2230-71
TY 23560-U2230-71



Part Number - 380001-012-01
Vaporizer K21-K25 (OEM part)
Repair Kit - P.N. 380030-069

▼ OEM Reference
AC VAP-FT860 KO 16310-GY960 NI 16310-FT860
CT 91A65-00400 KO 16310-GY96D NI 16310-FT860A
CT 91A65-00401 KO 8772296 NI 16310-FT86D
CT 91A65-00402 KO VAP-FT860 NI 16310-FU461
CT 91H20-00400 MB 91A65-00400 NI 16310-FU46C
CT 93A65-00400 MB 91A65-00401 NI 16310-GS04A
CT 93A65-10400 MB 91A65-00402 NI 16310-GS04B
CT 93A65-20400 MB 91H20-00400 NI 16310-GS04C
CT A0000-32540 MB 93A65-00400 NI 16310-GY960
KO 16310-FT860 MB 93A65-10400 NI 16310-GY96C
KO 16310-FT860A MB 93A65-20400 NI 16310-GY96D
KO 16310-FT86D MB A0000-32540



Part Number - 380001-020
Regulator (Aisan)
• 30M50 Tag #

▼ OEM Reference
TY 23550-U2230-71
TY 23570-U2230-71



Part Number - 380001-028-02
Regulator (Aisan)
• 30S50 Tag #

▼ OEM Reference
TY 23530-U2201-71



Part Number - 380001-015-01
Vaporizer Nikki (OEM part)

Repair Kit - P.N. 380030-069

▼ OEM Reference
AC AC8772296 NI 16310-GS00A NI 16310-GY36B
CT 91A65-01601 NI 16310-GS00C NI 16310-GZ560
CT 91A65-21600 NI 16310-GY361 TC 547C0-52001



Part Number - 380001-021
Regulator (Aisan)
• 30P30 Tag #

▼ OEM Reference
HY 1594144
YT 5800604-05
YT 580060405

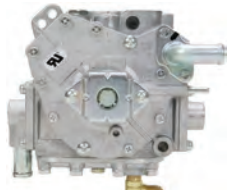

Part Number - 380001-013-01

**Vaporizer
K21-K25 (OEM part)**

Repair Kit - P.N. 380030-069

▼ OEM Reference

HAM 8777431	HAM 16310-GS40A	NI 16310-GS40A
HAM 8779362	HAM 16310-GU20A	NI 16310-GU20A



Part Number - 380001-023

**Vaporizer
Nikki (OEM part)**

▼ OEM Reference

NI 16310-GS40B
NI 16310-GS40C



Part Number - 380030-319

Body - Throttle 4Y

▼ OEM Reference

TY 22030-78640-71
TY 22030-UB010-71



Part Number - 380030-069

**Repair Kit
K21-K25 (OEM part)**

For 380001-012-01, 380001-013-01 & 380001-015-01 vaporizers

▼ OEM Reference

CT 90425-08490	KO 16328-GY010	NI 16328-GY010
CT 91965-07500	NI 16328-GS00A	



Part Number - 380001-016

Repair Kit

For 380001-012-01, 380001-013-01 & 380001-015-01 vaporizers

▼ OEM Reference

NI 16310-RPKIT



Part Number - 380001-041-01

Secondary Diaphragm

▼ OEM Reference

IMP RK-EPR-5-IMP



Part Number - 380030-132

Diaphragm Kit

▼ OEM Reference

TY 04221-U2010-71



Part Number - 380101-477

Diaphragm Kit (Aisan)

▼ OEM Reference

CL 448689	HY 1479531	TY 04221-U1102-71
CL 7005029	TY 04221-20400-71	TY 04221-U1103-71
CT A0000-14995	TY 04221-20401-71	TY 04221-U1104-71
CT A0000-16040	TY 04221-U1100-71	YT 580017217
CT A0000-18901	TY 04221-U1101-71	



Part Number - 380030-060

Diaphragm Kit (Nikki)

▼ OEM Reference

CT 91H20-14470
KO 17960-VR500
NI 17960-VR500



Part Number - 380030-111

Diaphragm Kit (Nikki)

▼ OEM Reference

CT 91H20-04380
HM 17053-FU460
KO 17053-FU460
NI 17053-FU460



Part Number - 380001-027

Plate - Input

▼ OEM Reference

KO 30B-13-11120



Part Number - 380001-024

Filter

▼ OEM Reference

HY 2070100	YT 580051579
HY 800138303	YT 580090374



Part Number - 380030-188

Injector

▼ OEM Reference

HY 1620009
YT 524248301



Part Number - 380030-272

Injector

▼ OEM Reference

TY 23260-76001-71

Fuel/LPG



Part Number - 380030-073

Injector

▼ OEM Reference

AC	16600-GS17B	KO	A6600-FU471	MB	91H20-16690
CT	90425-08560	KO	A6600-FU571	MB	91H20-16690
CT	90425-18040	KO	16600-GS17B	MB	16600-GS07B
CT	91H20-06690	KO	8779367	NI	A6600-FU471
CT	91H20-15230	KO	16600-GS07A	NI	A6600-FU571
CT	91H20-16690	KO	16600-GS07B	NI	16600-GS17B
HAM	A6600-FU471	MB	90425-08560	TC	A6600-FU471
HAM	A6600-FU571	MB	90425-18040	TC	A6600-FU571
HM	16600-GS07C	MB	91H20-15230		



Part Number - 380030-152

Fuel Pressure Sensor

▼ OEM Reference
 CT 90425-18080
 NI 16638-GX11A



Part Number - 380030-214

Valve Assembly

▼ OEM Reference
 CT 91A65-00600
 MB 91A65-00600
 NI 17904-FC300



Part Number - 380051-007

LPG Switch

▼ OEM Reference
 NI 17908-FC00D



Part Number - 380030-297

Element Kit - LPG Filter (Asian)

▼ OEM Reference
 TY 04236-U2020-71

Note: Filter in this kit is PN 380030-292.

Part Number - 380030-292

Element - Filter (Asian)

▼ OEM Reference
 HY 3004371
 HY 3040365
 TY 23644-26600-71
 TY 23644-U2170-71

Note: This filter is included in kit 380030-297.



Part Number - 380104-927

Fuel Pressure Sensor

▼ OEM Reference

AC	8772247	KO	16197-FU46A
AC	8777427	KO	16197-FU461
CT	90425-18250	NI	16197-FU46A
KM	8772247		

InfoLink It's time to make the most of your connections.

- Conduct formal review of data inputs and the value generated to date
- Develop action steps to promote positive change
- Adjust best practices and system settings as needed

Business Review - ABC Company Select Month: December | Select Location: Location 1 | InfoLink

📍	1 Location	🚛	242 Trucks	👥	42 Users Logged In
📄	2,788 Total Licenses	📋	4,621 Total Pre-shift Inspections	🌟	70 Total High Impacts
📵	0 Trucks Not Communicating	📅	87 Licenses Expiring in Next 90 Days	📱	65 QPR Trucks

This is one of many customized reports that is available through Crown's InfoLink Services.

Part Number - 380005-003-01

**Starter F2, FE & VA
(OEM part)**

Teeth (8)



▼ OEM Reference

HY 1534424 YT 580040914
HY 2314322 YT 918139600

Part Number - 380005-002-01

**Starter 4P, 4Y, 5P, 5R,
GM 4 Cyl & GM 6 Cyl
(OEM part)**

Teeth (9)



▼ OEM Reference

TC 212T1-07201 TY 28300-22003
TY 28100-20553-71 TY 90928-29006-71
TY 28100-20553

Part Number - 380005-011-02

Starter F2, FE & VA

Teeth (8)



▼ OEM Reference

HY 1534424-NEW YT 580040914-NEW
HY 2314322-NEW YT 918139600-NEW
TC TFFSC18400-NEW

Part Number - 380005-019-01

Starter 4P, 4Y, 5P & 5R

Teeth (9)



▼ OEM Reference

TY 28100-36770-71



Part Number - 380005-017-01

**Starter F2, FE & VA
(OEM part)**

Teeth (8)

▼ OEM Reference

HY 1362069
TC TFESE18400
YT 900540857
YT 912978600

Part Number - 380105-187

Starter 4Y, 12 Volt

Teeth (9)



▼ OEM Reference

TC 212T1-07201-N TY 28300-22003-71N
TY 28100-20553-71N TY 90928-29006-71N

Part Number - 380105-167

Starter GM 4.3L

Teeth (10)



▼ OEM Reference

HY 1383240-NEW
YT 580006456-NEW

Part Number - 380105-174

Starter GM 4.3L

Teeth (11)



▼ OEM Reference

CL 933606-NEW DW A232158-NEW YT 580074751-NEW
CT 91920-04400 HY 1640531-NEW
CT 91920-14400 MB 91920-14400

Part Number - 380005-005-02

Starter GM 3.0L
Teeth (11)



▼ OEM Reference

CL 2817056	HY 1391321	SB 8156144
CL 925874	HY 1457047	YT 220044332
CL 930707	HY 1486530	YT 580000049
CL 933605	HY 1650426	YT 580002210
CT A0000-05846	JU 50018782	YT 580019725
HY 1374621	JU 50137926	YT 580077957

Part Number - 380005-004-01

Starter 4G63 & 4G64 (OEM part)
Teeth (10)



▼ OEM Reference

CL 920971	DW A218315	MD 320618
CT MD320618	MB MD320618	NI MD320618

Part Number - 380005-009-02

Starter GM 2.4L
Teeth (9)



▼ OEM Reference

HY 1548620	HY 80-1406	HY 9000890
HY 300-1555	HY 800136352	YT 580044885

Part Number - 380005-008-02

Starter K21 & K25 (OEM part)
Teeth (9)



▼ OEM Reference

AC 8772272	KO 23300-FU410	MB 91H20-03330
CT 91H20-03330	KO 23300-GS20A	NI 23300-FU410
CT 91H20-06190	KO 23300-GS20C	TC N-23300-FU410

Part Number - 380005-018-01

Starter 4G32, 4G33, 4G52 & 4G54
Teeth (8)



▼ OEM Reference

CL 909329	CT MM115517	MB MD189054
CL 3790819	KO 4920209	MB MM115514
CT MM115514	MB 909329	MB MM115517
CT MD189054		

Part Number - 380005-001-01

Starter H20, H20II & H25 (OEM part)
Teeth (9)



▼ OEM Reference

AC 4967525	NI 23300-K9160
KO 23300-K9160	TC 23300-K9160

Part Number - 380005-015-01

Starter K21 & K25
Teeth (9)



▼ OEM Reference

AC 8772272	KO 23300-FU410	MB 91H20-06190
CT 91H20-03330	KO 23300-GS20A	NI 23300-GS20A-N
CT 91H20-06190-NEW	KO 23300-GS20C	
KM 8772272-NEW	MB 91H20-03330	

Starters

Part Number - 380005-006-01

Starter A15, H20 & J15 (OEM part)

Teeth (8)



▼ OEM Reference

AC 4942421	MB M3T21882D	NI 23300-L2911
AC 4948522	NI 23300-00H10	NI 23300-L2912
KO 23300-00H10	NI 23300-00H11	TC 23300-00H10
KO 23300-00H11	NI 23300-L2910	

Part Number - 380005-012-02

Starter Yanmar 2.6L & 3.3L Diesel

Teeth (9)



▼ OEM Reference

CL 8023898	KO YM129900-77010N
HY 1599845-NEW	YT 580062748-NEW
KM 8762412-NEW	

Part Number - 380005-013-02

Starter TB42

Teeth (9)



▼ OEM Reference

CT 90425-02580-N	NI 23300-52H00-N
KM 4968855-NEW	

Part Number - 380005-014-02

Starter C240 Diesel

Teeth (9)



▼ OEM Reference

HY 1519632-NEW
HY 1519632

Part Number - 380105-204

Starter White 1404

Teeth (10)



▼ OEM Reference

CL 930031-NEW	DW A213980-NEW	MB 6T7004-NEW
DW A213980	DW D141291	

Starter Replacement Parts



Part Number - 380005-050

Starter Drive

▼ OEM Reference

HY 2314328
TC TB63018X45
YT 9023618-06



Part Number - 380005-051

Starter Solenoid

▼ OEM Reference

HM 520	HY 2314342	YT 901286817
HM 555	TC T-4894-24-760	YT 901991817
HY 1368862	TC TFESE18X10	YT 902361820
HY 1574092	YT 580053798	



Part Number - 380006-001-02
Water Pump H20 New Style

▼ OEM Reference

AC 4942349	KO 21010-L1125	NI 21010-L1128
AC 4969885	KO 21010-L1126	TC 21010-20H25
CL 7000507	KO 21010-L1128	TC 21010-78226
CT 0971264	KO 64-101	TC N-21010-L1100
CT 971264	NI 21010-20H25	TC N-21010-L1125
HY 3041677	NI 21010-78226	TC N-21010-L1126
HY 3045360	NI 21010-L1100	TY 00591-07978-81
KO 21010-78226	NI 21010-L1101	TY 00591-32887-81
KO 21010-L1100	NI 21010-L1125	TY 00591-50484-81
KO 21010-L1101	NI 21010-L1126	YT 220007606



Part Number - 380106-057
Water Pump F2

▼ OEM Reference

AC 64-702	HY 865434	TY 00591-34280-81
CT 14411860	JU 14411860	TY 00591-54103-81
CT A0000-02548	KO 64-702	YT 150118724
HY 0865434	LP 126-9039	YT 220019096
HY 1582588	MB 14411860	YT 524242078
HY 2028644	MB A0000-02548	YT 901579801
HY 2078488	TC T-8AK1-15-010	
HY 3122609	TY 00591-11107-81	



Part Number - 380006-002-02
Water Pump K21 & K25

Includes 8 fins; the impeller is flush with the housing

▼ OEM Reference

AC 8761949	KO 21010-FU40J	NI 21010-FU425
CT 91H20-02580	NI 21010-FU40J	YT 220024192
DW D490720	NI 21010-FU400	



Part Number - 380006-005-02
Water Pump 4G63 & 4G64

▼ OEM Reference

AC 8772259	DW A218276
CL 1232510	KO 8772259
CT 1041579	MB MD970338
CT MD970338	MB MD972457
CT MD972457	



Part Number - 380006-003-02
Water Pump HER2.7 & 1404

▼ OEM Reference

AC 4948821	DW 2W8554	KO HE40-2035079
CT 1W0404	DW 4W1583	MB 9Y5969
CT 1W404	DW 9Y5969	MB D700615
CT 4W1583	DW D700615	MB MCF00036
CT 9Y5969	HY 402035079	NI D700615
CT D700615	KO HE40-2035063	TY 00591-05705-81
CT MCF00036	KO HE40-2035078	YT 220007160



Part Number - 380006-006-02
Water Pump GM 3.0L

▼ OEM Reference

CL 924942
DW A218653
HY 388365
TY 16100-U2120-71



Part Number - 380006-007-02
Water Pump 4Y 5 & 6 Engines

▼ OEM Reference

CL 446097	TY 00591-32889-81	TY 16120-96151-71
HY 3046758	TY 00591-53193-81	YT 220010746
TY 00591-10723-81	TY 16120-78151-71	



Part Number - 380006-004-02
Water Pump FE

▼ OEM Reference

CL 7000511	JU 14520447	YT 220079608
HY 1361811	MZ FE7915010C	YT 5059605-79
HY 2022312	TY 00591-22426-81	YT 901302802
JU 14365400	TY 00591-32891-81	
JU 14365450	TY 00591-61180-81	



Part Number - 380006-009-02
Water Pump VA

▼ OEM Reference

CT 219273	HY 326774	TY 00591-54109-81
HY 1339931	HY 326779	YT 220007409
HY 1376005	TY 00591-34296-81	
HY 3002535		



Part Number - 380006-010-02
Water Pump 4Y 7 Series

▼ OEM Reference

TC 212T1-09451
TY 16110-78156-71

Note: All water pumps include gasket.

Pumps



Part Number - 380006-011-02

Water Pump H20II & H25

Includes 6 fins; the impeller is raised out from the housing

▼ OEM Reference

CT A0000-00429	KO 21010-50K29	TC N-21010-50K26
HY 3132592	KO 21010-FF225	TC N-21010-50K28
HY 3142317	KO 21010-P7526	TY 00591-21011-81
KO 21010-50K01	KO 64-102	TY 00591-34284-81
KO 21010-50K02	KO 8772259	TY 00591-54104-81
KO 21010-50K26	LP 126-9040	YT 220043217
KO 21010-50K28	LP 126-9087	



Part Number - 380006-016-01

Orbitrol Steering Gear Pump

▼ OEM Reference

CT 93E54-00200	NI 49410-6G000	NI 49410-91H01
MB 93E54-00200	NI 49410-6G401	



Part Number - 380006-017-01

Orbitrol Steering Gear Pump

▼ OEM Reference

CT 91B54-00200	NI 49410-FC300	NI 49410-FJ500
MB 91B54-00200	NI 49410-FJ100	NI 49410-FK000
NI 49410-FC300		



Part Number - 380006-012-01

Hydraulic Pump (Lift)

▼ OEM Reference

RA 1032206



Part Number - 380006-014-01

Hydraulic Pump

▼ OEM Reference

HN 31FN-01000



Part Number - 380006-015-01

Hydraulic Pump

▼ OEM Reference

KO 37B-1KA-5021
KO 37B-1KA-A712
KO 37B-1KC-5022



Part Number - 380006-018-01

Orbitrol Steering Gear Pump

▼ OEM Reference

HY 2056868	YT 580037271
YT 580037270	YT 580043152



Part Number - 380006-019-01

Orbitrol Steering Gear Pump

▼ OEM Reference

RA 1008426



Part Number - 380006-020-01

Orbitrol Steering Gear Pump

▼ OEM Reference

TC 15604-10202
TC HC32G4-10101

Note: All water pumps include gasket.

Pump Parts



Part Number - 380006-021

Water Pump Gasket

▼ OEM Reference

TY 16124-78156-71



Part Number - 380030-309

Water Pump Kit - Cover

▼ OEM Reference

TY 90904-U9002-71



Part Number - 380006-022

Water Pump Gasket

▼ OEM Reference

YT 901579805

Note: For use with Mazda / 2.2 Engine

Alternator Plug Reference Diagram

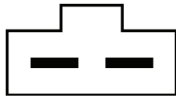

Plug E



Plug G

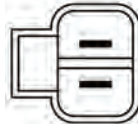

Plug H

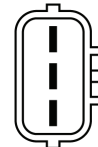

Plug J



Plug K

Part Number - 380011-004-02

Alternator A15, D5, FE, F2, H20, P40, TB42, 4FE1 Diesel & S4S Diesel, 12 Volt, 35 Amp

■ Plug G



▼ OEM Reference

AC 4949046	HA LT135-68	NI 23100-A5502
BO 986032431	HA LT135-69	NI 23100-B8001
BO 986033481	HA LT150-25	NI 23100-B8002
CL 7000289	HA LT150-25B	NI 23100-B9802
CT A0000-02071	HC LT135-68	NI 23100-B9810
FL 2475677210	HY 1310962	NI 23100-B9810-B
HA LT125-04	HY 3020078	NI 23100-E5200
HA LT125-06B	KO 23100-B9810	NI 23100-H0100
HA LT130-41K	MB A1T20271	NI 23100-H0110
HA LT130-65	MB A1T21171	NI 23100-H0300
HA LT130-72	MB A1T22581	NI 23100-H0310
HA LT130-72B	MB A1T24371	NI 23100-M0400
HA LT130-75	MB AG2025A	NI 23100-M0401
HA LT135-13	MB AG2030A	NI 23100-M0402
HA LT135-13B	MB AG2035A	NI 23100-M0410
HA LT135-17B	MB AG2035A2	NI 23100-U0101
HA LT135-19B	MB AG2035N1	NI 23100-U0111
HA LT135-19C	MB AH2035N1	TC 53032-72601
HA LT135-19E	MZ GE01-18-300	TC N-23100-B9810
HA LT135-20	NI 23100-06000	TC N-23300-B9810
HA LT135-24	NI 23100-A4602	TY 00591-33739-81
HA LT135-35	NI 23100-A4800	TY 00591-55972-81
HA LT135-35B	NI 23100-A4810	YT 150014500
HA LT135-35C	NI 23100-A5500	YT 150022504
HA LT135-54	NI 23100-A5501	YT 901285801

Part Number - 380011-001-01

Alternator H20 II, H25, TB42 (OEM part), 12 Volt, 35 Amp

■ Plug H

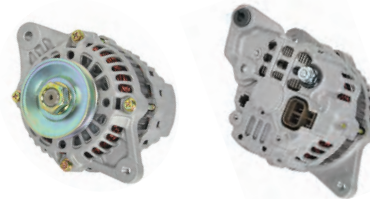

▼ OEM Reference

AC 8762055	KO 8762055	NI 23100-87V10
AC 8775058	KO 8775058	
CT 90425-02410	MB 90425-02410	

Part Number - 380011-007-02

Alternator H20 12 Volt, 35 Amp

■ Plug G



▼ OEM Reference

AC 4942402	NI 23100-H7703	NI 23100-U0114
AC 4947935	NI 23100-M0413	NI 23100-U4601
CT 971562	NI 23100-M0414	TC 23100-M0413
KO 23100-C6000	NI 23100-M6601	TC 23100-U0103
KO 23100-M0413	NI 23100-U0100	TC N-23100-C6000
KO 23100-M0414	NI 23100-U0102	TC N-23100-M0413
KO 23100-U0105	NI 23100-U0103	TC N-23100-M0414
NI 23100-A4600	NI 23100-U0104	TC N-23100-U0100
NI 23100-A4601	NI 23100-U0105	TC N-23100-U0102
NI 23100-A4611	NI 23100-U0110	TC N-23100-U0103
NI 23100-C6000	NI 23100-U0112	TY 00591-08089-81
NI 23100-H6215	NI 23100-U0113	

Part Number - 380011-013-02

Alternator H20II, H25 & TB42 12 Volt, 50 Amps

■ Plug H



▼ OEM Reference

AC 23100-50K15	HY 1720588	MB A007T-03771
AC 23100-FU410	HY 76000743	MB A007T-A3377
AC 8772271	KO 23100-50K15	NI 23100-50K15
CT 50460080	KO 23100-FU410A	NI 23100-FF110
CT 91H20-03270	KO 8772271	NI 23100-FU410
CT A0000-14162	MB 50460080	NI 23100-FU41A
CT A007T-03771	MB 91H20-03270	YT 76000743
CT A007T-A3377	MB A0000-14162	

Part Number - 380011-006-02

Alternator GM & Waukesha 12 Volt, 63 Amp

■ Plug E



▼ OEM Reference

AC 4789142	CL 908106	PL 8AR2200L
CL 2363677	CL 908221	SG 2383064
CL 2383064	CT 213346	TY 00591-21035-81
CL 2399509	HY 3029189	TY 00591-27362-81
CL 2399511	HY 3046654	TY 00591-33616-81
CL 6513962	HY 385656	YT 220005010
CL 6599739	JU 1470500	
CL 905949	JU 14705000	
CL 907739	PL 110-460	

Part Number - 380011-002-01

Alternator 4Y (OEM part)
12 Volt, 35 Amp
 ■ Plug K



▼ OEM Reference

KO TJ27060-78003-71	TC 212T1-06941	TY 27060-78003-71
KO TJ270607800371	TY 00591-10795-81	TY 27060-78155-71
ND 100211-4540	TY 00591-50056-81	YT 220042179

Part Number - 380011-010-01

Alternator 4G52 & 4G54 (OEM part)
12 Volt, 45 Amp
 ■ Plug G

Alternator 4G33 (OEM part)
12 Volt, 45 Amp
 ■ Plug G



▼ OEM Reference
 CL 3768011

▼ OEM Reference
 CT MD034130
 MB MD034130

Part Number - 380011-011-01

Alternator 4G52 & 4G54 (OEM part)
12 Volt, 50 Amp
 ■ Plug G



▼ OEM Reference

CL 3768023	KM 4921289
CT MD064068	MB MD064068

Part Number - 380011-003-02

Alternator 4Y (OEM part)
12 Volt, 50 Amp
 ■ Plug J



▼ OEM Reference

TY 27060-78153-71
TY 27060-78156-71
TY 27060-78158-71
TY 27060-UB030-71-HD
TY 27060-UB050-71

Part Number - 380106-621

Alternator 4Y
12 Volt, 50 Amp
 ■ Plug J



▼ OEM Reference

TY 27060-78158-71N
TY 27060-78160-71
TY 27060-UB030-NEW

Part Number - 380011-008-01

Alternator (OEM part)
12 Volt, 40 Amp
 ■ Plug Not Applicable

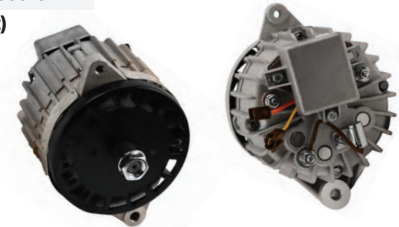

▼ OEM Reference

HY 1394001
YT 580073364
YT 900017264

⚠ **WARNING:** Cancer and reproductive harm - www.P65Warnings.ca.gov

Part Number - 380011-009-01

Alternator 4G64 & 4G63 (OEM part)
12 Volt, 50 Amp
 ■ Plug H



▼ OEM Reference

CL 920244	DW D187478
CL 928179	MB MD354809
CT MD354809	

Part Number - 380100-117

Alternator
12 Volt, 35 Amp
 ■ Plug H



▼ OEM Reference

AC 8762055	KO 8762055	NI 23100-87V10-N
AC 8775058	KO 8775058	
CT 90425-02410-N	MB 90425-02410-N	

Alternators

Part Number - 380011-005-01

Alternator FE (OEM part)
12 Volt, 40 Amp
■ Plug G



▼ OEM Reference

HY 1361853 HY 1450928-HD YT 580000990

Part Number - 380011-012-02

Alternator FE
12 Volt, 40 Amp
■ Plug G



▼ OEM Reference

HY 1361853R YT 150012758 YT 901948801
HY 1450928 YT 505960560
JU 14485060 YT 580000990

Radiators and Accessories

Continued ▶



Part Number - 380009-001-02

Radiator

▼ OEM Reference
AC 8761212
KO 3EB-04-A5111

Replacement Cap: 380009-104



Part Number - 380009-007-02

Radiator K21-K25

▼ OEM Reference
KO 3EB-04-A6110

Replacement Cap: 380009-104



Part Number - 380009-003-02

Radiator

▼ OEM Reference
NI 21460-90H15
NI 21460-90H15-D

Replacement Cap: 380009-104



Part Number - 380009-008-02

Radiator

▼ OEM Reference
KO 3EA-04-51110

Replacement Cap: 380009-104
90° Fitting: 3EB-04-48110



Part Number - 380009-004-02

Radiator

▼ OEM Reference
NI 21460-6G000
NI 21460-6G100
NI 21460-6G101
NI 21460-G6000

Replacement Cap: 380009-104



Part Number - 380009-009-01

Radiator (OEM part)

▼ OEM Reference
TY 16410-F1100-71
TY 16410-U2200-71
TY 16410-U2201-71
TY 16420-U1250-71
TY 16420-U1280-71

Replacement Cap: 380104-494



Part Number - 380009-005-02

Radiator

▼ OEM Reference
CT A0000-12933
TY 16410-23010-71
TY 16410-23070-71
TY 16410-U2000-71

Replacement Cap: 380009-104



Part Number - 380009-110-02

Radiator

▼ OEM Reference
TY 16410-U1130-71

Replacement Cap: 380009-104



Part Number - 380009-006-02

Radiator

▼ OEM Reference
NI 21460-24H10
NI 21460-90H10

Replacement Cap: 380009-104



Part Number - 380009-111-01

Radiator (OEM part)

▼ OEM Reference
HY 4603553 YT 580057495
YT 580044218 YT 582003828

Replacement Cap: 380009-102



Part Number - 380009-112-01

**Radiator
(OEM part)**

▼ OEM Reference
FC 290-1293
HY 2056870
LP 290-1293

Replacement Cap: 380009-102



Part Number - 380009-122-01

**Radiator
(OEM part)**

▼ OEM Reference
HY 4603554
YT 582003829

Replacement Cap: 380009-102



Part Number - 380009-114-01

**Radiator
(OEM part)**

▼ OEM Reference
TY 16410-U2130-71

Replacement Cap: 380009-104



Part Number - 380009-123-01

**Radiator
(OEM part)**

▼ OEM Reference
HY 2054879
YT 580035647

Replacement Cap: 380009-102



Part Number - 380009-116-01

**Radiator
(OEM part)**

▼ OEM Reference
HY 2060012

Replacement Cap: 380009-102



Part Number - 380104-444

Radiator, Aluminum

▼ OEM Reference

CT A0000-27676	TY 16410-U2170-71	TY 16420-U3500-71
CT A0000-29270	TY 16410-U2171-71	TY 16450-23430-71
MB A0000-27676	TY 16420-F2100-71	TY 16460-23430-71
MB A0000-29270	TY 16420-U2170-71	TY 16460-U2230-71
TY 16410-F2100-71	TY 16420-U2230-71	

Replacement Cap: 380104-494



Part Number - 380009-117-01

**Radiator
(OEM part)**

▼ OEM Reference
NI 21450-FC00A

Replacement Cap: 380009-104



Part Number - 380106-436

Radiator

▼ OEM Reference
CT 93E01-00010
MB 93E01-00010

Replacement Cap: 380009-104



Part Number - 380009-118-01

**Radiator
(OEM part)**

▼ OEM Reference
HY 1388911
YT 580002232

Replacement Cap: 380104-493



Part Number - 380009-119-01

**Radiator
(OEM part)**

▼ OEM Reference
HY 4606206
YT 582006670

Replacement Cap: 380009-102



Part Number - 380104-468

Radiator

▼ OEM Reference

CT A0000-19618	HY 2035469	MB A0000-28106
CT A0000-27667	HY 2037315	YT 520035884
CT A0000-28101	HY 2038182	YT 520035896
CT A0000-28106	HY 2038183	YT 524140817
HY 1375908	HY 2057820	YT 580003258
HY 1375909	MB A0000-19618	YT 580013390
HY 1379810	MB A0000-27667	YT 580013391
HY 2000153	MB A0000-28101	YT 580037662

Replacement Cap: 380009-102



Part Number - 380009-120-01

**Radiator
(OEM part)**

▼ OEM Reference
HY 2066914
NI 21450-FK30A
YT 524205368

Replacement Cap: 380009-104



Part Number - 380009-100

Lower Hose

▼ OEM Reference
HY 2064054
YT 580044223



Part Number - 380104-663

Radiator Hose (Upper)

▼ OEM Reference
CT 93B01-00200 CT 93E01-10200 MB 93E01-00200
CT 93B01-10200 MB 93B01-00200 MB 93E01-10200
CT 93E01-00200 MB 93B01-10200



Part Number - 380009-107

Lower Hose

▼ OEM Reference

KO 3EB-04-23220 KO 3EB-04-A5122 KM 8761217
KO 3EB-04-A5121 KM 4949229



Part Number - 380009-101

Upper Hose

▼ OEM Reference
HY 2064053
YT 580044222



Part Number - 380009-113

Lower Hose

▼ OEM Reference

AC 8777796
KO 3EB-04-A7511



Part Number - 380009-108

Upper Hose

▼ OEM Reference

TY 16511-12810-71 KO 3EB-04-A5131 KM 8761218
TY 16511-16640-71 KO 3EB-04-A5132



Part Number - 380009-125

Lower Hose

▼ OEM Reference

TY 16512-22810-71
TY 16512-23420-71
TY 16512-26600-71



Part Number - 380009-110

Upper Hose

▼ OEM Reference

KO 8777797 KO 3EB-04-A7520
KO 8779168 KO 3EB-04-A7521



Part Number - 380009-130

Lower Hose

▼ OEM Reference

TY 16512-12800-71
TY 16512-16640-71



Part Number - 380009-124

Upper Hose

▼ OEM Reference

TY 16511-23340-71
TY 16511-26600-71



Part Number - 380104-580

Radiator Hose (Lower)

▼ OEM Reference

CT 91B01-10400 MB 91B01-10400 NI 21503-FJ101
CT 93E01-00300 MB 93E01-00300 TY 800129308
CT 91B01-00400 MB 91B01-00400
HY 800129308 NI 21503-FJ100



Part Number - 380009-129

Upper Hose

▼ OEM Reference

TY 16511-12800-71



Part Number - 380104-596

Radiator Hose (Lower)

▼ OEM Reference

HY 2059211 YT 580038861
HY 2074397 YT 580056738



Part Number - 380009-109

Bypass Hose

▼ OEM Reference

CT 91H20-02770 KA 8761960 NI 14080-50K00
DA D490732 MI 91H20-02770

Radiators and Accessories



Part Number - 380009-104

Radiator Cap

▼ OEM Reference

AC 4949074	KM 4949074	NI 21430-FK300
AC 8761209	KM 8761209	TC 222A2-10211
CL 925303	KO CPC89C0025010	TY 16401-23000-71
CL 926014	KO CPC89C0175010	TY 16401-U2000-71
CT 42713-30600	NI 21430-01F02	YT 901900802
HY 2022397	NI 21430-91H00	YT 901913802



Part Number - 380009-102

Radiator Cap

▼ OEM Reference

HY 1352140
YT 505972563



Part Number - 380009-126

Thermostat Gasket

▼ OEM Reference

HY 1330725



Part Number - 380009-127

Thermostat Gasket

▼ OEM Reference

TY 16341-76017-71



Part Number - 380009-103

Thermostat/O-Ring

GM 2.4L Engines 192°

▼ OEM Reference

HY 1584121
YT 580056945



Part Number - 380009-132

Thermostat

▼ OEM Reference

HY 4111238
YT 582041305



Part Number - 380009-105

Thermostat/Gasket

H2O II Engines 170°

▼ OEM Reference

AC 8761954	KO 21200-50K00	NI 21200-96015
AC 8772261	KO 21200-53J00	NI 21200-96061
CT 32A46-02100	KO 21200-VJ200	NI 21200-OC811
CT 91H20-02680	KO 21200-VJ200K0	NI 21200-VJ200
HY 301793	KO 600-421-6110	NI 21200-VJ200D
KM 8761954	KO 600-421-6210	NI 21200-VJ200N
KO 01NI21200-VJ200	KO 6140-11-6310	NI 21200-VJ200S
KO 21200-OC811	NI 21200-58G04	TUSK 8761954



Part Number - 380030-120

Thermostat/O-Ring, 4Y Engine, 170°

▼ OEM Reference

TC 212T1-08481	TY 90916-03950-71
TY 9001A-97002	

Replacement Gasket: 380009-127



Part Number - 380009-106

Thermostat/Gasket

A15, J15, H2O Engines 180°

▼ OEM Reference

CL 907438	HY 151570	TY 80916-76085-71
CL 911166	HY 231522	TY 90916-03037
CL 913788	HY 324370	TY 90916-03954-71
CL 920235	KM 4920199	YT 524253576
CT 91920-05100	KM 4942370	YT 580000179
DW A218287	NI 21200-G3100	YT 580000381
HY 1361820	TY 16302-U2120-71	YT 580024168
HY 1450643	TY 80916-76032-71	YT 901282847
HY 1450696	TY 80916-76033-71	
HY 1495428	TY 80916-76065-71	

Replacement Gasket: 380009-126



Part Number - 380020-008-02-R

Shoe - Right Hand (2)

- ▼ OEM Reference
- HY 1565314
- KO 3EB-K3-0204C
- YT 580051333
- YT 524248309



Part Number - 380020-008-02-L

Shoe - Left Hand (2)

- ▼ OEM Reference
- HY 1565313
- KO 3EB-K3-0203C
- YT 580051332
- YT 524248308



Part Number - 380020-001-02

Brake Shoe Kit (4)

- ▼ OEM Reference
- KO 3EB-30-A31180
- NI 44999-22H00
- TY 00591-27305-81
- TY 00591-34821-81
- TY 00591-43054-81
- TY 00591-57969-81



Part Number - 380020-002-02

Brake Shoe (2)

A pin is included in this kit to make it adaptable for RH or LH use. Kit includes 2 shoes to do one side of the truck. Need to order 2 kits if doing both sides.

▼ OEM Reference

- | | |
|-----------------|------------------|
| TC 20803-71151 | KO 3EA-30-1145C |
| TC 20803-71161 | TY 47510-U113071 |
| KO 3EA-30-1144C | TY 47520-U113071 |



Part Number - 380020-003-02

Brake Shoe (2)

- ▼ OEM Reference
- HY 1334620
- YT 1500132-07
- YT 5059595-61
- HY 1363007



Part Number - 380020-004-02

Brake Shoe (1)

▼ OEM Reference

- | | | |
|----------------|-----------------|------------------|
| AC 8761527 | CT 91546-12600 | NI 44070-22H60 |
| AC 8761528 | KO 3EB-30-31150 | NI 44070-22H70 |
| AC 8761529 | KO 3EB-30-31160 | TY 47503-3386071 |
| CT 91446-17100 | KO 3EB-30-31170 | TY 47504-3386071 |
| CT 91546-12500 | NI 44060-22H60 | TY 47505-3386071 |



Part Number - 380020-019-01

Brake Shoe (1)

▼ OEM Reference

- | | | |
|-----------------|-----------------|-------------------|
| AC 4940527 | KO 3EA-30-31170 | NI 44070-FJ500 |
| AC 4940532 | MB 91246-16800 | NI 44070-FJ510 |
| AC 4940535 | MB 91246-16900 | TY 47403-12810-71 |
| CT 91B46-10313 | MB 91246-17100 | TY 47403-13300-71 |
| CT 91B46-10314 | NI 44060-00H00 | TY 47403-16600-71 |
| CT 91B46-10412 | NI 44060-00H60 | TY 47404-12810-71 |
| DW A273363 | NI 44060-11H03 | TY 47404-13300-71 |
| DW A273364 | NI 44060-11H06 | TY 47404-16600-71 |
| DW A273365 | NI 44060-FJ500 | TY 47405-12810-71 |
| KO 32532-21500 | NI 44060-L0105 | TY 47405-13000-71 |
| KO 32532-21600 | NI 44070-00H60 | TY 47405-13300-71 |
| KO 3EA-30-11410 | NI 44070-00H70 | TY 47405-16600-71 |
| KO 3EA-30-11420 | NI 44070-0K301 | TY 47505-13000-71 |
| KO 3EA-30-11430 | NI 44070-0K311 | TY 47506-13000-71 |
| KO 3EA-30-31150 | NI 44070-11H06 | |
| KO 3EA-30-31160 | NI 44070-11H16 | |



Part Number - 380020-006-02

Brake Shoe (2)

▼ OEM Reference

- | | | |
|-----------------|------------------|--------------|
| HY 1334640 | KO 3EB-30-23450 | YT 505963591 |
| HY 1358223 | TC 22433-79901 | YT 918259300 |
| KO 3EB-30-2300K | TC CK21122083000 | YT 930132400 |



Part Number - 380020-007-02

Brake Shoes (4)

▼ OEM Reference

- NI 44999-00H00
- NI 44999-11H00
- NI 44999-L1400



Part Number - 380020-010-02

Brake Shoe (2)

▼ OEM Reference

- | | | |
|-----------|-----------------|-------------------|
| CL 932683 | KO 3EB-30-3158C | TY 47510-U2130-71 |
| CL 932684 | KO 3EB-30-3159C | TY 47520-U2130-71 |



Part Number - 380020-011-02
Brake Shoe (2)

▼ OEM Reference

HY 1463226	KM 8761128	KO 3EC-30-11840
HY 1463229	KO 3EC-30-11601	YT 580011203
HY 2047122	KO 3EC-30-1162LH	YT 580011206
HY 2047123	KO 3EC-30-1172RH	YT 902392851
KM 8761124	KO 3EC-30-11830	YT 902392861



Part Number - 380020-016-01
Brake Shoes (4)

▼ OEM Reference
NI 44999-FK000



Part Number - 380020-017-02
Brake Shoe (1)

▼ OEM Reference

TC 22673-72022	TY 47405-22550-71
TC 47405-23600-71	TY 47405-23600-71
TY 47401-33240-71	TY 47405-33660-71



Part Number - 380020-012-02
Brake Shoe (2)

▼ OEM Reference

HY 2026303
HY 2026787
YT 915046300
YT 927113300
YT 929151300



Part Number - 380020-020-01
Brake Shoe (1)

▼ OEM Reference

CT 91E46-00113	MB 91E46-00113
KO 3EB-30-41360	NI 44060-FK000



Part Number - 380020-013-02
Brake Shoe (2)

▼ OEM Reference

HY 1591664
YT 580059824



Part Number - 380020-018-02
Brake Shoe (1)

▼ OEM Reference

CT 91846-17200	KM 8765282	TY 47403-23300-71
CT 91846-17300	KO 3EC-30-11611	TY 47404-23300-71
CT 91846-17400	KO 3EC-30-11621	TY 47405-23300-71
HAM 3EC-30-11810	KO 3EC-30-11721	TY 47504-22752-71
HAM 8765280	KO 3EC-30-11810	TY 47505-22752-71
KM 8765280	KO 3EC-30-11820	TY 47506-22752-71
KM 8765281	KO 3EC-30-11920	



Part Number - 380020-014-02
Brake Shoe (2)

▼ OEM Reference

HY 1591665
YT 580059825



Part Number - 380100-894
Brake Shoe (1)

▼ OEM Reference

CT 91E46-00212
KO 3EB-30-41380
MB 91E46-00212
NI 44070-FK000



Part Number - 380020-015-02
Brake Shoe (1)

▼ OEM Reference

KM 4940946	KO 3EB-30-23440	TY 47403-32062-71
KM 4940947	KO 3EB-30-24430	TY 47404-32062-71
KO 3EB-30-23430	KO 3EB-30-24440	



Part Number - 380100-895
Brake Shoe (1)

▼ OEM Reference

CT 91E46-00114
KO 3EB-30-41370
MB 91E46-00114
NI 44070-FK010



Part Number - 380100-896
Brake Shoe (1)

▼ OEM Reference
TY 47403-26640-71



Part Number - 380100-898
Brake Shoe (1)

▼ OEM Reference
TY 47405-26640-71



Part Number - 380023-021
Brake Drum

▼ OEM Reference
KO 3EB-21-25310
KO 3EB-21-42230



Part Number - 380030-031
Spring

▼ OEM Reference

CT 91246-04500	NI 44147-00H00	TY 47472-U1130-71
KM 4940538	NI 44147-11H04	
KO 3EA-30-11340	TY 47472-11631-71	



Part Number - 380030-024
Spring

▼ OEM Reference

AC 4942534	KO 4942534	NI 44090-22H10
CL 932573	KO 4942606	TY 47434-32500-71
CT 91846-14100	KO 4968244	TY 47438-33060-71
KM 4942534	KO 34B-30-14351	TY 47438-U3130-71
KO 4941616	KO 3EC-30-11350	



Part Number - 380030-057
Spring

▼ OEM Reference

CT 91246-03400	NI 44070-L0100	TY 47635-10110-71
KM 4941373	NI 44090-L1400	TY 47675-11630-71
KO 300-32-31760	TC C521100304010	TY 47675-U1130-71



Part Number - 380030-059
Spring

▼ OEM Reference

CL 932574	MB 91446-03900	TY 47438-U2130-71
KM 4942605	NI 44090-22H00	
KO 3EC-30-11340	TY 47438-32060-71	



Part Number - 380030-025
Spring

▼ OEM Reference

CL 932575	KO 8763193	NI 44147-22H00
HY 2037340	KO 8765283	TY 47472-21801-71
KM 4920659	KO 3EB-30-31320	TY 47472-U2130-71
KM 8763193	KO 3EC-30-11360	YT 900955827
KO 4942607	KO 3EC-30-31320	
KO 8761532	MB 91846-12500	



Part Number - 380030-100
Spring Kit (2)

▼ OEM Reference

HY 1334638
HY 1565316
YT 580051335
YT 913589300



Part Number - 380030-023
Spring

▼ OEM Reference

AC 4941622	HAM 3EC-30-15750	MB 91246-03600
CL 932582	HY 350379	NI 44024-L0700
HAM 4941622	KM 4906137	NI 44026-L0100
HAM 4969577	KM 4920622	NI 44083-00H00
HAM 8761530	KM 4941622	TY 47636-10110-71
HAM 34B-30-14420	KO 34B-30-14420	TY 47636-U1100-71



Part Number - 380030-058
Spring

▼ OEM Reference

CL 932576	KO 34B-30-14320	TC C521123254540
CT 91446-02500	KO 3EC-30-11330	TY 47435-32060-71
KM 4941613	NI 44039-22H00	TY 47435-U2130-71



Part Number - 380030-172
Spring

▼ OEM Reference

AC 4974326	HAM 4974326	TC 521103625160
CT 97546-01800	KO 3EA-30-11250	TY 47511-22500-71
HAM 3EA-30-11250	NI 44214-00H00	TY 47513-U1130-71



Part Number - 380030-119
Spring

▼ OEM Reference

AC AC4940530	KO 3EA-30-11150	TY 47512-U1130-71
CT 97546-01700	NI 44214-00H10	
KM 4940530	TY 47512-22500-71	



Part Number - 380023-015
Spring

▼ OEM Reference

AC	3EB-30-42160	KM	8761534	TC	C521121815161
CL	932566	KO	3BB-30-12160	TY	47462-32500-71
CT	91446-03200	KO	3EB-30-42160	TY	47462-U2130-71
HY	2037332	NI	44214-22H01	YT	900955814



Part Number - 380030-081
Spring

▼ OEM Reference

KO	3BB-30-12260
----	--------------



Part Number - 380023-002
Plate, Disk Brakes

▼ OEM Reference

DW	D700251
----	---------



Part Number - 380023-003
Friction Plate, Disk Brakes

▼ OEM Reference

DW	D141112
----	---------



Part Number - 380020-005-02
Brake Pad (1)

▼ OEM Reference

TY	47117-1224071
AC	4943897
CT	97046-21800
TC	C51M001507405
KO	3BA-30-31731



Part Number - 380023-005
Accelerator Pedal

▼ OEM Reference

HY	1383672
YT	915356400



Part Number - 380023-022
Accelerator Pedal

▼ OEM Reference

MB	91351-24800
----	-------------



Part Number - 380023-039
Pedal Pad, Emergency Brake

▼ OEM Reference

TY	46165-26660-71
TY	46165-U2230-71



Part Number - 380023-001-02
Brake Pedal Pad

▼ OEM Reference

KO	3EB-36-31130
----	--------------



Part Number - 380023-008
Brake Pedal Pad

▼ OEM Reference

AC	8761606	HY	3045352	TY	31319-20540-71
CL	446183	TY	00591-10808-81	TY	31319-23000-71
CL	7000977	TY	00591-35270-81	YT	220004289
CT	0971315	TY	00591-53231-81		



Part Number - 380023-004
Sheave, Brake

▼ OEM Reference

HY	1334644	KO	3EC-30-11180	TY	919139450
KO	4944644	MB	91446-03800		
KO	3BB-30-12180	NI	44025-22H00		



Part Number - 380030-075
Emergency Brake Handle

▼ OEM Reference

KO	3EB-39-41112
----	--------------



Part Number - 380023-009
Emergency Brake Handle

▼ OEM Reference

HY	1376557
YT	580013352



Part Number - 380023-010
Emergency Brake Handle

▼ OEM Reference

TY	46102-23470-71
TY	46106-23320-71



Part Number - 380101-768
Emergency Brake Handle

▼ OEM Reference

CT	91351-21500
CT	91352-09200
MB	91351-21500
MB	91352-09200



Part Number - 380023-020
Emergency Brake Handle

▼ OEM Reference
CT 91A51-20010
MB 91A51-20010
NI 36010-FK101



Part Number - 380023-028
Cable - Parking Brake

▼ OEM Reference
TY 46401-10920-71



Part Number - 380023-014
Emergency Brake Cable

▼ OEM Reference
HM 3EB-30-31340 KM 8766089 KO 3EB-30-31340
KM 8761537 KO 3EB-30-11232



Part Number - 380023-034
Cable Sub-Assy, Parking Brake (RH)

▼ OEM Reference
TY 47403-26601-71



Part Number - 380023-017
Emergency Brake Cable

▼ OEM Reference
KO 3EB-30-51110



Part Number - 380030-311
Parking Brake Cable

▼ OEM Reference
TY 47503-36640-71



Part Number - 380023-018
Emergency Brake Cable

▼ OEM Reference
KO 3EB-30-51120



Part Number - 380023-027
Parking Brake Cable, Release

▼ OEM Reference
HY 1462535
YT 580011065



Part Number - 380023-011
Emergency Brake Cable

▼ OEM Reference
CT 91E46-00215
NI 36530-FK001



Part Number - 380030-003
Brake Adjuster Cable

▼ OEM Reference
AC 8761533 KM 8761533 NI 44215-22H00
HAM 4923069 KO 3BB-30-12190 TY 47470-33060-71
HAM 8761533 MB 91546-02300 TY 47470-U2130-71
HAM 3BB-30-12190



Part Number - 380023-012
Emergency Brake Cable

▼ OEM Reference
CT 91E46-00119
NI 36531-FK001



Part Number - 380101-601
Emergency Brake Cable

▼ OEM Reference
CT 14486320 HY 2077120 YT 924306402
CT A0000-16288 HY 2077246 YT 932864402
HY 2021620 MB A0000-16288 YT 932866402
HY 2026768 TY 00591-76876-81 YT 932867402
HY 2074978 YT 919492402



Part Number - 380030-004
Brake Adjuster Cable

▼ OEM Reference
AC 4940537 KM 4940537 NI 44215-00H00
HAM 4940537 KO 3EA-30-11330 TY 47501-11630-71
HAM 3EA-30-11330 MB 91246-04400 TY 47504-U1130-71



Part Number - 380023-024
Cable - Parking Brake LH

▼ OEM Reference
TY 47404-26601-71



Part Number - 380023-029
Spring - Brake Shoe Hold Down

▼ OEM Reference
TY 47435-23420-71



Part Number - 380030-266

Cup Shoe Hold Down

▼ OEM Reference

AC 3ED-30-31240	HY 3143330	NI 44043-50H05
AC 34C-30-11561	HY 66002725	NI 44043-L1101
AC 3EC-30-11370	JU 50442744	NI 44043-L9000
AC 4942608	KO 34C-30-11561	NI C-52-51302-53840
AC 4942643	KO 3EC-30-11370	TC 44043-50H05
AC 4969579	KO 3EC-30-15770	TC 44043-L1101
BK KM3EC-30-11370	KO 3ED-30-31240	TC 44043-L9000
CL 448575	KO 3FA-80-15640	TC C-52-51302-53840
CT 1033433	KO 3LA-61-11341	TY 47443-30410-71
CT 32051-00250	KO 4942608	YT 220018411
CT 50442744	KO 4942643	YT 220020606
CT 91846-02700	KO 4969579	YT 220043330
CT NL110000132	LI KM3EC-30-11370	YT 220044330
HN 52-51302-53840	MB 1033433	YT 220077636
HY 2037341	MB 32051-00250	YT 66002725
HY 3049444	MB 50442744	YT 900750841
HY 3121721	MB 91846-02700	
HY 3124657	MB NL110000132	



Part Number - 380023-025

Adjuster, Brake (RH)

▼ OEM Reference

AC 304-32-32200	HY 1334645	MB 52-11211-23300
AC 34B-30-14240	HY 3056759	MB 52-11211-23301
AC 34B-30-14241	HY 3132225	MB 64335-50214
AC 4941610	JU 14322770	MB A0000-01934
CL 7001098	JU 14499700	TY 00591-06302-81
CT 0A1934	KO 304-32-32200	TY 00591-35456-81
CT 12J41-2330	KO 34B-30-14240	TY 00591-58148-81
CT 1921-64078	KO 34B-30-14241	TY 00591-58198-81
CT 1921-64300	KO 4941610	TY 47460-32060-71
CT 217054	MB 0A1934	YT 220020229
CT 52-11207-23300	MB 12J41-2330	YT 220023825
CT 52-11211-23300	MB 1921-64078	YT 220077627
CT 52-11211-23301	MB 1921-64300	YT 505963554
CT 64335-50214	MB 217054	YT 900488810
CT A0000-01934	MB 52-11207-23300	



Part Number - 380023-013

Brake Shoe Hold Down Kit

▼ OEM Reference

HY 2026114
HY 2026786
YT 926640300
YT 929150300



Part Number - 380023-026

Adjuster, Brake (LH)

▼ OEM Reference

AC 304-32-31200	HY 1334646	MB A0000-01935
AC 34B-30-14140	JU 14156550	TY 00591-06301-81
AC 34B-30-14141	JU 14499740	TY 00591-35433-81
AC 4941607	KO 304-32-31200	TY 00591-58149-81
CL 7001079	KO 34B-30-14140	TY 47450-32060-71
CT 12J41-1330	KO 34B-30-14141	TY 47605-30200-71
CT 1921-64077	KO 4941607	TY 47705-30200-71
CT 1921-64299	MB 12J41-1330	TY 47751-30200-71
CT 217121	MB 1921-64077	TY 47761-30200-71
CT 52-11207-13300	MB 1921-64299	TY 47762-30200-71
CT 52-11211-13300	MB 52-11207-13300	YT 220019815
CT 52-11211-13301	MB 52-11211-13300	YT 220023824
CT 91446-03300	MB 52-11211-13301	YT 505963556
CT A0000-01935	MB 91446-03300	YT 900488809



Part Number - 380105-134

Spring

▼ OEM Reference

HY 1367774	TY 00591-76746-81
HY 3057560	TY 47635-U1100-71
JU 14102310	YT 220037560
TY 00591-45157-81	YT 900094807
TY 00591-45162-81	

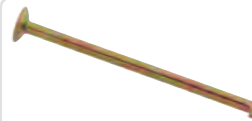

Part Number - 380023-030

Pin - Brake Shoe Hold Down

▼ OEM Reference

TY 47431-22000-71



Part Number - 380105-129

Spring

▼ OEM Reference

CT A0000-25047	MB A0000-25047	TY 47442-U2100-71
CT A0000-25302	MB A0000-25302	YT 220034796
HY 3030147	TY 47442-22000-71	YT 66000872

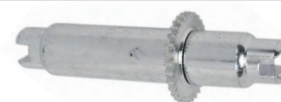

Part Number - 380023-016

Brake Adjuster (LH)

▼ OEM Reference

CT 91E46-10115	KO 3EB-30-51430	NI 44201-FK000
HY 1600491	MB 91E46-10115	YT 580062998

Miscellaneous Brake Parts



Part Number - 380023-006

Brake Adjuster (LH)

▼ OEM Reference

AC 3EC-30-11150	LP 612-3005	TY 47460-36610-71
CT 91446-06400	LP 612-3305	TY 00591-20843-81
CT 91846-01300	LP 612-3707	TY 00591-35462-81
CL 448356	LP 612-3710	TY 00591-43843-81
CL 7001103	LP 612-3719	TY 00591-58150-81
HY 3115501	LP 622-1125	TY 00591-58200-81
HY 3142334	MB 91446-06400	TY 47460-21800-71
HY 3143730	MB 91846-01300	TY 47460-32500-71
HY 2037327	NI 44201-22H00	TY 47460-U2130-71
JU 143574401	TC 44201-22H00	YT 220043730
KO 3EC-30-11150	TC C-52-11239-13300	YT 900955806



Part Number - 380023-019

Brake Adjuster (LH)

▼ OEM Reference

CT 91E46-10213	KO 3EB-30-51450	NI 44200-FK000
HY 1600492	MB 91E46-10213	YT 580062999



Part Number - 380023-007

Brake Adjuster (RH)

▼ OEM Reference

AC 3EC-30-11230	LP 612-3304	TY 00591-35461-81
CT 91444-06500	LP 612-3706	TY 00591-43842-81
CT 91846-01400	LP 622-1124	TY 00591-52259-81
CL 7001102	MB 91444-06500	TY 00591-58199-81
HY 3038290	MB 91846-01400	TY 47450-21800-71
HY 3060453	NI 44200-22H00	TY 47450-32500-71
HY 2037328	TC 44200-22H00	TY 47450-U2130-71
JU 143574503	TC C-52-11239-23300	TY 47450-36610-71
KO 3EC-30-11230	TN 32299	YT 220077835
LP 612-3004	TY 00591-20846-81	YT 900955807



Part Number - 380030-278

Pedal, Parking Brake

▼ OEM Reference

TY 46110-26610-71
TY 46110-26612-71
TY 46110-U2230-71
TY 46120-26610-71

Pipes



Part Number - 380007-001-02

Exhaust Pipe

▼ OEM Reference

AC 4949214
KO 3EB-03-22110
TY 00591-06324-81



Part Number - 380007-005-02

Exhaust Pipe

▼ OEM Reference

TY 17401-16600-71



Part Number - 380007-002-02

Exhaust Pipe

▼ OEM Reference

KO 3EB-03-35311



Part Number - 380103-791

Muffler

▼ OEM Reference

NI 20100-FC301
NI 20100-FC30A
NI 20100-GH10A



Part Number - 380007-003-02

Muffler

▼ OEM Reference

KO 3EB-03-A6610



Part Number - 380021-004-02
Brake Cylinder

▼ OEM Reference

CT 91484-27100	RA 1-164-912
CT 91484-27101	RA 1-164-915
CT 91484-37100	RA 750
MB 1015776	RA 990-253
MB 91484-17100	TY 00591-35379-81
MB 91484-27100	TY 00591-58010-81
MB 91484-27101	TY 47530-42100-71
MB 91484-37100	

CL 7001049
CT 1015776
CT 1015777
CT 91484-17100



Part Number - 380030-063
Master Cylinder

▼ OEM Reference
KO 3EB-36-51180



Part Number - 380030-090
Master Cylinder

▼ OEM Reference
AT 47530-U2100-71
TY 47530-13201-71
TY 47530-13400-71
TY 47530-U2100-71
TY 47530-U2100-71A



Part Number - 380021-003-02
Brake Cylinder

▼ OEM Reference

CL 7001081	JU 14495460	TY 00591-58023-81
HY 1347048	MA M45110	YT 220037522
HY 3057522	TY 00591-35435-81	YT 505963537



Part Number - 380021-002-02
Brake Cylinder

▼ OEM Reference

CT 91346-40300
CT 93146-02500
CT 93146-12500
MB 93146-02500
MB 93146-12500



Part Number - 380021-001-02
Master Cylinder

▼ OEM Reference

AC 8761597
AC 8766117
KO 3EB-36-31280
KO 3EB-36-31281
KO MY022-8098-00
TY 00591-27394-81



Part Number - 380021-005-01
Master Cylinder

▼ OEM Reference

LP 605-7053
TY 47210-23321-71
TY 47210-U2170-71



Part Number - 380021-006-01
Master Cylinder

▼ OEM Reference

HY 2021338
LP 605-7012
YT 915435400



Part Number - 380021-008-02
Master Cylinder

▼ OEM Reference

CT 91A46-10100
MB 91A46-10100
NI 46010-FJ100



Part Number - 380030-166
Master Cylinder

▼ OEM Reference
KM 4949450
KM 4967822
KO 3BA-36-21101
KO 3EB-36-22700



Part Number - 380030-167
Master Cylinder

▼ OEM Reference
KM 4940552
KO 3EA-36-11100



Part Number - 380030-091
Master Cylinder

▼ OEM Reference
NI 46010-04H00
NI 46010-11H01



Part Number - 380021-007-01
Master Cylinder

▼ OEM Reference
HY 1536724
YT 580040436



Part Number - 380050-051
Wheel Cylinder
Bore size 1 1/2"

▼ OEM Reference

CL 932561	KM 4940945	TY 47410-21580-71
CT 215467	KM 4949375	TY 47410-21800-71
CT 91446-00900	KO 34B-30-14311	TY 47410-22500-71
CT 91846-00800	KO 34B-30-15311	TY 47410-32500-71
HY 1334648	KO 3EB-30-11310	TY 47410-U2130-71
HY 2027398	NI 44100-22H00	YT 505963500
KM 4920078	TC C521124652001	YT 900488803

Cylinders



Part Number - 380050-052

Wheel Cylinder
Bore size 1 1/8"

▼ OEM Reference

CT	91E46-00112	NI	44100-FK000
HY	1565290	YT	580051320
KO	3EB-30-41440		



Part Number - 380050-053

Wheel Cylinder
Bore size 7/8"

▼ OEM Reference

AC	8761142	KO	3EA-30-25111	TC	C521102952000
CT	91246-01800	NI	44100-00H00	TY	47410-10480-71
CT	91B46-00312	NI	44100-11H01	TY	47410-11630-71
DW	A251738	NI	44100-FJ500	TY	47410-12000-71
KM	4941515	NI	44100-FJ501	TY	47430-11630-71
KO	325-32-21400	NI	44100-L1400		



Part Number - 380055-060

Wheel Cylinder
Bore size 1 1/8"

▼ OEM Reference

CT	93446-01300	KM	8765304	TY	47410-32060-71
KM	4940951	KO	3EC-30-12120		
KM	4944669	KO	3EC-30-39110		



Part Number - 380055-063

Wheel Cylinder
Bore size 7/8"

▼ OEM Reference

HY	2026775
YT	902194803



Part Number - 380055-068

Wheel Cylinder
Bore size 1 1/4"

▼ OEM Reference

AC	8765293	KM	8765293	NI	44100-53H01
CT	91946-00600	KO	3EC-30-21120	YT	580011423
HY	1463341	KO	3EC-30-31110		



Part Number - 380106-149

Wheel Cylinder
Bore size 1 1/8"

▼ OEM Reference

TC	234A3-72001
TY	47410-23420-71



Part Number - 380055-071-01

Tilt Cylinder

5° forward, 8° backward

▼ OEM Reference

HY	2062424
YT	580042216



Part Number - 380055-073-01

Tilt Cylinder

▼ OEM Reference

HY	2071862
YT	580053487



Part Number - 380055-074-01

Tilt Cylinder

▼ OEM Reference

HY	1338742
YT	518841601



Part Number - 380055-075-01

Tilt Cylinder (LH)

▼ OEM Reference

HY	2076686	YT	580060620
HY	2076689	YT	580060623



Part Number - 380055-076-01

Tilt Cylinder (RH)

▼ OEM Reference

HY	2076676	YT	580060616
HY	2076679	YT	580060619



Part Number - 380055-080-01

Power Steering Cylinder

▼ OEM Reference

NI	49509-FC30B
----	-------------



Part Number - 380055-081-01

Side/Shifter Cylinder

▼ OEM Reference

HY	1360125
YT	519666601



Part Number - 380055-082-01

Side/Shifter Cylinder

▼ OEM Reference

CA	6020048
HY	1489016
HY	2043528
YT	580020708



Part Number - 380050-037
Packing Cylinder Kit

▼ OEM Reference

CL 446444	JU 14462360	YT 220021100
CT 973546	TY 00591-22382-81	YT 516149005
HY 2302265	TY 00591-32404-81	
HY 3054917	TY 00591-60962-81	



Part Number - 380050-038
Lift Cylinder O/H Kit

▼ OEM Reference
TY 00591-76586-81
YT 505136031
YT 522375008



Part Number - 380055-054
Lift Cylinder O/H Kit

▼ OEM Reference
CA 561307
TY 04654-U2010-71



Part Number - 380050-039
Lift Cylinder O/H Kit

▼ OEM Reference
CL 7004445 TY 00591-45306-81
HY 2307874 YT 220037756
HY 3057756 YT 505136027



Part Number - 380055-058
Lift Cylinder O/H Kit

▼ OEM Reference
CA 560349



Part Number - 380055-059
Lift Cylinder O/H Kit

▼ OEM Reference
CA 562591



Part Number - 380055-061
Lift Cylinder O/H Kit

▼ OEM Reference
TY 04652-U2020-71



Part Number - 380055-077
Lift Cylinder O/H Kit

▼ OEM Reference
NI 58099-FA400



Part Number - 380055-083
Lift Cylinder O/H Kit

▼ OEM Reference
NI 58099-FA500



Part Number - 380055-084
Lift Cylinder O/H Kit

▼ OEM Reference
NI 58099-FA31B



Part Number - 380030-211
Lift Cylinder O/H Kit

▼ OEM Reference
CL 1813062



Part Number - 380103-060
Lift Cylinder O/H Kit

▼ OEM Reference
HY 1355497
YT 505136041



Part Number - 380103-205
Lift Cylinder O/H Kit

▼ OEM Reference
MB 93051-10068



Part Number - 380055-085
Lift Cylinder O/H Kit

▼ OEM Reference
CT 93051-10078
MB 93051-10078



Part Number - 380103-052
Lift Cylinder O/H Kit

▼ OEM Reference
TY 04654-U1010-71



Part Number - 380055-070
Tilt Cylinder O/H Kit

▼ OEM Reference
HY 1494726
YT 580023428



Part Number - 380055-056
Seal Kit - Tilt Cylinder

▼ OEM Reference
HY 1493306

Cylinder Parts



Part Number - 380050-041

Tilt Cylinder O/H Kit

▼ OEM Reference

HY 2302714	TY 00591-60963-81
HY 3054918	TY 00591-76642-81
JU 1444116	YT 220021877
JU 14441160	YT 506149006
TY 00591-32407-81	YT 516149006



Part Number - 380104-392

Power Steering O/H Kit

▼ OEM Reference

CT 14485550	MB 14485550
CT A0000-07950	MB A0000-07950
HY 1367172	TY 00591-74599-81
HY 2026822	YT 901905851
JU 14485550	YT 901905852



Part Number - 380050-050

Tilt Cylinder O/H Kit

▼ OEM Reference

KO 3EB-64-05190
KM 4948516



Part Number - 380055-055

Power Steering O/H Kit

▼ OEM Reference

KM 4949737
KO 3EB-64-A2000



Part Number - 380055-064

Tilt Cylinder O/H Kit

▼ OEM Reference

HY 1492644
YT 5800224-11



Part Number - 380055-062

Power Steering O/H Kit

▼ OEM Reference

TY 04433-20110-71



Part Number - 380055-065

Tilt Cylinder O/H Kit

▼ OEM Reference

CL 1811697



Part Number - 380055-078

Power Steering O/H Kit

▼ OEM Reference

NI 49599-FC000



Part Number - 380055-066

Tilt Cylinder O/H Kit

▼ OEM Reference

HAM 3EB-64-A5191
KO 3EB-64-A5191



Part Number - 380055-079

Power Steering O/H Kit

▼ OEM Reference

NI 49599-FC00B



Part Number - 380055-067

Tilt Cylinder O/H Kit

▼ OEM Reference

TY 04655-U2010-71



Part Number - 380104-344

Power Steering O/H Kit

▼ OEM Reference

TY 04433-U2050-71



Part Number - 380055-069

Tilt Cylinder O/H Kit

▼ OEM Reference

HY 1494719
YT 580023425



Part Number - 380030-038

Power Steering O/H Kit

▼ OEM Reference

KO ON43001-06565



Part Number - 380055-088

Seal Kit - Steering Cylinder

▼ OEM Reference

YT 580060036



Part Number - 380104-362

Power Steering O/H Kit

▼ OEM Reference

HY 1501412
YT 580026957

Tune-Up Kits and Planned Maintenance Kits

Tune-up kits and planned maintenance kits for IC forklifts offer a convenient, time-saving solution for completing important routine maintenance. Kits help by combining all of the necessary components under a single part number and are available for IC forklifts and engine types from a wide variety of manufacturers.

Tune-Up Kits

Include the distributor cap, rotor, ignition wire set, and spark plugs for the engine type and manufacturer indicated.



Make	Models	Engine Mfg.	Engine	Part Number
Caterpillar	GC25K	Mitsubishi	4G63-4G64	380012-019-03
Daewoo	GC20E-3	Mitsubishi	G424	380012-019-04
Hyster	H50XM	Mazda 2.0L	FE	380012-019-02
Hyster	S50XM	Mazda 2.0L/2.2L	FE/F2	380012-019-02
Hyster	H50XM	General Motors	GM 3.0L	380012-019-05
Hyster	S50XM	General Motors	GM 3.0L	380012-019-05
Hyster	S50FT	Mazda 2.0L/2.2L	FE/F2	380012-019-06
Komatsu	FG25ST-12	Nissan	H20-II	380012-019-01
Mitsubishi	FGC25	Mitsubishi	4G52	380012-019-07
Toyota	7 Series, 8 Series	Toyota	4Y	380012-019
Yale	GLC050VX	Mazda 2.0L/2.2L	FE/F2	380012-019-06



Planned Maintenance Kits

Include high-quality replacement air and oil filters and the recommended amount of 10W30 motor oil for the engine type and manufacturer indicated.



Make	Models	Engine Mfg.	Engine	Part Number
Caterpillar	GC25K	Mitsubishi	4G63-4G64	380012-020-09
Daewoo	GC20E-3	Mitsubishi	G424	380012-020-08
Hyster	H50XM	Mazda 2.0L	FE	380012-020-04
Hyster	S50XM	Mazda 2.0L/2.2L	FE/F2	380012-020-05
Hyster	H50XM	General Motors	GM 3.0L	380012-020-03
Hyster	S50XM	General Motors	GM 3.0L	380012-020-07
Hyster	S50FT	Mazda 2.0L/2.2L	FE/F2	380012-020-10
Komatsu	FG25ST-12	Nissan	H20-II	380012-020-01
Mitsubishi	FGC25	Mitsubishi	4G52	380012-020-02
Toyota	7 Series, 8 Series	Toyota	4Y	380012-020-06
Yale	GLC050VX	Mazda 2.0L/2.2L	FE/F2	380012-020-10



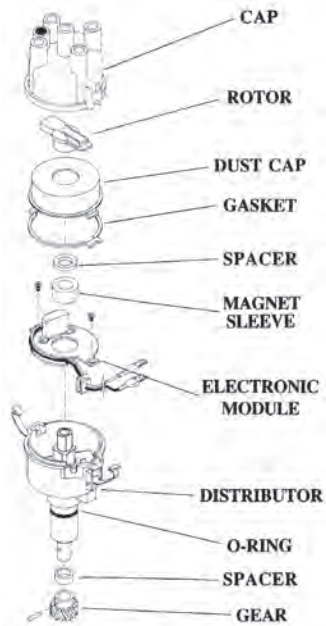

Part Number - 380012-003-02

Distributor - 4Y

▼ OEM Reference

CT A0000-14798	TY 19030-78150-71
ND 290000621	TY 19030-78151-71
TC 212T1-06101	TY 19030-78154-71
TY 19030-UB010	TY 19030-96150
TY 19030-UB010-71	



Part Number - 380012-004-02

Distributor Cap - 4Y

▼ OEM Reference

CL 7000255	TY 00591-53200-81
CT 215154	TY 19101-71010-71
HY 3048471	TY 19101-76007-71
TC 212T1-06111	TY 19101-76013-71
TY 00591-10752-81	YT 220004547
TY 00591-32688-81	



Part Number - 380015-002-02

Rotor - 4Y

▼ OEM Reference

CL 446130	TY 00591-10757-81	TY 19102-73020
CT 215133	TY 00591-63393-81	TY 19102-73021
HY 3046813	TY 19102-16020	TY 19102-73180
HY 3133089	TY 19102-16040	TY 19102-76007-71
HY 3143266	TY 19102-33010-71	TY 19102-76009-71
RN J5-5613	TY 19102-63010-71	TY 19102-76013-71
TC 212T1-06121		



Part Number - 380014-001-02

Ignition Wire Set - 4Y

▼ OEM Reference

TC 20801-0K052	TY 80919-76106-71
TC 212T1-08551	TY 90919-22132
TY 80919-76102-71	



Part Number - 380012-002-02

Distributor - H20II

▼ OEM Reference

AC 8762077	NI 22100-55K10
AC 8762122	TC N-22100-50K10
DW D490742	TY 00591-27353-81
KO 20-203	TY 00591-42798-81
KO 22100-50K10	
KO 22100-50K15	
KO 22100-55K10	
NI 22100-50K10	
NI 22100-50K15	



Part Number - 380012-001-02

Distributor Cap - H20II

▼ OEM Reference

AC 8762078	TC 22162-55K10
DW D490743	TC 22162-55K11
KO 22162-55K10	TY 00591-23165-81
KO 25-011	
NI 22162-55K10	



Part Number - 380015-001-02

Rotor - H20II, 4G63-4G64

▼ OEM Reference

AC 8762079	DW A218357	MB MM611850
BR CK923627	DW D490744	MB T880T-18972
CL 4335223	HN MD618262	NI 22157-55K10
CL 923627	HY 3142510	NI 22157-55K15
CT 91H20-04710	KO 22157-55K10	NI CK923627
CT 914658	KO 26-011	RN J5-5610
CT MD611817	MB 91H20-04710	RN J5-5611
CT MD618262	MB 914658	TC N-22157-55K10
CT MM611850	MB MD611817	TY 00591-23164-81
CT T880T-18972	MB MD618262	YT 220025671



Part Number - 380014-006-02

Ignition Wire Set - H20II

▼ OEM Reference

DW D490816	NI 22450-50K25	TC 20801-0K042
KO 22450-50K25	NI 22450-50K50	TC N-22450-50K50
KO 22450-50K50	NI 22450-50KA0	TY 00591-33605-81
KO 22450-50KA0	TC 20801-0K041	TY 00591-56038-81



Part Number - 380012-013-02

Distributor Cap - Hercules

Style - DC-27

▼ OEM Reference

CL 443487	KM 4911926
DW D700696	MB 7N7542



Part Number - 380012-005-02

Distributor - H20

▼ OEM Reference

AC 4942371*	NI 22100-71317
CL 445285	NI 22100-74011
CL 7000308	NI 22100-K7201
CT 0971564	TC N-22100-49207
HY 3123249	TC N-22100-71306
KO 20-200	TC N-22100-71317
KO 22100-K7201	TC N-22100-K7201
NI 22100-49206	TY 00591-07207-81
NI 22100-49207	TY 00591-32718-81
NI 22100-49210	TY 00591-51220-81
NI 22100-71305	YT 220024204
NI 22100-71306	YT 220025194
NI 22100-71315	

*Old style with points & rotor system, new electronic style is PN 380101-496



Part Number - 380012-011-02

Distributor Cap - 4G32-52-54, H20, A15

▼ OEM Reference

AC 4920234	KO 22162-R9006	SG MD611686
AC 4921224	KO 22162-R9007	TC N-22162-25G10
AC 4949023	MB 1017046	TC N-22162-25G11
CL 3779914	MB MD602756	TC N-22162-R9006
CL 7000312	MB MD602949	TC N-22162-R9007
CL 909351	MB MD607597	TY 00591-03628-81
CL 916005	MB MD611686	TY 00591-31074-81
CT 0971276	MB T232T-46772	TY 00591-32686-81
CT 0971771	NI 22162-11E07	TY 00591-33765-81
CT 1017046	NI 22162-17M01	TY 00591-33766-81
CT 971276	NI 22162-17M03	TY 00591-51412-81
CT 971771	NI 22162-25G10	TY 00591-51418-81
CT MD602756	NI 22162-25G11	TY 00591-51420-81
CT MD602949	NI 22162-A3514	TY 00591-56301-81
CT MD607597	NI 22162-R9006	YT 220000727
CT MD611686	NI 22162-R9007	YT 220012921
CT T232T-46772	NI 2216217M01	YT 220016273
HY 3000542	NI 2216217M03	YT 220054038
HY 3020828	NI CK3779914	YT 220054193
HY 3021276	NI MD611686	YT 901284807
HY 3043274	SG 3779914	YT 901304806
KO 22162-25G11	SG MD611685	



Part Number - 380012-012-02

Distributor Cap - H20

▼ OEM Reference

AC 4969894	KO 22162-78A10	NI 22162-78A00
CL 445294	KO 25-003	NI 22162-78A10
CL 7000253	MB T46371	TC N-22162-G5710
CL 872631	MB 216276	TC N-22162-G5711
CT 46371	NI 22162-G5710	TC N-22162-23G15
CT 216276	NI 22162-G5711	TC N-22162-78A10
HY 3046816	NI 22162-17M02	TY 00591-07216-81
HY 3132609	NI 22162-17M04	TY 00591-32687-81
KO 22162-G5710	NI 22162-23G15	TY 00591-51417-81
KO 22162-G5711	NI 22162-40F00	YT 220012748
KO 22162-23G15	NI 22162-40F10	YT 220024209
	NI 22162-75A10	YT 220070292
	NI 22162-78AX0	



Part Number - 380015-008-02

Rotor - H20, J15

▼ OEM Reference

AC 4942380
KO 22157-05M02
KO 37Z-02-HR901



Part Number - 380015-007-02

Rotor - 4G32-52-54, J15, H20, A15, 4G33

▼ OEM Reference

AC 4920235	CT MD611850	NI 22157-R9007
BR CK909353	KO 22157-R9007	NI CK909353
BR CK916006	MB 1017001	NI CK916006
CL 909353	MB 1041551	
CL 916006	MB MD602758	
CT MD602758	MB MD611850	



Part Number - 380014-008-02

Ignition Wire Set - H20

▼ OEM Reference

AC 4942394	NI 22450-49251	TY 00591-01133-81
CL 1810436	NI 22450-L0150B	TY 00591-06286-81
HY 0214998	NI 22450-L1051	TY 00591-32723-81
HY 3052065	NI 22450-L1125	TY 00591-56004-81
KO HE-2500753	TC 22450-L1051	
KO HE-2500754	TY 00591-00152-81	



Part Number - 380051-001

Ignition Wire Set - 4G52 & 4G54

▼ OEM Reference

CL 909376
CL 1811616
CL 1811917
CL 3779999
KM 4920321



Part Number - 380012-009-02
Distributor - 4G63-4G64

▼ OEM Reference

CL 918313	MB MD169418
CT 1041457	MB T3T65675
CT MD169418	NI MD169418
MB 1041457	TY 00591-42783-81



Part Number - 380012-007-02
Distributor Cap - 4G63-4G64

▼ OEM Reference

CL 4335221	MB MD618364
CL 923626	MB T232T-48372
CT MD618364	NI CK923626
CT T232T-48372	NI MD618364
DW A218353	NP EP-335
HN MD618364	SG MD618364
HY 1554033	TY 00591-75236-81
HY 3127916	YT 220022013
HY 3143902	YT 220043902
	YT 580047018



Part Number - 380015-001-02
Rotor - H20II, 4G63-4G64

▼ OEM Reference

AC 8762079	DW A218357	MB MM611850
BR CK923627	DW D490744	MB T880T-18972
CL 4335223	HN MD618262	NI 22157-55K10
CL 923627	HY 3142510	NI 22157-55K15
CT 91H20-04710	KO 22157-55K10	NI CK923627
CT 914658	KO 26-011	RN J5-5610
CT MD611817	MB 91H20-04710	RN J5-5611
CT MD618262	MB 914658	TC N-22157-55K10
CT MM611850	MB MD611817	TY 00591-23164-81
CT T880T-18972	MB MD618262	YT 220025671



Part Number - 380014-002-02
Ignition Wire Set - 4G63-4G64

▼ OEM Reference

CL 920989	CT MD972033	DW A218378
CL 920990	CT MD972748	MB 1085017



Part Number - 380015-005-02
Rotor - FE-FE2

▼ OEM Reference

HY 1554034
YT 580047019



Part Number - 380012-008-02
Distributor Cap - D5

▼ OEM Reference

HY 1371206	TY 00591-11106-81
HY 3020958	YT 901356802
NP FA-164	



Part Number - 380012-006-02
Distributor Cap - F2-FE

▼ OEM Reference

HY 1326394	TY 00591-33666-81
HY 1339151	TY 00591-56299-81
HY 1370740	TY 00591-56303-81
HY 3054982	YT 150022511
JU 14415530	YT 220020015
JU 14491840	YT 505960556
JU 14501360	YT 505960583
MB T45327	YT 901357802
TC T-FEEN-18-V00	YT 901580802
TY 00591-06004-81	YT 901580812
TY 00591-31680-81	



Part Number - 380015-004-02
Rotor - F2-FE

▼ OEM Reference

CL 444460	NP EP-780	TY 00591-33710-81
CL 446399	RN J5-5614	TY 00591-56318-81
CT 218115	RN J5-5615	TY 00591-56319-81
HY 1326395	TC T-F829-18-V05	TY 00591-56321-81
HY 1362035	TC T-FE2S-18-V05	YT 150022510
HY 1367561	TY 00591-06005-81	YT 220070293
HY 2022460	TY 00591-11046-81	YT 505960565
HY 2023725	TY 00591-31681-81	YT 901356803
MZ F829-18-V05	TY 00591-31813-81	YT 901356814
MZ FE25-18-V05	TY 00591-33617-81	YT 901357803
NP EP-339	TY 00591-33686-81	YT 901953805



Part Number - 380014-005-02
Ignition Wire Set - F2-FE

▼ OEM Reference

CL 7000201	TY 00591-11105-81	YM YA901303803
CL 7000218	TY 00591-33553-81	YT 220100562
HY 1362113	TY 00591-33593-81	YT 505976593
HY 1369893	TY 00591-56029-81	YT 901283805
JU 14364620	TY 00591-61181-81	YT 901303803
JU 14495050	TY 00591-76611-81	



Part Number - 380014-011-02
Ignition Wire Set - FE

▼ OEM Reference

HY 1652460
YT 580078981



Part Number - 380012-014-02
Distributor - H25

▼ OEM Reference

AC 78762077	KO 22100-60K11	NI 22100-60K11
AC 22100-60K15	KO 22100-60K15	NI 22100-60K15
AC 22100-60K15A	KO 22100-60K15A	TC N-22100-60K10
KO 22100-60K10	NI 22100-60K10	TC N-22100-60K15



Part Number - 380012-015-02
Distributor Cap - GM 4.3L

▼ OEM Reference

CT 93720-09911 TY 19101-U3330-71
HY 1566458 YT 580051808



Part Number - 380015-009-02
Rotor - GM 6 cyl, GM 4 cyl, GM 3.0L, GM 4.3L

▼ OEM Reference

HY 1334403



Part Number - 380014-007-02

Ignition Wire Set - GM 3.0L

▼ OEM Reference

DOS A218755 HY 1329534 TY 19335-U2120-71
DW A218755 HY 1337666



Part Number - 380014-012-02

Ignition Wire Set - GM 4.3L

▼ OEM Reference

HY 2088997 TY 580072615
TY 19140-U3330-71



Part Number - 380014-013-02

Ignition Wire Set - GM 6 cyl

▼ OEM Reference

CL 923580
CL 2822859
CT 91921-08300
TY 19035-U3160-71
TY 19110-U3330-71



Part Number - 380012-016-02

Distributor Cap - Nissan TB45

▼ OEM Reference

AC 8775050
KO 8775050
KO 22162-VB011
NI 22162-VB011



Part Number - 380012-017-01

Distributor Cap

▼ OEM Reference

CL 922229 TY 19101-U3160-71
CT 90420-01560 YT 580000314
DW A232132 YT 900005261
HY 1342528



Part Number - 380012-018-01

Distributor Cap

▼ OEM Reference

CL 925036 TY 19101-U2120-71
DW A218736 YT 580000643
HY 1334400



Part Number - 380014-009-02

Ignition Wire Set

▼ OEM Reference

DW A413624
HY 2089846
YT 580073382



Part Number - 380102-570

Ignition Wire Set TB45

▼ OEM Reference

AC 22450-52H25	HY 3144732	KO 8771452
AC 22450-52K25	KO 22450-52H25	KO B2450-52H25
AC 22451-03J11A	KO 22450-52K25	LI 2245103J11
AC 22451-37J15	KO 22451-03J11	MB A0000-25642
AC 4968842	KO 22451-37J15	NI 22450-52H25
AC 4968845	KO 4968842	NI 22451-03J11
AC 4974416	KO 4968843	NI 22451-37J15
AC 8760967	KO 4968845	NI B2450-52H25
AC 8765906	KO 4968846	TC 22451-03J11
AC 8765907	KO 4974416	TC 22451-37J15
AC 8765909	KO 8760967	TC B2450-52H25
AC 8765910	KO 8765906	TY 00591-75718-81
AC 8769404	KO 8765907	YT 220042739
AC 8771452	KO 8765909	YT 220044732
CT A0000-25642	KO 8765910	
HY 3142739	KO 8769404	



Part Number - 380015-006-02

Rotor - TB42 6 cyl, 6G72

▼ OEM Reference

AC 4968831	HY 3122011	RN J5-5612
CL 2572769	KO 22157-52H20	TC N-22157-52H20
CL 444901	MB 1038060	TY 00591-20723-81
CT 1038060	MB MM502535	YT 220018323
CT MM502535	MB T880X17571	
CT T880X17571	NI 22157-52H20	

Distributors/Caps, Rotors, Spark Plug Wires



Part Number - 380015-011-01

Rotor - TB42 & TB45

▼ OEM Reference

AC 8775051	KO 8775051
KO 22157-VB011	NI 22157-VB011

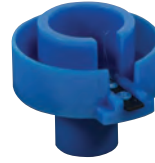

Part Number - 380015-013-02

Rotor

▼ OEM Reference

CL 922221	HY 1342529	TY 19102-31720-71
CL 1342529	HY 1374329	TY 19102-U3160-71
CL 2575926	MB 90420-01480	YT 580000384
CL 922220	NI NF90420-01480	YT 900005266
CT 90420-01480	TY 00591-33685-81	
DW A232133	TY 00591-56322-81	



Part Number - 380015-010-02

Rotor - Peugeot

▼ OEM Reference

CL 7000271	KM 4911933	MB 2W2257
DW D700682	KO HE40-2504609	



Part Number - 380015-012-01

Rotor - GM 4.3L

▼ OEM Reference

TY 19102-U3330-71



Part Number - 370704

Spark Plug Tube

▼ OEM Reference

AC 8760345	HY 3035420	MB A0000-27564
AC TJ-11191-22010	KO 8760345	TY 11191-22010-71
AC TJ-11191-76001-71	KO TJ-11191-22010	TY 11191-76001-71
CT A0000-27564	KO TJ-11191-76001-71	

Coils



Part Number - 380016-001-02

Coil

▼ OEM Reference

CL 925969	MB MD358504
CL 4335230	MB 1832A002
CT MD358504	MB MD326638
CT 1832A002	TY 00591-27426-81
CT MD326638	
DW A218371	



Part Number - 380102-506

Ignition Coil

▼ OEM Reference

HY 1584523
YT 580057203



Part Number - 380016-002-02

Ignition Coil

▼ OEM Reference

CT 91H20-02930	HAM 22448-AR215	NI 22448-AR215
HAM 8772266	NI 22433-AR215	



Part Number - 380016-004-02

Ignition Coil

▼ OEM Reference

CL 1242352
MB 93721-02600
TY 19080-U3330-71



Part Number - 380016-003-02

Ignition Coil

▼ OEM Reference

HY 1652458
YT 580078979



Part Number - 380016-006-02

Ignition Coil

▼ OEM Reference

HY 4110028
YT 582041112

FIVE RING DESIGN - The five rib design prevents flashover and reduces voltage loss. It offers 20% more insulation than conventional plugs. This improved performance is especially significant in plugs with a large gap operating under high voltage.

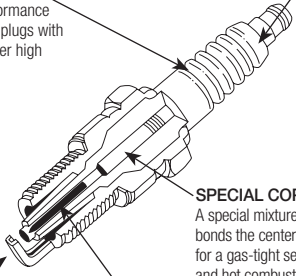

INSULATOR - The insulators are made of a highly purified alumina powder, which gives strength and thermal conductivity at high temperatures, as well as greater physical strength.

SPECIAL COPPER-GLASS SEAL - A special mixture of copper and glass powder bonds the center electrode and insulator together for a gas-tight seal. Proper heat is maintained and hot combustion gases are excluded.

U-GROOVED GROUND ELECTRODE - This U-Groove allows the spark to fill the gap formed by the U. The ball of fire develops, a larger and hotter flash front, so that the combustion is more complete.

COPPER CORED CENTER ELECTRODE - A special center electrode incorporates copper into the core of the nickel chrome binary alloy. This gives superior thermal conductivity, and increases the operating range.

Part Number - 380013-001-02

Spark Plug - W20ES-U

▼ OEM Reference

CT MD851097	PL 43XL	PL B6ES-11
KO 22401-M7716	PL 44N	PL C43N
KO 37Z-02-SP05A	PL 44XL	PL C44N
MB MD851097	PL AG3	PL N288
NI N-22401-M7716	PL AG30C	PL N5C
PL 394	PL AG3CX	PL S43XL
PL 4056	PL AG3X	PL S44XL
PL 43N	PL B6ES	

Part Number - 380013-002-02

Spark Plug - Q14R-U11

▼ OEM Reference

CT 91H20-02860	PL BCP4ES11	PL DCP4ES11
KO 22401-FU412	PL BCP4EY11	PL DCP4EY11
PL BCP4ES	PL DCP4E7	PL FR9DCX
PL BCP4ES11	PL DCP4ES	

Part Number - 380013-004-02

Spark Plug - W14EXR-U

▼ OEM Reference

AC 4516353	CT 1017268	NI 22401-L1600
AC 4933394	HY 3002290	NI 22401-V1414
CL 2385639	HY 3002347	TC N-22401-L1600
CL 4338827	KO 22401-V1414	TY 00591-02042-81
CL 913639	MB 1017268	TY 00591-33646-81
CN SP200S00009RNYC	MB MB1017268	YT 150112466

Part Number - 380013-005-02

Spark Plug - W9EXR-U

▼ OEM Reference

HY 1361837	PL BPR2ES	YT 5059605-35
PL BPR2E	TY 90919-01954-71	

Part Number - 380013-010-02

Spark Plug - W16EXR-U

▼ OEM Reference

AC 4516333
ND W16EXR-U

Part Number - 380013-006-02

Spark Plug - W16EX-U

▼ OEM Reference

AC 4920323	MB MS851101	PL C44NS
CL 909378	PL 4253	PL MS851243
CT 2W9486	PL 44NS	PL N11YC
CT MS851101	PL B2401-89904	PL N12YC
MB 1038083	PL BP5EA-L	PL W16EX-U
MB MS851022	PL BP5EY	TY 90919-01954

Part Number - 380013-007-02

Spark Plug - W9EP

▼ OEM Reference

AC 8762050	PL 14G82	TY 80919-76009-71
BH W10DC	SL 144483	TY 80919-76011-71
CL 444771	TC 20801-OA041	TY 80999-76018-71
CT 0971353	TC N-22401-W8914	TY 90098-09125
HY 0326827	TC W9EP	TY 90098-20395
HY 3002288	TY 00591-06208-81	TY 90919-01021
HY 326827	TY 00591-06209-81	TY 90919-01055-71
KO 22401-W8914	TY 00591-32695-81	TY 90919-01950-71
KO 37Z-02-SP02E	TY 00591-33649-81	TY 90999-09001-71
KO TJ-90098-09125	TY 00591-50973-81	TY 90999-09002-71
KO TJ-90919-01055	TY 00591-50976-81	YT 150038500
KO TJ-90919-01950-71	TY 80098-76006-71	YT 220001599
ND W9EP	TY 80919-76004-71	YT 900537827
NI 22401-W8914	TY 80919-76005-71	
PL 14G22	TY 80919-76008-71	

Part Number - 380013-008-02

Spark Plug - T16PR-U

▼ OEM Reference

BH HR8BC	HY 0388361	TY 00591-32692-81
BH HR8BP	HY 1332675	TY 00591-42808-81
BH HR9BC	HY 1332676	TY 00591-50978-81
CL 446323	HY 1451269	TY 90098-16785
CL 925049	HY 1467579	YT 150112453
CT 216460	ND T16PRU	YT 516484800
DR R-45-TS	TN 07764	YT 580005036
DW A218756	TN 39046	YT 580008972
DW A219024	TY 00591-06165-81	YT 580013445
DX 1411740	TY 00591-10918-81	

Part Number - 380013-009-02

Spark Plug - W16EPR-U

▼ OEM Reference

CT 1038083	PL CR43CXLS	PL RN12YCC
DW A218377	PL CR44NS	PL RN14YC
PL 1Y00-18-110	PL ON11Y	
PL 3322	PL ON12Y	
PL BPR5E	PL R44LT	
PL CR425XLS	PL RN11YCC	

Part Number - 380013-013-02

Spark Plug - Q20PR-U

▼ OEM Reference

DW A223103
NG BCP4E

Part Number - 380013-014-02

Spark Plug - PT16EPR-L13

▼ OEM Reference

BO HR9DPX	ND PT16EPR-L13	TY 19111-U3161-71
BO HR9DPY	NI NF90420-01620	TY 19111-U3330-71
CL 923702	TY 19111-31720-71	TY 90098-66113-71
CT 90420-01620	TY 19111-31721-71	TY 90420-01190-71
HY 1389133	TY 19111-90098-71	YT 900015293
MB 90420-01620		

Part Number - 380013-012-02

Spark Plug - L14-U

▼ OEM Reference

AC 232560	CT 0041663	TY 00591-07885-81
AC 4513315	CT 0631202	TY 00591-07896-81
AC 4613261	CT 0676637	TY 00591-32691-81
AC 4660976	CT 0972385	TY 00591-50970-81
AC 4810105	CT 0973283	TY 00591-50971-81
AC 4905800	CT 2A3643	TY 00591-53307-81
AC 4908597	CT 353706	TY 90098-64015
AC 4910105	CT 8N2630	WK 110532
AC 4916015	DR C-86	WK 209316
BK 101359	DR C-87	WM 10-R-385
BK 101527	HY 0028758	WM 10R1191
BK 115923	HY 0079161	WM 20-7000680
BK 116251	HY 0123872	WM 20-7000681
BK 716D1	HY 0138366	WM 20-7000949
BK 716J1	HY 0197885	WM 20-7100035
CL 3739054	HY 1312459	YT 016254800
CL 742159	HY 1332693	YT 016255000
CL 784250	HY 3001582	YT 016255100
CL 890215	HY 3001585	YT 031314500
CL 890217	HY 3001586	YT 063194200
CL 890221	HY 3001590	YT 150015100
CL 890222	HY 3002287	YT 150112405
CL 890227	HY 3002348	YT 150112406
CL 890245	HY 3002349	YT 150112407
CL 890246	HY 3002575	YT 150112408
CL 890247	HY 3002577	YT 150112409
CL 890255	HY 3040014	YT 150112410
CL 890256	HY 3050408	YT 150112411
CL 890264	HY 3051151	YT 150112413
CL 890271	HY 3051322	YT 150112420
CL 890272	MB 2A3643	YT 150112427
CL 890273	MB 8N2630	YT 220007428
CL 890274	ME 41073	YT 220010987
CL 890276	ME 41273	YT 220011080
CL 907621	ME 41663	YT 220011107
CL 913628	ND L14-U	YT 220011205
CL 913633	NI CK913628	YT 220052206
CL 913638	NP UD-16	YT 509295802
CL 913831	PL 18-10	YT 510764800
CL 940328	PL 18-4	YT 517451800
CN YD6	PL 18-8	
CT 0007954	PL 18-9	

Part Number - 380013-016-02

Spark Plug - T14PR-U

▼ OEM Reference

BH H9BC	JU 14148410	TY 00591-50979-81
BO 242219516	ND T14PR-U	TY 19111-U2120-71
CL 922786	PL 14RF42	TY 90098-14785
DR R-45-RB	PL 14RF52	YT 220013371
HY 0281844	PL 14RF62	YT 580000628
HY 1330468	SB 8155723	

Part Number - 380013-017-02

Spark Plug - W16S-U

▼ OEM Reference

AC 4907334	CT MD997476	ND W16S-U
AC 4948894	CT 851101	PL 14-4
AC 9001652	CT 997476	PL 14-5
BK 716G1	DW 8N2236	PL 14R8
CL 446583	DW D141267	TY 00591-05493-81
CL 890210	DW D700699	TY 00591-10919-81
CL 890219	HY 0360046	TY 00591-20174-81
CL 890220	HY 1312454	TY 00591-33687-81
CL 890225	HY 3001588	TY 00591-55310-81
CL 890236	HY 3002289	TY 80098-76004-71
CL 890252	HY 360046	TY 80098-76005-71
CL 890253	KO HE0052048-00	YT 150112473
CL 890265	KO HE0110256-00	YT 150112490
CL 890267	KO HE0110526-00	YT 150112494
CT 0099476	KO HE40-2502314	
CT 141267	KO HE52892	
CT 8N2236	MB 8N2236	
CT 99476	MB MD997476	
CT MD851101	MB 997476	

Part Number - 380013-018-01

Spark Plug - T20EPR-U

▼ OEM Reference

AB CR42CLTS	CZ RS281YC	MO AGSF32C
AB R42CLTS	CZ RS9YCC	MO AGSF33C
AB R42LTS	CZ RS9YCX	MO AGSF34C
AB R42LTSM	HY 1570595	MO AGSF34EE
AB R43LTS	MO AWRF32	MO AGSF34EEM
AB R43LTSE	MO AWSF22C	MO AGSF34FP
AC DCR42CLTS	MO AWSF22E	NG BPR6EFS
AC DR42CLTS	MO AWSF32C	NG BUR6EFSZ
AC DR42LTS	MO AWSFA32C	NG TR5
AO 103	MO AGFS22FE13J	NG TR5-1
AO 104	MO AGRF2	NG TR6
AO 483	MO AGRF22C	ND T20EPR-U
AO 764	MO AGRF22C1	ND T20EPRU
AO 864	MO AGRF22PP	YT 580052996
AO 985	MO AGRF32	
AO 5144	MO AGRF32C1	
AO 5164	MO AGRP44	
CT A0000-14416	MO AGSF22C	
CZ RS10LC	MO AGSF24C	

Part Number -380013-019-01

Spark Plug - W14EX-U

▼ OEM Reference

AC 45NS	ND W14EXU	TY 00591-03633-81
CL 1332679	ND W14EX-U	TY 00591-32673-81
CL 909377	NG BP4E	TY 00591-50969-81
CL 912703	NG BP4ES	TY 90919-01056
CT 9122000400	NG BP4EY	YT 150112478
CT 91220-00400	NG BP5EA	YT 220034475
HY 3057352	PL 14G52	

Spark Plugs

Part Number - 380013-022-02

Spark Plug - Partial Thread

▼ OEM Reference

AC 22401-FU42A	JU 50459759	NG FR2BD
CT 91H20-12860	KM 22401-FU42A	NI 22401-FU42A
CT A000035707	KO 22401-FU42A	TC 22401-FU42A
HY 1720574	MB 22401-FU42A	YT 550098613
HY 1720575	MB 91H20-12860	YT 76000730
HY 76000730	MB A000035707	

Part Number - 380105-051

Spark Plug - W14LM-U

▼ OEM Reference

AC DLM46	ND W14LM-U
AC DLM49	NG B4LM

Fan Blades



Part Number - 380008-001-02

Fan Blade - K21-K25

▼ OEM Reference

AC 8779236
KO 21060-FU40A
MB 91H20-12670
NI 21060-GY360
TC N21060FU40A



Part Number - 380008-004-02

Fan Blade - H20

▼ OEM Reference

AC 4942359	KO 21060-49003	TC N-21060-48210
CL 445268	KO FN-200	TY 00591-07192-81
CL 7001677	NI 21060-48210	TY 00591-36864-81
HY 3124790	NI 21060-49001	
KO 21060-48210	NI 21060-49003	



Part Number - 380008-002-02

Fan Blade - 4Y 6-7 Series

▼ OEM Reference

AC 8762498	KO YM129900-44700	TY 16361-23860-71
KO YM129900-4470	TC 212T1-05981	YT 220034759



Part Number - 380008-005-02

Fan Blade - 4G63-4G64 K-Series

▼ OEM Reference

CT 91202-07400	MB 91202-07400	TY 00591-27429-81
CT 91202-17400	MB 91202-17400	



Part Number - 380008-003-02

Fan Blade - H20 II

▼ OEM Reference

AC 4901388	KO FN-201	TC N-21060-50K00
DW D491452	NI 21010-50K00	TY 00591-36868-81
KO 21060-50K00	NI 21060-50K00	TY 00591-54141-81
KO 21060-87V00	NI 21060-87V00	



Part Number - 380010-001-02

Belt-Fan

▼ OEM Reference

AC 8761967	KM 8761967	NI 11720-87V10
CL 2781527	KO 11720-52H01-F1	NI 11720-K4080
CT A000013592	KO 11720-87V10	TC N-11720-K4080
DW D490878	KO 11720-K4080	TY 00591-75559-81
KM 4968642	KO 11720-K4080A	

Part Number - 380010-003-02

Belt-Fan

▼ OEM Reference

CL 352780	KO 02117-23523	TY 90916-02975-71
CL 3490402	LP 156-1648	TY 00591-51028-81
CT 91H20-03350	LP 156-17484	TY 90916-02975-71
CT 9L2248	LP 156-9001	YT 295675600
HY 809400	NI 02117-20021	YT 900534806
HY 3057598	NI 02117-20021	YT 220011118
HY 3064467	TC 20801-04081	YT 220052043
HY 104728	TY 16372-13010-71	YT 295675700
HY 2039256	TY 89322-76009-71	

Part Number - 380010-004-02

Belt-Fan

▼ OEM Reference

CL 2814061	HY 3061904	TY 00591-33845-81
CL 3790816	HY 3099227	TY 00591-33876-81
CT 1017158	MB 1017158	TY 00591-33878-81
CT MM115231	MB MM115231	TY 00591-51007-81
HY 1526078	NI 11720-J0300	TY 00591-53127-81
HY 188643	TC 20801-04331	TY 00591-55347-81
HY 2339656	TY 00591-06095-81	YT 580035882

Part Number - 380010-005-02

Belt-Fan

▼ OEM Reference

CT 91921-06300	MB 91921-06300	NI 11720-FM010
CT 91H20-02560	MB 91H20-02560	NI 02117-21521
KO 02117-21521	MB 91H2002560	

Part Number - 380010-011-02

Belt-Fan

▼ OEM Reference

DW A213971
LP 156-20442

Part Number - 380101-813

Belt-Fan

▼ OEM Reference

CT 05910-10046	NI 02117-16523	TY 16371-76006-71
MB 05910-10046	NI 21067-47605	YT 904143100

Part Number - 380101-836

Belt-Fan

▼ OEM Reference

BR 11720-10H05	CT 91402-03400	MB 91402-03400
CT 91402-01200	MB 91402-01200	NI 11720-10H05

Part Number - 380010-020-02

Belt, Alternator-Fan-Water Pump

▼ OEM Reference

HY 2090051

Part Number - 380101-819

Belt-Fan

▼ OEM Reference

AC 4707731	HY 355150	TY 16374-20100-71
AC 8760137	JU 1408743	TY 89322-76005-71
CL 659886	KO 4948980	YT 056811900
CL 7000354	MZ 484418381	YT 220016975
CL 997412	NI TJF0118381A	YT 220034789
CT 50211566	TC 91367-16150	YT 220042752
CT 50219050	TY 00591-11097-81	YT 220052049
CT 971654	TY 00591-33851-81	YT 449089134
CT A0000-25324	TY 00591-51024-81	YT 580046374
HY 175911	TY 00591-72208-81	YT 900890818
HY 0355150	TY 00591-76336-81	YT 901303863

Part Number - 380010-002-02

Belt-Fan

▼ OEM Reference

AC 4942145	HY 191845	NI 02117-01011
AC 4966574	HY 370411	NI 02117-03011
BK 101286	HY 374011	NI 11720-B1100
BK 9491000624	HY 3000555	NI 11720-B1101
CL 2361378	HY 3051878	NI 11720-L1101
CT 99841	KA 4942145	NI 11720-Y4400
CT 099841	KA 4966574	TC 20801-04261
CT 62923	KO 11720-B1101L	TC 11720-B1101
CT 99481	KO 11720-B1101	TC N-11720-B1101
CT 308302	KO 11720-L1102	TC N-11720-Y4400
CT 347191	LP 156-1001	TY 00591-06238-81
CT 347192	LP 156-13395	TY 00591-07109-81
CT 347196	LP 156-13415	TY 00591-33834-81
CT 0308302	MB 2N159	TY 00591-33846-81
CT 0347191	NI 02117-01011-F1	TY 00591-51009-81
CT 0347192	NI 02117-02011-F1	TY 00591-51010-81
CT 0347196	NI 11720-B1101F1	TY 00591-51014-81
CT 062923	NI 11720-B1101-F1	TY 00591-55397-81
CT 099481	NI 11720-Y4400	
CT 2N0159	NI 20801-04261	

Part Number - 380010-006-02

Belt-Fan

▼ OEM Reference

CL 7000350	LP 156-17415	TY 00591-33843-81
CL 7000353	MB 1039078	TY 00591-33850-81
CT 1039078	MB 91401-09700	TY 00591-33855-81
CT 216256	MB 91401-09800	TY 00591-33880-81
CT 91401-09800	TY 00591-33869-81	TY 00591-42813-81
HY 3000569	TY 00591-55348-81	TY 00591-51025-81
LP 156-1183	TY 16374-32870-71	TY 00591-75169-81
LP 156-16424	TY 00591-10954-81	
LP 156-16631	TY 00591-10963-81	

Belts

Part Number - 380010-009-02

Belt-Fan

▼ OEM Reference

CL 659050	KO 11720-F2700	TY 00591-33877-81
CL 920231	MB 1041623	TY 00591-33879-81
CL 930768	MB MM407440	TY 00591-55359-81
CT 1041623	NI 01978-11004	TY 00591-55375-81
CT 1041823	NI 11720-F2700	TY 00591-74115-81
CT 2W2530	NI 21140-90301	TY 00591-74817-81
CT MM407440	NI CK930768	YT 580035883
DW A273823	TC 20801-04101	YT 220042751
HY 1526079	TC N-02117-00511	

Part Number - 380010-010-02

Belt-Fan

▼ OEM Reference

AC 4860509	HY 123577	TY 99322-01170-71
BK 9265026	HY 0123577	TY 00591-10965-81
CL 448458	JU 14087210	TY 00591-51011-81
CL 774608	KO 4860509	TY 90916-02952-71
CT 971472	LP 156-1182	WM 10A16423
HY 860712	LP 156-13465	YT 220024785
HY 86071	LP 156-16460	YT 220001588
HY 0086071	PM BM-15-1	YT 449089003
HY 111107	TY 90916-02952-71	
HY 0111107	TY 99322-01170	

Part Number - 380030-096

Belt-Fan

▼ OEM Reference

CL 799544	DW D141101	KM 4965293
CT 5M8137	HY 353393	KO 6204-81-3270

Part Number - 380010-013-02

Belt-Fan

▼ OEM Reference

CT 05910-10043	HY 1384008	NI 01978-11134
CT 91801-08600	HY 1457875	NI 19104-K7202
HY 1368841	NI 01978-11104	YT 9013038-36

Part Number - 380010-014-02

Belt-Fan

▼ OEM Reference

CT 91801-07600	HY 1495412	YT 580024157
DW 65.96801-0004	NI 11720-10H06	YT 582011391
HY 108102	TY 16373-30530-71	
HY 1361847	YT 505961521	

Part Number - 380010-012-02

Belt-Fan

▼ OEM Reference

BK LFM8105471	KO 11720-K7201	TY 00591-33863-81
CL 913259	NI 11720-69200	TY 00591-33868-81
CL 3773658	NI 11720-K7201	TY 00591-51008-81
CL 7000351	NI 11720-N9515	TY 00591-55374-81
HY 172895	NI 21067-38800	YT 220002518
HY 233965	NI 21067-K7201	YT 220052061
HY 807004	TY 00591-02732-81	
HY 3051858	TY 00591-07107-81	

Part Number - 380030-212

Belt-Serpentine

▼ OEM Reference

HY 2053666
YT 580034354

Part Number - 380010-008-02

Belt-Timing

▼ OEM Reference

CL 7000659	JU 14364210	TY 00591-34661-81
CT A000000345	JU 14704390	TY 00591-53504-81
HY 1361733	LP 100-FE10	TY 00591-54549-81
HY 3057775	LP 124-1294	YT 220034390
HY 3061901	LP 138-1004	YT 220100725
HY 3115283	MZ FE09-12-205	YT 901294816
JU 147043904	TY 00591-22425-81	YT 901294829

Part Number - 380030-101

Belt-Timing

▼ OEM Reference

CL 7000647	JU 144118105	TY 00591-54055-81
CT 14411810	LP 100-F227	YT 504258756
HY 2028852	LP 124-4003	YT 901577816
JU 1441181	MB 14411810	
JU 14411810	TY 00591-34628-81	

Part Number - 380030-104

Belt-Timing

▼ OEM Reference

CL 918706

Part Number - 380030-179

Belt-Timing

▼ OEM Reference

CL 920294	DW A252036	MB MD197137
CT MD140227		

Part Number - 380010-015-02

Belt-Timing

▼ OEM Reference

HY 1553762
YT 580046902

Part Number - 380010-016-02

Belt-Timing

▼ OEM Reference

HY 1584507
YT 580057187

Part Number - 380010-022-02

Belt-Timing

▼ OEM Reference

HY 411218
YT 582041647



Part Number - 380050-001

Oil Seal

O.D	I.D.	O. Width
100.15 (MM)	69.05 (MM)	9.70 (MM)

▼ OEM Reference
HY 1523530



Part Number - 380060-023

Oil Seal

O.D	I.D.	O. Width
160.00 (MM)	130.00 (MM)	12.00 (MM)

▼ OEM Reference
CT 8C5211 CT 9X7687 DW D700305



Part Number - 380050-002

Oil Seal

O.D	I.D.	O. Width
125.46 (MM)	89.26 (MM)	14.90 (MM)

▼ OEM Reference

CL 7003887 JU 14374480 TY 00591-76873-81
HY 2027701 TY 00591-33124-81 YT 220020044
HY 2027817 TY 00591-54664-81 YT 911086300
JU 1437448 TY 00591-71480-81 YT 920803300



Part Number - 380050-046

Oil Seal

O.D	I.D.	O. Width
105.00 (MM)	80.00 (MM)	13.00 (MM)

▼ OEM Reference

HAM 4940277 HAM 8772429 KO 07012-00080
HAM 4940278 HAM 07012-00080 TC 24843-02051
HAM 4942457 KM 4942457



Part Number - 380050-007

Oil Seal

O.D	I.D.	O. Width
94.90 (MM)	63.27 (MM)	8.08 (MM)

▼ OEM Reference

CL 7003807 JU 14458080 YT 220029615
CT 215416 JU 14473480 YT 220075001
HY 44542 SL S200851 YT 504224218
HY 44542 TY 00591-32069-81
HY 3137615 TY 00591-60402-81



Part Number - 380050-047

Oil Seal

O.D	I.D.	O. Width
52.20 (MM)	41.59 (MM)	7.92 (MM)

▼ OEM Reference

HAM 8779491 KM 4948613
HAM 3EA-22-11210 KO 3EA-22-11210



Part Number - 380050-011

Oil Seal

O.D	I.D.	O. Width
72.50 (MM)	51.20 (MM)	11.40 (MM)

▼ OEM Reference

CT 973851 HY 266733 TY 00591-52483-81
CT 973851 HY 3057503 YT 220037503
HY 153718 TY 00591-20561-81 YT 220075023
HY 153718 TY 00591-32092-81 YT 504224242



Part Number - 380050-048

Oil Seal

O.D	I.D.	O. Width
130.30 (MM)	88.69 (MM)	14.95 (MM)

▼ OEM Reference

AC 4940905 HAM 3EB-21-15130 KM 4940905
HAM 4940905 HAM 3EB-21-15130A KO 3EB-21-15130
HAM 8777919 HAM 3EB-21-15130L



Part Number - 380030-035

Oil Seal

O.D	I.D.	O. Width
68.10 (MM)	57.25 (MM)	8.85 (MM)

▼ OEM Reference

KM 4944592 KO 3EC-21-15140



Part Number - 380030-042

Oil Seal

O.D	I.D.	O. Width
55.14 (MM)	41.05 (MM)	6.9 (MM)

▼ OEM Reference

TY 42125-22000-71 TY 42125-U2100-71



Part Number - 380050-045

Oil Seal

O.D	I.D.	O. Width
60.10 (MM)	46.95 (MM)	7.88 (MM)

▼ OEM Reference

AC 8776236 HAM 3EB-21-15140 KM 8776236
HAM 8776236 KM 4940906 KO 3EB-21-15140



Part Number - 380060-001

Oil Seal

O.D	I.D.	O. Width
105.00 (MM)	75.00 (MM)	15.00 (MM)

▼ OEM Reference

CT 91B33-01100 NI 43090-00H00



Part Number - 380060-002
Oil Seal

O.D	I.D.	O. Width
111.44 (MM)	84.70 (MM)	9.36 (MM)

▼ OEM Reference
HY 1354997 YT 505965509



Part Number - 380050-027
Oil Seal

O.D	I.D.	O. Width
142.30 (MM)	91.58 (MM)	14.34 (MM)

▼ OEM Reference
NI 43090-22H00



Part Number - 380060-003
Oil Seal

O.D	I.D.	O. Width
90.18 (MM)	67.35 (MM)	7.90 (MM)

▼ OEM Reference
HY 325568 YT 504224208



Part Number - 380050-033
Oil Seal, Drive Axle

O.D	I.D.	O. Width
55.00 (MM)	45.00 (MM)	6.00 (MM)

▼ OEM Reference
BK 219990 LI 219990 TY 00591-41351-81
BK 241238 LI 241238 TY 00591-54654-81
CL 7003866 NI 43533-L1100 TY 220054163
HY 3042586 TY 00591-07374-81



Part Number - 380060-004
Oil Seal

O.D	I.D.	O. Width
115.00 (MM)	80.00 (MM)	6.00 (MM)

▼ OEM Reference
CT 6V8407 DW D700581



Part Number - 380050-030
Oil Seal

O.D	I.D.	O. Width
20.10 (MM)	16.00 (MM)	2.35 (MM)

▼ OEM Reference
HY 3025861 TY 00591-07432-81 TY 00591-54658-81
NI 48522-00H00 TY 00591-41385-81 YT 22024966



Part Number - 380060-005
Oil Seal

O.D	I.D.	O. Width
105.12 (MM)	73.83 (MM)	11.90 (MM)

▼ OEM Reference
TY 42415-10480-71



Part Number - 380050-031
Oil Seal

O.D	I.D.	O. Width
39.00 (MM)	27.00 (MM)	3.50 (MM)

▼ OEM Reference
CT 91E43-01800 MB 91E43-01800 NI 48525-FK000



Part Number - 380060-006
Oil Seal

O.D	I.D.	O. Width
100.17 (MM)	78.52 (MM)	12.95 (MM)

▼ OEM Reference
KM 4949337
KO 3EB-22-21160



Part Number - 380060-007
Oil Seal

O.D	I.D.	O. Width
103.84 (MM)	74.68 (MM)	7.80 (MM)

▼ OEM Reference
CT 91E43-02300
NI 40227-FK000



Part Number - 380050-049
Oil Seal

O.D	I.D.	O. Width	I. Width
124.75 (MM)	57.05 (MM)	7.5 (MM)	12.80 (MM)

▼ OEM Reference
AC 8761245 HAM 3EB-21-32180 KO 3EB-21-32180
HAM 8761245 KM 8761245



Part Number - 380060-008
Oil Seal

O.D	I.D.	O. Width
145.11 (MM)	109.27 (MM)	15.80 (MM)

▼ OEM Reference
KM 8765021
KO 8765021
KO 3EC-21-36250



Part Number - 380060-009

Oil Seal

O.D	I.D.	O. Width
105.14 (MM)	37.85 (MM)	9.87 (MM)

▼ OEM Reference
TY 42415-11630-71



Part Number - 380060-015

Oil Seal

O.D	I.D.	O. Width
62.00 (MM)	85.00 (MM)	12.00 (MM)

▼ OEM Reference
CT 9X7695
DW D700306



Part Number - 380060-010

Oil Seal

O.D	I.D.	O. Width
53.19 (MM)	41.26 (MM)	6.70 (MM)

▼ OEM Reference
TY 42125-23320-71



Part Number - 380060-016

Oil Seal

O.D	I.D.	O. Width
95.13 (MM)	69.42 (MM)	12.66 (MM)

▼ OEM Reference
MB 93433-12400



Part Number - 380060-011

Oil Seal, Steer Axle

O.D	I.D.	O. Width
21.00 (MM)	17.00 (MM)	2.75 (MM)

▼ OEM Reference
MB 91A43-02300
NI 48522-FJ101



Part Number - 380060-017

Oil Seal

O.D	I.D.	O. Width
47.00 (MM)	38.00 (MM)	10.00 (MM)

▼ OEM Reference
NI 43252-J2000



Part Number - 380060-012

Oil Seal

O.D	I.D.	O. Width
114.43 (MM)	78.09 (MM)	16.76 (MM)

▼ OEM Reference
CL 2786180



Part Number - 380060-018

Oil Seal

O.D	I.D.	O. Width
130.50 (MM)	95.25 (MM)	22.70 (MM)

▼ OEM Reference
CL 245020



Part Number - 380060-013

Oil Seal

O.D	I.D.	O. Width
90.22 (MM)	57.75 (MM)	10.67 (MM)

▼ OEM Reference
HY 2021557
KM 4940496
KO 3EA-21-14140
YT 921949300



Part Number - 380060-019

Oil Seal

O.D	I.D.	O. Width
110.00 (MM)	70.00 (MM)	13.00 (MM)

▼ OEM Reference
KO 3EA-21-14131
KM 4940495



Part Number - 380060-014

Oil Seal

O.D	I.D.	O. Width
115.00 (MM)	90.00 (MM)	13.00 (MM)

▼ OEM Reference
HY 300801
YT 50595912



Part Number - 380030-145

Oil Seal

O.D	I.D.	O. Width
110.22 (MM)	74.56 (MM)	13.25 (MM)

▼ OEM Reference
HY 2021554
YT 920802300

Seals



Part Number - 380060-021

Oil Seal

O.D	I.D.	O. Width
80.10 (MM)	56.46 (MM)	11.90 (MM)

▼ OEM Reference
HY 2021898
YT 958506995



Part Number - 380060-024

Oil Seal

O.D	I.D.	O. Width
82.23 (MM)	58.61 (MM)	11.80 (MM)

▼ OEM Reference
MB 91B33-02700
NI 43254-FJ100



Part Number - 380103-979

Oil Seal

O.D	I.D.	O. Width
120.12 (MM)	91.95 (MM)	12.15 (MM)

▼ OEM Reference
TY 42415-22800-71



Part Number - 380060-025

Oil Seal

O.D	I.D.	O. Width
88.25 (MM)	57.57 (MM)	6.80 (MM)

▼ OEM Reference
TY 43821-22000-71



Part Number - 380060-022

Oil Seal, Steel Axle

O.D	I.D.	O. Width
33.00 (MM)	25.00 (MM)	4.00 (MM)

▼ OEM Reference
HY 2026739
YT 906150100



Part Number - 380060-026

Oil Seal

O.D	I.D.	O. Width
96.00 (MM)	64.75 (MM)	8.30 (MM)

▼ OEM Reference
KO 3EB-24-41330



Part Number - 380104-004

Oil Seal

O.D	I.D.	O. Width
103.00 (MM)	51.80 (MM)	8.30 (MM)

▼ OEM Reference
CT 91233-07900
MB 91233-07900



Part Number - 380060-020

Dust Seal

O.D	I.D.	O. Width
34.99 (MM)	25.13 (MM)	5.82 (MM)

▼ OEM Reference
MB 91444-11400
NI 48525-FJ100



Part Number - 380103-969

Oil Seal

O.D	I.D.	O. Width
93.85 (MM)	59.61 (MM)	7.50 (MM)

▼ OEM Reference

CL 7003865	MB 91B43-02300	TC 40227-04H00
CT 214765	NI 32404	TY 00591-07354-81
CT 91B43-02300	NI 40227-02K00	TY 00591-41350-81
HY 3046730	NI 40227-04H00	TY 00591-54653-81
MB 214765	NI 40227-04K00	YT 220070983



Part Number - 380104-026

Oil Seal - Rear

O.D	I.D.	O. Width
110.30 (MM)	90.20 (MM)	8.74 (MM)

▼ OEM Reference

CL 447599	HY 76001421	TY 00591-41400-81
CL 7003892	MZ F802-11-399	TY 00591-54676-81
CT 14364040	TC T-F802-11-399	TY 00591-60150-81
HY 1361691	TY 00591-22412-81	YT 220100689
HY 3057772	TY 00591-22424-81	YT 900889814
HY 324772	TY 00591-41372-81	YT 901292814



Part Number - 380103-941

Oil Seal

O.D	I.D.	O. Width
90.15 (MM)	63.78 (MM)	12.75 (MM)

▼ OEM Reference

HY 2028621	YT 2028621
HY 4615139	YT 929261300



Part Number - 380104-009

Oil Seal

O.D	I.D.	O. Width
95.13 (MM)	69.42 (MM)	12.66 (MM)

▼ OEM Reference

CT 91E33-01800	MB 91E33-01800	TY 800144064
HY 800144064	NI 43254-FK000	



Part Number - 380006-013-01
Transmission Charging Pump

▼ OEM Reference
KO 30B-13-11200



Part Number - 380001-014-02
Torque Converter (Brand New)

▼ OEM Reference
HAM 30B-13-11110
KO 30B-13-11110



Part Number - 380001-022
Torque Converter

▼ OEM Reference
KO AS351200-13020
KO DC6A26500000



Part Number - 351096-120
Strainer & Cup

▼ OEM Reference

BR 31728-FJ10B	CT 91A2408201	MB 91A2408200
CT 50443383	JU 50443383	MB 91A2408201
CT 91A24-08200	MB 50443383	NI 31728-FJ10B
CT 91A24-08201	MB 91A24-08200	
CT 91A2408200	MB 91A24-08201	



Part Number - 380030-079
Solenoid Valve

▼ OEM Reference
CT 31765-FC000
CT 93A28-01400
MB 93A28-01400
NI 31765-FC000



Part Number - 380030-001
Accelerator Unit

▼ OEM Reference

AC 8772287	HAM 18919-AM810	NI 18919-AM810
CT 91A51-08400	KM 8772287	
HAM 8772287	KO 18919-AM810	



Part Number - 380030-027

Valve Cover Gasket H20, H25 & H20II

▼ OEM Reference
DW D491287
KM 4942234
NI 13270-E3400



Part Number - 380030-061

Valve Cover Gasket 3.0L

▼ OEM Reference
CL 925017 TY 11214-U2120-71
DW A218625 YT 580000617
HY 388323



Part Number - 380030-028

Valve Cover Gasket K15, K21 & K25

▼ OEM Reference
CT 91H20-06510 HAM13270-FY500
HAM8772239 HAM13270-FY50A
HAM8777419 NI 13270-FY50A



Part Number - 380030-029

Valve Cover Gasket 4G63 & 4G64

▼ OEM Reference
CL 930135
DW A218023
MB MD130494



Part Number - 380030-062

Valve Cover Gasket FE & F2

▼ OEM Reference
HY 1360886
YT 901290811



Part Number - 380030-327

Valve Cover Gasket PSI 2.0 & 2.4L

▼ OEM Reference
HY 4111673
YT 582041407



Part Number - 380030-033

Head Gasket - For LPG Engines K21 & K25

▼ OEM Reference
CT 91H20-00370
NI 11044-FU460



Part Number - 380030-067

▼ OEM Reference

CT 91H20-00360
NI 11044-FU400

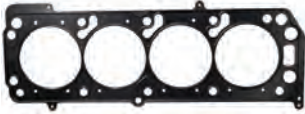

Part Number - 380030-227
**Head Gasket
 2.4L**
 ▼ OEM Reference
 HY 1584141
 YT 580056984



Part Number - 380030-034
**Manifold Gasket
 K21 & K25**
 ▼ OEM Reference
 CT 91H20-01740
 MB 14035-FY500



Part Number - 380106-018
Valve Stem Seal

▼ OEM Reference

CL 447597	JU 14417150	TY 00591-41308-81
CT 14417150	JU 14364360	TY 00591-53754-81
CT A0000-25696	MB 14417150	TY 00591-76787-81
HY 1361718	NI T4786-10155	YT 76001434
HY 1361719	NI THE19-10155	YT 901290837
HY 3056228	TC FE01-23-20010	YT 220036489
HY 76001433	TC T4786-10155	YT 901274801
HY 76001434	TC THE19-10155	YT 901293847



Part Number - 380030-122
Valve Assembly
 ▼ OEM Reference
 CT 91H20-04460
 HM 17962-FU460
 KO 8774026
 KO 17962-FU460
 NI 17962-FU460



Part Number - 380030-229
**Intake Valve
 K21 & K25**
 ▼ OEM Reference
 CT 91H20-01350
 KO 13201-FY500
 MB 91H20-01350
 NI 13201-FY500



Part Number - 380030-036
PCV Valve

▼ OEM Reference

CT 91H20-00480	NI 11810-75T00	TY 12204-76014-71
HY 1360893	TC 212T1-09141	YT 901290819



Part Number - 380104-091
PCV Valve

▼ OEM Reference

HY 1553692	YT 580046873
YT 1553692	



Part Number - 380030-117
Oil Pressure Switch

▼ OEM Reference
 KM 4942519
 KO YM114250-39450
 NI 25240-89902
 NI 25240-89910



Part Number - 380050-032
Oil Pressure Switch

▼ OEM Reference

CL 920227	KM 4920089	TC 25240-FJ10A
CL 920441	KM 4968878	TC T-B366-18-501
CT 31A90-00300	KO 25240-FJ10A	TY 83530-76005-71
CT 90425-00390	MB 31A90-00300	TY 83530-78202-71
CT MC840219	MB 90425-00390	TY 83530-U2120-71
CT MD138993	MB MC840219	TY 83530-UC010
DOS A218441	MB MD138993	TY 83530-UC010-71
HY 1360086	NI 25240-FJ10A	YT 901860807
HY 2026608	NI 25240-FM00A	



Part Number - 380030-040
Crankshaft Sensor

▼ OEM Reference
 NI 23731-6J906



Part Number - 380104-928
Camshaft Sensor

▼ OEM Reference

CT 91H20-21170	KO 8779379	KO 23731-6N21A
KO 23731-6N20C	KO 8780027	NI B3731-6N20C
KO 8772279	KO B3731-6N20C	



Part Number - 380030-209
Oil Pressure Sensor

▼ OEM Reference
 HY 1566654
 YT 580051890



Part Number - 380030-041
Oxygen Sensor

▼ OEM Reference
 CT 91A62-03500
 NI 22690-FU460

Drive Train



Part Number - 380030-171

Oxygen Sensor

▼ OEM Reference
TY 17410-26600-71



Part Number - 380030-284

Sensor, Accelerator

▼ OEM Reference
TY 57510-26600-71



Part Number - 380030-219

Oxygen Sensor

▼ OEM Reference

CT	93721-06600	HY	1646456	YT	580076752
HN	E1799102	MB	93721-06600		



Part Number - 380101-097

Clutch Cover

▼ OEM Reference
KO 3EB-10-11510
KO 3EA-10-14130
KO 3EB-10-21610
CT 91221-05010



Part Number - 380030-215

Map Sensor

▼ OEM Reference
NI 22680-FU460



Part Number - 380030-216

V Belt Tensioner

▼ OEM Reference

HY	2067631	HY	4019125	YT	580073942
HY	2090303	YT	580048921	YT	582007582



Part Number - 380030-232

Map Booster Sensor

▼ OEM Reference
HY 1548352
YT 580045523



Part Number - 380001-025

Tensioner Pulley

▼ OEM Reference
HY 2029098

Front \ Back view



Part Number - 380030-330

Sensor - Temperature Coolant

▼ OEM Reference
HY 1515654
YT 580036023



Part Number - 380051-009

Switching Module

▼ OEM Reference
CT 91A20-01100
NI 22710-FU460
NI 2G277-6NF00



Part Number - 380030-107

Ignition Module

▼ OEM Reference
HY 1326536
KM 4968820
NI 22020-G5111
YT 901953809



Part Number - 380030-274

Dipstick

▼ OEM Reference
TY 32604-26610-71



Part Number - 380030-011

Bolt

▼ OEM Reference

AC 4941509	HAM 34A-24-11220	KO 34A-24-11220
HAM 4941509	KM 4941509	



Part Number - 380100-011

Accelerator Cable

▼ OEM Reference

BK LA1003837001	JU 144150208	TY 00591-55813-81
CL 7001112	LI LA1003837001	TY 00591-55825-81
CT 14415020	MB 14415020	YT 144150208
CT A0000-10391	MB A0000-10391	YT 220037736
HY 2021429	TY 00591-22441-81	YT 911851401
HY 3057736	TY 00591-30313-81	YT 911851402
HY 3065605	TY 00591-35479-81	YT 919512401
HY 3065807	TY 00591-53465-81	
JU 14415020	TY 00591-55812-81	



Part Number - 380030-012

Bolt

▼ OEM Reference

AC 300-27-13251	HAM 4941592	KO 300-27-13251
AC 34B-24-11220	HAM 34B-24-11221	KO 34B-24-11220
AC 4941592	KM 4941592	
CL 444932	KO 34B-24-11221	



Part Number - 380030-013

Bolt

▼ OEM Reference

AC 4949338	HAM 3EB-22-21170	KO 3EB-22-21170
HAM 4949338	KM 4949338	



Part Number - 380030-338

Reservoir Cap

▼ OEM Reference

CT 2I7218	MB 2I7218	TY 47230-76001-71
HY 3041805	TY 00591-71425-81	YT 220011562
HY 3061805	TY 47230-20030-71	



Part Number - 380030-109

Bolt

▼ OEM Reference

HY 118714
YT 504226246



Part Number - 380030-110

Bolt, Tie Rod

▼ OEM Reference

KM 4949361
KO 3EB-24-21581



Part Number - 380030-194

Post, Overhead Guard (LH, Rear)

▼ OEM Reference

NI 73761-FW70A



Part Number - 380030-195

Post, Overhead Guard (RH, Rear)

▼ OEM Reference

NI 73760-FW70A



Part Number - 380030-014

Bolt, Tie Rod

▼ OEM Reference

KM 8761511
KO 3EB-24-35130



Part Number - 380030-015

Bolt, Tie Rod

▼ OEM Reference

KM 8761509
KO 3EB-24-35140



Part Number - 380030-150

Anchor Bolt

▼ OEM Reference

HY 1369357
YT 518801644



Part Number - 380030-105

Bolt, Tie Rod

▼ OEM Reference

KM 8764087
KO 8764087
KO 3EC-24-31690
KO 3ED-24-41270



Part Number - 380030-066

Pin, Tie Rod

▼ OEM Reference
TY 43731-23442-71



Part Number - 380050-029

Bolt

▼ OEM Reference
CL 445458 TC 43225-L1300
NI 43225-L1300 TY 80114-76006-71



Part Number - 380030-050

Bolt

▼ OEM Reference
HY 2027593
HY 2037408
YT 903758300



Part Number - 380100-599

Bolt

▼ OEM Reference
HY 1509870
YT 580036619



Part Number - 380030-139

Bolt

▼ OEM Reference
CL 7003323
HY 2021798
YT 900525100



Part Number - 380030-135

Cylinder Head Bolt

▼ OEM Reference
NI 1G118-6TC00
NI 11056-FY500
NI 11056-FY50A



Part Number - 380030-250

Bolt, Upper Pin

▼ OEM Reference
YT 272106000



Part Number - 380030-238

Cylinder Head Bolt

▼ OEM Reference
HY 1584206
YT 580057036



Part Number - 380030-146

Bolt

▼ OEM Reference
CL 7003288
HY 339529
YT 505972584



Part Number - 380030-052

Tie Rod Pin

▼ OEM Reference
HY 2021793 SY HY2021793 YT YT911982300
HY HY2021793 YT 911982300



Part Number - 380030-051

Bolt

▼ OEM Reference
HY 1502276 YT 580061342
HY 2027595 YT 903775300



Part Number - 380030-149

Tie Rod Pin

▼ OEM Reference
HY 1568271
HY 326498
YT 580052360



Part Number - 380030-089

Bolt, Tie Rod

▼ OEM Reference
KM 4949344
KO 3EB-24-A2570



Part Number - 380030-249

Pedal - Dowel Pin

▼ OEM Reference
CT F2850-05016
MB F2850-05016



Part Number - 380030-055

Bolt

▼ OEM Reference
KM 4949328
KO 3EB-21-25170



Part Number - 380030-093

Tie Rod Pin

▼ OEM Reference
TY 43731-13311-71
TY 43731-13360-71

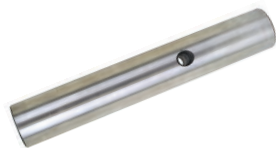

Part Number - 380030-115

King Pin

▼ OEM Reference

CT 6R6961
DW D700576

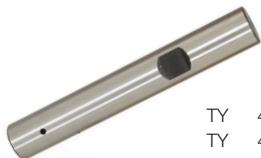

Part Number - 380030-103

King Pin

▼ OEM Reference

TY 43232-9NML8-71 TY 43232-U3270-71
TY 43232-U2170-71 TY 43232-U3271-71



Part Number - 380030-335

King Pin, Steering Knuckle (RH)

▼ OEM Reference

TY 43231-U2260-71



Part Number - 380030-197

Chain Anchor Pin

▼ OEM Reference

HY 323161
YT 504071777



Part Number - 380030-242

Chain Anchor Pin

▼ OEM Reference

HY 147485 YT 517056800
HY 161005 YT 519686300
YT 504242207



Part Number - 380030-088

King Pin Repair Kit

▼ OEM Reference

TY 04432-10100-71 TY 04432-U1030-71
TY 04432-10120-71 TY 04432-U2020-71
TY 04432-20061-71 TY 04432-U2021-71
TY 04432-20080-71



Part Number - 380030-165

King Pin Repair Kit

▼ OEM Reference

TY 04432-U1010-71



Part Number - 380030-037

Steer Link Pin

▼ OEM Reference

CT 908169
DW D700583



Part Number - 380030-169

Tie Rod Pin

▼ OEM Reference

TY 43741-U2100-71

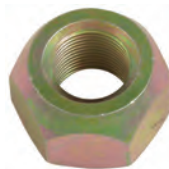

Part Number - 380030-016

Nut

▼ OEM Reference

AC 4941586 HAM 34B-21-14151 KO 34B-21-14151
HAM 4941586 KM 4941586



Part Number - 380030-017

Nut

▼ OEM Reference

CT F2335-16000 KO 01593-31613 NI 08911-0461A
KM 8761510 NI 08911-04610 TY 90171-16001-71



Part Number - 380030-065

Nut

▼ OEM Reference

KM 4940132
KO 01582-11815



Part Number - 380030-018

Nut

▼ OEM Reference

AC 4941345 HY 2303412 NI 43224-04H000
CT 64343-19900 KM 4941345 TC 23654-34051
HAM 4941345 KO 300-22-31241 TC 43224-04H000
HAM 300-22-31240 NI 40224-0T005 TY 80942-76005-71
HAM 300-22-31241 NI 40224-FJ100 TY 90179-14001-71
HY 2021593 NI 40224-07D0B TY 900126308



Part Number - 380030-080

Nut

▼ OEM Reference

TY 90179-14002-71



Part Number - 380030-019

Nut

▼ OEM Reference

AC 4944661 HY 1374550 TY 90179-12003-71
CT 05634-01200 HY 2021595 TY 94186-11200-71
CT 91446-04300 KM 4944661 YT 580003984
HAM 4944661 KO 3EC-30-11490 YT 901202809
HAM 3EC-30-11490 TC 271F6-42531 YT 912471303
HY 1312624 TC 44217-22H00
HY 1360799 TY 84186-76001-71

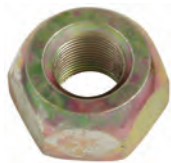

Part Number - 380030-102

Nut

▼ OEM Reference

KO 4944952 KO 310-30-26310 KO 3EC-21-36811
 KO 8771656 KO 3EC-21-36810



Part Number - 380030-143

Nut

▼ OEM Reference

HY 2021799 TC 22513-72011 TY 90179-12004-71
 KM 4941745 TY 80942-76002-71 YT 900126301
 KO 358-27-11230



Part Number - 380030-116

Nut, Castle

▼ OEM Reference

KM 4940141 KO 8764088 KO 01593-11813
 KO 4940141 KO 8771486 KO 01593-31813
 KO 4972207



Part Number - 380030-020

Plate

▼ OEM Reference

HAM 4940458 HAM 3EA-15-11180A KM 4940458
 HAM 3EA-15-11180 HAM 3EA-15-11180L KO 3EA-15-11180



Part Number - 380030-030

Washer

▼ OEM Reference

TY 43755-23440-71



Part Number - 380030-021

Shim

▼ OEM Reference

KM 4941505 KO 34A-24-11150
 KM 4941506 KO 34A-24-11160



Part Number - 380030-022

Shim

▼ OEM Reference

AC 4941755 HAM 360-27-11220 KO 360-27-13280
 HAM 4941755 KM 4941755 TY 90564-28002-71
 HAM 4968320 KO 360-27-11220



Part Number - 380030-246

Shim

▼ OEM Reference
 KO 3EB-73-A5390



Part Number - 380030-141

Retainer

▼ OEM Reference

NI 48594-FJ100
 MB 91444-11300



Part Number - 380030-142

Washer

▼ OEM Reference

HY 300752
 YT 505972590



Part Number - 380030-239

Washer

▼ OEM Reference

KO 3EB-24-A7940



Part Number - 380030-248

Lockwasher

▼ OEM Reference

AC CC688705
 KO CC688705



Part Number - 380030-026

Steer Axle Bushing

▼ OEM Reference

HAM 4941532 HAM 34A-42-11411A KO 34A-42-11411
 HAM 4941533 HAM 34A-42-11411L
 HAM 34A-42-11411 KM 4941533



Part Number - 380030-155

Steer Axle Bushing

▼ OEM Reference

CT 91E43-05500
 MB 91E43-05500



Part Number - 380030-049

Steer Axle Bushing

▼ OEM Reference

HY 2021794
 YT 911983300



Part Number - 380030-136
Bushing

▼ OEM Reference
NI 49534-FJ101



Part Number - 380050-008
O-Ring

▼ OEM Reference
CL 39678 HY 39678
CT 05500-31070 MB 05500-31070
HY 39677 YT 504225236



Part Number - 380030-206
Bushing

▼ OEM Reference
KO 3EB-24-A7910



Part Number - 380030-183
Exhaust Gasket Ring

▼ OEM Reference
TY 90584-43001-71



Part Number - 380030-243
Mast Bushing

▼ OEM Reference
KO 3EA-71-31291



Part Number - 380030-070
Steering Link

▼ OEM Reference
TY 43751-23440-71



Part Number - 380030-087
Collar

▼ OEM Reference
TY 43735-13310-71



Part Number - 380030-071
Steering Link

▼ OEM Reference
TY 43752-23442-71



Part Number - 380030-097
Collar

▼ OEM Reference
TY 43735-23440-71



Part Number - 380030-138
Steering Link

▼ OEM Reference
CT 91B43-10500
NI 48511-FJ101



Part Number - 380030-241
Spacer

▼ OEM Reference
HY 366115
YT 504235278



Part Number - 380030-173
Steering Link

▼ OEM Reference
MB 93E43-00500
NI 48512-FL100



Part Number - 380030-092
Grease Fitting

▼ OEM Reference
TY 86456-76002-71



Part Number - 380030-222
Steering Link (RH)

▼ OEM Reference
KO 3EB-25-35120



Part Number - 380102-150
Grease Fitting

▼ OEM Reference

AC 307-807-1850	CL 926251	KO 4941508
AC 4941508	KM 4941508	NI 08932-30210
BR 08932-30210	KO 307-807-1850	TC 08932-30210



Part Number - 380030-225
Steering Link (LH)

▼ OEM Reference
KO 3EB-25-35110



Part Number - 380030-174

Steering Link

- ▼ OEM Reference
- TY 43752-13310-71
- TY 43752-13360-71
- TY 43752-16640-71



Part Number - 380030-175

Steering Link

- ▼ OEM Reference
- TY 43753-13311-71



Part Number - 380030-176

Steering Link

- ▼ OEM Reference
- TY 43751-13311-71
- TY 43751-13360-71



Part Number - 380030-177

Steering Link

- ▼ OEM Reference
- HY 381298
- YT 505972530



Part Number - 380030-156

Connecting Link

- ▼ OEM Reference
- SY BL1034-CL



Part Number - 380030-157

Connecting Link

- ▼ OEM Reference
- SY BL623-CL



Part Number - 380101-258

Connecting Link

▼ OEM Reference

- | | | |
|----------------|-------------|----------------|
| CT 0367163 | CT NA013216 | MB A0000-28204 |
| CT 1144528 | HY 3068751 | MB GS00-00976 |
| CT 367163 | MB 0367163 | MB NA013216 |
| CT A0000-28204 | MB 1144528 | RA 681-847 |
| CT GS00-00976 | MB 367163 | |



Part Number - 380030-121

Tie Rod End

- ▼ OEM Reference
- HY 185870
- YT 504224200
- YT 504224219



Part Number - 380030-078

Tie Rod End

- ▼ OEM Reference
- NI 48520-10H04



Part Number - 380030-178

Tie Rod End

- ▼ OEM Reference
- NI 48520-00H04



Part Number - 380030-217

Tie Rod End

- ▼ OEM Reference
- KO 3EB-24-A7920



Part Number - 380030-218

Tie Rod End

- ▼ OEM Reference
- KO 3EB-24-A7930



Part Number - 380030-140

Tie Rod Pin

- ▼ OEM Reference
- NI 48513-FJ100
- NI 48513-FJ10B



Part Number - 380030-224

Tie Rod Pin

- ▼ OEM Reference
- KO 3EB-24-51281
- KO 3EB-25-A7171



Part Number - 380104-143

Tie Rod Pin

▼ OEM Reference

- | | |
|----------------|----------------|
| CT 91444-10700 | MB 91444-10700 |
| CT 91A43-10700 | MB 91A43-10700 |



Part Number - 380030-291
Cap - Sub-Assembly - Air

▼ OEM Reference
TY 17704-U2230-71



Part Number - 380030-054
Hub Cap

▼ OEM Reference
KM 8772430
KO 3EB-24-11160



Part Number - 380102-318
Hub Cap

▼ OEM Reference
HY 2021800 YT 900003100
JU 14101710 YT 922363300
JU 14474150



Part Number - 380030-056
Hood Hinge

▼ OEM Reference
KO 3EB-50-31271



Part Number - 380030-082
Solenoid

▼ OEM Reference
TA 72-501-43



Part Number - 380030-083
Hose - sheave

▼ OEM Reference
HY 1494017



Part Number - 380030-201
Hose - sheave

▼ OEM Reference
HY 1343989
YT 504064782



Part Number - 380030-290
Hose - sheave
4.3999" OD x .7490"

▼ OEM Reference
CL 448821 MB A0000-10938 TY 68855-25150-71
CT A0000-10938 TY 00591-72014-81 YT 220022101
HY 3127445 TY 68804-25080-71



Part Number - 380030-118
Plug

▼ OEM Reference
HY 109169 KO 07046-13520 YT 012156900
HY 1194451 NI 00933-33500
KM 4940295 TY 80330-76010-71



Part Number - 380030-148
Plug

▼ OEM Reference
KO 07046-14020
YT 959100911



Part Number - 380030-170
Plug

▼ OEM Reference
HY 185860
YT 504224266



Part Number - 380030-147
Muffler Cushion

▼ OEM Reference
KO 3EB-03-31140
NI 20638-61500
TC 22252-32241A



Part Number - 380030-112
Gas Spring

▼ OEM Reference
CT 91312-02900
MB 93113-09600
NI 65320-FB401



Part Number - 380030-159
Gas Spring

▼ OEM Reference
AC 4966556 HAM8761692 KM 8761692
HAM3EB-50-A5110 HAM8772331 KO 3EB-50-A5111
HAM3EB-50-A5111 HM 3EB-50-A5111



Part Number - 380030-199

Gas Spring

▼ OEM Reference
HY 1563497
YT 580056664



Part Number - 380030-210

Gas Spring

▼ OEM Reference
KO 3EB-50-41150



Part Number - 380030-337

Gas Spring, Hood Cover (LH)

▼ OEM Reference
HY 4011435
YT 582004571



Part Number - 380030-032

Horn Kit Cup

▼ OEM Reference
TY 45122-23600-71



Part Number - 380030-106

Horn Button

▼ OEM Reference
TY 45121-U2100-71



Part Number - 380030-208

Horn Button

▼ OEM Reference
NI 48422-GD80A



Part Number - 380102-254

Horn Button

▼ OEM Reference
TY 45121-12471-71
TY 45121-12472-71



Part Number - 380030-325

Horn Button

▼ OEM Reference
HY 1347135



Part Number - 380030-213

Horn Pad

▼ OEM Reference
KO 3EB-33-41130



Part Number - 380030-223

Horn Cover

▼ OEM Reference
KO 3EB-33-31240



Part Number - 380030-326

Contact Set, Horn

▼ OEM Reference
YT 580049812



Part Number - 380030-275

Hose - Oil Cooler

▼ OEM Reference
TY 32999-23330-71



Part Number - 380030-094

Plate, Steer Axle

▼ OEM Reference
TY 43237-13310-71



Part Number - 380030-153

Bracket/Guard

▼ OEM Reference
HY 1354105
YT 580000118



Part Number - 380030-204

Bracket/Guard

▼ OEM Reference
NI 26311-FB00A
NI 26311-FV00A



Part Number - 380030-181

Battery Terminals (Top)

▼ OEM Reference
HM 53710



Part Number - 380030-323

Switch Assembly, Directional Control

▼ OEM Reference
TY 57460-23331-71



Part Number - 380030-207

Relay

▼ OEM Reference
CT 91A04-11700
KO 3EB-55-41450
MB 91A04-11700
NI 25230-GE00A



Part Number - 380030-261

Directional Switch

▼ OEM Reference
CT A0000-14969
MB A0000-14969
TY 57460-23330-71

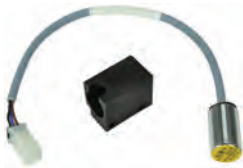

Part Number - 380051-003

Brake Switch

▼ OEM Reference
HY 2077505
YT 524228854



Part Number - 380051-008

Turn Signal Switch

▼ OEM Reference
CT 91A05-13400
MB 91A05-13400
NI 25541-FK000



Part Number - 380051-004

Stop Light Switch

▼ OEM Reference
KM 34B-55-15230
KM 4941704
KO 34B-55-15230



Part Number - 380105-520

Switch, Forward/Reverse

▼ OEM Reference
CT 91306-45200
CT 91406-42800
CT 97C41-21900
CT 97C41-31500
MB 91306-45200
MB 91406-42800
MB 97C41-21900
MB 97C41-31500



Part Number - 380051-005

Stop Lamp Switch

▼ OEM Reference
NI 25320-GB000



Part Number - 380051-006

Directional Switch

▼ OEM Reference
CT 91A05-75020
MB 91A05-75020
NI 25560-FK20A



Part Number - 380030-282

Relay

▼ OEM Reference
ND 056800-2440-RPL
ND 587005370
TY 57410-30530-71



Part Number - 380030-322

Switch Assembly, Directional Control

▼ OEM Reference
TY 57460-26631-71

Miscellaneous



Part Number - 380030-221

Knuckle (LH)

▼ OEM Reference
 KO 3EB-24-51222
 KO 3EB-24-53222



Part Number - 380102-821

Knuckle (RH)

▼ OEM Reference
 HY 1464149
 YT 580011755



Part Number - 380030-231

Knuckle (RH)

▼ OEM Reference
 AC 3EB-24-51212
 KO 3EB-24-53212



Part Number - 380030-233

Panel Assembly

▼ OEM Reference
 NI 65261-FK102



Part Number - 380102-814

Knuckle (LH)

▼ OEM Reference
 TY 43212-23470-71
 TY 43212-23471-71



Part Number - 380030-240

Insulator

▼ OEM Reference
 KO 3EB-33-31160



Part Number - 380102-835

Knuckle (RH)

▼ OEM Reference
 CL 449310
 CT A000025847
 MB A000025847
 TY 43211-13311-71
 TY 43211-13312-71
 TY 43211-23470-71
 TY 43211-23471-71
 TY 43211-F1101-71
 TY 43211-F1102-71
 TY 43251-F1100-71



Part Number - 380030-245

Hydraulic Filter

▼ OEM Reference
 TY 67502-26600-71
 TY 67502-U2230-71

Section 6

Work Assist®

Contents

Work Assist® Accessories Application Chart	6.02
Work Assist® Accessories	6.03
RAM Mounts	6.09
Camera Systems	6.13
Camera Kits	6.15
Fork Level Indicator	6.16
Fork Laser Guidance System	6.16
QuickPick® Remote	6.19
Forklift Covers & Enclosures	6.19

Note: 1910.178(q)(5) (1998) of the Occupational Safety and Health Act (OSHA) requires that "All parts of any such industrial truck requiring replacement shall be replaced only by parts equivalent as to safety with those used in the original design."

The installation onto a lift truck of non-certified electronic components may invalidate a truck's UL EE or LPS listing and could pose a safety risk. Customers with UL-listed lift trucks are solely responsible for ensuring compliance with UL for field modifications. The selection of non-OEM parts is made solely by the customer with the awareness that OEM parts are available. Crown Equipment Corporation is unaware of what testing and/or certification, if any, the non-OEM parts have undergone and disclaims all warranties and representations regarding any non-OEM part.





Work Assist[®]

Accessories & Options

Crown knows a clean, organized work environment means increased operator productivity. That's why Crown offers **Integrated Truck Solutions** that are designed to make the operator's job faster, easier, and more productive.



Clip Pad



Clip Pad and Hook



Shrink Wrap Holder



Storage Pocket



Shrink Wrap Tray



Cup Holder



Storage Net



WORK ASSIST[®]

Work Assist Accessories & Options*	Aftermarket Kit Numbers	RC	SC	FC	SP	RM	RR	RD	PE	PR	C-5**
Accessory Clamp (Includes Hardware)	130145	•	•	•	•	•	•	•	•	•	•
Shrink Wrap Holder (Includes Clamps & Hardware)	145080	•	•	•	•	•	•	•	•	•	•
Hook (Includes Clamp & Hardware)	131419	•	•	•	•	•	•	•	•	•	•
Clip Pad and Hook (Includes Clamp & Hardware)	130144	•	•	•	•	•	•	•	•	•	•
Clip Pad (Includes Clamp & Hardware)	131415	•	•	•	•	•	•	•	•	•	•
Cup Holder (Includes Clamp & Hardware)	145078	•	•	•	•	•	•	•	•	•	•
Storage Pocket (Includes Clamp & Hardware)	130868	•	•	•	•	•	•	•	•	•	•
Shrink-Wrap Tray	131379	na	na	na	na	na	na	na	•	•	na
Storage Net Behind Seat	147005S	na	na	na	na	na	na	na	na	na	•
PE/PR - Accessory Pole (Includes Hardware)	131380										
PE/PR - Accessory Pole Extension (Includes Hardware)	131381										
SP - Accessory Pole (Includes Hardware)	130879										
RR/RD - Accessory Pole (Includes Clamp & Hardware)	131416										
RR/RD - Accessory Pole (Includes Bracket & Hardware)	131414										
RC - Accessory Pole (88.0" OHG)	141296-002										
RC - Accessory Pole (84.5" OHG)	141296-001										

* Some products may require the use of a Work Assist accessories pole for the installation of Crown's Work Assist Options.

** C-5 Cushion products only.

Mounting

Tubes

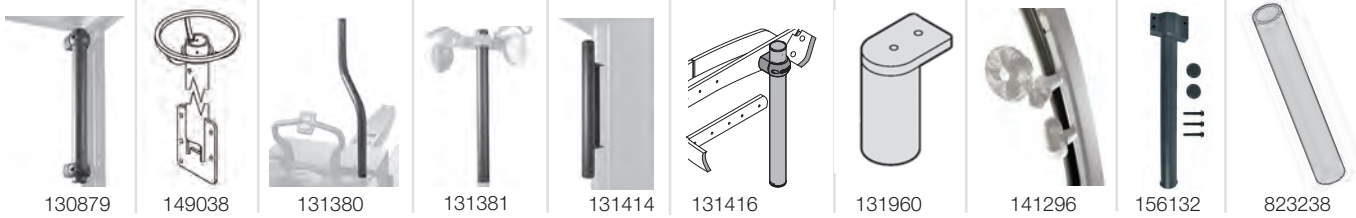

Part No.	Description	Model
130879	Accessory Rail Kit LH or RH	SP 3000 Series
149038	Work Assist Pole	PC 4500
131380	Standard Work Assist Tube Kit	PE 4000 Series
131381	Work Assist Tube Extension Kit	PE/PR 4000 Series
143680	Standard Work Assist Tube Kit; Note: Electrical kit is P.N. 143681	PR 4500
131414	Right Tube Assembly Kit	RR/RD 5000/S Series
131416	Work Assist Tube Kit	RR/RD 5000/S Series

Part No.	Description	Model
131960-001	TT Mast	ST/SX 3000
131960-002	TL Mast	ST/SX 3000
131960-003	TL Mast	ST/SX 3000
141296-001	84.5" Work Assist Tube Kit	RC 5500
141296-002	88" Work Assist Tube Kit	RC 5500
156132	Terminal Tube Kit	RR/RD 5700/S
823238	Work Assist Tube Kit	SR 5200

Note: Plug for tubes is P.N. 124530

⚠WARNING: Cancer and reproductive harm - www.P65Warnings.ca.gov

143840-XXX

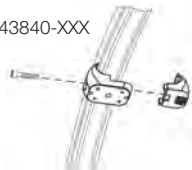

Clamp

Part Number

130145	Clamp
143840-001	Used on C5 Pneumatic, 45° angle
143840-002	Used on C5 Pneumatic, in line w/truck mtg
153181S	Clamp Kit; Used on FC4500
330146	CG CD Clamp Kit; Used on CG / CD front OHG



130145

Work Assist® Interface with RAM Mounting System



The Crown Ball Mount design (P.N. 351094-XXX) allows you to add the RAM mounting system to the Crown Work Assist® clamps and accessories. The addition of the RAM mounting system allows you to position your accessories for the best access and prevent damage due to shock and vibration. See RAM mount pages 6.09-6.12.

WORK ASSIST®

Terminal Mounting Plates



Part No.	Description	Model
126236-001	Mounting Bracket LXE	RR/RD 5000/S Series
126236-002	Mounting Bracket Norand	RR/RD 5000/S Series
126236-003	Mounting Bracket Telxon	RR/RD 5000/S Series
129572	Adjustable Bar & Mounting Bracket	RR/RD 5000/S Series
130146*	Mounting Plate	FC4000 Series, SC4000/5000 Series, SP3000/4000 Series, PE/PR4000 Series, RR/RD5000 Series, C5, TSP6000 /7000 Series

Part No.	Description	Model
131417*	Universal Mounting Plate	C5 Cushion, FC 4000 Series, SC 4000 Series, RC 3000/RC 5500, RM/RMD 6000/S, SP 3000 Series, PE/PR 4000 Series, RR/RD 5000/S Series/ TSP 6000/7000 Series
131418*	Mounting Bracket	C5 Cushion, FC 4000 Series, SC 4000 Series, RC 3000/RC 5500, RM/RMD 6000/S, SP 3000 Series, PE/PR 4000 Series, RR/RD 5000/S Series, TSP 6000/7000 Series
148748*	Universal Terminal Mounting Kit	C5 Cushion, FC 4000 Series, SC 4000 Series, RC 3000/RC 5500, RM/RMD 6000/S, SP 3000 Series, PE/PR 4000 Series, RR/RD 5000/S Series/ TSP 6000/7000 Series
814715	Bracket Data Log	ESR 4500/5000

*Works with Crown RAM; includes clamps; hardware needed

Note: Optional recommended ball mount size: 2.25" - P.N. 160809

Clip Pads



Clip Pad

Part Number

131415	Includes clamp
141462	Used on SH/SHR 5500
151743	Used on WP 3000

Note: Optional recommended ball mount size: 2.25" - P.N. 160809



Clip Pad and Hook

Part Number

130144	Includes clamp
141460	No clamp; includes plate to use on SH/SHR 5500

Note: Optional recommended ball mount size: 2.25" - P.N. 160809



Part Number

816658	Housing
814594	Spring
060062-003	Screw (qty. 2)

Used on RC 5500

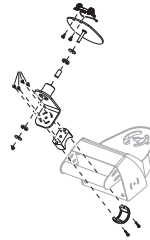

Clip Pad, Clamp-On

Part Number

146238

Used on PC 4500, E-Steer.

Note: Optional recommended ball mount size: 2.25" - P.N. 160809

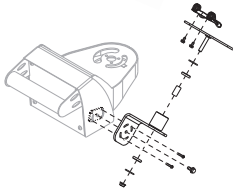

Clip Pad, Bolt-On

Part Number

146237

Used on PC 4500, E-Steer.

Storage

Continued ▶

Storage Organizer Kit Components



162915



162913



162912



154662



162914



162920

Part Number	Description	Size (Length x Width x Height)
162915	Bin	14.1" x 5.7" x 5.8"
162913	Small Pocket	4.3" x 2.1" x 5.5"
162912	Large Pocket	4.3" x 4.2" x 5.5"
162914	Bin Divider	13.3" x 4.2" X 1"
162920	Bin Weldment	13.6" X 4.8" X 3.2"
154662	Magnets	



163561-001

Organizer Kits with Bracket

Part Number	Description	Kit Components		
		Bin Divider (162914)	Small Pocket (162913)	Large Pocket (162912)
163561-003	Mixed Pocket Organizer		2	2
163561-001	Large Pocket Organizer			3
163561-002	Small Pocket Organizer		6	
163561-004	ClipBoard Organizer	1	3	

Includes: Bin (162915), Work Assist Clamp (130145), Bin Bracket (162920), and Hardware.



163506-002

Organizer Kits with Magnets

Part Number	Kit Description	Kit Components		
		Bin Divider (162914)	Small Pocket (162913)	Large Pocket (162912)
163506-002	Three Pocket Organizer			3
163506-003	ClipBoard Organizer	1	3	
163506-004	One Pocket Organizer			1
163506-001	Organizer	1		

Includes: Bin (162915), Magnets (154662) and Hardware.

Storage

Single Pocket Organizer Kits



163490-003

		Kit Components						
Part Number	Kit Description	Small Pocket (162913)	Large Pocket (162912)	Work Assist Clamp (130145)	Peanut Clamp (143840-001)	Pocket Mount (141752)	Small Pocket Bracket (163489)	Large Pocket Bracket (163488)
163490-004	Small Pocket Clamp	•		•		•	•	
163490-003	Large Pocket Clamp		•	•		•		•
163490-001*	Large Pocket P-Nut		•		•	•		•
163490-002*	Small Pocket P-Nut	•			•	•	•	

* Used on SC6000 Truck Models. Includes: Hardware.

Pocket

Part Number

130868	Orange; includes clamp
125997-001	Orange; used on Wave; 1 pocket kit
125997-002	Orange; used on Wave; 2 pocket kit
141461	Orange; used on SH/SHR 5500 kit
151744	Orange; used on WP 3000
141751	Orange pocket only

Pocket size: 5.14" x 2.25" x 7.5"

Note: Optional recommended ball mount size: 1" - P.N. 351094-001

Storage Net

Part Number

147004	Used on FC 4500, SC 6000, SC 5200
--------	-----------------------------------

Requires four 153181S clamps to mount

Storage Tray

Part Number



129988

129988	Used on trucks with Flex Seat - FC 4000 series, SC 4000 series
129988-002	Used on trucks with Suspension Seat - FC 4500, SC 4500, SC 5200
132715 ⚠	Replacement Magnet
060063-129	Replacement Screw
124973	Used on SC4000, SC6000, C-5 Pneumatic, C-5 Cushion, C-5 Diesel Pneumatic
147082	Replacement Storage Support Weldment for C-5

⚠WARNING: Cancer and reproductive harm - www.P65Warnings.ca.gov

Storage Tray Upper & Lower Kits

Part Number



141229S

141228S	Upper Storage Tray 21.2" x 3.5" x 4.25"
141229S	Lower Storage Tray 21.2" x 4.5" x 9.5"
141220	Upper Storage Tray - Tray Only. Used on PC 4500, TR 4500

Storage Module - Battery Cover Mount

Part Number

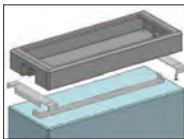

115870	Tray only 30.75" x 12.5" x 4"
117420	Used on trucks with no load backrest; includes one long bracket; designed to be removable
141042	Used on trucks with no load backrest; includes two side brackets; designed to be fixed

Storage Bin Kit

Part Number



157732	Includes 2 bins, 2 brackets, 2 double-sided tape squares, 2 bungees.
--------	--

Used on PTH50.
Replacement bin: P.N. 146693

Storage Bin Kit

Part Number



154661	Used on FC 5200
--------	-----------------

Includes bin and hardware.
Bin size: 28.43" x 8.3" x 5.35"

Storage Module - Battery Cover Mount

Part Number

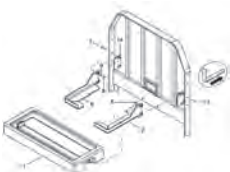

137513	Mounts to bolt-on load backrest
137514	Mounts to hinged load backrest

Storage Bin

Part Number



163424	Used on C-5 Penumatic, C-5 Cushion
--------	------------------------------------

Bin size: 22.61" x 7.72" x 6.92"

Storage Net Behind Seat

Part Number

147005S	
---------	--

Also order:
- 4 inserts 060103-006
- 4 screws 060062-041
- 4 wall hooks 147008



Storage Module, Magnetic Mount

Part Number



144441S	Includes tray, magnet and hardware. Can put two together and put on pallet truck battery cover. Used on PC 4500, TR 4500.
144442	Replacement Magnet
060062-059	Replacement Screw

Shrink Wrap Accessories



Shrink Wrap Tray

Part Number

131379

Used on PE 4000 Series, PW 3500, PR 4500



RC5500 Shrink Wrap Holder Kit

Part Number

H53382-501

Used with Shrink Wrap Stick, 300150



Shrink Wrap Holder Kit - Mounts on Pole

Part Number

145080

Model

PC 4500

147205S

SC 5200

Replacement holder: P.N. 144427

Note: Optional recommended ball mount size: 2.25" - P.N. 160809

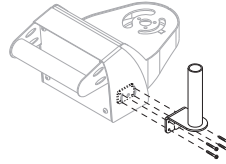

Shrink Wrap Holder Kit, Bolt-On

Part Number

145081

Replacement holder: P.N. 144427



Shrink Wrap Stick

Part Number

300150

Strong construction built to last in the most demanding applications. Quick change of stretch rolls with quarter-turn bottom loading mechanism. Automatic Tensioning System allows user to determine tension preference. Allows users to stand and walk forward while wrapping a pallet.

See shrink wrap on page 1.24



Shrink Wrap Holder

Part Number

158450

Model

Used on PE 4000/AC, PR 4500. Mounts to load backrest.

Note: Requires 2 screws 060017-108 and 2 nuts 060021-011 to mount.

Holders & Hooks



Cup Holder, Clamp-On

Part Number

145078

Used on PC 4500 E-Steer, FC 4000 Series, SC 4000 & 5000 Series, C5

Replacement cup holder: P.N. 144444

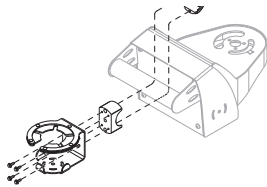

Note: Optional recommended ball mount size: 1.5" - P.N. 157749



Hook

Part Number

131419

For use with RF, includes clamp

141463

Does not include clamp, includes plate used on SH/SHR 5500

Note: Optional recommended ball mount size: 1.5" - P.N. 157749

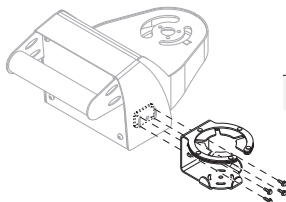

Cup Holder, Bolt-On

Part Number

145079

Used on PC 4500, E-Steer.

Replacement cup holder: P.N. 144444



Utility Hook

Part Number

131036

Note: Includes two hooks and warning labels.

Fire Extinguishers

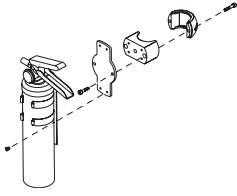

Fire Extinguisher Kit

Part Number

141187

Includes fire extinguisher. Used on SC 4000/5000 Series, FC 4000 Series, C5 & RC 5500

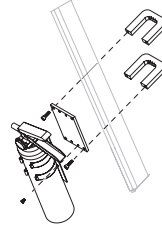

Fire Extinguisher Kit - Drive Thru Rack

Part Number

127591

Includes fire extinguisher. Used on FC 4000 Series & SC 4000/5000 Series

Note: U-clamps only, 127419

Fans



131388 (PE 4000)



140083 (RC 5500)

Fan Kits

Part Number	Type	Model
131388*	24V	PE 4000
140125*	24V	PE 4500, PR 4500
132781-002	24V	ST/SX 3000 (Mounted on work platform)
141459	24V	SH/SHR 5500
127503-001	36V	FC 4000 Series, SC 4000 Series
140083	36V	RC 5500
150226	36V	RM/RD 6000/S
127592-001	36V, Fits Drive Thru Overhead Guard	FC 4000, SC 4000 Series
127592-002	48V, Fits Drive Thru Overhead Guard	FC 4000 Series
127503-002	48V	FC 4000 Series
151351	12V	C-5 Pneumatic, C-5 Cushion

*Harness sold separately. Order Work Assist Electrical Kit, P.N. 140132.

Note: Optional recommended ball mount size: 1.5" - P.N. 157749

⚠ **WARNING:** Cancer and reproductive harm - www.P65Warnings.ca.gov

Fan Only

Part Number	Type	Model
127259-010	12V with switch	C5
127259-007	24V with switch	PE 4000 Series, ST/SX 3000, RR 5200
125755	24V with switch	RC 3000
127259-004	24V without switch	PE 4000 Series
127259-002	36V with switch	SC 4000 Series, FC 4000 Series, RR 5200
127259-005	36V without switch	FC 4000 Series, SC 4000 Series, RC 5500
127259-003	48V with switch	FC 4000, TSP 6000
127259-006	48V without switch	FC 4000 Series, TSP 6000

Fan & Worklight Kit

140127	24V without switch	PE 4500AC, PR 4500
--------	--------------------	--------------------

Lights



Strobe Light Kit

Part Number Color

131377-001	Amber
131377-002	Red
131377-003	Blue



Flashing Light Kit

Part Number

131378



131376 (PE 4000)

Front Worklight Kits

Part Number	Description	Model
128921	Drive Thru Overhead Guard	FC 4000 Series
129589	Standard Overhead Guard Mounted	FC 4000 Series
127528-001	Drive Thru Overhead Guard	SC 4000
127532-001	Standard Overhead Guard Mounted	SC 4000 Series
*131376	Mounted on Work Assist Pole	PE 4000 Series
140126	Mounted on Work Assist Pole	PR 4500 & PE 4500
133896-002	Mounted on Work Assist Pole	ST/SX 3000

*Does not include mounting brackets



Dome Light

Part Number

123683

Used on RM/RMD 6000/S, RC 5500. Will also need to order plate 139555, 2 of 060030-010, 2 of 060059-034, 2 of 060061-038, 2 of 060062-027 and clamp 130145.

Platforms



Work Platform

Part Number

133892S

Accessories:
Work Platform Tray
(P.N. 133894)
Used on ST/SX 3000



Snap-On Platform

Part Number W x L (in)

131069-001 25 x 36.50

131069-002 25 x 42.50

131069-003 25 x 48.50

Used on ST/SX 3000



Remote

Part

Number	Mast Type	Application
132782-002	ST/SX 3000, TL	Ground
132782-003	ST/SX 3000, TT	Ground
133895-002	ST 3000, TL Mast	Platform
133895-003	ST 3000, Sideshift, TL Mast	Platform
133895-004	SX 3000, TL Mast	Platform
133895-005	ST 3000, TT Mast	Platform
133895-006	ST 3000, Sideshift, TT Mast	Platform
133895-007	SX 3000, TT Mast	Platform

Miscellaneous



Programmable Security Lock

This keypad offers an enhanced level of security to deter unauthorized or untrained personnel from operating the vehicle. A four digit Personal Identification Number can be assigned for up to 200 operators that use the vehicle. Supervisor can "lockout" vehicle through keypad and can program keypad to turn vehicle "OFF" automatically if vehicle is idle for prolonged periods.

Power input is 15 amps externally fused, 48 volts maximum. Power output is 10 amps maximum. Operating temperature range is -40 to +85° Celsius.

Part Number	Used On	Kit Instructions
130863-001	Wave	
130863-002	RC3, FC4, Turret, SP48, SP3000	
130863-003	WP2300	PF26004
130863-003	WP3000	PF26265

Kit Instructions for Programming

PF11830	Dealer Level
PF11831	Manager Level
PF11832	Supervisor Level



Bracket Assembly for Mirror, Rear View

Part Number

134212

Note: Used on TSP 6000/7000, SP 4000

Order Separately
- Clamp 130145
- Screw 060061-022 (Qty.4)
- Mirror 137670



Tool Retractor

Part Number

300114

Capacity 1.76-4.4 lbs. (0.8-2.0kg)
Extended rope length - 5.5 ft.



Pick Assist Tool

Part

Number Description

351101	Pick Assist Tool
351100	Mounting Kit for SP

The pick assist tool has a lightweight, telescoping design that will effortlessly extend the reach of the order picking staff. It has a collapsed length of 28" and can be extended to 40". This versatility allows the stick to be set into place at any length desired by the order picker to ensure maximum effectiveness. Features hole in plate to pull boxes by the corner.

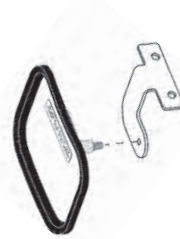

Mirror Kit

Part

Number	Series	Description
130673	C5, FC4000/4500 & SC4000/45000	Glass
150511S001	SC5200, standard overhead guard	Glass
150511S002	SC5200, standard overhead guard	Plastic

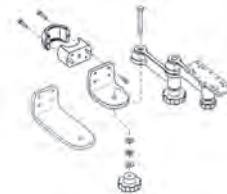

Adjustable Arm System Kit

Part Number

136994

Note: Used on TSP 6000/7000 & SR Replacement Arm Mount:
P.N. 136993

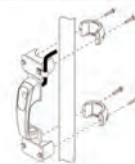

Handle with Horn Switch Kit

Part Number

148152

Used on FC 4500 and SC 4500.

RAM Mounts

Protect your electronic devices by using the RAM Mounting System. RAM mounts utilize a patented rubber ball and socket design which isolates and dampens shock and vibration up to 50G of shock. Adjustable positioning features can not be matched by another mounting method. Mounting bases quickly attach and fit every OEM lift cage or overhead guard made. All backed by a lifetime manufacturer's warranty. Made in USA.

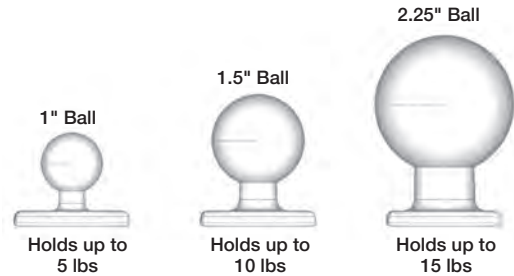

How to Order:

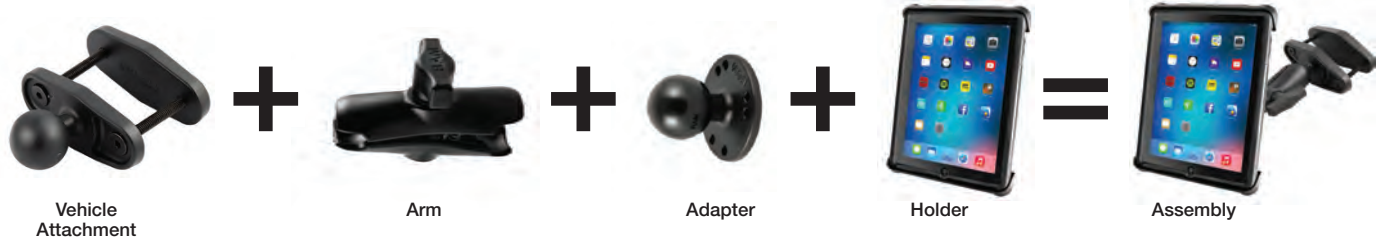

Work Assist® Interface with RAM Mounting System



The Crown Ball Mount design (P.N. 351094-XXX) allows you to add the RAM mounting system to the Crown Work Assist® clamps and accessories. The addition of the RAM mounting system allows you to position your accessories for the best access and prevent damage due to shock and vibration. See RAM mount pages 6.09-6.12.

Vehicle Attachments

Continued ▶



Crown Work Assist® Ball Base

Rubber ball connected to oval base with mounting holes aligned to work with Crown Work Assist® Accessories. See pages 6.02-6.08.

Part No.	Description
351094-001	1" ball with 2.52" x 1.85" oval base
157749	1.5" ball with 2.52" x 1.85" oval base
160809	2.25" ball with 2.52" x 1.85" oval base



2.5" Diameter Magnetic Base

Has pre-drilled holes, including the AMPS hole pattern. The magnetic base contains 3 rare earth magnets that hold firm to ferrous metals. The adapter designed to conceal the magnets is made of a durable plastic composite to prevent scratching the mounting surface.

Part No.	Description
351095-011	1" ball



Round Base with Rubber Ball

Consists of a rubber ball connected to a flat round base. This mount has pre-drilled holes, including the universal AMPS hole pattern.

Part No.	Description
351095-006	1" ball with 2 ⁷ / ₁₆ " diameter base
157750	1.5" ball with 2 ¹ / ₂ " diameter base
351095-008	2.25" ball with 3 ¹ / ₁₆ " diameter base
351095-009	2.25" ball with 3 ¹ / ₁₆ " diameter base, reinforced steel



V Base Ball and Straps

Fits circular and square rails from 1" to a max of 2.1" diameter. To mount, place the saddle shaped plate on the rail then wrap the metal clamp strap around the rail and plate. Tighten the screw knob on the metal strap with a screw driver until the strap has a firm hold on the rail.

Part No.	Description
351095-021	1" ball
351095-022	1.5" ball



3.25" Diameter Suction Cup

Suction cup designed to have an extra hold on any smooth, non-porous surface. For best results mount the suction cup on glass or non-porous plastic surface.

Part No.	Description
351095-010	1" ball



Diamond Drill Down Base with Rubber Ball

Consists of a 1" diameter rubber ball connected at right angles to a 2.43" x 1.31" diamond base. The base has 2 holes 1.912" from center to center, matches the industry standard AMP's hole pattern and will connect to a large variety of RAM mounts and third party cradles.

Part No.	Description
351095-018	1" ball

Vehicle Attachments



Rubber Ball with Clamp Base - 4"

Fits on square rails up to 4" wide and 2 1/8" deep. Can fit much smaller rails if needed by angling.

Part No.	Description
351095-001	1" ball
160249-001	1.5" ball
160249-002	2.25" ball



Rubber Ball with Clamp Base - 2.5"

Fits on square rails up to 2.5" wide.

Part No.	Description
351095-004	1.5" ball
351095-005	2.25" ball



Measure upright support as shown in image. Select clamp base which most closely matches the widest dimension.



Overhead Guard Mount

The Overhead Guard Mount attaches to most any lift cage or overhead guard. Utilizing two identical plates of stamped steel with numerous common hole patterns and slots. 1.5" & 2.25" diameter bases may be attached to the same plate for multiple applications.

Part No.
351095-019

Requires a square base: 1.5" ball (P.N. 351095-012) or 2.25" ball (P.N. 351095-013 or P.N. 351095-014).



Arms



Double Ball Socket Arm, Short

The short double socket arm, has a socket at both ends that fits ball bases. RAM socket technology allows for almost infinite adjustment and perfect viewing angles.

Part No.	Works With	Overall Length
351095-027	1" ball	2.38"
351095-028	1.5" ball	3.5"
160808-002	2.25" ball	5.0625"



Double Ball Socket Arm, Long

Has a socket at both ends that fits ball bases. A single spring inside the arm opens the end sockets, allowing you to pivot the ball and socket connection. This socket technology allows for almost infinite adjustment and perfect viewing angles.

Part No.	Works With	Overall Length
351095-030	1" ball	6"
351095-031	1.5" ball	9.125"
160808-003	2.25" ball	12.875"



Double Ball Socket Arm, Standard

Has socket at both ends that fits ball bases. A single spring inside the arm opens the end sockets, allowing you to pivot the ball and socket connection. Allows for almost infinite adjustment and perfect viewing angles.

Part No.	Works With	Overall Length
351095-024	1" ball	3.69"
351095-025	1.5" ball	5.625"
160808-001	2.25" ball	8.375"



Adjustable Socket with Octagon Socket

Consists of double 1" diameter open ball sockets with a 360° rotation point at the center & a connecting swivel joint that rotates forward and back 180°. The rubber ball and socket at either end, and a central pivot point provides unsurpassed adjustability. The RAM ball sockets maximize ball coverage for optimal fit.

Part No.	Works With	Overall Length
351095-033	1" ball	6.25"

Mount Assembly



Universal Mount with 2 Round Bases

Consists of one double socket arm and two round bases that contain the universal AMPS hole pattern. The hole pattern found on the round base adapter will connect to many RAM cradles, including all iPad cradles.

Part No.	Ball Base	Double Socket Arm	Overall Height	Ball Size
144357	351095-006	351095-027	5"	1"
150311	157750	351095-025	7.40"	1.5"



RAM Mount Base

The RAM mount base assembly consists of a double socket arm and two ball bases. 157749 is designed to integrate with the Crown Work Assist clamp and the second base contains the universal AMPS hole pattern.

Part No.	Ball Base	Double Socket Arm	Ball Base	Overall Height	Ball Size
157748-001	157749	351095-025	157750	7.42"	1.5
157748-002	157749	351095-028	157750	5.29"	1.5
157748-003	157749	351095-031	157750	10.92"	1.5

Adapters

Round Base with Rubber Ball

Consists of a rubber ball connected to a flat round base. This mount has pre-drilled holes, including the universal AMPS hole pattern.



Part No.	Description
351095-006	1" ball with 2 ¹ / ₁₆ " diameter base
157750	1.5" ball with 2 ¹ / ₂ " diameter base
351095-008	2.25" ball with 3 ¹ / ₁₆ " diameter base
351095-009	2.25" ball with 3 ¹ / ₁₆ " diameter base, reinforced steel

Square Base with Rubber Ball

Rubber ball, connected to a 3.625" square plate with a 75x75mm VESA hole pattern. The rubber ball is positioned 0.88" from the center of one edge.



Part No.	Description
351095-015	1.5" ball
351095-016	2.25" ball

Square Base with Rubber Ball

Rubber ball, connected to a 4.75" square plate with 4x100mm holes and 4x75mm holes in each corner.



Part No.	Description
351095-012	1.5" ball
351095-013	2.25" ball
351095-014	2.25" ball (reinforced steel)

Diamond Drill Down Base with Rubber Ball

Consists of a 1" diameter rubber ball connected at right angles to a 2.43" x 1.31" diamond base. The base has 2 holes 1.912" from center to center, matches the industry standard AMP's hole pattern and will connect to a large variety of RAM mount and third party cradles.



Part No.	Description
351095-018	1" ball

HOLDERS

Continued ▶

X-Grip® Universal Holder

Has a clean and clever four leg design that sports great holding power without hiding your phone behind foam pads and plastic. Dimensions: width - 1.875" - 3.25", depth 0.875".



No ball base adapter required.

Part No.	Description
351095-034	1" ball

X-Grip® Universal for 5" Phablets

Has a clean and clever four leg design that sports great holding power without hiding your phone or phablet behind foam pads and plastic. Compatible and interchangeable with a wide range of mounts. Dimensions: width 1.75"-4.5".



No ball base adapter required.

Part No.	Description
351095-035	1" ball

Tough-Claw™ with X-Grip® Holder

Tough-Claw™ base and universal X-Grip® holder. The X-Grip® holder has a clean and clever four-leg design that sports great holding power without hiding your smartphone behind foam pads and plastic.



Part No.
351095-052

Universal Finger-Grip™ Phone/Radio Holder

Designed to hold a large amount of cell phones & electronic devices — comes with 3 sets of 4 flexible rubber coated fingers placed along sides to grip your device. Fingers open by squeezing ends to open small finger arms. Bottom of the holder includes back plate that adds support to the device being held by the mount. Spine plate contains universal AMPs and 1.5" x 2" hole patterns. Min/Max with top & bottom plates: Height 5.25" to 6". Plates can be removed for larger devices.



Part No.
351095-036

Requires ball base adapter 157750.

Power-Grip™ Universal Scanner Gun Cradle

Compatible with a wide range of ruggedized 2D barcode scanners. Accommodates pistol grip scanner guns with a maximum pistol grip of 1.4". Internal dimensions 3.47" x 2.16" x 4.9".



Part No.
351095-037

Requires ball base adapter 157750.



RAM-X-Grip® III Universal Clamping Cradle for 10" Tablets

Spring loaded holder for large tablets, with or without a case. Accommodates netbooks as well. Dimensions:



Part No.
351095-045

Tray Depth	Tray Thickness	Tray Width (Expansion)	Side Clamp Arm Height
6.0"	1.0"	8.56" - 11.12"	2.75" max

Requires ball base adapter 157750.

Universal Holder for Scanner Guns and Handheld Computers

Specially designed cradle that will hold most types of gun scanner handles. On the side of the cradle is a spring loaded lever that will securely hold the gun scanner in the cradle. Designed for pistol grip scanners.



Part No.
351095-039

Requires ball base adapter 157750.

Tab-Tite™ Kit for Large Tablets

Fits most 10" tablets. Includes 2 sets of interchangeable cups to give the user a custom fit. Spring loaded. Cradle dimensions:



Part No.
351095-042

Height	Max. Width	Max. Edge Depth
8.50" - 10.75"	7.75"	0.56"
8.75" - 10.75"	8.25"	1.10"

Requires ball base adapter 157750.

Holders



Tab-Lock™ Kit for Large Tablets

Same as 351095-042 except locks for theft deterrent. Cradle dimensions:

Height	Max. Width	Max. Edge Depth
8.00" - 10.25"	6.80"	0.50"
8.25" - 10.25"	7.75"	0.56"

Requires ball base adapter 157750.

Part No.
 351095-043



Tab-Tite™ Kit for Small Tablets

Fits most 7-8" tablets. Includes 3 sets of interchangeable cups to give the user a custom fit. Spring loaded retention to hold device securely on the forklift. It is compatible with the following tablets with or without skins, sleeves or cases: Archos 7, Asus EEE Pad Memo, Asus Tough-ETBW11AA, Barnes & Nobel NOOKcolor, BlackBerry Playbook, Dell Streak 7, HTC Flyer, Google Nexus 7, Samsung Galaxy. Cradle is compatible with any tablet that will fit the dimensions listed below. It is important to verify the dimensions of your tablet with a case/sleeve/skin when determining the overall size. Cradle dimensions:

Height	Max. Width	Max. Edge Depth
6.80" - 9.000"	5.31"	0.125" - 0.56"
7.00" - 9.100"	4.70"	0.125" - 0.44"
7.30" - 9.620"	5.31"	1.06"

Requires ball base adapter 157750.

Features:

1. Support cups contain open slots to fit tablets of various sizes
2. Back plate can support various size support cups
3. Spring loaded tension provides secure support for your tablet
4. Spring loaded cradle allows for quick release of your tablet
5. Full access to all ports



Tab-Lock™ Kit for Small Tablets

Same as 351095-040 except locks for theft deterrent. Cradle dimensions:

Height	Max. Width	Max. Edge Depth
6.55" - 9.80"	5.31"	0.125" - 0.56"
6.75" - 9.90"	4.70"	0.125" - 0.44"
7.05" - 10.42"	5.31"	1.06"

Requires ball base adapter 157750.

Part No.
 351095-041

Universal Portable Printer Cradle

Uses unique patent pending spring-loaded mechanism that holds strong, yet provides easy removal for printer storage. At each end of cradles are side clamping plates designed to fit cleanly around edges of a printer.

Part No.	Clamping Dimensions	Max. Height
351095-054	6.625" - 10.5"	2.5"
351095-055	5.625" - 9.5"	1.75"



Universal X-Grip® II Tablet Holder with 1.5" Ball for Small Tablets

Four leg design has great holding power and does not hide your tablet behind foam pads or plastic. Spring loaded holder and 1.5" rubber ball connect to the back of the base. Includes extra easy access grip knobs located on the back of the holder for quick release of your tablet. This holder expands and contracts for perfect fit of most 7" tablets.

Part No.
 351095-046

Min. Width	Max. Width	Depth
2.25"	5.75"	0.875"

Note: Devices 2.25" in width must be a minimum of 7" in height to fit.

No ball base adapter required.

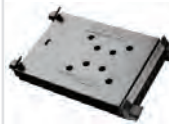

Universal Laptop Mount Tough Tray II™

Spring loaded holder for large tablets, with or without a case. Accommodates netbooks as well. Dimensions:

Part No.	Tray Depth	Tray Thickness	Tray Width (Expansion)	Side Clamp Arm Height
351095-044	6.0"	1.0"	8.56" - 11.12"	2.75" max

Requires ball base adapter 157750.



Universal Laptop Tough Tray™ Holder with Flat Retaining Arm

Spring loaded expandable tray that accommodates 10 to 16 inch wide laptops. Includes four flat side clamping arms that allow your laptop to close completely while in the tray. These arms can be moved both vertically and horizontally allowing for a custom fit for varying thicknesses of laptops and the freedom of not blocking ports or drives. Hole patterns on perimeter of tray facilitate the mounting of additional RAM systems to support GPS, PDAs or other electronics.

Part No.
 351095-051

Tray Depth	Tray Thickness	Side Clamp Arm Height
10.0"	2.125"	0.5" to 1.75"



Keyboard Mount

This simple design clamps an 8" tube between any RAM tablet cradle, and the Patent Pending Roto-View™ round adapter plate allows for adjustment to accommodate many tablet configurations, including use in both landscape and portrait mode. The 8" tube has a 1" ball on the end which connects to a standard RAM double socket arm and Magnetic Power Plate III for easy placement and removal of the keyboard.

Part No.
 351095-057



Locking Knob - Locks the Arms

Includes a brass thread for 1" or 1.5" socket arms, thus allowing you to disengage the screwing of the knob. Once you have set your mount in the location you need, you can lock it in place and feel safe that your mounted device will stay right where you left it.

Part No.	Thread Size	Works With
351095-047	¼" - 20 thread	1" ball arm
351095-048	⅝" - 18 thread	1.5" ball arm

Camera Systems

Design a camera system with three easy pieces: camera, cable and monitor. The system you select can be easily installed and is plug-and-play.

Cameras can provide a fork view, front view, rear view, or mid mast view. Please contact your local dealer for assistance in choosing the right parts to complete your system.

How to Order:



Cameras

Camera FAMOS

- Next generation CMOS sensor
- High light sensitivity: 0.05 lux
- High resolution: 640*480
- Integrated safety ticker
- Openings angles from 16°-129°
- Camera has a 1.6 ft. cable including a waterproof 4 pin male connector



	NTSC	PAL
Camera 129°	340095-143	340095-156
Camera 118°	340095-144	340095-157
Camera 102°	340095-145	340095-158
Camera 118°-Mirror	340095-146	340095-159
Camera 69°	340095-147	340095-160
Camera 58°	340095-148	340095-161
Camera 24°	340095-149	340095-162
Camera 16°	340095-150	340095-163

Camera FAMOS

- Camera has a 0.8 ft. cable including a 6 pin male Deutsch connector



	NTSC	PAL
Camera 80°	147125-001	147125-002

Camera FAMOS IR LED

- Day/Night camera including 15 high power infrared LEDs 850nm
- Camera has a 1.6 ft. cable including a waterproof 4 pin male connector



	NTSC	PAL
Camera 69° IR LED	340095-151	340095-164
Camera 118° IR LED	340095-152	340095-165

Cameras

- NTSC (60Hz) used in North America
- PAL (50Hz) Check Global Guidelines
- Operating temperature -40F to +185F
- Lens is chemically hardened and has an anti-dust and condensation coating
- Impact and vibration proof
- 2-year warranty

Camera AMOS CPH

- Extremely robust small camera for mounting on a vulnerable position
- Color camera
- Fixed lens angle at 51°
- Camera has a 1.6 ft. cable including a waterproof 4 pin male connector



	NTSC	PAL
Camera (600 mm cable/approx. 2')	340095-166	340095-153
Camera (200 mm cable/approx. 0.6')	340095-168	340095-167

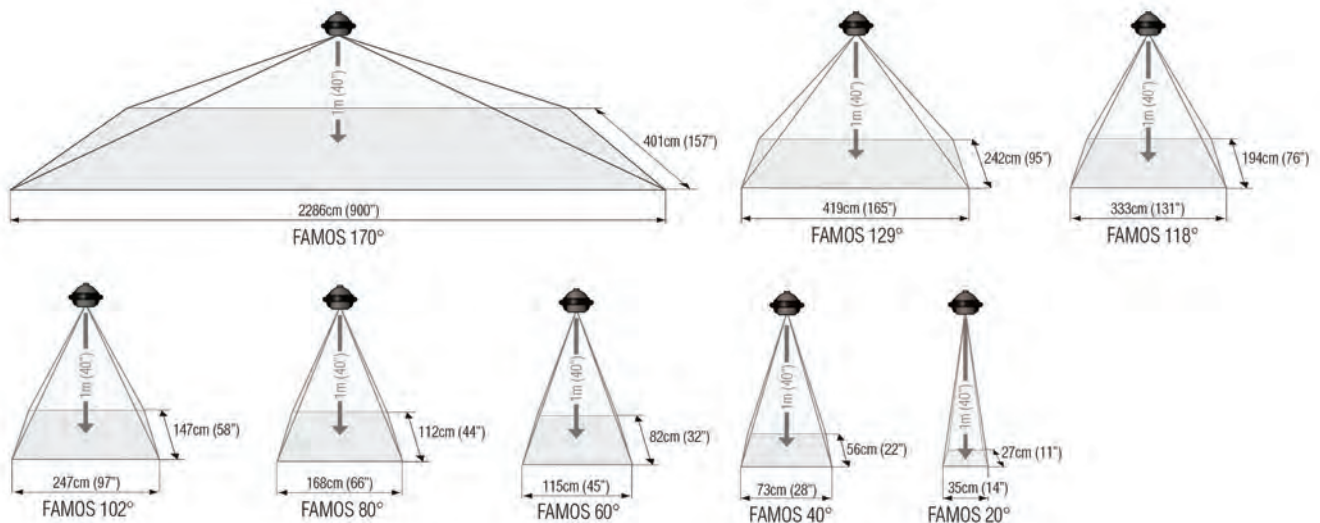

The measurements given above are theoretical. Practical situations may deviate.

Monitors

Monitors

- Liquid Crystal Display module, LED backlight
- Impact and vibration resistance
- Power protected against induction voltages, load dumps, over and under voltage
- High resolution pixel WVGA 800X480
- Full on screen display in 12 languages
- Water tight molded connectors
- 2-year warranty



Monitor 7" RLED R 4 CS (12-60V)

- Part No.** 340095-014
- 13.1ft. multicable open wired w/4p female connector
 - 5.2 inch mounting bracket
 - Suitable for open cold store applications

Monitor 7" RLED RC 4 CS (12-60V)

- Part No.** 340095-015
- 13.1 ft. multicable open wired w/4p female connector
 - 7.5 inch adjustable mounting bracket with clamp
 - Suitable for open cold store applications

Monitor 7" RLED Serial R 6 (18-30V)

- Part No.** 340095-016
- 19.7 ft. multicable open wired w/7p female connector
 - 5.2 inch mounting bracket
 - Used with P.N. 340095-155

Monitor 7" RLED CAN SRD 6 (12-60V)

- Part No.** 340095-017
- 19.7 ft. multicable open wired w/7p female connector
 - 5.2 inch mounting bracket
 - Specifically designed for RadarEye systems

Monitor 12" RLED R 4 (12-30V)

- Part No.** 340095-018
- 13.1ft. multicable open wired w/4p female connector
 - 7.5 inch mounting bracket

Monitor 12" RLED Serial R 6 (12-30V)

- Part No.** 340095-019
- 19.7 ft. multicable open wired w/7p female connector
 - 7.5 inch mounting bracket
 - To be used in combination with 340095-155

Monitor 12" RLED CAN SRD 6 (12-30V)

- Part No.** 340095-020
- 19.7 ft. multicable open wired w/7p female connector
 - 7.5 inch adjustable mounting bracket with clamp
 - Specifically designed for RadarEye systems

Cables

Dynamic Cable (Mast Cable) 4 Pin

Part Number	Length
340095-021	1.6 ft.
340095-022	3.3 ft.
340095-023	10.4 ft.
340095-024	11.5 ft.
340095-025	16.4 ft.
340095-026	19.7 ft.
340095-027	26.2 ft.
340095-028	29.5 ft.
340095-029	32.8 ft.
340095-030	36.1 ft.
340095-031	39.4 ft.
340095-032	44.9 ft.
340095-033	45.9 ft.

Three-Stage Mast Example

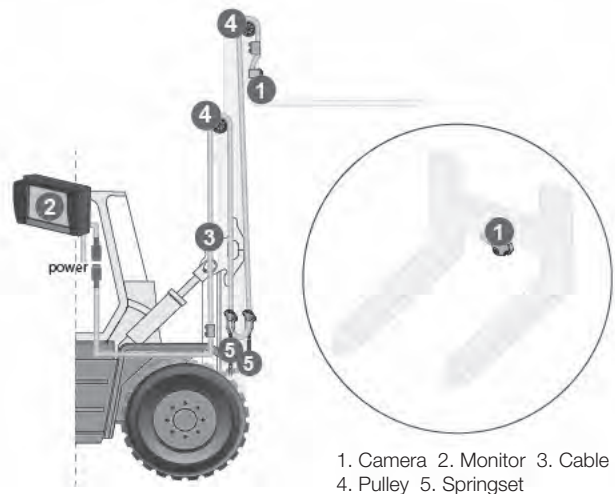

Options

Pulley

Part No.
340095-086



- 3.1 inch diameter
- Stainless steel brackets and anodized aluminum pulley
- Suitable for -58° F to 302° F

Spring Set

Part No.
340095-087



For pre-tensioning mast cable

Switchers

Part No.
340095-089 Switcher UNI IP54
340095-090 Switcher UNI IP67



Inputs and power supply for three cameras and in combination with a Y-split cable: Four cameras.

- 4 pin output for monitor
- Cameras can be switched over automatically or manually

Camera Kits

Camera Kit for RM/RMD 6000

Part Number	Description
150992-001	42" NTSC
150992-002	48" NTSC
150992-003	42" PAL
150992-004	48" PAL

7 inch color LCD monitor with LED backlight (P.N. 149430). Camera 80°.

Replacement parts:

147922 Camera Module - Unprogrammed
 149116 Monitor Mount Kit
 148470 Camera Mount Cover
 148800 Camera Mount Weldment



Mast Camera Kit for RR/RD 5700/S

Part Number	Description
147287-001	42" NTSC
147287-002	48" NTSC
147287-003	42" PAL
147287-004	48" PAL

7 inch color LCD monitor with LED backlight (P.N. 149430). Camera 80°.

Mast camera cable sold separately - see P.N. 147145-xxx below.

Work assist tube and clamp not included; reference installation instructions.

Replacement monitor mounting bracket P.N. 146836
 Replacement cable for monitor P.N. 349430-001



Mast Camera Cable 6 Pin

Part Number	Truck Lift Height	
	mm	in
147145-007	6858	270
147145-008	7620	300
147145-009	8153	321
147145-010	8661	341
147145-011	9296	366
147145-012	10160	400
147145-013	10693	421
147145-014	11227	442

Fork Level Indicator



Part No.
340402

Accu-Tilt

Accu-Tilt is a Fork Tilt Level Indicator that shows the operator the level of the forks at all times, thereby reducing potential damage by piercing product or racking and increasing productivity by eliminating the guess work. Additionally, the Accu-Tilt's Fork Tilt Level Indicator will also indicate to the operator the correct fork angle to travel with a load as well as parking the lift truck.

* For use on Counterbalance trucks

Forklift Laser Guidance System

Continued ▶

The Forklift Laser Guidance System provides operators a continuous visual reference of fork position which aids in increasing safety, accuracy, and productivity, while reducing product damage.

The laser projects a line or dot onto the pallet or product indicating the level of the forks which allows operator heightened visibility and more accurate fork placement.

Laser Models:

- Basic Standard - Basic standard
- Cold Storage - Designed for low-temperature and high-moisture environments
- Height Control - Designed only to operate at 7' and above
- Remote Power - Comes with key fob power control

Laser Types:

- Line - Best for low-light areas such as warehouses
- Dot - Best for cold storage and outdoor usage

Features For Battery-Operated Laser Guidance:

- Contains two lithium ion batteries
- Charger included
- Shuts off after 4 mins without movement, saving battery life
- Automated vibration controlled start
- Heavy duty
- Self contained
- Quick battery change

Mounting:

- Single laser, dual laser, and hard wired series units mount directly to the forklift carriage in less than five minutes. Fork mount laser units attach to the fork directly.
- Laser guides fit class II carriages
- Class III or non standard carriages require fork mount



Batteries:

- 80+ continuous hours of life per battery
- Quick charge 3 hours; full charge in 8 hours
- Batteries are double shrink wrapped for durability
- Batteries are equipped with an Over-Current Protection System

Single Laser Series

Red Laser Part Number	Green Laser Part Number	Description	Laser Type
351093-001	351093-001-G	Basic Std	Line
351093-001-D	351093-001-D-G	Basic Std	Dot
351093-002	351093-002-G	Water Resistant	Line
351093-002-D	351093-002-D-G	Cold Storage - Water Resistant	Dot
351093-003	351093-003-G	Height Control	Line
351093-003-D	351093-003-D-G	Height Control	Dot
351093-019	351093-019-G	Height Control - Water Resistant	Line
351093-019-D	351093-019-D-G	Height Control - Cold Storage - Water Resistant	Dot

▲WARNING: Cancer and reproductive harm - www.P65Warnings.ca.gov



351093-003-D

Dual Laser Series

Red Laser Part Number	Green Laser Part Number	Description	Laser Type
351093-004	351093-004-G	Basic Std	Dot & Line
351093-005	351093-005-G	Cold Storage-Water Resistant	Dot & Dot
351093-006	351093-006-G	Height Control	Dot & Line
351093-016	351093-016-G	Basic Std - Hard Wired	Dot & Line
351093-017	351093-017-G	Cold Storage-Water Resistant	Dot & Dot
351093-018	351093-018-G	Height Control	Dot & Line
351093-020	351093-020-G	Height Control - Cold Storage - Water Resistant	Dot & Dot
351093-040	351093-040-G	Basic - Remote Power	Dot & Line
351093-041	351093-041-G	Cold Storage-Water Resistant-Remote Power	Dot & Dot

The dual laser feature is designed for repetitive moving of product. This feature incorporates two distinct lasers to aid the operator. The first laser directs the forks into the pallet and the second laser guides the pallet onto the rack.

▲WARNING: Cancer and reproductive harm - www.P65Warnings.ca.gov



351093-006

Fork Mount Laser Series

Red Laser Part Number	Green Laser Part Number	Description	Laser Type
351093-007	351093-007-G	Basic Std	Line
351093-007-D	351093-007-D-G	Basic Std	Dot
351093-008	351093-008-G	Water Resistant	Line
351093-008-D	351093-008-D-G	Cold Storage-Water Resistant	Dot
351093-009	351093-009-G	Height Control	Line
351093-009-D	351093-009-D-G	Height Control	Dot
351093-025	351093-025-G	Fork Mount - Water Resistant - 1 3/4"	Line
351093-036	351093-036-G	Height Control - Water Resistant	Line
351093-036-D	351093-036-D-G	Height Control - Cold Storage-Water Resistant	Dot
351093-037	351093-037-G	Basic - Remote Power	Line
351093-037-D	351093-037-D-G	Basic - Remote Power	Dot
351093-038	351093-038-G	Water Resistant-Remote Power	Line
351093-038-D	351093-038-D-G	Cold Storage-Water Resistant-Remote Power	Dot



Fork mount lasers are designed for the non-standard fork carriages. Lasers are mounted directly to the fork of the lift truck.

Note: All fork mount lasers are custom parts. 30-day lead time. Must have fork measurements at time of order.

WARNING: Cancer and reproductive harm - www.P65Warnings.ca.gov

Hard Wired Laser Series

Red Laser Part Number	Green Laser Part Number	Description	Laser Type
351093-012	351093-012-G	Basic Std	Line
164440-001	351093-042-G	Basic Std - Orange; Includes Cable & Deutsch Connector	Line
351093-012-D	351093-012-D-G	Basic Std	Dot
351093-013	351093-013-G	Water Resistant	Line
351093-013-D	351093-013-D-G	Cold Storage-Water Resistant	Dot
351093-014	351093-014-G	Height Control	Line
351093-014-D	351093-014-D-G	Height Control	Dot
351093-015	351093-015-G	Water Resistant - Height Control	Line
351093-015-D	351093-015-D-G	Cold Storage - Water Resistant - Height Control	Dot
351093-021	351093-021-G	Basic - Remote Power	Line
351093-021-D	351093-021-D-G	Basic - Remote Power	Dot
164440-002	351093-024-G	Water Resistant - Orange; Includes Cable & Deutsch Connector	Line



Includes cable or deutsch connector. Oil and water resistant wires are hard wired directly into truck battery with voltage systems between 12-55 DC. Matching pigtailed are provided for power connection. (Wiring for most not included.) Experienced personnel are recommended for self-installation.

WARNING: Cancer and reproductive harm - www.P65Warnings.ca.gov

Remote Powered Laser Series

Red Laser Part Number	Green Laser Part Number	Description	Laser Type
351093-030	351093-030-G	Water Resistant - Remote Power	Line
351093-030-D	351093-030-D-G	Cold Storage - Water Resistant - Remote Power	Dot
351093-031	351093-031-G	Dual - Remote Power	Dot & Line
351093-032	351093-032-G	Dual - Cold Storage - Water Resistant - Remote Power	Dot & Dot
351093-033	351093-033-G	Hard Wired - Water Resistant - Remote Power	Line
351093-033-D	351093-033-D-G	Hard Wired - Cold Storage - Water Resistant - Remote Power	Dot
351093-034	351093-034-G	Hard Wired - Dual - Remote Power	Dot & Line
351093-035	351093-035-G	Hard Wired - Dual - Cold Storage - Water Resistant - Remote Power	Dot & Dot

Remote Power – Comes with key fob power control.

WARNING: Cancer and reproductive harm - www.P65Warnings.ca.gov

Accessories

Part No.	Description
351093-022	Face Plate Assembly
351093-023	Power Plug Adapter (works in Australia, China & New Zealand)
351093-026	Replacement Pigtail
351093-027	Rechargeable Lithium Ion Battery
351093-028	Lithium Charger
351093-043	Polarity Changer

WARNING: Cancer and reproductive harm - www.P65Warnings.ca.gov

Forklift Laser Guidance System

Forklift Laser Guidance Systems

Power Source	Laser Output	Mounting Type	Laser Type	Red Laser Part No.	Green Laser Part No.	Description	Water Resistant Seal	Cold Storage	Height Control	Remote Power
Battery	Dot	Carriage	Single	351093-001-D	351093-001-D-G	Basic Std				
Battery	Dot	Carriage	Single	351093-002-D	351093-002-D-G	Cold Storage - Water Resistant	•	•		
Battery	Dot	Carriage	Single	351093-003-D	351093-003-D-G	Height Control			•	
Battery	Dot	Carriage	Single	351093-019-D	351093-019-D-G	Height Control - Cold Storage - Water Resistant	•	•	•	
Battery	Dot	Carriage	Single	351093-030-D	351093-030-D-G	Cold Storage - Water Resistant - Remote Power	•	•		•
Battery	Dot	Fork Mount	Single	351093-007-D	351093-007-D-G	Basic Std				
Battery	Dot	Fork Mount	Single	351093-008-D	351093-008-D-G	Cold Storage - Water Resistant	•	•		
Battery	Dot	Fork Mount	Single	351093-009-D	351093-009-D-G	Height Control			•	
Battery	Dot	Fork Mount	Single	351093-036-D	351093-036-D-G	Height Control - Cold Storage - Water Resistant	•	•	•	
Battery	Dot	Fork Mount	Single	351093-037-D	351093-037-D-G	Basic - Remote Power				•
Battery	Dot	Fork Mount	Single	351093-038-D	351093-038-D-G	Cold Storage - Water Resistant - Remote Power	•	•		•
Battery	Dot & Dot	Carriage	Dual	351093-005	351093-005-G	Cold Storage - Water Resistant	•	•		
Battery	Dot & Dot	Carriage	Dual	351093-020	351093-020-G	Cold Storage - Water Resistant - Height Control	•	•	•	
Battery	Dot & Dot	Carriage	Dual	351093-041	351093-041-G	Cold Storage - Water Resistant - Remote Power	•	•		•
Battery	Dot & Dot	Carriage	Dual	351093-032	351093-032-G	Dual - Cold Storage - Water Resistant - Remote Power	•	•		•
Battery	Line	Carriage	Single	351093-001	351093-001-G	Basic Std				
Battery	Line	Carriage	Single	351093-003	351093-003-G	Height Control			•	
Battery	Line	Carriage	Single	351093-019	351093-019-G	Height Control - Water Resistant	•		•	
Battery	Line	Carriage	Single	164440-002	351093-024-G	Water Resistant (deutsch connectors)	•			
Battery	Line	Carriage	Single	351093-030	351093-030-G	Water Resistant	•			•
Battery	Line	Fork Mount	Single	351093-007	351093-007-G	Basic Std				
Battery	Line	Fork Mount	Single	351093-008	351093-008-G	Water Resistant	•			
Battery	Line	Fork Mount	Single	351093-009	351093-009-G	Height Control			•	
Battery	Line	Fork Mount	Single	351093-036	351093-036-G	Height Control - Water Resistant	•		•	
Battery	Line	Fork Mount	Single	351093-037	351093-037-G	Basic -Remote Power				•
Battery	Line	Fork Mount	Single	351093-038	351093-038-G	Water Resistant - Remote Power	•			•
Battery	Line	Fork Mount	Single	351093-025	351093-025-G	Water Resistant - 1 ³ / ₄ "	•			
Battery	Line & Dot	Carriage	Dual	351093-004	351093-004-G	Basic Std				
Battery	Line & Dot	Carriage	Dual	351093-006	351093-006-G	Height Control			•	
Battery	Line & Dot	Carriage	Dual	351093-031	351093-031-G	Dual - Remote Power				•
Battery	Line & Dot	Fork Mount	Dual	351093-040	351093-040-G	Basic-Remote Power				•
Hard Wired	Dot	Carriage	Single	351093-012-D	351093-012-D-G	Basic Std				
Hard Wired	Dot	Carriage	Single	351093-013-D	351093-013-D-G	Cold Storage - Water Resistant	•	•		
Hard Wired	Dot	Carriage	Single	351093-014-D	351093-014-D-G	Height Control			•	
Hard Wired	Dot	Carriage	Single	351093-015-D	351093-015-D-G	Cold Storage - Water Resistant - Height Control	•	•	•	
Hard Wired	Dot	Carriage	Single	351093-033-D	351093-033-D-G	Hard Wired - Cold Storage - Water Resistant - Remote Power	•	•		•
Hard Wired	Dot	Carriage	Single	351093-021-D	351093-021-D-G	Basic - Remote Power				•
Hard Wired	Dot & Dot	Carriage	Dual	351093-017	351093-017-G	Cold Storage - Water Resistant	•	•		
Hard Wired	Dot & Dot	Carriage	Dual	351093-035	351093-035-G	Dual - Cold Storage - Water Resistant - Remote Power	•	•		•
Hard Wired	Line	Carriage	Single	164440-001	351093-042-G	Basic Std (deutsch connectors)				
Hard Wired	Line	Carriage	Single	164440-002	351093-024-G	Water Resistant (deutsch connectors)	•			
Hard Wired	Line	Carriage	Single	351093-012	351093-012-G	Basic Std				
Hard Wired	Line	Carriage	Single	351093-013	351093-013-G	Water Resistant	•			
Hard Wired	Line	Carriage	Single	351093-014	351093-014-G	Height Control			•	
Hard Wired	Line	Carriage	Single	351093-015	351093-015-G	Height Control - Water Resistant	•		•	
Hard Wired	Line	Carriage	Single	351093-021	351093-021-G	Basic - Remote Power				•
Hard Wired	Line	Carriage	Single	351093-033	351093-033-G	Hard Wired - Water Resistant - Remote Power	•			•
Hard Wired	Line & Dot	Carriage	Dual	351093-016	351093-016-G	Basic Std				
Hard Wired	Line & Dot	Carriage	Dual	351093-018	351093-018-G	Height Control			•	
Hard Wired	Line & Dot	Carriage	Dual	351093-034	351093-034-G	Dual - Remote Power				•

▲WARNING: Cancer and reproductive harm - www.P65Warnings.ca.gov

QuickPick® Remote

Transceiver Gloves

Part Number	Sales Unit	Size	Transceiver Module Placemet
152892-009	1 pair	Small	Left hand
152892-010	1 pair	Medium	Left hand
152892-004	1 pair	Large	Left hand
152892-005	1 pair	X-Large	Left hand
152892-006	1 pair	XX-Large	Left hand
152892-007	1 pair	Small	Right hand
152892-008	1 pair	Medium	Right hand
152892-001	1 pair	Large	Right hand
152892-002	1 pair	X-Large	Right hand
152892-003	1 pair	XX-Large	Right hand



Note: Transceiver module sold separately.



Transceiver Module

Part Number	Description
161080-001	Straight
161080-002	Coiled

Transceiver Trigger

Part Number
161070

Replacement strap: P.N. 149634



Charging Kit

Part Number
149946



Accommodates six transceiver modules. Charging, ready, and fault indicator lights. Recharges 80 percent discharged battery in six to eight hours.



Transceiver Strap Kits

162588

Part Number	Description
156885	Transceiver strap assembly - freezer condition
162588	Transceiver strap assembly

Includes coiled Go Button assembly, finger strap, wrist strap, and transceiver module frame.

Replacement parts: Finger Strap - Freezer Condition (P.N. 152687); Finger Strap (P.N. 162587); Wrist Strap (P.N. 162586; Transceiver Module Frame (P.N. 151739)

Forklift Covers & Enclosures

Soft Cab

- Protect your largest investment and keep your product moving with Crown's C-5 Series with soft cab.
- Durable modular soft cabin construction.
- Soft side zipper style doors and rear window can be rolled up or down as weather conditions change.
- Options are available with a new truck purchase or as an aftermarket add-on.

Part Number	Description
154633	Safety glass windshield with wiper and washer kit
154631	Acrylic top kit
154634	Soft rear window kit
154632	Soft left and right doors kit
151482	Entry assist handle kit
151573	Harness kit

Note: Order all kits for a full cabin.



WORK ASSIST®



Forklift Enclosures - Atrium

Part Number	Description	Size
300125-001	Standard - Super Clear Vinyl	Fits up to 6,000 lbs
300125-002	Large - Super Clear Vinyl	Fits 6,000-12,000 lbs
300125-006	XL - Super Clear Vinyl	12,000 lbs+

Great for the yard and warehouse. Keeps the rain or dust away from the operator. Zippered doors can be shut or unzipped and folded back into place while working. Universal for most lifts. UV yellow inhibitor. Freeze point flexibility. Marine grade stitching. Attaches in seconds. Super clear material.

⚠️WARNING: Cancer and reproductive harm - www.P65Warnings.ca.gov



300125-003



300125-004

Forklift Cap Covers

Part Number	Description	Size
300125-003	Super Clear Tinted Vinyl	52.5" L x 46" W
300125-004	Super Clear Vinyl	40" L x 45.5" W

Attaches with built-in bungee cords; just wrap around roof poles and attach back to itself. Attaches in seconds. Fits all lifts. Super clear material. Absorbs impacts. Protection from sun (tinted version only). Protection from rain and falling debris. Great for all warehouses and yards.

⚠️WARNING: Cancer and reproductive harm - www.P65Warnings.ca.gov



Forklift Storage Cover

Part Number	Description	Size
300125-005	Forklift Storage Cover	Fits up to 8,000 lbs 100"L x 45"W x 80"H

⚠️WARNING: Cancer and reproductive harm - www.P65Warnings.ca.gov

Battery Monitoring Identification Device

Ensures Optimum Charging to Protect Batteries

The Battery Monitoring Identification Device (BMID) Features:

- Automatically configures to the correct charge curve to match the battery size
- Measures and records DC amps during charge and discharge cycles
- Battery temperature sensing throughout the charge cycle to monitor and adjust the charge profile as needed
- Electrolyte level monitoring will signal an alarm if the water level is low
- Midpoint voltage sensing option to initiate an auto equalization based on the condition of the battery voltage
- Bluetooth for wireless download of charge events



With Access to Expanded Reporting Through the BMID, You Can View:

- Lifetime data of your batteries
- Charging history
- Alarm history
- Equalization cycles



**INTELLIGENT
CONTROL**



**LONGER
BATTERY LIFE**

Section 7

InfoLink[®], PTH 50, Chain, Forks and Attachment Parts

Contents

InfoLink [®]	7.02
Crown PTH 50 Series Pallet Truck	7.05
Crown PTH 50S/PS Series Pallet Truck	7.06
Leaf Chain	7.07
Roller Chain	7.08
Fork Pin Kits	7.08
Forks	7.09
Fork Extensions	7.11
Magnetic Fork Covers	7.11
Fork Attachments	7.12
Cascade OEM Parts	7.13
Rightline Fork Assemblies	7.17
Rightline Cross Reference	7.18

Note: 1910.178(q)(5) (1998) of the Occupational Safety and Health Act (OSHA) requires that "All parts of any such industrial truck requiring replacement shall be replaced only by parts equivalent as to safety with those used in the original design."

The installation onto a lift truck of non-certified electronic components may invalidate a truck's UL EE or LPS listing and could pose a safety risk. Customers with UL-listed lift trucks are solely responsible for ensuring compliance with UL for field modifications. The selection of non-OEM parts is made solely by the customer with the awareness that OEM parts are available. Crown Equipment Corporation is unaware of what testing and/or certification, if any, the non-OEM parts have undergone and disclaims all warranties and representations regarding any non-OEM part.

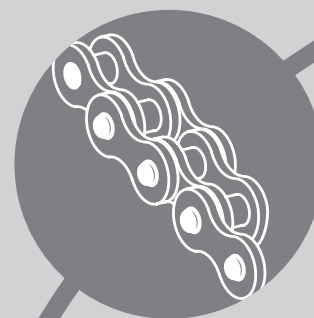

Make your Connection



7" Touch Display



3" Display

SAFETY	Complete electronic pre-shift inspections, manage operator certifications and monitor impacts	●	●
PRODUCTIVITY	Compare operator or team activity to department/shift benchmarks, identify long-term and seasonal trends	●	●
UPTIME	Schedule planned maintenance and communicate maintenance issues	●	●
ASSET MANAGEMENT	Manage individual lift truck assets or entire fleet across multiple locations	●	●
COST REDUCTION	Prevent expensive repairs, reduce damage from impacts and avoid regulatory penalties	●	●
TOUCH USER INTERFACE WITH WIDGETS		●	
SAFETY REMINDERS AND CHECKLIST IMAGES		●	

InfoLink Services: Achieve More With Your Connection

Crown's InfoLink Services can help provide the additional support needed to ensure your success. Supplemental services include those designed to help you create a solid foundation, data integration assistance with other platforms and additional customizations as you continue your InfoLink journey.

- Prepare your team for the InfoLink system with the **RightStart™** program that tailors the implementation process to meet your operational needs.
- Re-energize your organization with InfoLink using additional support programs by assessing your company's current state of InfoLink usage and customizing a plan to boost engagement.
- Integrate InfoLink data into your business systems through **InfoLink Data Services**.
 - KPI Connect – time clock, WMS, LMS
 - Maintenance Connect – hour meter data
 - Human Resource Connect – employee and certification data
 - FleetSTATS® – fleet maintenance management system
- Optimize your InfoLink experience with Custom Reporting that provides the analytics you need in a format and frequency that fits your business.

We make it easy to leverage Crown's extensive fleet management expertise by utilizing our InfoLink Services.

Contact your local Crown retailer today for an on-site business review and make the most of your connections.

Visit crown.com



7" Touch Display

Part Number	Description
165616-002-0S	7" Touch Display (USB-C port)
162136-010-0S	Rear Housing (for PN 161035-001)
167975-010	Rear Housing (for PN 167975-010-0S)
164592-001	Tablet Housing Clamp Kit
159605	Display Harness
159618-001	Short CAN T-harness
159618-002	Long CAN T-harness
164714-001	Tablet Battery
060064-029	Security Screw
164461-001	Tablet Screen Protector



Note: Experienced personnel is recommended for installation. For assistance call InfoLink help line @ 419-629-3771.
*Battery (P.N. 164714-001) not included. Needs to be ordered separately.

Prox Reader



HD Multi-Class Prox Reader

Part Number	Description
066077	3" module
159170-001	7" module

Allows operators to log into equipment using existing HID compatible badges, fobs, or stickers.



HID Card

Part Number - 340086

Used to log into InfoLink Modules with Multi-Class Prox Reader.



HID Sticker

Part Number - 340087

HID sticker can be placed on the back of existing non-HID badges to log into InfoLink modules with Multi-Class Reader.



ioProx Proximity Card Reader

Part Number - H52718-501

Allows operators to log into equipment using existing ioProx compatible badges, fobs, or stickers.

Mounting



CG CD InfoLink Clamp Kit

Part Number - 330145

Standard clamp needed for installing the InfoLink module to the front OHG.



Ram Mount OHG Clamp

Part Number - 160249-001

Fits on square rails up to 4" wide and 2 1/8" deep. Can fit much smaller rails by angling. 1 1/2" ball.

Used with RAM Mount kit to mount a module to equipment with a rectangular OHG.



Ram Mount Kit

Part Number - 157698-001

Includes: One double socket arm, two round bases, one clamp plate & hardware. Used on non-Crown equipment to mount InfoLink module.



Work Assist Clamp

Part Number - 130145

Standard clamp for Crown trucks with round OHG.

Support Tools & Parts



External Power Supply

Part Number - 390001

Allows the InfoLink module to be plugged into a 110V outlet for configuration and troubleshooting.



Power Management Module

Part Number - 008279

Used to power an InfoLink module on a non-Crown IC truck with a 12V starter battery.

Strobe & Alarm

Part Number - 157208-002

Optional audible alarm and strobe can be activated when impacts occur; to increase operator awareness and safety.

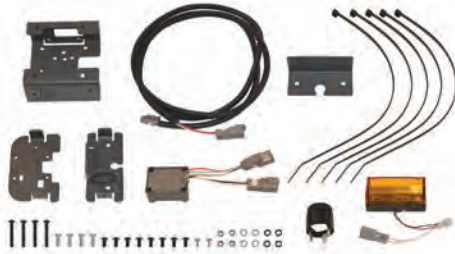

Impact Sensor

Part Number - 170051-001

Used with InfoLink to detect impacts to equipment.



Peak Dongle

Part Number - 062915-00S

Cable used to program InfoLink modules using a laptop and appropriate software.

3 Ways to Save with **Pre-Assembled Wheels** from Crown.

See Section 11

- 100 SERIES** Light Duty
- 200 SERIES** Midrange
- 300 SERIES** High Capacity
- 400 SERIES** Heavy Duty

- 1 Lower Maintenance Labor Cost**
- 2 Minimize Operator Downtime**
- 3 Reduce Parts Inventory**

Crown PTH 50S/PS Series Pallet Truck

Crown's PTH 50S/PS hand pallet truck with manual or powered scissor lift improves operator comfort and efficiency by avoiding unnecessary bending and lifting that can cause strains and stresses on the body.

- Use as a hand pallet truck and mobile work positioner
- Handle skids and open-bottom containers
- Transport loads, use as a worktable and feed printing or punch presses, as well as conveyors

Standard features

- Ergonomic handle
- Three-position control lever (raise, lower and neutral) is easily actuated with one finger
- 200° steer angle for maneuvering in tight areas
- One-piece formed C-channel steel, reinforced forks for maximum strength and longer life
- Heavy-duty, solid steel scissor legs
- Two stabilizer supports disengage the steer wheels at lift height of approximately 15" (400 mm) to prevent unexpected truck movement



Specifications	Imperial	Metric	Imperial	Metric
Manufacturer	Crown Equipment Corporation			
Scissor Lift Model	PTH50S		PTH50PS-1	
Power, Hydraulic	Manual		Manual/Electric	
Load Capacity	2200 lbs.	1000 kg	2200 lbs.	1000 kg
Load Center	23.6"	600 mm	23.6"	600 mm
Fork Length	45.3"	1150 mm	45.3"	1150 mm
Overall Length	62.8"	1595 mm	65"	1650 mm
Outside Fork Spread	21.25"/27.0"	540/685 mm	21.25/27.00"	540/685 mm
Fork Width	6.3"	160 mm	6.3"	160 mm
Fork Height Lowered	3.35"	85 mm	3.35"	85 mm
Fork Height Raised	31.3"	795 mm	31.3"	795 mm
Steer Angle	200°		200°	
Ground Clearance	0.67"	17 mm	0.67"	17 mm
Poly Steer Wheels	7.1" x 2.0"	180 x 50 mm	7.1" x 2.0"	180 mm x 50 mm
Poly Load Wheels - Single	2.9" x 2.95"	74 x 75 mm	2.9" x 2.95"	74 mm x 75 mm
Truck Weight	330/348 lbs.	150/158 kg	429/445 lbs.	195/202 kg

PTH50S Model

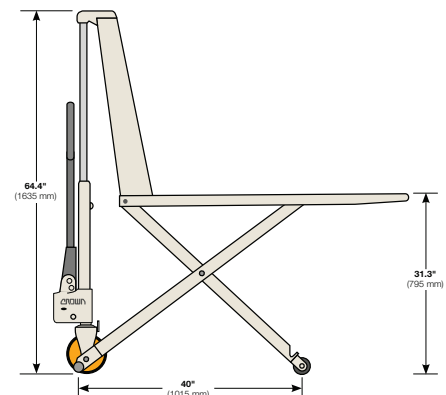
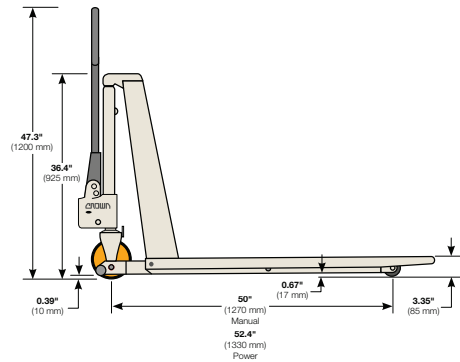
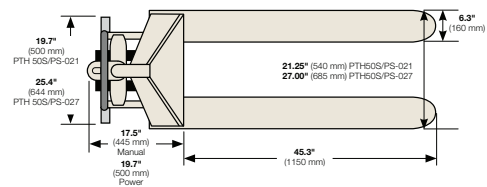

Replacement Parts

Item Description	Part Number	
	50S	50PS
Load Wheel	044512	044512
Steer Wheel - Gray	044496	044496
Steer Wheel - Orange	818270	818270
Bearing Load or Steer	065081-020	065081-020
Pump Assembly	150124	150125
Control Handle	143722	818106
Control Handle Decal	869290	869290

Leaf Chain

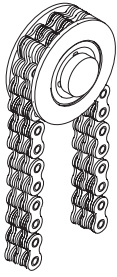

Specifications

Base Number	Type	Lacing	ANSI Number	Pitch in / mm	Ultimate Strength Minimum lb / kg
120191*	B	2 x 2	BL422	0.500 / 13	5,000 / 2,267
090738	B	2 x 3	BL523	0.625 / 16	9,000 / 4,082
083633	B	3 x 4	BL534	0.625 / 16	11,000 / 4,989
342908	B	4 X 4	BL544	0.625 / 16	15,000 / 6,803
342909	B	4 X 6	BL546	0.625 / 16	15,000 / 6,803
073991	B	3 x 4	BL634	0.750 / 19	20,400 / 9,253
342907 (was 042907)	B	4 x 4	BL644	0.750 / 19	26,000 / 11,793
103267	B	2 x 2	BL822	1.000 / 25	20,500 / 9,298
340834	B	3 X 4	BL834	1.000 / 25	28,500 / 12,928
089260	B	4 x 4	BL844	1.000 / 25	40,000 / 18,144

Order Lengths by Part Number

Base Number	10 ft box	15 ft box	20 ft box	25 ft box	28 ft box
	305 cm	457 cm	610 cm	762 cm	853 cm
083633	083633-010	083633-011	083633-012	083633-013	
342908	342908-010	342908-015	342908-020		
342909	342909-010	342909-015			
073991	073991-122	073991-123	073991-124	073991-024	073991-073
342907 (was 042907)		342907-015			
103267	103267-020	103267-021	103267-022		
089260	089260-080	089260-081	089260-082	089260-083	
Base Number	30 ft box	37 ft box	50 ft box	100 ft reel	400 ft reel
	914 cm	1,128 cm	1,524 cm	3,048 cm	12,192 cm
083633			083633-014	083633-015	
342908				342908-100	
342909				342909-100	
073991		073991-076		073991-100	073991-400
342907 (was 042907)	342907-030			342907-100	
103267					
340834				340834-100	
089260				089260-085	

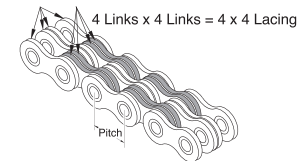
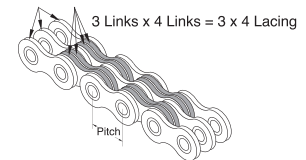
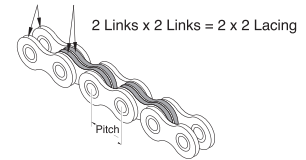

► Bulk Order Numbers - 090738-030

Use zinc-plated chain 089260-146 for corrosive environments

* 120191 sold in lengths -001 92.5", -003 102.5", -004 107.5", -005 56.5"

Chains Cut to Lengths Available*

Part Number	Plate Lacing	ANSI Number	Pitch (Inches)	Tensile Strength (lbs.)	Connecting Link
380103-534	4x4	AL644	0.75	18,000	
380103-535	6x6	AL866	1.00	48,100	380101-244
380103-532	6x6	AL1066	1.25	69,200	380101-243
380103-533	6x6	AL1266	1.50	96,300	
380103-554	4x6	BL446	0.50	12,200	
380103-559	6x6	BL566	0.63	21,000	380101-255
380103-561	2x3	BL623	0.75	13,600	380101-256
380103-564	4x6	BL646	0.75	27,200	380101-259
380103-565	6x6	BL666	0.75	35,000	380101-260
380103-567	2x3	BL823	1.00	23,000	380101-261
380103-570	4x6	BL846	1.00	46,100	380101-264
380103-571	6x6	BL866	1.00	53,100	380101-244
380103-537	2x3	BL1023	1.25	32,100	
380103-538	3x4	BL1034	1.25	50,200	380101-245
380103-539	4x4	BL1044	1.25	59,000	
380103-540	4x6	BL1046	1.25	64,200	380101-246
380103-541	6x6	BL1066	1.25	82,200	380101-247
380103-542	3x4	BL1234	1.50	66,700	
380103-544	4x6	BL1246	1.50	82,300	
380103-546	3x4	BL1434	1.75	76,900	
380103-547	4x6	BL1446	1.75	104,300	

* Available only to customers in USA

Roller Chain

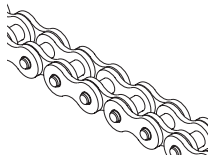

077159 Pre-packaged Service Chain Lengths (ANSI Chain Number 40, Pitch 0.5 in/13 mm)

Part Number	Length			Packaging	Links	Connecting Links Included
	in	ft	cm			
367159-004	47.5	3.96	120.65	Bag	95	x
367159-005	59.5	4.96	151.13	Bag	119	x
367159-010	120	10	304.8	Box	240	x
367159-100	1200	100	3050	Reel	2400	

078833 Pre-packaged Service Chain Lengths (ANSI Chain Number 50, Pitch 0.6 in/16 mm)

078833S002	36.87	3.08	93.66	Bag	59	x
------------	-------	------	-------	-----	----	---

132751 Pre-packaged Service Chain Lengths (ANSI Chain Number 80H, Pitch 1.0 in/25.4 mm)

332751-010	120	10	304.8	Box	120	x
------------	-----	----	-------	-----	-----	---

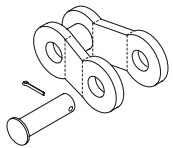

Offset Link

Part Number	ANSI Chain Number	Pitch in / mm
076902-002	40	0.5 / 13
076902-004	50	0.6 / 16

Chain Wear Scale

Part Number - 106440

Used to check leaf and roller chain wear used for lift and steering functions.

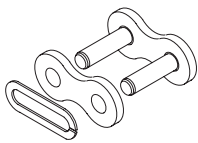

Connecting Link

Part Number	ANSI Chain Number	Pitch in / mm
076902-001	40	0.5 / 13
076902-003	50	0.6 / 16
076902-005	80	1.0 / 25

Did you know?

Highly-stressed precision chains require periodic maintenance to deliver maximum service life. After every 250 hours of truck operation, lift chains should be inspected and lubricated. Inspect chains every 50 hours if in corrosive environment. When chains have elongated 3%, they should be replaced.



Premium Chain and Cable Lube

Part Number 363115-001 | **Sales Unit** Net wt 12 oz Can
Superior, non-gumming premium oil that penetrates and lubricates all types of chains and cables. Prevents wear and rust. Loosens rusty nuts. Goes on clean, not running or dripping. Extension tube included.

Chain Wear Gauge

Part Number - 306440

Measures chain from 3/8" up to 3" pitch chain; measures wear in % increments; allows user to track wear at each inspection; limits visual errors; easy to follow instructions included.



Fork Pin Kits



390004-001 Class II

OEM / Number	OEM / Number
CA 7000034	TY A000009261
CA CCK2PKR-M	YT 04640-U201071
CA K2PKR-M	YT 55829000
CL 932775	YT 055829000
HY 1477241	YT 504236267
HY 1500773	YT 522520001
HY 1523735	YT 580016784
RA 811-885	YT 580026744
TY A000002859	YT 580035002

390004-002 Class III

OEM / Number	OEM / Number
CA 7000035	HY 369796
CA CC-K3PKR	KN K3PKR-M
CA CC-K3PKRM	KO K3PKR-M
CA CCK480	KO K3PKR
CA FPK-4736	KO 8772139
CA K3PKR	KO 8777178
CA K3PKR-M	MB A000002860
CA K480	MB A000009262
CA K485	NI CK908250
CT A0000-09262	TY A000002860
CT A000002860	TY A000009262
CT A000009262	YT 504236277
CL 908250	YT 519479802
CL 919405	YT 522520002
CL 932776	YT 580016734
HY 0369796	YT 580016740
HY 1500774	YT 580035017
HY 1523739	



103442 Class II

OEM / Number
AC 4933021
BK 101A
CL 999783
HY 3010780
HY 3027923
HY 3131893
RA 811-815-001
SC 31-90210
YT 220015615
YT 220023493
YT 519476805

111582 Class III

OEM / Number

WARNING: Cancer and reproductive harm - www.P65Warnings.ca.gov

Fork Dimensions

Note: Dimensional diagram applies to all ITA Class II and III forks.

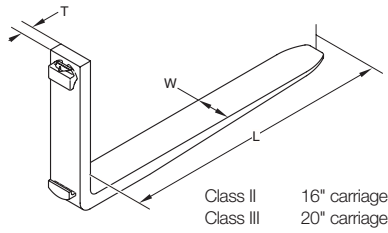

Did you know?

Orange fork tip indicators enhance visibility and productivity, while reducing damage potential. Only Crown's are recessed during the forging process which ensures Crown's will last much longer than the painted forks. These forks are fully compliant with ISO and ASME standards.

Fork Tip Indicator Labels

P.N. 396538



Fork Tip Indicator Labels

P.N. 396539



Fork Flags

P.N. 320304

Used when the forks are raised to alert personnel and prevent foot traffic underneath forks for maintenance. Orange vinyl, printed with the Crown lift trucks logo. Magnetic attachment. Flag dimensions: 900mm x 100 mm. Sold by the pair.



Partial Taper

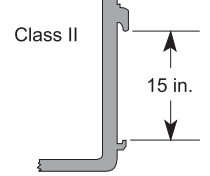
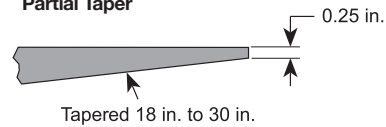

Full Taper

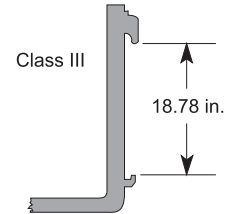
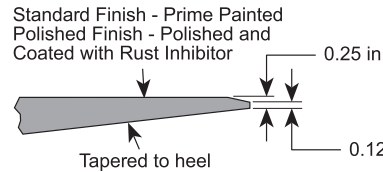

See Work Assist section for Fork Laser Guides. Available in red or green.



ITA Class II Forks (Standard Finish, Partial Taper)

Dimensions T x W x L - in	Dimensions T x W x L - mm	Capacity lb / kg	Part Number
1.5 x 4 x 30	40 x 100 x 760	3000 / 1361	160422-030
1.5 x 4 x 36	40 x 100 x 915	3000 / 1361	160422-036
1.5 x 4 x 39	40 x 100 x 990	3000 / 1361	160422-039
1.5 x 4 x 42	40 x 100 x 1065	3000 / 1361	160422-042
1.5 x 4 x 42	40 x 100 x 1065	3000 / 1361	152758*
1.5 x 4 x 45	40 x 100 x 1145	3000 / 1361	160422-045
1.5 x 4 x 48	40 x 100 x 1220	3000 / 1361	160422-048
1.5 x 4 x 54	40 x 100 x 1370	3000 / 1361	160422-054
1.5 x 4 x 60	40 x 100 x 1525	3000 / 1361	160422-060
1.5 x 4 x 72	40 x 100 x 1829	3000 / 1361	160422-072

1.75 x 4 x 30	45 x 100 x 760	5000 / 2268	160427-030
1.75 x 4 x 31.50	45 x 100 x 800	5000 / 2268	160427-031
1.75 x 4 x 36	45 x 100 x 915	5000 / 2268	160427-036
1.75 x 4 x 39	45 x 100 x 990	5000 / 2268	160427-039
1.75 x 4 x 40	45 x 100 x 1015	5000 / 2268	160427-040
1.75 x 4 x 42	45 x 100 x 1065	5000 / 2268	094182-003
1.75 x 4 x 42	45 x 100 x 1065	5000 / 2268	152759*
1.75 x 4 x 43.31	45 x 130 x 1100	5000 / 2268	160427-043
1.75 x 4 x 45	45 x 100 x 1145	5000 / 2268	160427-045
1.75 x 4 x 48	45 x 100 x 1220	5000 / 2268	160427-048
1.75 x 4 x 48	45 x 100 x 1220	5000 / 2268	152762*
1.75 x 4 x 54	45 x 100 x 1370	5000 / 2268	160427-054
1.75 x 4 x 60	45 x 100 x 1525	5000 / 2268	160427-060
1.75 x 4 x 72	45 x 100 x 1829	5000 / 2268	160427-072

1.75 x 5 x 30	45 x 130 x 760	5500 / 2495	160432-030
1.75 x 5 x 31.50	45 x 130 x 800	5500 / 2495	160432-031
1.75 x 5 x 36	45 x 130 x 915	5500 / 2495	160432-036
1.75 x 5 x 39	45 x 100 x 990	5500 / 2495	160432-039
1.75 x 5 x 42	45 x 130 x 1065	5500 / 2495	160432-042
1.75 x 5 x 43.31	45 x 130 x 1100	5500 / 2495	160432-043
1.75 x 5 x 45	45 x 130 x 1145	5500 / 2495	160432-045
1.75 x 5 x 48	45 x 130 x 1220	5500 / 2495	160432-048
1.75 x 5 x 54	45 x 130 x 1370	5500 / 2495	160432-054
1.75 x 5 x 60	45 x 130 x 1525	5500 / 2495	160432-060
1.75 x 5 x 72	45 x 130 x 1829	5500 / 2495	160432-072

*Do not have fork tip indicators.

ITA Class II Forks (Polished Finish, Full Taper)

Dimensions T x W x L - in	Dimensions T x W x L - mm	Capacity lb / kg	Part Number
1.75 x 4 x 30	45 x 100 x 760	5000 / 2268	088228-001
1.75 x 4 x 31.50	45 x 100 x 800	5000 / 2268	160425-031
1.75 x 4 x 36	45 x 100 x 915	5000 / 2268	088228-002
1.75 x 4 x 39	45 x 100 x 990	5000 / 2268	088228-006
1.75 x 4 x 40	45 x 100 x 1015	5000 / 2268	088228-011
1.75 x 4 x 42	45 x 100 x 1065	5000 / 2268	160425-042
1.75 x 4 x 43.31	45 x 100 x 1100	5000 / 2268	160425-043
1.75 x 4 x 45	45 x 100 x 1145	5000 / 2268	088228-005
1.75 x 4 x 48	45 x 100 x 1220	5000 / 2268	088228-004
1.75 x 4 x 54	45 x 100 x 1370	5000 / 2268	088228-007
1.75 x 4 x 60	45 x 100 x 1525	5000 / 2268	160425-060
1.75 x 5 x 31.50	45 x 130 x 800	5500 / 2495	160433-031
1.75 x 5 x 36	45 x 130 x 915	5500 / 2495	160433-036
1.75 x 5 x 39	45 x 130 x 990	5500 / 2495	160433-039
1.75 x 5 x 40	45 x 130 x 1015	5500 / 2495	160433-040
1.75 x 5 x 42	45 x 130 x 1065	5500 / 2495	160433-042
1.75 x 5 x 43.31	45 x 130 x 1100	5500 / 2495	160433-043
1.75 x 5 x 45	45 x 130 x 1145	5500 / 2495	160433-045
1.75 x 5 x 48	45 x 130 x 1220	5500 / 2495	160433-048
1.75 x 5 x 54	45 x 130 x 1370	5500 / 2495	160433-054
1.75 x 5 x 60	45 x 130 x 1525	5500 / 2495	160433-060

Forks

ITA Class III Forks (Polished Finish, Full Taper)

Dimensions T x W x L - in	Dimensions T x W x L - mm	Capacity lb / kg	Part Number
1.75 x 5 x 31.50	45 x 130 x 800	6000 / 2722	160481-031
1.75 x 5 x 36	45 x 130 x 915	6000 / 2722	160481-036
1.75 x 5 x 39	45 x 130 x 990	6000 / 2722	160481-039
1.75 x 5 x 40	45 x 130 x 1015	6000 / 2722	160481-040
1.75 x 5 x 42	45 x 130 x 1065	6000 / 2722	160481-042
1.75 x 5 x 43.31	45 x 130 x 1100	6000 / 2722	160481-043
1.75 x 5 x 45	45 x 130 x 1145	6000 / 2722	160481-045
1.75 x 5 x 48	45 x 130 x 1220	6000 / 2722	160481-048
1.75 x 5 x 54	45 x 130 x 1370	6000 / 2722	160481-054
1.75 x 5 x 60	45 x 130 x 1525	6000 / 2722	160481-060

1.75 x 5 x 36	45 x 122 x 915	6500 / 2948	147262-002*
1.75 x 5 x 42	45 x 122 x 1065	6500 / 2948	147262-003*
1.75 x 5 x 48	45 x 122 x 1220	6500 / 2948	147262-004* ⚠
1.75 x 5 x 60	45 x 122 x 1525	6500 / 2948	147262-006*

⚠WARNING: Cancer and reproductive harm - www.P65Warnings.ca.gov

ITA Class III Forks (Standard Finish, Partial Taper)

Dimensions T x W x L - in	Dimensions T x W x L - mm	Capacity lb / kg	Part Number
1.75 x 5 x 31.5	45 x 130 x 800	6000 / 2722	160434-031
1.75 x 5 x 36	45 x 130 x 915	6000 / 2722	160434-036
1.75 x 5 x 39	45 x 130 x 990	6000 / 2722	160434-039
1.75 x 5 x 40	45 x 130 x 1015	6000 / 2722	160434-040
1.75 x 5 x 42	45 x 130 x 1065	6000 / 2722	160434-042
1.75 x 5 x 43.31	45 x 130 x 1100	6000 / 2722	160434-043
1.75 x 5 x 45	45 x 130 x 1145	6000 / 2722	160434-045
1.75 x 5 x 48	45 x 130 x 1220	6000 / 2722	160434-048
1.75 x 5 x 54	45 x 130 x 1370	6000 / 2722	160434-054
1.75 x 5 x 60	45 x 130 x 1525	6000 / 2722	160434-060
1.75 x 5 x 72	45 x 130 x 1830	6000 / 2722	160434-072

1.75 x 5 x 36	45 x 122 x 915	6500 / 2948	147261-002*
1.75 x 5 x 42	45 x 122 x 1065	6500 / 2948	147261-003* ⚠
1.75 x 5 x 48	45 x 122 x 1220	6500 / 2948	147261-004* ⚠
1.75 x 5 x 60	45 x 122 x 1525	6500 / 2948	147261-006* ⚠

⚠WARNING: Cancer and reproductive harm - www.P65Warnings.ca.gov

* Do Not Have Fork Tip Indicators

Fork Dimensions

Note: Dimensional diagram applies to all Stockpicker forks.

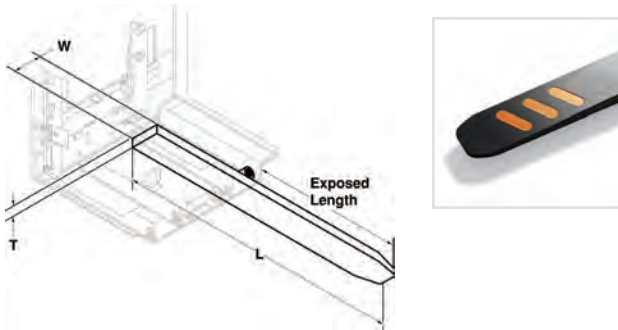

Stockpickers Manufactured (1986 to Present)

Dimensions T x W x L - in	Dimensions T x W x L - mm	Exposed Length in / mm	Part Number
2 x 4 x 60.5	50 x 100 x 1540	30 / 760	160428-030
2 x 4 x 66.5	50 x 100 x 1690	36 / 915	160428-036
2 x 4 x 69.5	50 x 100 x 1765	39 / 990	160428-039
2 x 4 x 72.5	50 x 100 x 1840	42 / 1070	160428-042
2 x 4 x 75.5	50 x 100 x 1920	45 / 1145	160428-045
2 x 4 x 78.5	50 x 100 x 1995	48 / 1220	160428-048
2 x 4 x 84.5	50 x 100 x 2145	54 / 1370	160428-054
2 x 4 x 90.5	50 x 100 x 2300	60 / 1525	160428-060
2 x 4 x 102.5	50 x 100 x 2605	72 / 1830	160428-072
2 x 4 x 114.5	50 x 100 x 2910	84 / 2135	160428-084

Stockpicker Tubular Forks (Use with Platform Load Decks)

Dimensions T x W x L - in	Dimensions T x W x L - mm	Exposed Length in / mm	Part Number
3 x 6 x 114	76 x 152 x 2900	84 / 2135	141114-001

Note: Order in pairs. Does not include mounting hardware.

TS Forks

Dimensions T x W x L - in	Dimensions T x W x L - mm	Part Number
2 x 4 x 30	50 x 100 x 760	160426-030
2 x 4 x 36	50 x 100 x 915	160426-036
2 x 4 x 37.40	50 x 100 x 950	160426-037
2 x 4 x 42	50 x 100 x 1065	160426-042
2 x 4 x 45.28	50 x 100 x 1150	160426-045
2 x 4 x 48	50 x 100 x 1220	160426-048

Note: Order in pairs. Does not include mounting hardware.

TSP/TSP 6000, 6500, 7000 Forks

Dimensions T x W x L - in	Dimensions T x W x L - mm	Part Number
1.75 x 4 x 30	44 x 102 x 760	160435-030
1.75 x 4 x 36	44 x 102 x 915	160435-036
1.75 x 4 x 37.40	44 x 102 x 950	160435-037
1.75 x 4 x 42	44 x 102 x 1065	160435-042
1.75 x 4 x 45.28	44 x 102 x 1150	160435-045
1.75 x 4 x 48	44 x 102 x 1220	160435-048

Did you know?

OSHA states that forks worn beyond 10% of their original thickness should not be returned to service.



Fork Wear Calipers

Part Number - 107330

Used to gauge minimum fork thickness and maximum bore size.

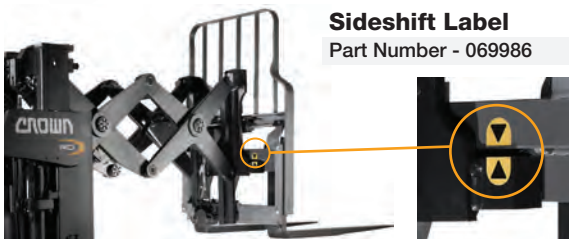

Sideshift Label

Part Number - 069986

Fork Extensions

Part Number*	Description	Weight
4" Wide Fork Extensions (Pair)*		
360039-008	54" Loop	83 lbs.
360039-009	54" Pin	83 lbs.
360039-010	63" Loop	97 lbs.
360039-011	63" Pin	97 lbs.
360039-012	72" Loop	113 lbs.
360039-013	72" Pin	113 lbs.
360039-014	84" Loop	130 lbs.
360039-015	84" Pin	132 lbs.
360039-016	96" Loop	149 lbs.
360039-017	96" Pin	151 lbs.

Replacement Label Kit - 4" Wide Fork Extensions

360039-7394	Loop
360039-7395	Pin

Part Number*	Description	Weight
5" Wide Fork Extensions (Pair)*		
360039-018	54" Loop	92 lbs.
360039-019	54" Pin	94 lbs.
360039-020	63" Loop	108 lbs.
360039-021	63" Pin	110 lbs.
360039-022	72" Loop	123 lbs.
360039-023	72" Pin	126 lbs.
360039-024	84" Loop	144 lbs.
360039-025	84" Pin	146 lbs.
360039-026	96" Loop	165 lbs.
360039-027	96" Pin	167 lbs.

Replacement Label Kit - 5" Wide Fork Extensions

360039-7396	Loop
360039-7397	Pin

Part Number*	Description	Weight
6" Wide Fork Extensions (Pair)*		
360039-028	54" Loop	104 lbs.
360039-029	54" Pin	104 lbs.
360039-030	63" Loop	116 lbs.
360039-031	63" Pin	116 lbs.
360039-032	72" Loop	134 lbs.
360039-033	72" Pin	134 lbs.
360039-034	84" Loop	163 lbs.
360039-035	84" Pin	165 lbs.
360039-036	96" Loop	186 lbs.
360039-037	96" Pin	188 lbs.

Replacement Label Kit - 6" Wide Fork Extensions

360039-7398	Loop
360039-7399	Pin

Note: Fork extensions are labeled with fork dimensions, extension capacity, and load center. The Replacement Label Kits are available for labels that are damaged, missing, or not easily readable.

Replacement Parts for Pin Styled Fork Extenders: Lock Pin (P.N. 360039-7252), Cotter Pin (P.N. 360039-7253)

WARNING: Cancer and reproductive harm - www.P65Warnings.ca.gov

***Available only to customers in USA**

Fork extensions are lift truck attachments that increase the fork's effective length for handling oversized uniformly distributed loads. When installed, fork extensions influence the truck's capacity and therefore in accordance with the law – OSHA 1910.178, the User is to request an authorization from their local dealer for a new capacity plate for their specific truck equipped with fork extensions. Maximum uniform capacity is 4,000 lbs. evenly distributed per pair.

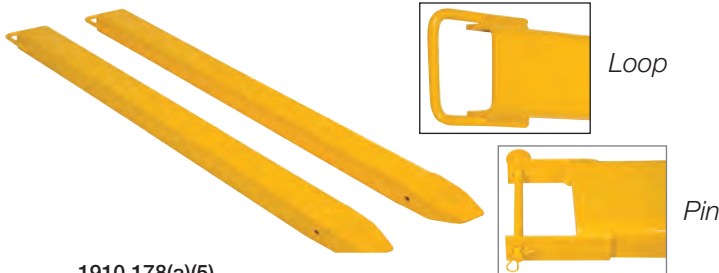

1910.178(a)(4)
Modifications and additions which affect capacity and safe operation shall not be performed by the customer or user without manufacturers prior written approval. Capacity, operation, and maintenance instruction plates, tags, or decals shall be changed accordingly.

1910.178(a)(5)
If the truck is equipped with front-end attachments other than factory installed attachments, the user shall request that the truck be marked to identify the attachments and show the approximate weight of the truck and attachment combination at maximum elevation with load laterally centered.

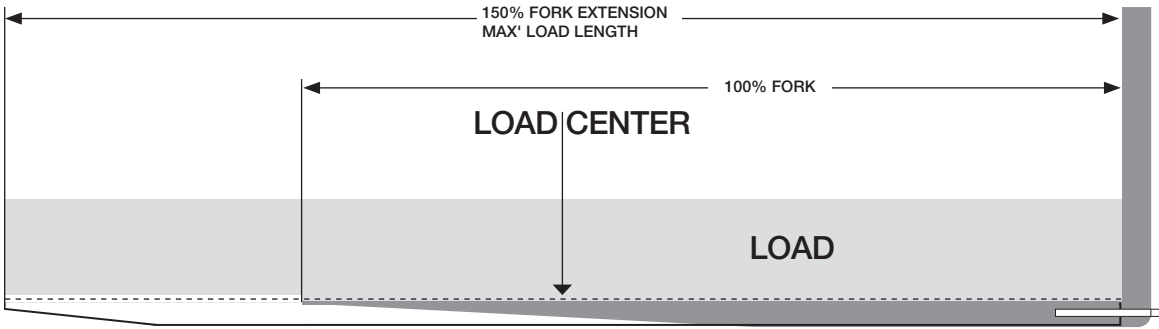

Fork extension length should not be more than 150% of supporting fork length.

Magnetic Fork Covers

- Slip Resistant Fork Covers for an Assortment of Loads**
- Easy to install and remove
 - Black rubber upper layer, a metal inner core and a magnetic bottom layer
 - Easily stores on the side of the truck when not in use

Part Number	Use w/Forks (W x L)	Thickness	Pcs	Features
360037-439	4 x 48-54"	1/4"	Pair	Covers Blade and Shank
360037-440	5 x 48-54"	1/4"	Pair	Covers Blade and Shank



WARNING: Cancer and reproductive harm - www.P65Warnings.ca.gov

Pallet Protector Pallet Dawg - Bull Dawg

Part Number	Description	Weight
351098-001	Pallet Dawg	4.825 lbs.
351098-002	Bull Dawg	5.335 lbs

Reduce Pallet and Product Damage — When damaged pallets enter your warehouse, Pallet Dawg and Bull Dawg help prevent incidental forklift contact with product. Companies that utilize these pallet protectors realize significant savings by extending the usable life of their pallets and dock equipment while reducing damage, waste and rework.



Pallet Dawg
P.N. 351098-001

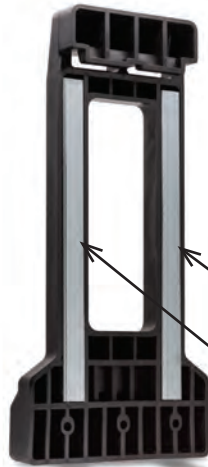

Bull Dawg
P.N. 351098-002

- Uni-body, molded construction — flexible yet rugged
- Slim, lightweight design
- Large window area — increased visibility enhances safety and convenience
- Narrow impact zone — reduce the chance for contact with product
- Beveled, contoured edges - smooth surfaces and rounded corners contact product gently
- Large radius connecting plate — rounded design enables the carriage to glide over dock plates and rack systems
- Easy assembly — three bolts and one tool
- Fits like a glove — engineered to fit **Class II carriages**
- Durable and corrosion proof — PVC plastic withstands extreme environments

Bull Dawg

- Same look and installation as the **Pallet Dawg**, the only difference is two galvanized steel bars along each side
- Ideal for high-impact and rigorous applications
- Super tough in severe cold environments

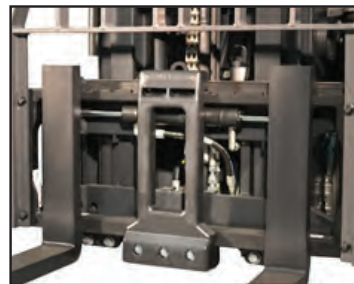
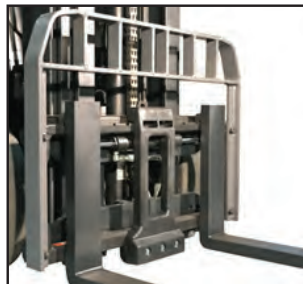

These devices will increase the horizontal load center dimension shown on the forklifts capacity plate. Crown recommends contacting the factory for an updated capacity plate. On Crown products, the Pallet Dawg and Bull Dawg will decrease the rated capacity approximately 50-100 lb. (25-50kg).

Major Components



Arm
 Part Number - 360036-243
 ▼ OEM Reference
 CA 204604
 ⚠️ **WARNING:** Cancer and reproductive harm - www.P65Warnings.ca.gov



Frame
 Part Number - 360036-572
 ▼ OEM Reference
 CA 6056651
 ⚠️ **WARNING:** Cancer and reproductive harm - www.P65Warnings.ca.gov



Frame
 Part Number - 360036-237
 ▼ OEM Reference
 CA 6018494
 ⚠️ **WARNING:** Cancer and reproductive harm - www.P65Warnings.ca.gov



Bumper
 Part Number - 360036-273
 ▼ OEM Reference
 CA 671545
 ⚠️ **WARNING:** Cancer and reproductive harm - www.P65Warnings.ca.gov

Contact Pads & Wear Strips



Contact Pad
 Part Number - 360036-144
 Used on 15D & 25D Series Carton Clamps
 ▼ OEM Reference
 CA 6057565
 ⚠️ **WARNING:** Cancer and reproductive harm - www.P65Warnings.ca.gov



Contact Pad
 Part Number - 360036-024
 Used on 15D, 25D, & 30E Series Carton Clamps
 ▼ OEM Reference
 CA 221510
 ⚠️ **WARNING:** Cancer and reproductive harm - www.P65Warnings.ca.gov



Contact Pad
 Part Number - 360036-062
 Used on 15D & 25D Series Carton Clamps
 ▼ OEM Reference
 CA 222703
 ⚠️ **WARNING:** Cancer and reproductive harm - www.P65Warnings.ca.gov

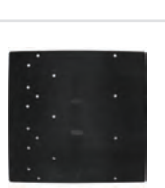

Contact Pad
 Part Number - 360036-143
 Used on AED Special Design Unit
 ▼ OEM Reference
 CA 222369
 ⚠️ **WARNING:** Cancer and reproductive harm - www.P65Warnings.ca.gov



Contact Pad
 Part Number - 360036-170
 Used on 40D Series TurnAFork
 ▼ OEM Reference
 CA 669712
 ⚠️ **WARNING:** Cancer and reproductive harm - www.P65Warnings.ca.gov



Rubber Wear Strip
 Part Number - 360036-257
 ▼ OEM Reference
 CA 6091922
 ⚠️ **WARNING:** Cancer and reproductive harm - www.P65Warnings.ca.gov



Contact Pad
 Part Number - 360036-114
 Used on 15D & 25D Series Carton Clamps
 ▼ OEM Reference
 CA 6057565
 ⚠️ **WARNING:** Cancer and reproductive harm - www.P65Warnings.ca.gov



Pad - Gripper
 Part Number - 360036-018
 ▼ OEM Reference
 CA 672712
 ⚠️ **WARNING:** Cancer and reproductive harm - www.P65Warnings.ca.gov



Rubber Wear Strip
 Part Number - 360036-162
 ▼ OEM Reference
 CA 6014935
 ⚠️ **WARNING:** Cancer and reproductive harm - www.P65Warnings.ca.gov



Wear Pad
 Part Number - 360036-128
 ▼ OEM Reference
 CA 6154691
 ⚠️ **WARNING:** Cancer and reproductive harm - www.P65Warnings.ca.gov



Wear Strip
 Part Number - 360036-258
 ▼ OEM Reference
 CA 379439
 ⚠️ **WARNING:** Cancer and reproductive harm - www.P65Warnings.ca.gov

Cylinders & Seal Kits



Cylinder

Part Number - 360036-182

▼ OEM Reference
CA 671573

▲WARNING: Cancer and reproductive harm - www.P65Warnings.ca.gov



**Cylinder Assembly
Cascade 44**

Part Number - 126841-002

▼ OEM Reference
CA 6025686

▲WARNING: Cancer and reproductive harm - www.P65Warnings.ca.gov



**Cylinder Assembly
Cascade 34.5, 38**

Part Number - 126841-001

▼ OEM Reference
CA 6025684

▲WARNING: Cancer and reproductive harm - www.P65Warnings.ca.gov



Rod Seal Service Kit

Part Number - 126903

▼ OEM Reference
CA 219868

▲WARNING: Cancer and reproductive harm - www.P65Warnings.ca.gov



Reel Hose

Part Number - 105500

▼ OEM Reference
CA 679534

▲WARNING: Cancer and reproductive harm - www.P65Warnings.ca.gov



Seal Kit

Part Number - 360036-086

▼ OEM Reference
CA 667995

▲WARNING: Cancer and reproductive harm - www.P65Warnings.ca.gov



Cylinder

Part Number - 360036-241

▼ OEM Reference
CA 671570

▲WARNING: Cancer and reproductive harm - www.P65Warnings.ca.gov



**Seal Kit -
Side Shift Cylinder**

Part Number - 360036-069

▼ OEM Reference
CA 668021

▲WARNING: Cancer and reproductive harm - www.P65Warnings.ca.gov



Spanner Wrench

Part Number - 360037-5698

For use on SR5000, ESR5200 Griptech fork cylinders, and TSP7000 KOOL fork cylinders.

▲WARNING: Cancer and reproductive harm - www.P65Warnings.ca.gov

Hoses



Hose

Part Number - 360036-108

▼ OEM Reference
CA 683173

▲WARNING: Cancer and reproductive harm - www.P65Warnings.ca.gov



Hose

Part Number - 360036-104

▼ OEM Reference
CA 685831

▲WARNING: Cancer and reproductive harm - www.P65Warnings.ca.gov

Bearings



Bearing Guide
Part Number - 390002-009
▼ OEM Reference
CA 667663
⚠️ **WARNING:** Cancer and reproductive harm - www.P65Warnings.ca.gov



Lower Bearing
Part Number - 390002-007
▼ OEM Reference
CA 208858
⚠️ **WARNING:** Cancer and reproductive harm - www.P65Warnings.ca.gov



Upper Bearing
Part Number - 390002-006
▼ OEM Reference
CA 208857
⚠️ **WARNING:** Cancer and reproductive harm - www.P65Warnings.ca.gov



Upper/Lower Bearing Kit
Part Number - 390002-008
▼ OEM Reference
CA 681749
⚠️ **WARNING:** Cancer and reproductive harm - www.P65Warnings.ca.gov

Hooks



Hook
Part Number - 360036-029
▼ OEM Reference
CA 675514
⚠️ **WARNING:** Cancer and reproductive harm - www.P65Warnings.ca.gov



Lower Bronze Hook
Part Number - 390002-002
▼ OEM Reference
CA 228165
⚠️ **WARNING:** Cancer and reproductive harm - www.P65Warnings.ca.gov



Hook Lower
Part Number - 116875
▼ OEM Reference
CA 204186
⚠️ **WARNING:** Cancer and reproductive harm - www.P65Warnings.ca.gov



Lower Hook Service Kit
Part Number - 126901
▼ OEM Reference
CA 204182
⚠️ **WARNING:** Cancer and reproductive harm - www.P65Warnings.ca.gov

Hardware



Bell Crank Assembly
Part Number - 360036-461
▼ OEM Reference
CA 672043
⚠️ **WARNING:** Cancer and reproductive harm - www.P65Warnings.ca.gov



Bushing
Part Number - 360036-009
▼ OEM Reference
CA 200590
⚠️ **WARNING:** Cancer and reproductive harm - www.P65Warnings.ca.gov



Pin
Part Number - 360036-014
▼ OEM Reference
CA 210161
⚠️ **WARNING:** Cancer and reproductive harm - www.P65Warnings.ca.gov



Pin
Part Number - 360036-004
▼ OEM Reference
CA 678832
⚠️ **WARNING:** Cancer and reproductive harm - www.P65Warnings.ca.gov



Eye Pin
Part Number - 360036-003
▼ OEM Reference
CA 6020429
⚠️ **WARNING:** Cancer and reproductive harm - www.P65Warnings.ca.gov



Pop Rivet
Part Number - 360036-010
▼ OEM Reference
CA 667843
⚠️ **WARNING:** Cancer and reproductive harm - www.P65Warnings.ca.gov



Capscrew
Part Number - 360036-001
▼ OEM Reference
CA 768706
⚠️ **WARNING:** Cancer and reproductive harm - www.P65Warnings.ca.gov



Capscrew
Part Number - 360036-049
▼ OEM Reference
CA 211180
⚠️ **WARNING:** Cancer and reproductive harm - www.P65Warnings.ca.gov

Cascade OEM Parts

Hardware (continued)



Cap screw
 Part Number - 360036-017
 ▼ OEM Reference
 CA 200173
 ⚠️ **WARNING:** Cancer and reproductive harm - www.P65Warnings.ca.gov



Cap screw
 Part Number - 360036-007
 ▼ OEM Reference
 CA 4674
 ⚠️ **WARNING:** Cancer and reproductive harm - www.P65Warnings.ca.gov



Cap screw
 Part Number - 360036-044
 ▼ OEM Reference
 CA 787372
 ⚠️ **WARNING:** Cancer and reproductive harm - www.P65Warnings.ca.gov



Locknut
 Part Number - 360036-006
 ▼ OEM Reference
 CA 550218
 ⚠️ **WARNING:** Cancer and reproductive harm - www.P65Warnings.ca.gov



Nut
 Part Number - 094004
 ▼ OEM Reference
 CA 553857
 ⚠️ **WARNING:** Cancer and reproductive harm - www.P65Warnings.ca.gov



Shim Kit
 Part Number - 360036-134
 ▼ OEM Reference
 CA 6088014
 ⚠️ **WARNING:** Cancer and reproductive harm - www.P65Warnings.ca.gov



Washer
 Part Number - 360036-092
 ▼ OEM Reference
 CA 667910
 ⚠️ **WARNING:** Cancer and reproductive harm - www.P65Warnings.ca.gov



Washer
 Part Number - 360036-011
 ▼ OEM Reference
 CA 675620
 ⚠️ **WARNING:** Cancer and reproductive harm - www.P65Warnings.ca.gov



Warning Decal
 Part Number - 146788
 ▼ OEM Reference
 CA 221906
 ⚠️ **WARNING:** Cancer and reproductive harm - www.P65Warnings.ca.gov



Cap screw
 Part Number - 360036-090
 ▼ OEM Reference
 CA 684659
 ⚠️ **WARNING:** Cancer and reproductive harm - www.P65Warnings.ca.gov



Cap screw
 Part Number - 360036-052
 ▼ OEM Reference
 CA 200504
 ⚠️ **WARNING:** Cancer and reproductive harm - www.P65Warnings.ca.gov



Cap screw
 Part Number - 360036-005
 ▼ OEM Reference
 CA 787375
 ⚠️ **WARNING:** Cancer and reproductive harm - www.P65Warnings.ca.gov



Nut
 Part Number - 360036-015
 ▼ OEM Reference
 CA 683170
 ⚠️ **WARNING:** Cancer and reproductive harm - www.P65Warnings.ca.gov



Nut
 Part Number - 360036-002
 ▼ OEM Reference
 CA 773842
 ⚠️ **WARNING:** Cancer and reproductive harm - www.P65Warnings.ca.gov



Washer
 Part Number - 116876
 ▼ OEM Reference
 CA 667225
 ⚠️ **WARNING:** Cancer and reproductive harm - www.P65Warnings.ca.gov



Washer
 Part Number - 360036-081
 ▼ OEM Reference
 CA 787398
 ⚠️ **WARNING:** Cancer and reproductive harm - www.P65Warnings.ca.gov



Label Service Cascade SS
 Part Number - 069865
 ▼ OEM Reference
 CA 228818
 ⚠️ **WARNING:** Cancer and reproductive harm - www.P65Warnings.ca.gov

Note: More Cascade parts available; contact your dealer.

ITA Class II (Partial Taper)

Dimensions L x W x T - in	Dimensions L x W x T - mm	Part Number
30 x 4 x 1.5	760 x 100 x 38	157212-001
36 x 4 x 1.5	915 x 100 x 38	157212-002
39 x 4 x 1.5	990 x 100 x 38	157212-003
42 x 4 x 1.5	1065 x 100 x 38	157212-004
45 x 4 x 1.5	1145 x 100 x 38	157212-005
48 x 4 x 1.5	1220 x 100 x 38	157212-006
54 x 4 x 1.5	1370 x 100 x 38	157212-007
60 x 4 x 1.5	1525 x 100 x 38	157212-008
30 x 4 x 1.75	760 x 100 x 45	157212-009
36 x 4 x 1.75	915 x 100 x 45	157212-010
39 x 4 x 1.75	990 x 100 x 45	157212-011
42 x 4 x 1.75	1065 x 100 x 45	157212-012
45 x 4 x 1.75	1145 x 100 x 45	157212-013
48 x 4 x 1.75	1220 x 100 x 45	157212-014
54 x 4 x 1.75	1370 x 100 x 45	157212-015
60 x 4 x 1.75	1525 x 100 x 45	157212-016
30 x 5 x 1.75	760 x 130 x 45	157212-025
36 x 5 x 1.75	915 x 130 x 45	157212-026
39 x 5 x 1.75	990 x 130 x 45	157212-027
42 x 5 x 1.75	1065 x 130 x 45	157212-028
45 x 5 x 1.75	1145 x 130 x 45	157212-029
48 x 5 x 1.75	1220 x 130 x 45	157212-030
54 x 5 x 1.75	1370 x 130 x 45	157212-031
60 x 5 x 1.75	1525 x 130 x 45	157212-032

ITA Class II (Full Taper)

Dimensions L x W x T - in	Dimensions L x W x T - mm	Part Number
30 x 4 x 1.75	760 x 100 x 45	157212-017
36 x 4 x 1.75	915 x 100 x 45	157212-018
39 x 4 x 1.75	990 x 100 x 45	157212-019
42 x 4 x 1.75	1065 x 100 x 45	157212-020
45 x 4 x 1.75	1145 x 100 x 45	157212-021
48 x 4 x 1.75	1220 x 100 x 45	157212-022
54 x 4 x 1.75	1370 x 100 x 45	157212-023
60 x 4 x 1.75	1525 x 100 x 45	157212-024
30 x 5 x 1.75	760 x 130 x 45	157212-033
36 x 5 x 1.75	915 x 130 x 45	157212-034
39 x 5 x 1.75	990 x 130 x 45	157212-035
42 x 5 x 1.75	1065 x 130 x 45	157212-036
45 x 5 x 1.75	1145 x 130 x 45	157212-037
48 x 5 x 1.75	1220 x 130 x 45	157212-038
54 x 5 x 1.75	1370 x 130 x 45	157212-039
60 x 5 x 1.75	1525 x 130 x 45	157212-040

ITA Class III (Partial Taper)

Dimensions L x W x T - in	Dimensions L x W x T - mm	Part Number
30 x 5 x 1.75	760 x 130 x 45	157212-041
36 x 5 x 1.75	915 x 130 x 45	157212-042
39 x 5 x 1.75	990 x 130 x 45	157212-043
42 x 5 x 1.75	1065 x 130 x 45	157212-044
45 x 5 x 1.75	1145 x 130 x 45	157212-045
48 x 5 x 1.75	1120 x 130 x 45	157212-046
54 x 5 x 1.75	1370 x 130 x 45	157212-047
60 x 5 x 1.75	1525 x 130 x 45	157212-048

ITA Class III (Full Taper)

Dimensions L x W x T - in	Dimensions L x W x T - mm	Part Number
30 x 5 x 1.75	760 x 130 x 45	157212-049
36 x 5 x 1.75	915 x 130 x 45	157212-050
39 x 5 x 1.75	990 x 130 x 45	157212-051
42 x 5 x 1.75	1065 x 130 x 45	157212-052
45 x 5 x 1.75	1145 x 130 x 45	157212-053
48 x 5 x 1.75	1220 x 130 x 45	157212-054
54 x 5 x 1.75	1370 x 130 x 45	157212-055
60 x 5 x 1.75	1525 x 130 x 45	157212-056

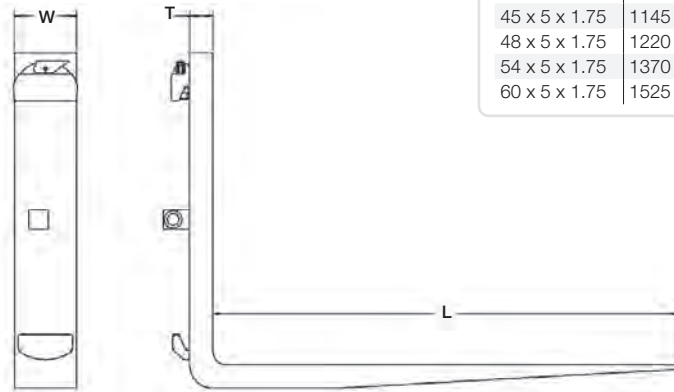

Crown is Your One-Stop Shop

Personal Protective Equipment

Fall Protection Equipment

Including harnesses and lanyards

Safety Apparel

Including ear and eye protection, face shields, safety vests, coveralls and hard hats

Respiratory Equipment

Including respirators and masks

See Safety Equipment Section



Seat Belts

Including retractable belts, high visibility safety orange and standard color belts in a variety of lengths and styles

First Aid Kits

Including those for minor injuries and high risk work zones

one
source
LIFT TRUCK PARTS

Rightline Part Number	Crown Part No.	Description
004-184-040	156029	Plate
004-216	156022	Plate
004-219-125	156004	Plate
004-439-001	155999	Plate
004-495-001	155844	Plate
004-596-001	155677	Plate
004-618-001	360035-003	Plate
004-619-001	155666	Plate
005-007-001	156021	Retainer
005-206-001	155861	Retainer
005-210-001	155782	ITA Slide
005-304-001	155922	ITA Slide
005-306-001	155940	Retainer
006-130-001	155661	Hook
010-057-001	155667	Retainer
020-038-002	155961	Poly Bearing
020-038-004	155959	Poly Bearing
020-043-001	155783	Poly Bearing
020-078-001	156000	Poly Bearing
020-079-002	156001	Poly Bearing
032-063-001	155625	Plate
041-001	156020	Shim
041-022-001	155860	Shim
044-049-013	155978	Pin
044-067-001	155665	Pin
044-083-001	156017	Pin
044-084-001	156016	Pin
044-104-001	155676	Pin
046-041-001	155964	Bushing
046-057-001	360035-004	Bushing
050-001-075	155815	Spacer
052-156-007	155976	Fork Weldment
052-157-007	155977	Fork Weldment
061-097-001	155996	Hook Assembly
101-201-001	155786	Cylinder Anchor
101-279-001	155998	Cylinder Anchor
101-309-X344	155781	Cylinder Anchor
101-309-X408	155869	Cylinder Anchor
101-309-X496	156005	Cylinder Anchor
101-309-X620	156170	Cylinder Anchor
101-313-X416Y33	155921	Cylinder Anchor
101-313-X512Y33	155946	Cylinder Anchor
101-313-X592Y33	156180	Cylinder Anchor
103-107-001	155789	Cylinder Tube
103-109-001	155924	Cylinder Tube
104-057-106	155968	Cylinder Rod
104-060-003	155795	Cylinder Rod
104-106-015	156009	Cylinder Rod
104-120-194	155807	Cylinder Rod
104-120-218	155931	Cylinder Rod
104-120-222	155871	Cylinder Rod
104-120-266	155948	Cylinder Rod
104-120-270	155878	Cylinder Rod
104-120-338	156183	Cylinder Rod
104-120-342	156173	Cylinder Rod
105-002-001	156012	Cylinder Piston
105-040-001	155969	Cylinder Piston
105-064-001	155791	Cylinder Piston
105-065-001	155816	Cylinder Piston
105-066-001	155926	Cylinder Piston
106-016	155966	Cylinder Head
106-022-001	156010	Cylinder Head
106-074-001	155794	Cylinder Head
106-074-002	155793	Cylinder Head
106-075-001	155813	Cylinder Head
106-076-001	155929	Cylinder Head
106-076-002	155928	Cylinder Head
108-119-005	156013	Cylinder Tube

Rightline Part Number	Crown Part No.	Description
108-122-001	155970	Cylinder Tube
108-141-194	155810	Tube Assembly
108-141-218	155932	Tube Assembly
108-141-222	155872	Tube Assembly
108-141-266	155949	Tube Assembly
108-141-270	155879	Tube Assembly
108-141-338	156184	Tube Assembly
108-141-342	156174	Tube Assembly
114-001-001	155641	Valve Assembly
116-239-X548	155845	Hydraulic Group
116-239-X604	155873	Hydraulic Group
116-239-X700	155867	Hydraulic Group
116-239-X844	156172	Hydraulic Group
116-242-X604	155933	Hydraulic Group
116-242-X700	155950	Hydraulic Group
116-242-X844	156182	Hydraulic Group
116-277-001	155984	Hydraulic Group
119-100-001	155848	Manifold
119-119-001	155985	Manifold
119-122-001	155642	Manifold
120-049-001	155643	Fitting
120-049-002	155646	Fitting
120-049-003	155847	Fitting
120-050-003	155645	Fitting
120-050-004	155846	Fitting
120-050-007	155799	Fitting
120-051-002	155644	Fitting
120-059-001	155653	Fitting
120-065-001	155852	Fitting
120-070-002	156019	Fitting
120-080-001	155851	Fitting
120-087-001	155798	Restrictor Disc
125-003-001	155650	Cartridge Relief
125-006-002	155986	Cartridge
125-007-001	155649	Cartridge Dual Relief
125-014-001	155647	Cartridge Check Valve
125-029-001	155648	Cartridge Flow Divider
127-131-010	155989	Hydraulic Hose Group
130-006-013	155657	Hose Assembly
130-006-024	155990	Hose
130-006-041	155994	Hose
130-006-125	155656	Hose Assembly
130-006-177	155658	Hose Assembly
130-006-297	155993	Hose
130-006-331	155655	Hose Assembly
130-013-X410	155857	Hose
130-013-X438	155877	Hose
130-013-X466	155938	Hose
130-013-X486	155919	Hose
130-013-X514	155954	Hose
130-013-X540	155855	Hose
130-013-X544	155856	Hose
130-013-X558	156178	Hose
130-013-X568	155875	Hose
130-013-X586	156188	Hose
130-013-X590	155936	Hose
130-013-X600	155876	Hose
130-013-X616	155917	Hose
130-013-X620	155854	Hose
130-013-X638	155952	Hose
130-013-X676	155874	Hose
130-013-X688	156176	Hose
130-013-X696	155918	Hose
130-013-X700	155935	Hose
130-013-X710	156186	Hose
130-013-X728	155953	Hose
130-013-X772	155880	Hose
130-013-X796	155951	Hose

Rightline Part Number	Crown Part No.	Description
130-013-X840	156177	Hose
130-013-X872	156187	Hose
130-013-X916	156175	Hose
130-013-X940	156185	Hose
130-014-011	155934	Hose
130-014-017	155853	Hose
130-016-027	155991	Hose
130-016-045	155992	Hose
204-116-001	155780	Fork Positioner Frame
204-116-002	155868	Fork Positioner Frame
204-116-003	155801	Fork Positioner Frame
204-116-004	156169	Fork Positioner Frame
204-117-001	155920	Fork Positioner Frame
204-117-002	155945	Fork Positioner Frame
204-117-003	156179	Fork Positioner Frame
206-117-001	155955	Clamp Base
206-180-001	155770	Clamp Base
207-343-009	155974	Fork Arm Weldment
207-344-009	155975	Fork Arm Weldment
207-533-005	155626	Arm Weldment
210-243-005	155980	Backrest RH
210-244-005	155981	Backrest LH
210-246-001	156026	Backrest LH
210-247-001	156028	Backrest RH
210-265-001	155671	Load Backrest
217-025-002	155674	Pad Carrier
217-026-002	155675	Pad Carrier
219-262-001	155939	Mounting Group
219-263-001	155859	Mounting Group
219-276-002	155995	Mounting Group
219-305-001	155664	Mounting Group QD
227-019-005	155979	Backrest Group
227-023-001	156025	Backrest Group
275-003-001	360035-001	Wiring Harness
275-010-001	360035-002	Wiring Harness
401-018-001	155960	Roll Pin
401-019-002	155958	Roll Pin
401-023-002	155784	Roll Pin
402-016-001	155865	Lock Washer
402-016-002	155982	Lock Washer
402-016-003	156023	Lock Washer
402-016-004	155785	Lock Washer
402-016-005	155987	Lock Washer
402-016-006	155849	Lock Washer
402-017-001	155651	Lock Washer
402-017-003	360035-005	Lock Washer
402-017-004	155662	Lock Washer
402-017-006	360035-006	Lock Washer
403-028-001	360035-007	Socket Cap Screw
403-028-005	155673	Socket Cap Screw
403-032-006	360035-008	Cap Screw
403-038-004	155678	Socket Cap Screw
403-039-006	155997	Socket Cap Screw
403-039-008	155663	Socket Cap Screw
403-046-003	360035-009	Socket Cap Screw
405-067-003	156024	Cap Screw
405-068-001	155669	Cap Screw
405-068-002	155866	Cap Screw
405-069-008	155983	Cap Screw
405-069-012	156027	Cap Screw
405-072-004	155804	Cap Screw
405-074-001	156006	Cap Screw
405-074-004	155988	Cap Screw
405-074-008	156003	Cap Screw
405-076-004	156007	Cap Screw
405-076-005	155850	Cap Screw
406-023-001	155818	Nut
406-023-006	155787	Nut

Rightline Part Number	Crown Part No.	Description
406-023-009	155637	Nut
406-024-001	155957	Castle Nut
406-042-001	155624	Nut
407-006-002	155956	Cotter Pin
408-006-001	155803	Grease Fitting
411-001-001	155659	Cable Tie
413-021-001	155639	Bearing
431-002-001	155670	Protective Cap
900-014-001	156014	Service Kit
900-017-001	155705	Service Kit
900-049-001	155973	Service Kit
900-054-001	155819	Service Kit
900-055-001	155941	Service Kit
900-058-001	155800	Service Kit
C-2Q269	155962	Cylinder
C-2V194F	155806	Cylinder
C-2V218F	155930	Cylinder
C-2V222F	155870	Cylinder
C-2V224	360035-010	Cylinder Complete
C-2V266F	155947	Cylinder
C-2V270F	155858	Cylinder
C-2V338F	156181	Cylinder
C-2V342F	156171	Cylinder
C-3W188	360035-011	Cylinder
C-2Y437	155627	Cylinder
C-3C437	155694	Cylinder
C-635-001	155788	Cylinder
C-642-001	155923	Cylinder
C-683-001	156008	Cylinder
FEM248	155759	Fork Positioner
FEM249	155760	Fork Positioner
PFG2-18430	157212-017	Fork Assembly
PFG2-18436	157212-018	Fork Assembly
PFG2-18439	157212-019	Fork Assembly
PFG2-18442	157212-020	Fork Assembly
PFG2-18445	157212-021	Fork Assembly
PFG2-18448	157212-022	Fork Assembly
PFG2-18454	157212-023	Fork Assembly
PFG2-18460	157212-024	Fork Assembly
PFG2-18530	157212-033	Fork Assembly
PFG2-18536	157212-034	Fork Assembly
PFG2-18539	157212-035	Fork Assembly
PFG2-18542	157212-036	Fork Assembly
PFG2-18545	157212-037	Fork Assembly
PFG2-18548	157212-038	Fork Assembly
PFG2-18554	157212-039	Fork Assembly
PFG2-18560	157212-040	Fork Assembly
PFG3-18530	157212-049	Fork Assembly
PFG3-18536	157212-050	Fork Assembly
PFG3-18539	157212-051	Fork Assembly
PFG3-18542	157212-052	Fork Assembly
PFG3-18545	157212-053	Fork Assembly
PFG3-18548	157212-054	Fork Assembly
PFG3-18554	157212-055	Fork Assembly
PFG3-18560	157212-056	Fork Assembly
PGR2-15439	157212-003	Fork Assembly
PGR2-15442	157212-004	Fork Assembly
PGR2-15445	157212-005	Fork Assembly
PGR2-15448	157212-006	Fork Assembly
PGR2-15454	157212-007	Fork Assembly
PGR2-15460	157212-008	Fork Assembly
PGR2-18439	157212-011	Fork Assembly
PGR2-18442	157212-012	Fork Assembly
PGR2-18445	157212-013	Fork Assembly
PGR2-18448	157212-014	Fork Assembly
PGR2-18454	157212-015	Fork Assembly
PGR2-18460	157212-016	Fork Assembly
PRG2-15430	157212-001	Fork Assembly

Rightline Part Number	Crown Part No.	Description
PRG2-15436	157212-002	Fork Assembly
PRG2-18430	157212-009	Fork Assembly
PRG2-18436	157212-010	Fork Assembly
PRG2-18530	157212-025	Fork Assembly
PRG2-18536	157212-026	Fork Assembly
PRG2-18539	157212-027	Fork Assembly
PRG2-18542	157212-028	Fork Assembly
PRG2-18545	157212-029	Fork Assembly
PRG2-18548	157212-030	Fork Assembly
PRG2-18554	157212-031	Fork Assembly
PRG2-18560	157212-032	Fork Assembly
PRG3-18530	157212-041	Fork Assembly
PRG3-18536	157212-042	Fork Assembly
PRG3-18539	157212-043	Fork Assembly
PRG3-18542	157212-044	Fork Assembly
PRG3-18545	157212-045	Fork Assembly
PRG3-18548	157212-046	Fork Assembly
PRG3-18554	157212-047	Fork Assembly
PRG3-18560	157212-048	Fork Assembly

Check out Crown's selection of aerosols. See Section 1.



Section 8

Battery and Charger

Contents

Battery Room Checklist	8.02
V-Force Industrial Battery Chargers	8.03
Charger Stands	8.06
Charger Accessories	8.08
Battery Chargers	8.10
Charger Cords	8.12
Battery Cable Assemblies	8.13
V-Force® Marketing Support Materials	8.15
V-Force® Industrial Lithium-Ion Batteries	8.16
V-Force® Industrial Lead-Acid Batteries	8.17
V-Force® Lithium Compact Batteries	8.18
V-Force® Deep Cycle Batteries	8.18
V-Force® Starter Batteries	8.19
V-Force® Battery Display Rack	8.19
V-Force® Retail Mobility Cart Batteries	8.20
Battery Cross Reference	8.20
Rescue Jump Packs	8.22
Battery Watering Application Chart & Systems	8.23
Float Systems	8.24
Watering Gun	8.27
Float System Supplies & Parts	8.28
Float System Kits & Parts	8.31
Battery Watering Injector System	8.32
Battery Accessories	8.37
Battery Repair Parts	8.38
Leadhead Shrouds & Intercell Connectors	8.38
Safety Boots/Protective Caps	8.41
Battery Connectors	8.41
Power Cable & Accessories	8.46
Battery Acid Indicators	8.47
Battery Tools	8.47
Battery Service Supplies	8.51

New Items:

V-HFM³ Single Phase Charger - p 8.03
V-HFE³ Single Phase Charger - p 8.05
Charger Cords - p 8.12
Lithium Ion Charge Harnesses - p 8.13
Cable Assemblies - p 8.14
Low Pressure Regulator - p 8.29
BWT Grey Male Connector - p 8.30
Blue Dust Cap - p 8.41
Cable 4/0 Red UL-100FT - p 8.46
Smart Blinky with Flexitap - p 8.47
5,000 Capacity Sling - p 8.50

Note: 1910.178(q)(5) (1998) of the Occupational Safety and Health Act (OSHA) requires that "All parts of any such industrial truck requiring replacement shall be replaced only by parts equivalent as to safety with those used in the original design."

The installation onto a lift truck of non-certified electronic components may invalidate a truck's UL EE or LPS listing and could pose a safety risk. Customers with UL-listed lift trucks are solely responsible for ensuring compliance with UL for field modifications. The selection of non-OEM parts is made solely by the customer with the awareness that OEM parts are available. Crown Equipment Corporation is unaware of what testing and/or certification, if any, the non-OEM parts have undergone and disclaims all warranties and representations regarding any non-OEM part.

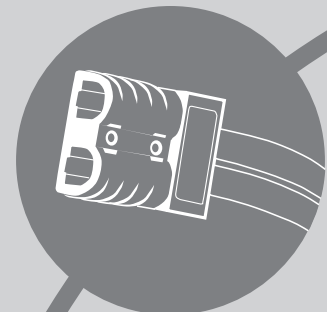

Thank you for allowing me to conduct a survey of your current forklift battery charging and maintenance resources. The items noted below are products we recommend you consider adding or updating within your current charging area to help support proper battery maintenance, charging and safe handling. These products and many more parts and supplies can be found in the attached One Source Lift Truck Parts Catalog.

If you have any questions regarding these recommendations, or about placing an order with Crown Equipment, please contact me:

Name _____

Phone _____

Email _____

BATTERY SERVICE SUPPLIES

Part No.	Description
<input type="checkbox"/> 079528	Koorsen 2.5 lb. Fire Extinguisher, ABC*
<input type="checkbox"/> 365466	NuTend 16 Gallon Eye Wash Station*
<input type="checkbox"/> 365474	Water Additive, Case/12*
<input type="checkbox"/> 365468	ProWorks® Eye Wash Station, 1 kit*
<input type="checkbox"/> 365469-001	ProWorks® Replacement Bottle of Eye Wash*
<input type="checkbox"/> 300035	Battery Spill Kit*
<input type="checkbox"/> 365260-001	Apron, Black*
<input type="checkbox"/> 300042	Faceshield, Clear*
<input type="checkbox"/> 300041	Headgear*
<input type="checkbox"/> 300044	Acid Resistant Glove, Green*
<input type="checkbox"/> 300403-050	Reusable Battery Acid Floor and Counter Mat, 3 ft. x 50 ft.*
<input type="checkbox"/> 300421	Battery Protector® Acid Spill Absorber and Neutralizer, 5 gal.*
<input type="checkbox"/> 300421-030	Battery Protector® Acid Spill Absorber and Neutralizer, 30 gal.*
<input type="checkbox"/> 363124-001	Crown Battery Cleaner, 18 oz.
<input type="checkbox"/> 363125-001	Crown Battery Protector, 14 oz.
<input type="checkbox"/> 363133-001	QuickCable Black Battery Reconditioner, 12 oz.

* Strongly suggested per OSHA standards

CHARGER ACCESSORIES

Part No.	Description
<input type="checkbox"/> 169244-001	Rail Stop
<input type="checkbox"/> 396568	Magnet Mount Cable Holder
<input type="checkbox"/> 168175-001	Battery Pogo Stick, 39 in.
<input type="checkbox"/> 168284-001	Tender Kit
<input type="checkbox"/> 300460	Short L-Bracket for Racking
<input type="checkbox"/> 168283-001	Pogo Stick L Mounting Bracket
<input type="checkbox"/> 300038-005	Tool Balance Swivel Mount
<input type="checkbox"/> 396625-001	Retractor w/ Grommet
<input type="checkbox"/> 168176-002	HD Pogo Stick w/ Tender Kit

WATERING GUN

Part No.	Description
<input type="checkbox"/> 300236	V-Force® Battery Watering Gun

FLOAT SYSTEM - FILL OPTIONS

Part No.	Description
<input type="checkbox"/> 300224-147	120 V AC 10 Gallon Watering Cart
<input type="checkbox"/> 300224-090	120 V DC 10 Gallon Watering Cart
<input type="checkbox"/> 300226-005	V-Force® Water Deionizer

BATTERY ACID INDICATORS

Part No.	Description
<input type="checkbox"/> 340011-012	Smart Blinky Pro, 2.35 in.
<input type="checkbox"/> 340011-015	Smart Blinky Pro, 5 in.
<input type="checkbox"/> 340011-007	Blinky, 2.35 in.
<input type="checkbox"/> 340011-008	Blinky, 5 in.
<input type="checkbox"/> 340011-009	Smart Blinky, 2.35 in.
<input type="checkbox"/> 340011-010	Smart Blinky Remote, 2.35 in.
<input type="checkbox"/> 340011-011	Smart Blinky, 5 in.

BATTERY MANAGEMENT SYSTEM

Part No.	Description
<input type="checkbox"/> 340640	V-Force® Small Fleet BMS Controller
<input type="checkbox"/> 300314-SU6	Sentinel with Blue Light

SAFETY BOOTS

Part No.	Description
<input type="checkbox"/> 300413-050	V-Force® Safety Boot, SB, 50 A
<input type="checkbox"/> 300413-175	V-Force® Safety Boot, SB, 175 A
<input type="checkbox"/> 300413-350	V-Force® Safety Boot, SB, 350 A
<input type="checkbox"/> 300462-175	V-Force® Safety Boot, SBX, 175 A
<input type="checkbox"/> 300462-350	V-Force® Safety Boot, SBX, 350 A



HFM³ Single Phase Series



Features

- Multi-voltage and multi amp hr
- Capable of Conventional, Opportunity, and V-Force Lithium-Ion profiles
- Auto equalization by cycles or date/time
- 100-277V Single Phase Charger
- Accessory Capable (with Expansion Board)
- WIFI/Ethernet Ready
- Optional Current sensing BMID available
- Downloadable event log - up to 10,000 events
- Marks of Conformity - UL Listed, cUL Listed, CEC-BC Compliant
- Mounting bracket included
- Warranty - 2 year full plus 1 year parts
- Lead-Acid and Lithium-Ion Capable
- Multi-voltage charge capacity: charges 12V, 24V, 36V, and 48V
- Output options of 48A, 85A, 120A, and 240A

Model Number	Cabinet Size	Max Current	DC Voltage	Amp Hour Range Conventional	Amp Hour Range Opportunity	AC Input	Max Weight (lbs.)	Cabinet Size
FS1-MP142-048	FS1	48	24	75-300	50-175	100V-277V	20.80	12.83 x 4.25 x 15.90
	FS1	32	36	75-200	50-100	100V-277V	20.80	
	FS1	24	48	75-150	50-75	100V-277V	20.80	
FS1-MP142-085	FS1	85	24	75-500	50-325	100V-277V	23.40	12.83 x 4.25 x 15.90
	FS1	56	36	75-350	50-225	100V-277V	23.40	
	FS1	42	48	75-250	50-150	100V-277V	23.40	
FS1-MP142-120	FS1	120	24	75-750	50-475	100V-277V	26.00	12.83 x 4.25 x 15.90
	FS1	80	36	75-500	50-300	100V-277V	26.00	
	FS1	60	48	75-375	50-225	100V-277V	26.00	
FS1-MP142-240	FS1	240	24	75-1500	50-950	100V-277V	37.80	12.83 x 8.11 x 15.90
	FS1	160	36	75-1000	50-625	100V-277V	37.80	
	FS1	120	48	75-750	50-475	100V-277V	37.80	

Note: For additional information, please reference the brochure and price pages available through your local Crown dealer or the Partner Site.

⚠ WARNING: Cancer and reproductive harm - www.P65Warnings.ca.gov

BATTERY AND CHARGER



HFM³ Triple Phase Series



HFM³ FS3

Features

- Modular design
- Reliable and redundant
- Multi voltage and multi amp hr
- Capable of Conventional, Opportunity, Fast or V-Force Lithium-ion profiles
- Lithium ready option
- Auto equalization by cycles or date/time
- Accessory Capable (with Expansion Board)
- WIFI/Ethernet ready
- Optional current sensing BMID available
- Downloadable event log - up to 10,000
- Marks of Conformity - UL Listed, cUL Listed, CEC-BC Compliant
- Mounting bracket included
- Warranty - 2 years full plus 1 year parts
- V-HFM³ FS6 - dual cable

Note: For additional information, please reference the brochure and price pages available through your local Crown dealer or the Partner Site.



Model Number	Cabinet Size	No. of Modules	Max Current	DC Voltage	Amp Hour Range Conventional	Amp Hour Range Opportunity	Amps Output Lithium-Ion	Phase	AC Input	Max Weight (lbs.)
FS3-MP342-1	FS3	1	100	24, 36	300 - 625	300 - 400	100	3	208, 240	27
	FS3	1	85	48	300 - 525	300 - 325	85	3	208, 240	27
FS3-MP342-2	FS3	2	200	24, 36	300 - 1250	300 - 800	200	3	208, 240	32.2
	FS3	2	170	48	300 - 1050	300 - 675	170	3	208, 240	32.2
	FS3	2	100	72, 80	300 - 625	300 - 400	100	3	208, 240	32.2
	FS3	2	84	96	300 - 500		84	3	208, 240	32.2
FS3-MP342-3	FS3	3	300	24, 36	300 - 1875	300 - 1200	300	3	208, 240	37.4
	FS3	3	255	48	300 - 1575	300 - 1000	255	3	208, 240	37.4
	FS3	3	150	72, 80	300 - 925	300 - 600	150	3	208, 240	37.4
	FS3	3	126	96	300 - 750	300 - 500	126	3	208, 240	37.4
FS3-MP344-1	FS3	1	100	24, 36	300 - 625	300 - 400	100	3	480	27
	FS3	1	85	48	300 - 525	300 - 325	85	3	480	27
	FS3	1	50	72, 80			50	3	480	27
	FS3	1	42	96			42	3	480	27

Continued ▶

V-HFM³ Series

Model Number	Cabinet Size	No. of Modules	Max Current	DC Voltage	Amp Hour Range Conventional	Amp Hour Range Opportunity	Amp Hour Range Fast	Amps Output Lithium-Ion	Phase	AC Input	Max Weight (lbs.)
FS3-MP344-2	FS3	2	200	24, 36	300 - 1250	300 - 800	300 - 500	200	3	480	32.2
	FS3	2	170	48	300 - 1050	300 - 675	300 - 425	170	3	480	32.2
	FS3	2	100	72, 80	300 - 625	300 - 400		100	3	480	32.2
	FS3	2	84	96	300 - 500			84	3	480	32.2
FS3-MP344-3	FS3	3	300	24, 36	300 - 1875	300 - 1200	300 - 750	300	3	480	37.4
	FS3	3	255	48	300 - 1575	300 - 1000	300 - 625	255	3	480	37.4
	FS3	3	150	72, 80	300 - 925	300 - 600		150	3	480	37.4
	FS3	3	126	96	300 - 750	300 - 500		126	3	480	37.4
FS4-MP344-4	FS4	4	400	24, 36		300 - 1600		400	3	480	61.1
	FS4	4	340	48	300 - 1875	300 - 1350		340	3	480	61.1
	FS4	4	200	72, 80	300 - 1250	300 - 800		200	3	480	61.1
	FS4	4	168	96	300 - 1050	300 - 350		168	3	480	61.1
FS4-MP344-5	FS4	5	400	48				400	3	480	66.3
	FS4	5	250	72, 80	300 - 1550	300 - 1000		250	3	480	66.3
	FS4	5	210	96	300 - 1300	300 - 825		210	3	480	66.3
FS4-MP344-6	FS4	6	300	72, 80	300 - 1875	300 - 1200		300	3	480	71.5
	FS4	6	252	96	300 - 1575	300 - 1000		252	3	480	71.5
FS6-MP344-4	FS6	4	400	24, 36			300 - 1000		3	480	61.1
	FS6	4	340	48			300 - 850		3	480	61.1
	FS6	4	200	72, 80			300 - 500		3	480	61.1
	FS6	4	168	96			300 - 400		3	480	61.1
FS6-MP344-5	FS6	5	500	24, 36			300 - 1250		3	480	66.3
	FS6	5	425	48			300 - 1050		3	480	66.3
	FS6	5	250	72, 80			300 - 625		3	480	66.3
	FS6	5	210	96			300 - 525		3	480	66.3
FS6-MP344-6	FS6	6	600	24, 36			300 - 1500		3	480	71.5
	FS6	6	510	48			300 - 1275		3	480	71.5
	FS6	6	300	72, 80			300 - 750		3	480	71.5
	FS6	6	252	96			300 - 625		3	480	71.5
FS3-MP346-1	FS3	1	100	24, 36	300 - 625	300 - 400		100	3	600	27
	FS3	1	85	48	300 - 525	300 - 325		85	3	600	27
	FS3	1	50	72, 80				50	3	600	27
	FS3	1	42	96				42	3	600	27
FS3-MP346-2	FS3	2	200	24, 36	300 - 1250	300 - 800	300 - 500	200	3	600	32.2
	FS3	2	170	48	300 - 1050	300 - 675	300 - 425	170	3	600	32.2
	FS3	2	100	72, 80	300 - 625	300 - 400		100	3	600	32.2
	FS3	2	84	96	300 - 500			84	3	600	32.2
FS3-MP346-3	FS3	3	300	24, 36	300 - 1875	300 - 1200	300 - 750	300	3	600	37.4
	FS3	3	255	48	300 - 1575	300 - 1000	300 - 625	255	3	600	37.4
	FS3	3	150	72, 80	300 - 925	300 - 600		150	3	600	37.4
	FS3	3	126	96	300 - 750	300 - 500		126	3	600	37.4
FS4-MP346-4	FS4	4	200	72, 80	300 - 1250	300 - 800		200	3	600	61.1
	FS4	4	168	96	300 - 1050	300 - 650	300-650	168	3	600	61.1
FS4-MP346-5	FS4	5	400	48				400	3	600	66.3
	FS4	5	250	72, 80	300 - 1550	300 - 1000		250	3	600	66.3
	FS4	5	210	96	300 - 1300	300 - 825		210	3	600	66.3
FS4-MP346-6	FS4	6	300	72, 80	300 - 1875	300 - 1200		300	3	600	71.5
	FS4	6	252	96	300 - 1575	300 - 1000		252	3	600	71.5
FS6-MP346-4	FS6	4	400	24, 36			300 - 1000		3	600	61.1
	FS6	4	340	48			300 - 850		3	600	61.1
	FS6	4	200	72, 80			300 - 500		3	600	61.1
	FS6	4	168	96			300 - 400		3	600	61.1
FS6-MP346-5	FS6	5	500	24, 36			300 - 1250		3	600	66.3
	FS6	5	425	48			300 - 1050		3	600	66.3
	FS6	5	250	72, 80			300 - 625		3	600	66.3
	FS6	5	210	96			300 - 525		3	600	66.3
FS6-MP346-6	FS6	6	600	24, 36			300 - 1500		3	600	71.5
	FS6	6	510	48			300 - 1275		3	600	71.5
	FS6	6	300	72, 80			300 - 750		3	600	71.5
	FS6	6	252	96			300 - 625		3	600	71.5

⚠ **WARNING:** Cancer and reproductive harm - www.P65Warnings.ca.gov

Note: For additional information, please reference the brochure and price pages available through your local Crown dealer or the Partner Site.



HFE³ Single Phase



Features

- High-frequency Economy Charger
- High efficiency = energy savings
- Compact and lightweight
- CE and RoHS Compliant - UL Listed
- Mounting bracket included with every charger
- Auto equalization by cycles or date/time
- Warranty - 2 year full plus 1 year parts
- Reporting capabilities
- Multiple DC voltage 12V/24V/36V/48V
- Wider AC voltage range - 100V to 277V - Single Phase
- Output options of 48A, 85A, and 120A

Model Number	Cabinet Size	DC Voltage	Max Current	Amp Hour Range Conventional	AC Input	Max Weight (lbs.)	Cabinet Size
FS1-MP142E-048	FS1	24	48	75-300	100V-277V	20.80	12.83 x 4.25 x 15.90
		36	32	75-200		20.80	
		48	24	75-150		20.80	
FS1-MP142E-085	FS1	24	85	75-500	100V-277V	23.40	12.83 x 4.25 x 15.90
		36	56	75-350		23.40	
		48	42	75-250		23.40	
FS1-MP142E-120	FS1	24	120	75-750	100V-277V	26.00	12.83 x 4.25 x 15.90
		36	80	75-500		26.00	
		48	60	75-375		26.00	

Note: For additional information, please reference the brochure and price pages available through your local Crown dealer or the Partner Site.

⚠WARNING: Cancer and reproductive harm - www.P65Warnings.ca.gov



HFE³ Triple Phase



Features

- High-frequency economy charger
- High efficiency = energy savings
- Compact and lightweight
- CE and RoHS compliant - UL Listed
- Mounting bracket included with every charger
- Warranty - 2 year full plus 1 year parts
- Reporting capabilities
- Multiple DC voltage 24/36/45V
- Higher AC voltage range - up to 600V AC

Model Number	Cabinet Size	No. of Modules	Max Current	DC Voltage	Amp Hour Range Conventional	AC Input	Max Weight (lbs.)
FS2-MP342E-1	FS3	1	100	24, 36	300 - 750	208, 240V	30
				48	300 - 650		
FS2-MP342E-2	FS3	2	200	24, 36	300 - 1375	208, 240V	34.2
				48	300 - 650		
FS2-MP344E-1	FS3	1	100	24, 36	300 - 750	480V	30
				48	300 - 50		
FS2-MP344E-2	FS3	2	200	24, 36	300 - 1375	480V	34.2
				48	300 - 650		
FS2-MP346E-1	FS3	1	100	24, 36	300 - 1250	600V	30
				48	300 - 1050		
FS2-MP346E-2	FS3	2	400	24, 36	300-1375	600V	34.2
				48	300 - 650		

Note: For additional information, please reference the brochure and price pages available through your local Crown dealer or the Partner Site.

⚠WARNING: Cancer and reproductive harm - www.P65Warnings.ca.gov

Charger Stand

For use with V-HFM, V-HFM³, V-HFE and V-HFE³

Features and Benefits

- Sleek versatile design offers multiple configuration options.
- Heavy duty steel frame construction.
- Stand securely anchors to the floor and holds chargers safely in place.
- Designed to free up valuable warehouse floor space.
- Uses mounting bracket included with charger.



Standard 55" Post

Standard 55" Post *Recommended for use with Lead Acid chargers only				
Description	Item Number	Side View	Maximum # Of Chargers	Top View

55" Post 25" Arm Single Sided	168383-055-25-1		UP TO 2	
55" Post 25" Arm Double Sided*	168383-055-25-2		UP TO 4	

*NOTE: FS3 cabinet only

Tall 84" Post

Tall 84" Post *Recommended for use with Lithium chargers, also available for Lead Acid chargers				
Description	Item Number	Side View	Maximum # Of Chargers	Top View

84" Post 25" Arm Single Sided	168383-084-25-1		UP TO 2	
84" Post 25" Arm Double Sided	168383-084-25-2		UP TO 4	

Charger Stands

Charger Stand Kits

Part Number	Description
55" Charger Stand Kits	
168383-055-18-1	55" Post, 18" Arm Single Sided
168383-055-18-2	55" Post, 18" Arm Double Sided
168383-055-25-1	55" Post, 25" Arm Single Sided
168383-055-25-2	55" Post, 25" Arm Double Sided
168383-055-37-1	55" Post, 37" Arm Single Sided
168383-055-37-2	55" Post, 37" Arm Double Sided
168383-055-50-1	55" Post, 50" Arm Single Sided
84" Charger Stand Kits	
168383-084-18-1	84" Post, 18" Arm Single Sided
168383-084-18-2	84" Post, 18" Arm Double Sided
168383-084-25-1	84" Post, 25" Arm Single Sided
168383-084-25-2	84" Post, 25" Arm Double Sided



Support Arm Kits

Part Number	Description
55" Charger Stand Support Arm Kits	
168382-055-18-1	55" 18" w/ Support Arm - Single Sided
168382-055-18-2	55" 18" w/ Support Arm - Double Sided
168382-055-25-1	55" 25" w/ Support Arm - Single Sided
168382-055-25-2	55" 25" w/ Support Arm - Double Sided
168382-055-37-1	55" 37" w/ Support Arm - Single Sided
168382-055-37-2	55" 37" w/ Support Arm - Double Sided
168382-055-50-1	55" 50" w/ Support Arm - Single Sided
84" Charger Stand Support Arm Kits	
168382-084-18-1	84" 18" w/ Support Arm - Single Sided
168382-084-18-2	84" 18" w/Support Arm - Double Sided
168382-084-25-1	84" 25" w/ Support Arm - Single Sided
168382-084-25-2	84" 25" w/ Support Arm - Double Sided

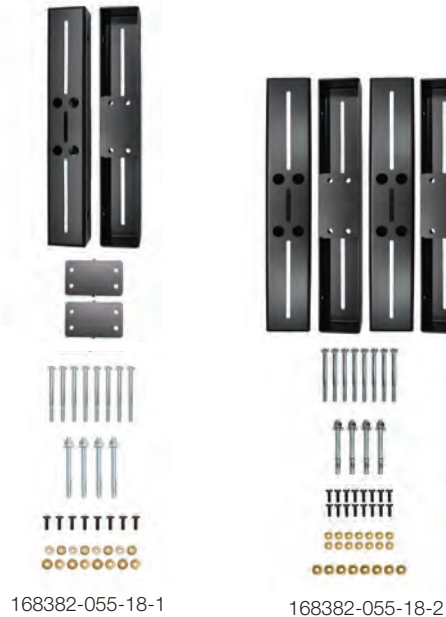

Components

Part Number	Description
163181-001	55" Post Base Stand Weldment
163181-002	84" Post Base Stand Weldment
168384-001	Bolts - 3/8" X 3
163186-001	Support Arm 18"
163186-002	Support Arm 25"
163186-003	Support Arm 37"
163186-004	Support Arm 50"
163188	Stand Clamp Plate HFM ³
060016-073	Screw 5/16
060080-007	Hex Flange Nut
060015-006	Screw 1/4
060080-006	Hex Flange Nut



Battery Monitoring Identification Device (BMID)

Part Number - 396525-BTM

- Automatically programs V-Force V-HFM/V-HFM³ chargers with the correct battery charge profile.
- Dual profile configuration to optimize battery health and SOC for opportunity or fast charging.
- Records all battery events including temperature, charge and discharge cycles.
- Current sensing up to +/- 1300 amps.
- Electrolyte level sensor.
- Temperature probe senses battery temperature throughout the complete charge cycle and adjusts the charge profile as needed.



- Larger toroid to fit 4/0 cable.
- Rugged case construction resists impact, water, and battery electrolyte spills.
- Bluetooth® Class 1 for improved range when connecting to a laptop or tablet.
- UL Classified
- Installation kit included (P.N. 396525-KIT)

Replacement parts:

Temperature Sensor - P.N. 396573;
Installation Kit - P.N. 396525-KIT

Mounting Hardware

The **Mounting Bracket** is a convenient solution for mounting charger cabinets.

V-HFM³ Mounting Bracket

Part Number - 396583

- Heavy duty steel construction supports up to 50 lbs.
- Allows the FS3 charger cabinet to be mounted from the rear, side or to stand.
- Included with every HFM³ model charger.
- Frees up floor space and keeps charger secure to prevent damage.



396583



396583-001

Part Number - 396583-001

- Included with every HFM³ FS4/FS6 charger

V-HFM and V-HFE Mounting Bracket

Part Number - 396521-001

- Included with every HFM and HFE FS3 Cabinet



396521-001

⚠️ **WARNING:** Cancer and reproductive harm - www.P65Warnings.ca.gov

Long L-Bracket is used in conjunction with a pogo stick to keep cables elevated and off the floor.

Part Number - 168283-001

- Use the longer L-bracket to mount to the wall next to the FS3 size cabinet charger.
- Can be used with both our standard and heavy duty pogo sticks.



Also available:

L-Bracket and Pogo Stick

P.N. 168176-001

L-Bracket with Heavy Duty Pogo Tender Kit

P.N. 168176-003

*Recommended for use with V-HFM³ FS3-3 models and larger.

L-Bracket includes hardware. Used to mount pogo stick to racking.

Part Number - 300460

⚠️ **WARNING:** Cancer and reproductive harm - www.P65Warnings.ca.gov

Tool Balance Swivel Mount



Part No.	Min.-Max. Load	Reel Weight	Cable Length
300038-005	3.0-5.0 lbs.	1.5 lbs.	6'

The BD Series Tool Balancer is an economical choice for balancing tools weighing up to 5 lbs. The molded ABS housing has a smooth exterior with rounded edges designed for maximum ergonomic appeal. The tool balancer is easy to adjust and reliable.

Tower Light

Part Number - 396586-001



- HFM³ LED light indicates battery charge status from a distance.
- Includes 11.81 inch pole with mounting bracket, I/O expansion board with internal wiring loom, expansion board mounting standoff and DE9 mounting standoffs.

⚠️ **WARNING:** Cancer and reproductive harm - www.P65Warnings.ca.gov

Remote Switch

Part No. Description

396587-001 Use with V-HFM³ chargers that are mounted in a location not easy to access.

Note: includes I/O Board, wiring harness and mounting hardware.

396555 Use with V-HFM chargers that are mounted in a location not easy to access.



396587-001



Replacement parts for Part No. 396587-001:

Remote control only - P.N. 396587

Remote control cable - P.N. 396587-002

⚠️ **WARNING:** Cancer and reproductive harm - www.P65Warnings.ca.gov

V-HFM and V-HFM³ USB Cables

Part No. Description

300118 USB A to Mini-B 2.0 cable for programming V-HFM Series High Frequency Chargers with Laptop.

300118-001 USB A to Micro-B 2.0 cable used for laptops and Galaxy Tables S3, S4 and S5.

300118-002 Micro USB to USB A adaptor to program V-HFM³ with tablet. **This is required for all tablets.**

300118-003 USB Type C to USB A cable used for S6 and newer tablets.

396592 V-HFM³ Accessory Cable, 3M



300118



396592

⚠️ **WARNING:** Cancer and reproductive harm - www.P65Warnings.ca.gov

Charger Accessories

Battery Pogo Stick

Part No.	Description
168175-001	Used to keep battery connectors and cables off the floor at charging stations, preventing damage and wear. 39" in length, 1" in diameter. Supports up to 10 ft of 3/0 cable.

▲ **Replacement Cable Clamp DC**
P.N. 300038-001

▲ **WARNING:** Cancer and reproductive harm - www.P65Warnings.ca.gov



V-Force Cable Retractor

Part No.	Description
171780-001	Cable Retractor
396625-001	Cable Retractor with Grommet/Cable Housing

171780-001

Balance DC charger cables or tools weighing up to 15 lbs. Spring tension adjusts easily.

396625-001

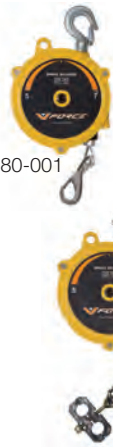

Heavy Duty Battery Pogo Stick

Part No.	Description
168175-002	Zinc plated 40". Up to 66% stronger than competitive designs. Mounting hardware included. Includes rubber grommet clamp.

Also available: Heavy Duty with Tender Kit
P.N. 168176-002 Includes Heavy Duty Pogo Stick and Tender Kit.

*Recommended for V-HFM® applications.

▲ **WARNING:** Cancer and reproductive harm - www.P65Warnings.ca.gov



Cable Retractor

Part No.	Description
300038-002	Heavy-duty cable retractor holds larger cables and is adjustable and lightweight. The retractor mounts to charger stand, shelf or wall bracket by 2 mounting holes.

▲ **WARNING:** Cancer and reproductive harm - www.P65Warnings.ca.gov



Tender Kit

Part No.	Description
168284-001	Secure large DC battery cables with or without a pogo stick. Superior strength and high performance in the most extreme applications. Heavy-duty clamp design corrosion resistant composite body. 16" single with clamp.

▲ **WARNING:** Cancer and reproductive harm - www.P65Warnings.ca.gov



Tender 3 Hole Clamp with Clip

Part No.	Description
369500	Tender 3 Hole Clamp with Clip

▲ **WARNING:** Cancer and reproductive harm - www.P65Warnings.ca.gov



Magnet Mount Cable Holder

Part No.	Description
396568	Conveniently secures battery and charger cables, preventing cable damage and clutter. Mount to any flat, ferrous metallic surface such as a charger stand, charger wall bracket, or charger case.

▲ **WARNING:** Cancer and reproductive harm - www.P65Warnings.ca.gov



Rail Stop

Part No.	Description
169244-001	The rail stop can be installed in front of existing charging stations or with the V-Force charger stand. The required anchor bolts to attach the stop to the warehouse floor are included. Dimensions: 10" H x 34" L. Weight: 34 lbs.



V-110 Portable Charger

Part Number - 390040-125-02



Features

- Auto start/stop
- 11.26" L x 7" W x 8.27" H
- 24V; 40 amps output
- Weight: 20 lbs.
- SB175 red connector attached; gray connector included
- 1-year warranty
- UL and CSA compliant
- HF Charging technology
- Single Phase AC self adjusts for 100V to 240V; 220V Euro Power
- U.S. AC Cord
- **Replacement P.N. 390040-002**
- Euro AC Cord
- **Replacement P.N. 390040-001**
- Wall mount bracket available - **P.N. 390040-BRKT**

390040-BRKT

⚠ **WARNING:** Cancer and reproductive harm - www.P65Warnings.ca.gov

On-Board Charger

Part Number - 370337



Replacement DC Output Cable: **P.N. 370337-001**

Features

- 9.1" L x 5" W x 2.98" H
- 24V; 20 amps output
- Weight: 5 lbs.
- 120Vac - 50/60Hz
- SB175 red connector
- 3-year warranty
- UL, CSA, CE and CEC compliant
- HF Charging technology

▼ **OEM Reference**

Applied Energy (Colt)	A15124	RA	939-353-286
	BT 313799-001	Zivan	NG1
	PM 313799-001	Zivan	UG1-24-30A
	RA 313799-001		

⚠ **WARNING:** Cancer - www.P65Warnings.ca.gov

Portable or On-Board - 12, 24 or 36 Volt Charger

Features

- Use with Lead Acid (Wet/AGM) batteries
- Designed for tough duty applications
- UL approved
- Exclusive temperature compensation
- Reverse polarity spark free operation
- Fan cooled
- Portable and On Board Options
- Fully automatic with float maintenance
- Made in USA



Portable
392412



On-Board
391215



On-Board
392425-OBTD

Part Number	Output Voltage	Amps	Input Voltage	Cycle	Dimensions H x W x L (in)	Connector Attached	Weight	Brand	Description
391210	12	10	120V	50-60 hz	4.75 x 8.00 x 6.38	SB50	5.5 lbs.	Sportsman Series	Portable
391215	12	15	120V	50-60 hz	5.00 x 8.25 x 6.38	Ring Terminals	7 lbs.	Professional Series	Portable
392412	24	12	120V	50-60 hz	9.75 x 8.38 x 8.25	SB50	19 lbs.	Eagle Performance Series	Portable
392425	24	25	120V	50-60 hz	9.75 x 8.38 x 8.25	SB50	19 lbs.	Eagle Performance Series	Portable
393625	36	25	120V	50-60 hz	9.75 x 8.38 x 8.25	SB50	19 lbs.	Eagle Performance Series	Portable
394815	48	15	120V	50-60 hz	8.25 x 8.38 x 9.75	SB50	19 lbs.	Eagle Performance Series	Portable
392425-OB	24	25	120V	50-60 hz	9.00 x 8.50 x 5.75	Ring Terminals	22 lbs.	Eagle Performance Series	On-Board
393625-OB	36	25	120V	50-60 hz	9.00 x 8.50 x 5.75	Ring Terminals	28 lbs.	Eagle Performance Series	On-Board
392425-OBTD*	24	25	120V	50-60 hz	5.75 x 8.50 x 12.5	Ring Terminals/ 18 AWG/14AWG/12AWG	22 lbs.	Eagle Performance Series	On-Board
393625-OBTD*	36	25	120V	50-60 hz	5.75 x 8.50 x 12.5	Ring Terminals/ 18 AWG/14AWG/12AWG	28 lbs.	Eagle Performance Series	On-Board
394818-OBTD*	48	18	120V	50-60 hz	5.75 x 8.50 x 12.5	Ring Terminals/ 18 AWG/14AWG/12AWG	28 lbs.	Eagle Performance Series	On-Board

*Replacement Charger for Taylor Dunn Carts

⚠ **WARNING:** Cancer and reproductive harm - www.P65Warnings.ca.gov

Battery Chargers



Part Number - 370349

Delta Q On-Board Charger Configurable for Flooded Lead Acid Batteries

- 9.92" L x 7.32" W x 3.15" H
- 24 Vdc
- Input voltage 85-270Vac
- Weight 6.5 lbs.

Note: AC Power Cord sold separately,
P.N. 396351

▼ OEM Reference
Delta Q IC650

Part No.	Description
165634	IC650-24-COMM-Configurable for Lithium batteries
163280	IC650
164174	IC1200

⚠ **WARNING:** Cancer and reproductive harm - www.P65Warnings.ca.gov



Part Number - 370253

Battery Charger

- 20" L x 5" W x 3.25 H"
- 24V
- 15 amps
- Weight 23 lbs.

▼ OEM Reference

RA 850-138-139-02 TY 00590-43337-71



Part Number - 370600

12V 100W Power Inverter

- Supply 115 V AC or 5V DC via USB from service van cigarette lighter
- Provide AC power to products that require 100W or less
- Swivel mounting allows for left or right adjustment
- High speed cooling fan protects from overheating

⚠ **WARNING:** Cancer and reproductive harm - www.P65Warnings.ca.gov



Part Number - 370359

Charger On-Board

- 8.5" L x 4.8" W x 2.92" H
- 24V
- 12 amps
- Weight 5 lbs.
- Includes inhibit cable that enables truck

▼ OEM Reference

HY 4023332 YT 582010485

⚠ **WARNING:** Cancer - www.P65Warnings.ca.gov



Part Number - 370252

Charger On-Board

- 11" L x 4.5" W x 7" H
- 24V
- Output amps 18
- Input voltage 120V
- Weight 20 lbs.
- Charges gel battery

▼ OEM Reference

HY 1607815	HY 4603626	YT 580055473
HY 2048079	HY 8512512	YT 580087314
HY 2054228	YT 524245865	YT 582003887
HY 2073416	YT 580029671	
HY 2102631	YT 580034920	

Charger Cords



Part Number - GN100195GT

Replacement Power Cord AC

- 6 ft. 7 in. long
- 300v
- 15 amp, 13 amp plug

▼ OEM Reference
DEKA IMP-9412

▲ WARNING: Cancer and reproductive harm - www.P65Warnings.ca.gov



Part Number - 396350

Replacement Power Cord

- 12" of straight cord on either side of 12" constricted spiral cord (60" total length)
- For Zivan charger

▼ OEM Reference
GNB V04SPRLCORD



Part Number - 126711

Replacement Charger Cord AC

- 8.2 ft. long
- 125 VAC
- 15 amp

▼ OEM Reference
DEKA IMP-9409
DEKA SA4081



Part Number - 396351

Replacement Power Cord AC

- For use with Delta Q On-Board Charger

▲ WARNING: Cancer - www.P65Warnings.ca.gov



Part Number - 142669

Replacement Power Cord

- 10 ft. long
- 300v
- 15 amp, 15 amp plug



Part Number - 396354

Replacement Power Cord

- 18" of straight cord, female end to spiral cord
- For Zivan charger

▼ OEM Reference
GNB V04ZIVANPLUG

Charger Cords

- UL Rated Cable
- Use with V-HFM³ and V-HFE³ series chargers
- Nema Rated Locking Plugs



Part Number	Description	NEMA Plug	Max Current	Max AC Voltage
171452-480-06-2	Power Cord Assembly 6' 10AWG	L16-20P	20A	480V-Triple Phase
171452-480-10-2	Power Cord Assembly 10' 10AWG	L16-20P	20A	480V-Triple Phase
171452-480-15-2	Power Cord Assembly 15' 10AWG	L16-20P	20A	480V-Triple Phase
171452-480-06-3	Power Cord Assembly 6' 10AWG	L16-30P	30A	480V-Triple Phase
171452-480-10-3	Power Cord Assembly 10' 10AWG	L16-30P	30A	480V-Triple Phase
171452-240-06-3	Power Cord Assembly 6' 10AWG	L15-30P	30A	250V-Triple Phase
171452-240-10-3	Power Cord Assembly 10' 10AWG	L15-30P	30A	250V-Triple Phase
171703-240-06-3	Power Cord Assembly 6' 10AWG	L6-30P	30A	250V-Single Phase
171703-240-10-3	Power Cord Assembly 10' 10AWG	L6-30P	30A	250V-Single Phase
171452-000-06-3	Power Cord Assembly 6' 10AWG	No Plug	30A	600V - Triple Phase
171452-000-10-3	Power Cord Assembly 10' 10AWG	No Plug	30A	600V - Triple Phase
171452-000-06-5	Power Cord Assembly 6' 8AWG	No Plug	50A	600V - Triple Phase
171452-000-10-5	Power Cord Assembly 10' 8AWG	No Plug	50A	600V - Triple Phase
171452-600-06-3	Power Cord Assembly 6' 10AWG	L17-30P	30A	600V - Triple Phase
171452-600-10-3	Power Cord Assembly 10' 10AWG	L17-30P	30A	600V - Triple Phase
171703-000-06-3	Power Cord Assembly 6' 10AWG	No Plug	30A	277V - Single Phase
171703-000-10-3	Power Cord Assembly 10' 10AWG	No Plug	30A	277V - Single Phase
171703-120-06-1	Power Cord Assembly 6' 14AWG	5-15P	15A	120V - Single Phase
171703-120-10-1	Power Cord Assembly 10' 14AWG	5-15P	15A	120V - Single Phase
171703-120-06-2	Power Cord Assembly 6' 12AWG	5-20P	20A	120V - Single Phase
171703-120-10-2	Power Cord Assembly 10' 12AWG	5-20P	20A	120V - Single Phase
171703-240-06-1	Power Cord Assembly 6' 14AWG	6-15P	15A	250V- Single Phase
171703-240-10-1	Power Cord Assembly 10' 14AWG	6-15P	15A	250V- Single Phase
171703-240-06-2	Power Cord Assembly 6' 12AWG	6-20P	20A	250V- Single Phase
171703-240-10-2	Power Cord Assembly 10' 12AWG	6-20P	20A	250V- Single Phase

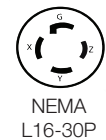

NEMA L16-30P



NEMA L15-30P

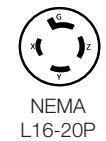

NEMA L16-20P

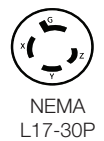

NEMA L17-30P



5-15P



5-20P



6-15P



6-20P



L6-30P

Cable Size Matrix

HFM [®] Model No.	Cable Size	Connector Options							
		175SB	350SB	175SBX	350SBX	160SBE	320SBE	A160	A320
FS3-MP342-1	1/0	X	X	X	X	X	X	X	X**
FS3-MP342-2	3/0		X		X		X		X**
FS3-MP342-3	4/0		X		X		X		X**
FS3-MP344-1	1/0	X	X	X	X	X	X	X	X**
FS3-MP344-2	3/0		X		X		X		X**
FS3-MP344-3	4/0		X		X		X		X**
FS4-MP344-4	4/0		X*						
FS4-MP344-5	4/0		X*						
FS4-MP344-6	4/0		X*						
FS4-MP346-4	4/0		X*						
FS4-MP346-5	4/0		X*						
FS4-MP346-6	4/0		X*						
FS6-MP344-4	4/0		2X		2X		2X		2X
FS6-MP344-5	4/0		2X		2X		2X		2X
FS6-MP344-6	4/0		2X		2X		2X		2X
FS1-MP142-048	2/0 or 1/0	X	X		X	X	X	X	X
FS1-MP142-085	2/0 or 1/0	X	X		X	X	X	X	X
FS1-MP142-120	2/0 or 1/0	X	X		X	X	X	X	X
FS1-MP142-240	2/0		X		X		X		X

*FS4-4, 5, 6 uses 350SB with 4/0 Crimp Lug
 **A320 is not recommended for Lithium. See Lithium Ion Charge Harness below.

HFE [®] Model No.	Cable Size	Connector Options							
		175SB	350SB	175SBX	350SBX	160SBE	320SBE	A160	A320
FS1-MP142E-048	X	X		X		X	X	X	
FS1-MP142E-085	X	X		X		X	X	X	
FS1-MP142E-120	X	X		X	X	X	X	X	

HFE Model No.	Cable Size	Connector Options							
		175SB	350SB	175SBX	350SBX	160SBE	320SBE	A160	A320
FS3-MP124-2	1/0	X	X	X	X	X	X	X	X
FS3-MP324-2	1/0	X	X	X	X	X	X	X	X
FS3-MP124-3	1/0	X	X	X	X	X	X	X	X
FS3-MP324-3	1/0	X	X	X	X	X	X	X	X
FS3-MP136-2	1/0	X	X	X	X	X	X	X	X
FS3-MP336-2	1/0	X	X	X	X	X	X	X	X
FS3-MP336-3	1/0	X	X	X	X	X	X	X	X
FS3-MP348-2	1/0	X	X	X	X	X	X	X	X
FS3-MP348-3	1/0	X	X	X	X	X	X	X	X

HFM Model No.	Cable Size	Connector Options							
		175SB	350SB	175SBX	350SBX	160SBE	320SBE	A160	A320
FS3-MP130-2	1/0	X	X	X	X	X	X	X	X
FS3-MP130-3	1/0	X	X	X	X	X	X	X	X

NOTE: 2 connector housings are required to assemble with the standard size cable and 4 connector housings with the dual (2X) cable assemblies.

Steps to determine correct cable and connector housing: **1.** Reference the Cable Size Matrix Chart to identify your charger model and the corresponding cable size. **2.** Reference the Chart to make the connector housing selection (typically customer/application specific). **3. All cable assemblies will require the recommended contact tip for the charger end and recommended connector housing for the battery end. (If dual cables are ordered for fast charging, then 2 of the connectors will be required.)** **4.** Selection of the other connector housing(s) is based on the cable specified per the customer's location. Example: FS9-MP330-8 with 350SBX (Blue) 15 ft. cable – Cable Assembly Part Number: 39653X-350-15 – qty 2; Connector Housing Part Number: 078723-001 – qty 2; 340090-002 – qty 2.



Lithium Ion Charge Harnesses

All Lithium Ion Charge Harnesses come assembled with Schaltbau LV400 and CAN Communication Line.

Harness Part Number	Cable Length	Cable	Charger Connector	Phase
164401-400-08	8 FT	4/0	SB350 GRAY	Triple
164401-400-10	10 FT	4/0	SB350 GRAY	Triple
164401-400-15	15 FT	4/0	SB350 GRAY	Triple
164401-400-20	20 FT	4/0	SB350 GRAY	Triple
164401-400-25	25 FT	4/0	SB350 GRAY	Triple
171707-175-10	10 FT	2/0	SB175 GRAY	Single
171707-175-15	15 FT	2/0	SB175 GRAY	Single
171707-175-20	20 FT	2/0	SB175 GRAY	Single
171707-175-25	25 FT	2/0	SB175 GRAY	Single

⚠️ WARNING: Cancer and reproductive harm - www.P65Warnings.ca.gov

Battery Cable Assemblies*

DC Cable Number	Cable Length	Cable Size	Contact Tips for	Contact Tips for
			Connector - Charger Connector	Connector Battery End
172385-001-08	8 ft.	1/0	SB350	SB175
172385-001-15	15 ft.	1/0	SB350	SB175
172385-001-20	20 ft.	1/0	SB350	SB175
172385-001-25	25 ft.	1/0	SB350	SB175
172385-004-08	8 ft.	1/0	SB350	SBE160, SBX175
172385-004-15	15 ft.	1/0	SB350	SBE160, SBX175
172385-004-20	20 ft.	1/0	SB350	SBE160, SBX175
172385-004-25	25 ft.	1/0	SB350	SBE160, SBX175
172385-002-08	8 ft.	1/0	SB350	SB350
172385-002-15	15 ft.	1/0	SB350	SB350
172385-002-20	20 ft.	1/0	SB350	SB350
172385-002-25	25 ft.	1/0	SB350	SB350
172385-005-08	8 ft.	1/0	SB175	SBE160, SBX175
172385-005-15	15 ft.	1/0	SB175	SBE160, SBX175
172385-005-20	20 ft.	1/0	SB175	SBE160, SBX175
172385-005-25	25 ft.	1/0	SB175	SBE160, SBX175
172490-001-08	8 ft.	2/0	SB350	SB350
172490-001-15	15 ft.	2/0	SB350	SB350
172490-001-20	20 ft.	2/0	SB350	SB350
172490-001-25	25 ft.	2/0	SB350	SB350
172490-002-08	8 ft.	2/0	SB350	SBE320, SBX350
172490-002-15	15 ft.	2/0	SB350	SBE320, SBX350
172490-002-20	20 ft.	2/0	SB350	SBE320, SBX350
172490-002-25	25 ft.	2/0	SB350	SBE320, SBX350
172490-003-08	8 ft.	2/0	SB350	DIN320
172490-003-15	15 ft.	2/0	SB350	DIN320
172490-003-20	20 ft.	2/0	SB350	DIN320
172490-003-25	25 ft.	2/0	SB350	DIN320
172490-004-08	8 ft.	2/0	SB175	DIN160
172490-004-15	15 ft.	2/0	SB175	DIN160
172490-004-20	20 ft.	2/0	SB175	DIN160
172490-004-25	25 ft.	2/0	SB175	DIN160
172490-006-08	8 ft.	2/0	SB175	SB175
172490-006-15	15 ft.	2/0	SB175	SB175
172490-006-20	20 ft.	2/0	SB175	SB175
172490-006-25	25 ft.	2/0	SB175	SB175
172490-007-08	8 ft.	2/0	SB175	SB350
172490-007-15	15 ft.	2/0	SB175	SB350
172490-007-20	20 ft.	2/0	SB175	SB350
172490-007-25	25 ft.	2/0	SB175	SB350
172490-008-08	8 ft.	2/0	SB175	SBE320, SBX350
172490-008-15	15 ft.	2/0	SB175	SBE320, SBX350
172490-008-20	20 ft.	2/0	SB175	SBE320, SBX350
172490-008-25	25 ft.	2/0	SB175	SBE320, SBX350
172490-010-08	8 ft.	2/0	SB175	DIN320
172490-010-15	15 ft.	2/0	SB175	DIN320
172490-010-20	20 ft.	2/0	SB175	DIN320
172490-010-25	25 ft.	2/0	SB175	DIN320
172498-001-08	8 ft.	3/0	SB350	SB350
172498-001-15	15 ft.	3/0	SB350	SB350
172498-001-20	20 ft.	3/0	SB350	SB350
172498-001-25	25 ft.	3/0	SB350	SB350
172498-003-08	8 ft.	3/0	SB350	SBE320, SBX350
172498-003-15	15 ft.	3/0	SB350	SBE320, SBX350
172498-003-20	20 ft.	3/0	SB350	SBE320, SBX350
172498-003-25	25 ft.	3/0	SB350	SBE320, SBX350
172498-002-08	8 ft.	3/0	SB350	DIN320
172498-002-15	15 ft.	3/0	SB350	DIN320
172498-002-20	20 ft.	3/0	SB350	DIN320
172498-002-25	25 ft.	3/0	SB350	DIN320
172499-001-08	8 ft.	4/0	SB350	SB350
172499-001-15	15 ft.	4/0	SB350	SB350
172499-001-20	20 ft.	4/0	SB350	SB350
172499-001-25	25 ft.	4/0	SB350	SB350
172499-003-08	8 ft.	4/0	SB350	SBE320, SBX350
172499-003-15	15 ft.	4/0	SB350	SBE320, SBX350
172499-003-20	20 ft.	4/0	SB350	SBE320, SBX350
172499-003-25	25 ft.	4/0	SB350	SBE320, SBX350
172499-002-08	8 ft.	4/0	SB350	DIN320
172499-002-15	15 ft.	4/0	SB350	DIN320
172499-002-20	20 ft.	4/0	SB350	DIN320
172499-002-25	25 ft.	4/0	SB350	DIN320

Connector Housing

Connectors	Description
078723-002	SB175 Connector Housing Gray
078723-004	SB175 Connector Housing Yellow
078723-007	SB175 Connector Housing Red
078723-008	SB175 Connector Housing Blue
078723-001	SB350 Connector Housing Gray
078723-003	SB350 Connector Housing Red
078723-006	SB350 Connector Housing Blue
078723-009	SB350 Connector Housing Yellow
078723-011	SB350 Connector Housing Green
078723-012	SB350 Connector Housing Black
108801-005	SBE160 Connector Housing Red
108801-011	SBE160 Connector Housing Gray
108801-012	SBE160 Connector Housing Blue
108801-001	SBE320 Connector Housing Gray
108801-002	SBE320 Connector Housing Green
108801-003	SBE320 Connector Housing Red
108801-006	SBE320 Connector Housing Blue
108801-008	SBE320 Connector Housing Yellow
108801-010	SBE320 Connector Housing Black
340028-001	SBX175 Connector Housing Gray
340028-002	SBX175 Connector Housing Blue
340028-004	SBX175 Connector Housing Yellow
340028-005	SBX175 Connector Housing Red
340090-001	SBX350 Connector Housing Gray
340090-002	SBX350 Connector Housing Blue
340090-003	SBX350 Connector Housing Black
H24985-502	SBX350 Connector Housing Red
340090-005	SBX350 Connector Housing Green
340090-007	SBX350 Connector Housing Yellow
341227-115	A160 Male Connector Housing
340320-112	A320 Male Connector Housing
340320-312	A320 Male Connector Housing
340320-412	A320 Male Connector Housing

*Connector housings need to be ordered separately.



Posters

Crown has released a number of new V-Force Energy Solutions posters to help promote products and best practices in Crown retail and dealer facilities and in customers' operations. All six can be ordered through the ODP Business Solutions website by each retail or dealer location's authorized user. After logging in, visit the Crown Branded Products section of the ODP site.

Promotional 24" x 36" Laminated Posters



Crown Part Number MGT20590
Office Depot VF1-PS38



Crown Part Number MGT20591
Office Depot VF3-PS39



Crown Part Number MGT20592
Office Depot VF3-PS40

Instructional 22" x 28" Laminated Posters

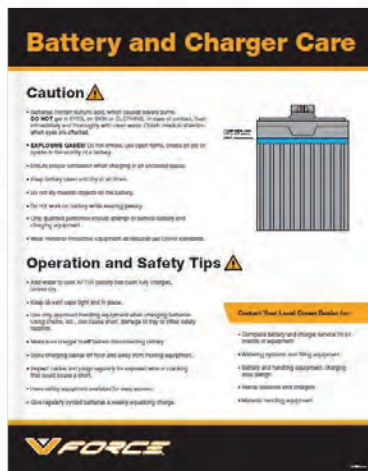

Crown Part Number PF18827
Office Depot PS22



Crown Part Number PF19474
Office Depot PS24



Crown Part Number PF20705
Office Depot PS41



V-Force® Lithium-Ion Energy Storage Systems

The V-Force® Lithium-Ion ESS is fully integrated with a full line of Crown lift trucks for flexibility, scalability and convenience.



- **Lower Maintenance, Lower Costs** – Eliminates the time-consuming tasks associated with lead-acid batteries including battery changes, watering or special battery rooms.
- **Improved Efficiency** – Achieve greater efficiency, higher sustained voltage properties as the battery discharges.
- **True Opportunity Charging** – Increase uptime with periodic opportunity charging, enabling one lithium-ion battery to achieve more run time in a 24-hour period.
- **No Battery Swapping** – One lithium-ion battery can handle one shift or multiple shifts with no need for extra batteries or the downtime required to change them.
- **Increased Safety** – Zero emissions during charging means no gassing and no exposure to harmful acids and vapors. A multi-level safety architecture provides complete protection during use.
- **Longer Life** – Lithium-ion batteries outperform lead-acid batteries, saving replacement and service costs over time.

Note: Communication/Diagnostic Kit (Part No. 165064) includes Communication Y cable and Peak Can Dongle. Communication/Diagnostic Cable Only (Part No. 165541-001)



V-Force Lithium Ion Energy Storage Systems for WP Series Pallet Truck

The V-Force Lithium Ion Pack's design supports superior functionality to promote easier, more efficient use



- Integrated on-board charger
- Fully integrated with truck display showing battery discharge levels and warnings
- Connection to the Early Warning System alerts the operator before the battery stops truck operation
- The battery management system extends battery life by preventing abuse and operation outside warranted conditions
- **Longer Life** - Can undergo considerably more charge/discharge cycles than lead acid batteries before their capacity is significantly reduced
- **Extended Run Time** - Higher energy density, often resulting in longer run time versus lead acid batteries
- **More Efficient** - More energy efficient when charging and discharging, reducing carbon footprint
- **Safer and Easier to Maintain** - Maintenance free, eliminating the need for battery watering and avoiding the exposure of your employees to harmful acid and vapors
- CE compliant and UL Listed
- Warranty - 5 years from date of sale, or when reaching Maximum Ah Throughput, which is 2000 cycles x 80% of the battery capacity

Note: Authorization of Modification is needed for trucks not already modified for lithium ion batteries by Crown Equipment.

Communication Accessory Kit (P.N. 164423-001): Includes: 24V Jumper Plug for deeply discharged recovery. Communication Peak Can Dongle, Communication Cable for downloading data and diagnostics, and Replacement Comms Cable.

Communication Accessory Kit Less Dongle (P.N. 164423)

Communication Cable Only (P.N. 164469-002)

24V Jumper Plug (P.N. 164424): For deeply discharged recovery.

Power Cable NEMA/CEE7 14AWG 2M BLK (P.N. 300805-042)

⚠ **WARNING:** Cancer and reproductive harm - www.P65Warnings.ca.gov



V-Force Lead Acid Batteries

With a lower initial cost than other battery technologies, V-Force lead acid batteries can provide a cost-effective power solution for a range of duty cycles, including multi-shift operations.



Flat Plate Lead-Acid Batteries

This traditional time-tested battery design for electric lift trucks features:

- Robust design for durability in rough applications
- More active material for greater performance and capacity
- Heavy grid construction to limit corrosion
- Exclusive five-layer wrap to minimize positive active material shedding
- Lower initial cost



Tubular Lead-Acid Batteries

This advanced lead-acid technology increases the surface area of active material, improving productivity and extending runtimes for multi-shift applications.

- Flexible bolt-on inter-cell cable connectors for easy maintenance, higher current delivery with less internal resistance and lower operating temperatures
- Fully insulated flex connectors and post bolts to prevent arcing and lead exposure
- V-LA1120 Series - Standard low maintenance cells that hold more water, reducing watering frequency and maintenance costs
- V-LA1130 Series - High capacity cells for increased run time for high duty cycle applications

⚠ WARNING: Cancer and reproductive harm - www.P65Warnings.ca.gov

V-Force Lithium Compact Batteries



Part Number	Description	Voltage	Rated Capacity	Approx. Weight	Truck Series
Wave Lithium Block Batteries					
165418-*	Battery Lithium 24V Block	24V	105AH	25 KG / 56 LB	WAVE
*Note: the dash number is equal to the language. Use these dash numbers for these languages: 001-0S United States, -002-0S Canada, -003-0S Mexico, -004-0S Austria, -005-0S Belgium, -006-0S Estonia, -007-0S France, -008-0S Germany, -009-0S Italy, -010-0S Netherlands, -011-0S Spain, -012-0S Portugal, -013-0S Romania, -014-0S United Kingdom, -015-0S Brazil, -016-0S Singapore, -017-0S Costa Rica, -018-0S Thailand, -019-0S New Zealand, -020-0S Australia					
WP Lithium Block Batteries					
849111-100-01-0	Compact Battery V1 Stand Alone	24V	105AH	26 ± 1.3 KG	WP

Deep Cycle Batteries

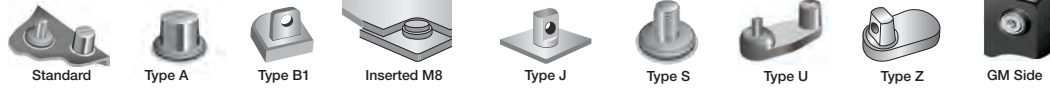

Part Number	Pallet Part Number	BCI Group	RC Min	20Hr Rate (AH)	Crown Applications	Terminal Style	Weight (lb)	LxWxH (in)**	Liquid Level Indicator
Flooded 6 Volt									
345006-095*		1	130 @ 25 A	130		Type A	31	9.08x6.91x8.75	No
071419-001		1	180 @ 75 A	100	M, B, ST3000	Type A	32	9.00x6.78x8.88	No
371419-002***		1	130 @ 75 A	100		Type A	34	9.03x6.86x8.69	No
345006-180		GC2	90 @ 75 A	180		Type S	55	10.25x7.13x10.75	No
072798-001		GC2	100 @ 75 A	190	M	Type A	59	10.25x7.12x10.62	No
345006-200-01		GC2	105 @ 75 A	200		Standard	60	10.25x7.13x10.75	No
345205	345205-030	GC2	389 @ 25 A	205		Standard	56	10.25x7.06x9.88	No
345225	345225-030	GC2	115 @ 75 A	225	GPW, WAVE	Standard	63	10.25x7.13x10.75	No
092222-002***		GC2	115 @ 75 A	225		Type S	63	10.75x7.13x10.75	No
345006-235	345006-235-30	GC2	125 @ 75 A	235		Standard	68	10.25x7.13x10.75	No
345006-240		Euro GC	125 @ 75 A	240		Type A	64	9.63x7.50x10.75	No
120194-001	120194-001-30	GC2H	145 @ 75 A	245	WAVE	Type S	73	10.25x7.13x11.5	No
345006-250		901	140 @ 75 A	250		Standard	72	11.75x7.19x11.25	No
345006-305		902	175 @ 75 A	305		Standard	92	12.19x7.19x14.13	Yes
345006-325		902	196 @ 75 A	325		Standard	100	12.19x7.19x14.13	Yes
345006-350		903	210 @ 75 A	350		Standard	112	12.38x7.19x16.13	Yes
345006-395		903	225 @ 75 A	395		Standard	120	12.38x7.19x16.13	Yes
345006-430		903	240 @ 75 A	430		Standard	122	12.38x7.19x16.13	Yes
Flooded 8 Volt									
345008-150		GC8	250 @ 25 A	150		Type S	60	10.31x7.06x9.72	No
345008-165		GC8	75 @ 75 A	165		Type S	64	10.31x7.13x10.75	No
Flooded 12 Volt									
345012-085		24	140 @ 25 A	95		Standard	50	10.88x6.75x9.38	No
345012-090		24	140 @ 25 A	85		Standard	39	10.19x6.81x9.50	No
345012-115		27	170 @ 25 A	115		Standard	58	12.63x6.75x9.38	Yes
345012-140		31	200 @ 25 A	130		Standard	66	13.00x6.75x9.38	Yes
345012-150		GC12	61 @ 75 A	150		Standard	81	12.92x7.06x9.70	No
345012-155		920	68 @ 75 A	155		Type A & S	87	13.63x6.75x12.25	No
345012-185		921	85 @ 75 A	185		Type S & Z	108	15.50x7.00x14.50	Yes
345012-210		921	110 @ 75 A	210		Standard	131	15.50x7.00x14.50	Yes
Sealed 6 Volt									
345006-200 (Gel)		GC2	105 @ 75 A	200		Standard	67	10.24x7.13x10.61	No
156131	156131-030	27	195 @ 25 A	220	WAVE, WP2000, WP2300, ST3000, SX3000	Inserted M6	64.9	12.09x6.61x8.39	No
345205-220 (AGM)		GC2	125 @ 75 A	220		Standard	70	10.24x7.13x10.61	No
Sealed 12 Volt									
345012-018-0S		N/A	10 @ 25 A	18		Type B1	11.61	7.13x3.03x6.57	No
345012-026-0S		N/A	14 @ 25 A	26		Type B1	17.14	6.50x6.93x5.00	No
345012-055-0S		22NF	60 @ 75 A	55		Type Z	37	9.00x5.43x8.19	No
345012-075		24	145 @ 25 A	75		Type Z	49	10.2x6.61x9.06	No
345012-075-01		24	140 @ 25 A	75		Insert M6	49	10.25x6.61x8.31	No
345012-100-0S		27	175 @ 25 A	100		Type Z	70	12.09x6.65x8.31	No
345012-110		31	210 @ 25 A	110		Standard	76	12.96x6.81x9.18	No
345012-100-0U		27	175 @ 25 A	100		Standard	60	12.09x6.65x8.31	No
345012-031-SS		31	175 @ 25 A	120		Standard	57	13.00x6.75x9.38	No
345012-035-0S		U1	N/A	35		Type Z	22.33	7.68x5.12x6.10	No
H51535-505		920	240 @ 25 A 85 @ 75 A	135	Floor Care Equipment	Standard	90	13.39x6.81x11.14	No

⚠ WARNING: Cancer and reproductive harm - www.P65Warnings.ca.gov

*Maintenance free **Height includes posts ***Moist/Dry Battery

Starter Batteries



Part Number	Pallet Part Number	BCI Group	RC-Reserve Capacity @ 25 Amps	CCA	Terminal Style	Weight (lb)	LxWxH (in)**
Flooded 12 Volt							
345004-100		4D-1000	300	1000	Type A	100	20.63x8.63x10.00
345004-130		4D-1300	375	1300	Type A	52	20.63x8.63x10.00
345005-850***		4DLT	255	850	Type A	87	20.44x8.13x8.00
345022	345022-060	22NF	65	400	Type A	27	9.50x5.56x9.00
168531		27	170	600	LPT	58.2	12.13x6.61x9.49
163397		24	90	800	Automotive	47	10.20x6.81x9.49
345024	345024-042	24	85	550	Type A	39	10.25x6.75x9.00
345024-675		24	90	675	Type A	39	10.25x6.75x9.00
345024-675-01	345024-675-42	24F*	105	675	Type A	42	10.25x6.75x9.00
345025-500		25	100	500	Type A	35	9.63x7.00x8.88
345026-500		26/26R	65	500	Reverse	29	8.25x6.81x8.25
345027-700		27	105	700	SAE / Type A	45	12.00x6.6.75x9.00
345027-710		27	120	710	Type A	45	12.00x6.75x9.00
345031-775-01		31	170	775	Type S	58	12.94x6.75x9.44
345031-1000		31	185	1000	Type S	61	12.94x6.75x9.44
345031-1000-MF		31S	170	1000	Type S	61	13.00x6.75x9.44
345010-960***		31A	180	960	Type A	61	13.00x6.75x9.44
345034-675		34	105	675	Type A	42	10.25x6.81x8.19
345035-540		35	90	540	Type A	37	9.13x6.75x8.63
345036-675-01		36R	120	650	SAE / Type A	42	10.25x7.25x7.88
347047-600		47	95	600	Type A	34	9.63x7.00x6.94
345007-730***		48/L3	105	730	Type A	40	11.00x6.88x7.50
345011-800***		49/93	165	800	Type A	48	13.94x6.88x7.50
345051-450-0R		51R*	80	450	Type A	28	9.38x5.00x8.75
345058-600		58	80	600	Type A	32	9.31x7.25x7.00
345058-600-0R		58R*	80	600	Type A	32	9.31x7.25x7.00
345009-590***		59	90	590	Type A	34	10.13x7.50x7.63
345070-450		70	65	450	GM Side	30	8.25x7.25x7.38
345075-690		75	90	690	GM Side	37	9.13x7.06x7.38
345078-800		78	105	800	GM Side	42	10.25x7.06x7.38
345008-147-50		8D	430	1475	Type A	132	20.63x10.94x10.00
345300-500		[JIS]B24L70	85	500	Automotive	28	9.05x5.08x8.78
065202****		51	93	510	Automotive	28	9.44x5.12x8.86
Sealed 12 Volt							
345024-080		24	140	500	Standard	51	11.26x6.75x8.12
345031-110		31	200	650	Standard	60	13.00x6.77x10.17

Note: See terminal types listed on page 8.18.

*Signifies reverse post. **Height includes posts. ***Includes handle. ****Maintenance free.

WARNING: Cancer and reproductive harm - www.P65Warnings.ca.gov

BATTERY AND CHARGER

Battery Display Rack

Part Number	Holds Number of Batteries
345000	6
345001	9



Retail Mobility Carts - Battery Replacement Guide

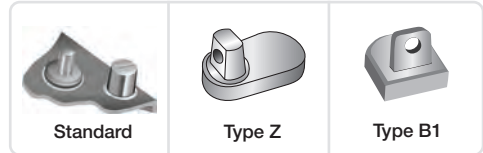

Make/Model	Quantity	Crown Part No.	Voltage	BCI Group	RC Min.	20Hr Rate (AH)	Terminal Style	Weight (lbs.)	LxWxH (in.)
Amigo - Smart Shopper	2	345012-035-0S	12V Sealed	U1	N/A	35	Type Z	23.33	7.68x5.12x6.10
Amigo - Value Shopper	2								
Amigo - Value Shopper XL	2								
Invacare - Lynx 3 Wheel	1 or 2								
Invacare - Lynx 4 Wheel	1 or 2								
Invacare - Lynx L-3X	1 or 2								
Invacare - Leo 3 Wheel	2								
Invacare - Leo 4 Wheel	2								
MartCart - 3563	1 or 2								
MartCart - 3500	1 or 2								
MartCart - 3524	1 or 2								
Shoprider Scooters - Sunrunner	2								
Dane Technologies - SmartKART	2								
Amigo - Value Shopper 34	2	345012-018-0S	12V Sealed	12V-18 Ah	10 @ 25A	18	Type B1	11.61	7.13x3.03x6.57
Pride Mobility - Go-Go Elite Plus	2								
Dane Technologies - QuickKART	3	345012-085	12V Flooded	24	160 @ 25A	85	Standard	50	11.13x6.75x9.38
Dane Technologies - QuickKART	3	345031-730	12V Sealed	31	190 @ 25A		¾x 16 Post	62.5	13x6.75x9.5

WARNING: Cancer and reproductive harm - www.P65Warnings.ca.gov

Starter & Deep Cycle Battery Supplier Cross Reference

Continued ▶



Starter Battery Supplier Cross Reference

BCI Group Size No.	Crown Equipment	Crown Battery	Interstate Battery	East Penn Mfg Co	Exide Tech	NAPA Batteries
North American BCI Group Sizes - 12 Volt Automotive						
24	345024-675	24-675	---	624MF	24-72	7524
	345024	24-550	I-24	524MF	24-60	6024
24F	345024-675-01	24F-675	I-24F	624FMF	24F-72	6024F
25	345025-500	25-500	MT-25	525MF	25-72	5025
26	345026-500	26-500	MT-26	526	26-60	6026
27	345027-800	27-800	MTP-27	727MF	27-60	8427 / 7527
	345027-710	27-710	---	627MF	---	---
34	345034-675	34-675	MT-34	634MF	34-72	8434
35	345035-540	35-540	MT-35	535MF	35-72	5035
36R	345036-675-01	36R-650	MTP-36R	636RMF	36R-72	7536R
45	65202	45-500	I-45	545MF	45-495	7545 / 5045
51R	345051-450-OR	51R-500	MT-51R	551RMF	51R-450	5051R
55	345055-525	55-525	MT-56	555MF	56-535	8456 / 7556
58	345058-600	58-550	MT-58	658MF	58-540	8458 / 6058
58R	345058-600-OR	58R-550	MT-58R	658RMF	58R-580	7558R
75	345075-690	75-690	MTP-75	675MF	75-630	8475
78	345078-800	78-800	MTP-78	778MF	78-770	8478
North American BCI Group Sizes - 12 Volt Automotive Dual Terminal						
34/78	345034-800	34/78-800	I-78DT	678DT	78DT-650	8434/78
North American BCI Group Sizes - 6, 8 & 12 Volt Commercial Starting						
31	345031-1000A	31A-SD1000	31-MHD P	1131XMF	XHP-31E	7235 / 7237
	345031-1000	31S-SD1000	31-MHD S	1131XMF(S)	XHP-31D	7234 / 7236
	345031-775	31A-SD775	31-LHD P	1131PMF	31E-925	7239
	345031-775-01	31S-SD775	31-LHD S	1131PMF(S)	31D-925	7238
4D	345004-130	4D-1300	--	--	--	--
8D	345008-147-50	8D-1475	8D-MHD	908D	8D-1300	7271 / 8276
1	345006-095	1-640	1-VHD	901MF	1-625	7244
4H	345004-950	4H-950	4-XHD	904MF	4-975	7210 / 7212
3EE	345003-400-EE	3EE-400	3EE-VHD	403E	3EE-370	7250
22NF	345022	22NF-400	SP-22NF	322NF	22NF-390	5022NF

WARNING: Cancer and reproductive harm - www.P65Warnings.ca.gov

Starter & Deep Cycle Battery Supplier Cross Reference



Starter Battery Supplier Cross Reference

BCI Group Size No.	Crown Equipment	Crown Battery	Interstate Battery	East Penn Mfg Co	Exide Tech	NAPA Batteries
Severe Duty Commercial Maintenance-Free Batteries						
24	345012-090	24SDC	---	---	---	---
51	065202	51SDC	---	---	---	---
31	345012-031-SS	31DTSDC	---	DP31CS	---	---
European / Asian BCI Group Sizes - 12 Volt Automotive						
47/90	347047-600	47-600	MT-47	647MF	47-600	8447 / 7547

⚠ **WARNING:** Cancer and reproductive harm - www.P65Warnings.ca.gov



Deep Cycle Battery Supplier Cross Reference

BCI Group Size No.	Crown Equipment	Crown Battery	Interstate Battery	East Penn Mfg Co.	Trojan Battery	US Battery
North American BCI Group Sizes - 6, 8 & 12 Volt Deep Cycle						
GC2	345006-180	CR-180	---	---	---	---
	345205	CR-205	GC2-HCL-UT	---	Pacer	US-1800
	345006-200-01	CR-220	GC2-ECL-UTL	GC-10	T-605	US-2000
	345225	CR-225	2300UT	GC-15	T-105	US-2200
	345006-235	CR-240	2400UT	GC-25	T-125	US-125
Euro GC	345006-240	CR-240E	---	---	TE35	---
GC2H	120194-001	CR-260	---	GC-45	T-145	US-145
901	345006-250	CR-250	U2500	8C11	J250G	US-250
902	345006-305	CR-305	U3050	---	J305E	US-305
	345006-325	CR-325	---	8C6V	J305PG	US-305HC
903	345006-350	CR-350	UL16	---	L16E	L16E
	345006-395	CR-395	---	8L16	L16G	L16
GC8	345008-165	CR-165	U8VGC	GC8V	T-875	8VGC
24	345012-085	24DC95	SRM-24	DC-24	24TMX	24DC
27	345012-115	27DC115	SRM-27	DC27	27TMH	27DC
31	345012-140	31DC130	SRM-29	DC31DT	30XHS	31DC
GC12	345012-150	CR-GC150	---	GC12V	T1275	GC12
920	345012-155	CR-155	---	---	J150	EV-145
921	345012-185	CR-185	U1850	8C12	J185G	US-185E
	345012-210	CR-210	---	9C12	J185P	US-185

⚠ **WARNING:** Cancer and reproductive harm - www.P65Warnings.ca.gov



VRLA Battery Supplier Cross Reference

BCI Profile	Crown Equipment	Crown Battery	Discover Battery	East Penn Mfg	Fullriver Battery	Interstate Battery	Trojan Battery	US Battery
6 Volt AGM Batteries								
GC2	345205-220	6CRV220	EVGC6A-A	8AGC2	DC224-6A	GC2-HD-AGM	T105-AGM	US AGM 2224
6V-27	356131	6CRV215	EV627A-A	---	DC200-6	---	---	US AGM 6V27
12 Volt AGM Batteries								
18 Ah	345012-018-0S	12CE18 (B1)	D12180-80W	ES20-12C	DC20-12	SLA1116	---	---
26 Ah	345012-026-0S	12CE26 (B1)	EV512A-24	ES26-12	DC26-12B	SLA1143	---	---
U1L	345012-035-0S	12CE35	EVU1A-A	8AU1	DC35-12B	SLA1155	---	---
22NF	345012-055-0S	12CE55	EV22A-A	8A22NF	DC55-12	SLA1165	---	---
24	345012-075-01	12CE75 (I)	EV24A-A	8A24	DC85-12	SLA1175	24-AGM	---
	345012-075	12CE75 (J)					---	---
27	345012-100-0S	12CE100 (J)	---	8A27	DC105-12	SLA1185	27-AGM	US AGM 27
	345012-100-SS	12CE100 (M)	EV27A-A	827M	---		---	---
	345012-100-OU	12CE100 (U)	EV27A-A	---	---		---	---

⚠ **WARNING:** Cancer and reproductive harm - www.P65Warnings.ca.gov

Rescue Jump Packs

Lead Acid Battery Rescue Jump Packs

Crown Part Number	Description	Peak Amps	Volt	Cable Length	Gauge	DC Power Source	Air Compressor/ Air Gauge	LED Battery Status Gauge	Built-In Work Light & Flasher	Illuminated LED Clamps	Other Specs
300455-090	Rescue Jump Pack Model 900	1000	12	27"	6	●					Premium 18 amp hour AGM battery, LED battery charging status, built-in charger.
300455-095	Rescue Jump Pack Model 950	1000	12	55"	6	●	●	●	●	●	18 amp hour AGM battery, Multiple air tips, polarity alarm, built-in charger, LED battery charging status.
300455-180	Rescue Jump Pack Model 1800	4000	12	62"	2	●		●	●		2 heavy duty 20 amp hour AGM batteries, safeguard audible signal and light, polarity alarm, internal battery gauge.
300455-210	Rescue Jump Pack Model 2100	4000-12v 1800-24v	12-24	62"	2	●			●		12/24V power, dual 12v 20AH high output, AGM batteries, built-in CEC compliant 1 amp internal charger, digital battery voltage gauge reads internal and external, 12v power outlet, battery charging status, USB power outlet.

⚠️ **WARNING:** Cancer and reproductive harm - www.P65Warnings.ca.gov



300455-090



300455-180



300455-210



300455-095

IC Planned Maintenance and Tune-Up Kits

Available for IC forklifts and engine types from a wide variety of manufacturers.



Planned Maintenance Kits Include:

- Air Filter
- Oil Filter
- 10W30 Motor Oil

Tune-Up Kits Include:

- Distributor Cap
- Rotor
- Spark Plugs
- Ignition Wire Set



See IC Truck Components Section

one source
LIFT TRUCK PARTS



Forklift Laser Guidance Systems

Reduce Damage and Increase Productivity

See Work Assist Section

Battery Watering Application Chart

Use the following table to help determine the best system for the application at hand. Not all applications are alike; be sure to put the appropriate product into the correct application to ensure years of cost effective & reliable operation.

Product	Watering Gun	Float System	Injector System
Facility Size	1-5 batteries	5-25 batteries	25 or more batteries
Application	Light Duty Small Facility Infrequent Use Golf Course	Medium Duty Low Water Pressure Medium Facility	Heavy Duty Abusive Conditions Rapid Charge Battery Changers
Time to Install	Not Applicable	12 Minutes	3 Minutes
Time to Fill an 18-Cell Battery	20 Minutes	2-10 Minutes	15 Seconds
Payback/ROI	\$	\$\$	\$\$\$

V-Force® Barbed Watering Float System Kits



V-Force Barbed Valve Battery Watering Float Systems make the watering of your industrial batteries faster and safer. You will need two components: a water supply (found throughout the One Source Catalog) and one of the part numbers found below. If you have a Philadelphia Scientific Water Supply, you can order a V-Force Float System (e.g. 300316-012-INJ) to replace your existing Stealth Kit or an Injector Kit.

The process is simple. First, identify the manufacturer of your water supply (e.g. Philadelphia Scientific, Battery Filling Systems (BFS), Battery Watering Technologies (BWT), V-Force, or Flow Rite). Then, identify the battery manufacturer; Douglas batteries will require a DIN adapter, which is included. Next, determine the battery voltage (24V, 36V, 48V). The final step is to select the watering system from the table below. The adapters shown are included so you can connect the kit you choose to your water supply.

Voltage	CPC 3/4" input Brands used with Crown V-Force (most common), Philadelphia Scientific Stealth and Flow-Rite. Select a system below.	CPC 1/2" input (used primarily with BWT (Battery Watering Technologies). Select a system below.	BFS input (used primarily with BFS (Battery Watering Technologies). Select a system below.	Quick Connect Input Brands used with are Philadelphia Scientific Water Injector and Water Injector Spider. Select a system below.
12V	300316-006	300316-006-BWT	300316-006-BFS	300316-006-INJ
24V	300316-012	300316-012-BWT	300316-012-BFS	300316-012-INJ
36V	300316-018	300316-018-BWT	300316-018-BFS	300316-018-INJ
48V	300316-024	300316-024-BWT	300316-024-BFS	300316-024-INJ
72V	300316-036	300316-036-BWT	300316-036-BFS	300316-036-INJ
80V	300316-040	300316-040-BWT	300316-040-BFS	300316-040-INJ

Douglas Batteries (DIN vent openings): 24V-300316-012-01, 36V-300316-018-01, 48V-300316-024-01, 80V-300316-040-01

NOTE: Tubing cutter P.N. 3003227-allation tool and P.N. 300310-022 are helpful for installation of V-Force Float Watering Systems.

NOTE: V-Force watering kits installed from the factory on V-Force lead-acid batteries (Part# ending with -INS or -INP) use the same components as the kits above.

V-Force Barbed Watering Float Valve & System Components

V-Force
Barbed Valve Option

300316-007

Highly Visible Fill Level Indicator
Viewable from top and side

Barbed Fittings
Clampless Barbed Fittings make it easy to secure tubing

Snap-Fit Base
No separate adapter required

Rotatable Base
Once installed

Built-in Float Guard

Lowest Profile
0.60" (15.2 mm)

5-YEAR WARRANTY

"One Size Fits All"

- Fills all cells to appropriate level
- Multiple float sizes not needed

V-Force Battery Watering System Components

Barbed Watering Kit Components	
Component Part Number	Component Description
300316-007	V-Force Barbed Valve
300316-002-XX	V-Force Barbed Tubing
300316-001	End Plugs For V-Force Barbed Watering
300316-004	Std Barbed Input Assembly V-Force

Standard Watering Kit Components	
Component Part Number	Component Description
300225-001	V-Force Float Assembly
300220-072-XX	V-Force Universal Tubing
300220-029	End Plugs for V-Force Watering
300220-083	Input Assembly V-Force

Additional Watering Kit Components	
Component Part Number	Component Description
300227-015	BFS Adapter
300227-031	BWT Adapter
300227-014	Flow-Rite Adapter
300310-008	Injector Tubing - 1/2" OD, 25'
300310-018	Injector Tubing - 1/2" OD, 500'



120 AC Mobile 10-Gallon Watering Cart

Part Number Vendor Number

300224-147 CRT-147

- This sturdy high-density polyethylene tank is designed to work with the V-Force Watering System™ to easily transport water to your batteries
- AC powered; handles like a hand truck.
- Easy to use! Simply connect to the V-Force Watering System™ and turn on the switch. The flow indicator will tell you when all the Stealth valves have shut off and its time to disconnect.
- Additional connectors & adaptors may be required (see Optional Equipment box below).



12 VDC Mobile 10-Gallon Watering Cart

Part Number Vendor Number

300224-090 FLT-090

- This sturdy high-density polyethylene tank is designed to work with the V-Force Watering System™ to easily transport water to your batteries.
- DC powered; handles like a hand truck.
- 12 volt sealed battery can be charged from any AC outlet.
- Easy to use! Simply connect to the V-Force Watering System™ and turn on the switch. The flow indicator will tell you when all the Stealth valves have shut off and its time to disconnect.
- Additional connectors & adaptors may be required (see Optional Equipment box below).

▲ Note: The V-Force Carts, Direct Link and Gravity Tank cannot be used with the Water Injector System™.

The use of deionized water is recommended for all tanks.

Optional Equipment

Standard Connector



Male CPC fitting to Female CPC Fitting

Adapters



300224-014 Front End & Flow Indicator for BFS style input coupling

300224-013 Front End & Flow Indicator for BWT-small CPC style input coupling

300223-002 Wall mountable shelf to hold the Gravity Tank

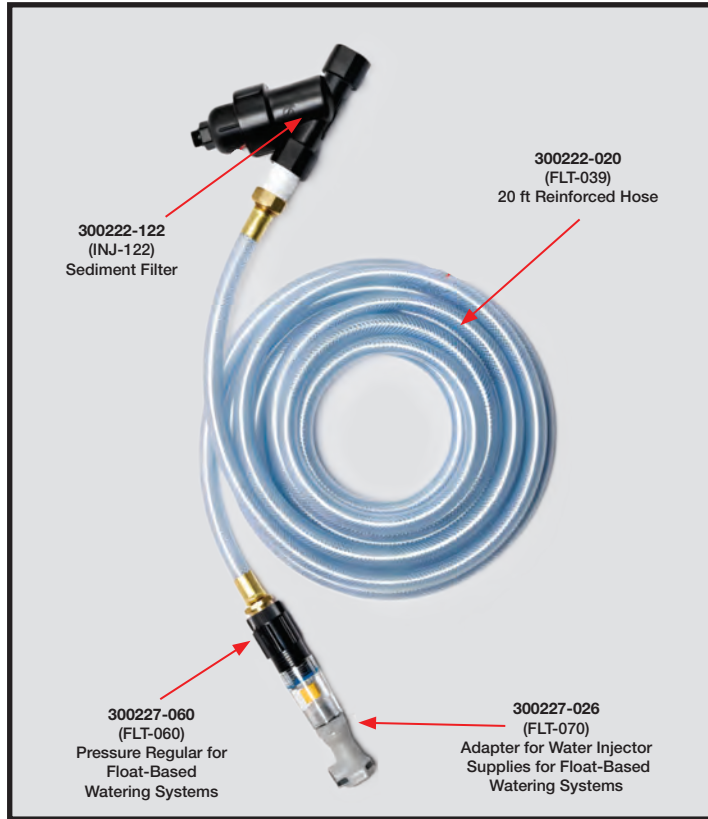

Direct Link Water Supply

Part Number	Vendor Number
300222	FLT-DL

- Designed to be used with the Stealth Watering System™ and the existing plumbing in your facility.
- Simply connect the Direct Link to the I wall tap, connect to the Stealth Watering System™, wait for the spinner to stop and disconnect.
- Simple and affordable!
- Additional connectors & adaptors may be required (see Optional Equipment box below).

▲ **Note:** The V-Force Carts, Direct Link and Gravity Tank cannot be used with the Water Injector System™.

The use of deionized water is recommended for all tanks.



5-Gallon Gravity Flow Tank Hose

Part Number	Vendor Number
300223	FLT-GT

- Sturdy 5-gallon tank uses gravity to create enough water pressure to operate the V-Force Watering System™.
- Easy to fill from your water source.
- Features a flow indicator and 25' hose that attaches to the V-Force Watering System™ with a rugged female CPC® connector.
- Additional connectors & adaptors may be required (see Optional Equipment box below).

Note: Unit needs to be mounted at least 5 feet above the top of the battery.

Optional Equipment

Standard Connector

Male CPC fitting to Female CPC Fitting

Adapters

300224-014 Front End & Flow Indicator for BFS style input coupling	300224-013 Front End & Flow Indicator for BWT-small CPC style input coupling	300223-002 Wall mountable shelf to hold the Gravity Tank

Float System - Fill Options



V-Force Demo Watering Kit

Part Number	Vendor Number
300220-KIT	FLT-DD2V

- Portable unit designed to demonstrate the V-Force watering system
- Kit Includes: V-Force Watering Demo Unit w/AC power cord and carrying case



Shelf For Float System Gravity Tank

Part Number	Vendor Number
300223-002	FLT-018

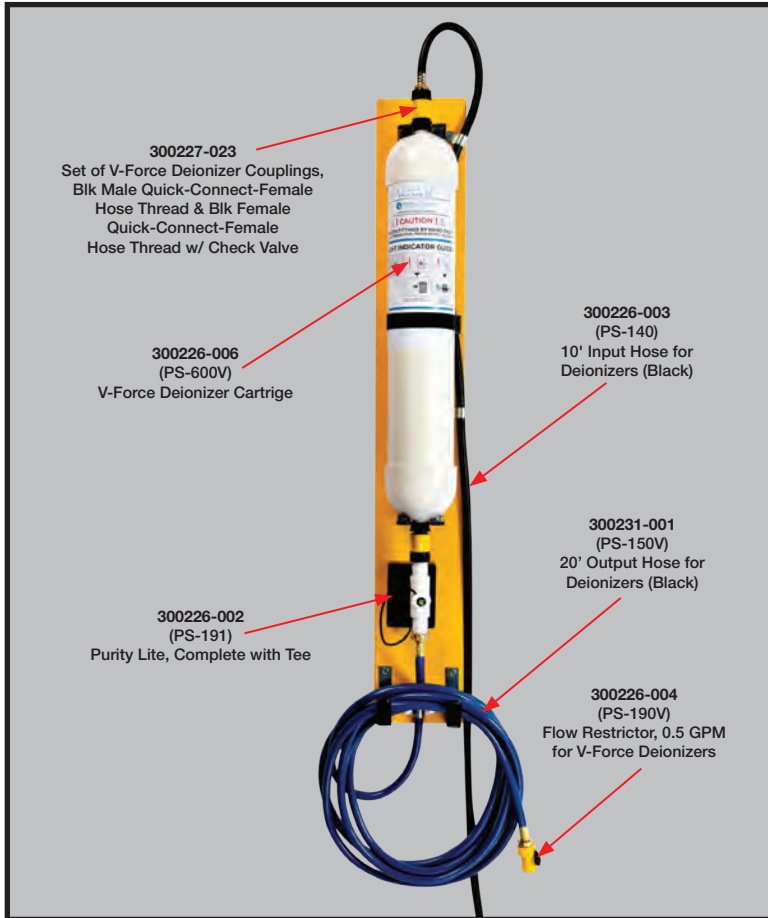

V-Force Deionizer

Part Number	Vendor Number
300226-005	PS-300

- Reduces the high price of buying bottled water, distilling water or using reverse osmosis.
- System pays for itself through increased battery life and less frequent battery purchases.
- Easy disposable Deionizer cartridge purifies about 600 gallons of water based on average water quality.
- System's purity light tells you exactly when cartridge is used up.
- Pressurized -- can be used directly with our battery watering guns and to fill up our water tanks and carts.
- Also compatible for us with the Stealth Watering System.
- Additional connectors & adaptors may be required (see Optional Equipment box below).

⚠ WARNING: Cancer - www.P65Warnings.ca.gov

Optional Equipment

Standard Connector



Attaches directly to a V-Force Watering Gun or use the Flow Restrictor to fill all tanks.

Adapters



300227-026
Stealth Adapter for Water Injector Supplies



300227-70A BFS
Adapter for Water Injector Supplies



300227-70E BWT
Adapter for Water Injector Supplies



300226-009112V
V-Force TDS Meter

Water Quality Tester

Part Number - 300226-009



Check the water quality in total Parts Per Million of Total Dissolved Solids in a facility's water supply. Scan a QR Code to get a battery water quality report emailed to you showing if the water requires a deionizer and how many gallons a cartridge should filter.

⚠ WARNING: Cancer - www.P65Warnings.ca.gov

Watering Gun

V-Force® Battery Watering Gun

Part No.	Vendor No.	Description
300236	GUN-XV	Works in 5/8" and 7/8" nozzle applications. Replaces GUN-B, GUN-FB, GUN-C, GUN-FC, GUN-G, GUN-FG, GUN-K, GUN-FK, GUN-R, GUN-R24, GUN-X.

Note: Replacement nozzle not available; order gun.

⚠ WARNING: Cancer - www.P65Warnings.ca.gov

Ergonomically Designed

- Easy-squeeze, rugged handle
- 45° bend nozzle
- Less bending over to fill battery

Superior Strength

- Built from rugged, engineered ABS plastic
- Weak points eliminated; pressure regulator incorporated into nozzle

Flow Diffuser

- Converts the rapid flow to a gentle spray
- Protects nozzle from damage

Secure Level Control

- Will not move over time
- Adjustable or removable
- Pre-set for optimum level for most motive power batteries
- Beveled to conform to vent well at many angles

Faster Fill

- 1.7 GPM
- Spend less time watering



Output Hose with Quick-Connect

Part Number

300234-002

- 10 ft. (3 m) of industrial output hose with quick-connect (CRT-120)

Casters



Available in 4 sizes:

- Phenolic, High Capacity Wheels
- Swivel or Rigid Options
- Durable
- Provides Floor Protection









See the Wheels and Tires Section

CROWN

Manufactured Forks with recessed fork tip indicators







Part No.	Vendor No.	Description	Part No.	Vendor No.	Description	
	300220-029	FLT-029	End Plug, Float Systems	300227-003	FLT-004U	Universal Float Input Assembly with Filter, BFS, BWT, Flow Rite, Stealth <i>Includes 300227-005 (Tee for Float System), 300227-010 (Assembled Filter), 300310-008 (Injector Tubing 7.62 m [25 ft], 12.7 mm [0.5 in] OD), and 300227-015 (Input Male Coupling); 300227-014 (Twist-Lock Male Input Coupling), 300227-031 (Male Coupling – BFS system – Blue Connector).</i>
	300220-032	BA-C20-21-6P	Valve ³ w/Adapter Millennium	300227-006	FLT-072	1/4" Tubing, 25 ft, Float System
	300220-083	FLT-083	Float Input Assembly w/Filter <i>Includes 300227-005 (Tee for Float System), 300227-020 (Assembled Filter), 300310-008 (Injector Tubing 7.62 m [25 ft], 12.7 mm [0.5 in] OD), and 300227-014 (Twist-Lock Male Input Coupling).</i>	300227-010	FLT-079	Replacement Input Filter Tee
	300220-089	FLT-089	Input Assembly for V-Force Watering System w/BFS/BWT Input Coupling & 2 End Plugs	300227-011	FLT-035	Float Valve, Coupling, Female
	300224-011	CRT-040	Pump, 12VDC, with clamps and elbows <i>1.8 gpm and output pressure of 60 psi.</i>	300227-014	FLT-087	Twist-Lock Male Input Coupling
	300224-149	CRT-149	Charger, 120VAC to 12VDC	300227-015	FLT-080	Coupling Male Input BFS Converter <i>Use with BFS - Black CPC Connector; order if you already have BFS Fill Guns or Links; connects with 1/2" tubing input end of V-Force Watering Kit.</i>
	300225-001	FLT-082	Float Assembly - Orange, V-Force	300227-016	FLT-085	DIN Vent Adapter for Douglas Battery
	300225-003	FLT-091	V-Force Slim Valve	300227-021	FLT-071	Direct Link Front End with Large BFS
	300227-001	FLT-L1	Float Assembly - Black	300227-026	FLT-070	Direct Link Front End Only; use with Injector or Deionizer Systems <i>Use with Flow Rite.</i>

Part No.	Vendor No.	Description
	300227-030 09FBLU1	Female Coupling
	300227-031 FLT-081	Male BWT Input Coupling, 3/8"
	300227-037 09MBLU1	BWT 1/4" Male Coupler <i>Mates with BWT 300227-047.</i>
	300227-038 09FWM1	Spinner/Flow Indicator
	300227-039 BA-032	Back Flow Preventer
	300227-040 BA-031	Hose BIBB Pressure Reducer
	300227-041 09FBLUT3	BWT Threaded Female Connector
	300227-042 ACC-108	Gripper Replacement - V-Force Watering System (50/pack)
	300227-047 BWT-09FBLU6	BWT 1/4" Female Coupler <i>Mates with BWT 300227-037.</i>

Part No.	Vendor No.	Description
	300227-060 FLT-060	Low Pressure Regulator
	300227-70A FLT-070A	Direct Link Front End with Large BFS
	300227-70E FLT-070E	Direct Link Front End with Small BFS
	300227-072 09FRTL2	Replacement Front End - BWT
	300227-073 DF72F	Direct Link w/Conn 9FUM1/9FRTL2F
	300227-074 DF72	Direct Fill Link DF72
	300227-075 L70654	Female Quick Connect For DF72
	300227-076 L70655	Quick Connect Male Adapter
	300227-077 PRG915	10 PSI Pressure Regulator

Float System Supplies and Parts

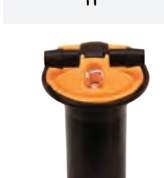
Part No.	Vendor No.	Description
	300227-078	GHAN2 Handle for Direct Fill Link
	300227-079	09FWM72A Flow Indicator
	300227-080	DF72G BWT - Direct Fill Link, Gray Standard
	300233 ⚠	ACC-066 Repair Kit for 300224-090. Black back panel includes on/off switch, charger jack, and 6 mounting screws. Does not include wiring.
	300310-005	INJ-694 Coupling Quick Connect
	300310-008	INJ-198 Injector Tubing 25 feet, 1/2" OD
	300310-018	INJ-495 Tubing Type 2, 375 feet, 1/2" OD
	300310-038	INJ-645 Inline Regulator Assembly
	300316-001	FLT-111 End Cap V-Force Barbed Watering System

Part No.	Vendor No.	Description
	300316-002	FLT-108 V-Force Universal Tubing Barbed
	300227-007	FLT-093 Tubing Cutter
	300316-003	FLT-112 Input Assembly V-Force - Barbed Injector
	300316-004	FLT-110 Standard Barbed input Assembly V-Force
	300316-005	FLT-115 Input Assembly V-Force - Barbed BFS
	300316-007	FLT-BL1V V-Force Barbed Valve
	300316-014	FLT-116 Input Assembly V-Force-Barbed BWT
	300316-016	FLT-119 Quart-Turn Vent Adapter, Stealth, Loose
	300317	BWT-09GRM6 BWT Grey Male Connector

⚠ WARNING: Cancer - www.P65Warnings.ca.gov

Float System - Kits & Parts

Flow Rite - Float Kits

Millennium Evo — Single-Point Watering System

- Valves work independently of water pressure, allowing a variety of water supply options
- 5-year warranty
- 3-port swivel tee rotates 360° for easier installation
- Flip top color matches shroud color for easy valve identification
- Built-in optical level indicator provides a quick and easy way to see when individual cells require water
- Raised vents provide more room inside the cell for fluid expansion
- Gasket retention tabs keep the gasket in place for simplified installation
- Protective shroud prevents damage to the displacer

Part No.	Vendor No.	Description
300220-024-01	BK-1CO-201-512	24V Universal Watering System
300220-036	BK-1CO-201-518	36V Universal Watering System
300220-048	BK-1CO-201-524	48V Universal Watering System
300220-080	BK-1CO-201-540	80V Universal Watering System
300220-024-100*	BK-1Y0-200-512	24V Universal Watering System
300220-036-100*	BK-1Y0-200-518	36V Universal Watering System
300220-048-100*	BK-1Y0-200-524	48V Universal Watering System
300220-080-100*	BK-1Y0-200-540	80V Universal Watering System
300220-032	BD-00870	Millennium Evo DIN Adapter

*Comes with internal and external spark arrestors with standard length design

Note: Spark Arrestor design does not fit Crown Max Haul 110MX or 155MX or GNB batteries



Flow Rite - Float Kits

Pro Fill — On-Board Battery Watering System

- Valves work independently of water pressure, allowing a variety of water supply options
- 5-year warranty
- 3-port swivel tee rotates 360° for easier installation
- Patented manifold allows for easier installation
- Winged caps provide fast and secure connection to the battery
- Built-in flame arrestor is a safety feature required for applications where batteries are charged inside the vehicle
- Acid, temperature and impact resistant components
- Protective shroud prevents damage to the displacer

Part No.	Vendor No.	Description
300220-001	BG-U24V-1G	24V Pro-Fill Universal Float Kit w/2.7" spacing
300220-002	BG-U24V-2G	24V Pro-Fill Universal Float Kit w/3.3" spacing
300220-006	BG-U24V-4G	24V Pro-Fill Universal Float Kit w/non standard spacing
300223-024	BG-U24V-BG	24V Kit For 8V 2.3"-2.5" Cell Spacing
300220-021	BG-U36V-1G	36V Kit For 6-6V w/2.7" Space
300220-025	BG-U48V-1G	48V Kit For (8) 6V Batteries w/2.7" Spacing
300223-048	BG-U48V-BG	48V Kit For 8V 2.3"-2.5" Cell Spacing

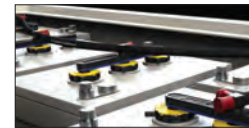

Float System - Fill Options

Part No.	Vendor No.	Description
300220-110	BA-MS-115	20 Gal AC/DC Watering Cart



Float System Parts

Millennium Evo and Pro-Fill

Part No.	Vendor No.	Description
300220-003	BA-Y7A-10	Valve/Float Replacement. Includes Swivel Tee w/O-Ring (300220-016)
300220-004	BD-TI4	Tubing Replacement - 1 ft.
300220-008	BA0QDV-805	Coupler for Philly Injector
300220-009	BA-QDV-505	Coupler 1/4" Standard fits Millennium Evo, Pro-Fill & Stealth
300220-015	BD-00280	Red End Cap for Swivel Tee
300220-016	BA-142	Swivel Tee w/O-Ring
300220-022	BA-QDV-500	Quick Coupler
300243-006	FR-BA-C10-21-6P	Black Flip Top Valve 6/Pack
300244-006	FR-BA-C10-31-6P	2.5 Flip Top Valve 6/Pack
300220-030	BA-T04	5' Millennium Evo Braided Hose



300220-003



300220-004



300220-008



300220-009



300220-015



300220-016



300220-022



300220-030

Water Supply - Parts

Part No.	Vendor No.	Description
300220-005	BA-MS-320-20	Regulated Hose Supply with 20' Hose
300220-010	BA-QDV-231	Female Coupler
300220-011	BA-FLW-80	Flow Indicator (Current) 1/4" NPT x Female Coupler
300220-013	BA-FLW-60	Flow Indicator (Current) 1/4" NPT x 3/8" FNPT
300220-017-01	BA-MS-320-00	Millennium Hose End Assembly
300220-019	BA-019	Inline Strainer for .5" ID
300220-020	BA-003	Regulator for Supply Hose
300220-026	BA-051	Purger for Supply Hose
300220-110-01	BD-00304	Watering Cart Rear Wheel
300220-110-02	BA-MS-110	Replacement Watering Cart 20 Gal AC/DC Charge Cord



300220-005



300220-017-01



300220-010



300220-011



300220-013



300220-110-01



300220-019



300220-020



300220-026

Spider Injector System – Kits



Spider Injector System

Part Number	Vendor Number	Description
300302-012	INJ-LP12	24V Spider Injector Kit Standard
300302-018	INJ-LP18	36V Spider Injector Kit Standard
300302-024	INJ-LP24	48V Spider Injector Kit Standard
300309-012	INJ-LP12D	24V Spider Injector Kit w/DIN adapter*
300309-018	INJ-LP18D	36V Spider Injector Kit w/DIN adapter*
300309-024	INJ-LP24D	48V Spider Injector Kit w/DIN adapter*

* Use on Douglas Batteries

Note: Tubing cutter 300227-007 and collar installation tool #300310-022 are required for installation of the spider injector watering system.

Note: Prestrung options available upon request.

ATTENTION: Spider Injector Watering Systems require a minimum of 25 psi and maximum of 35 psi flowing water at a rate of 8 gallons per minute. If the flow is inadequate, the Injectors will not shut off. If a factory authorized water supply is not being used water pressure from the wall must be confirmed with a 300310-027 Water Flow Pressure Measurement Tool.



Features

- **Very Fast Operation:** An average industrial truck battery can be filled, with precise level control, in less than 15 seconds. The savings in labor costs alone often pays for the system within its first year of operation.
- **Quality of Watering:** It extends the life of each expensive battery it is installed on due to improved quality of watering. The battery is properly watered every time.
- **Safety and Environmental Cleanliness:** There is no need to peer into cells to inspect levels as with manual filling. Spider Injector Watering Systems automatically fill each cell to the correct level, so no overfilling and no electrolyte overflow during charge.
- **Compact:** A very low profile allows them to fit on almost any battery. Spider Injectors can **snap in and out** to allow inspection of electrolyte levels and specific gravities.
- **Rugged:** Tough enough to survive impacts, abuse and extremes of battery temperatures. There are no exposed parts to break off even when a Spider Injector is removed from a cell. True level sensing mechanism. Needs no submergence to sense level as a float does. Can work right down to the top of the separators. Will not fail if it touches cell components.
- **No-Freeze Tubing:** The surplus water drains from the tubing into cells after filling is complete. This allows the system to be used in cold stores and other freezing environments.
- **2-Stage Filtration:** In addition to the filter screen in the water tubing, each Spider Injector has its own individual filter.
- **Easy Installation:** Features flexible push tubing.
- **5-Year Warranty:** Warrantable against defects in materials and workmanship.

Spider Injector Watering System

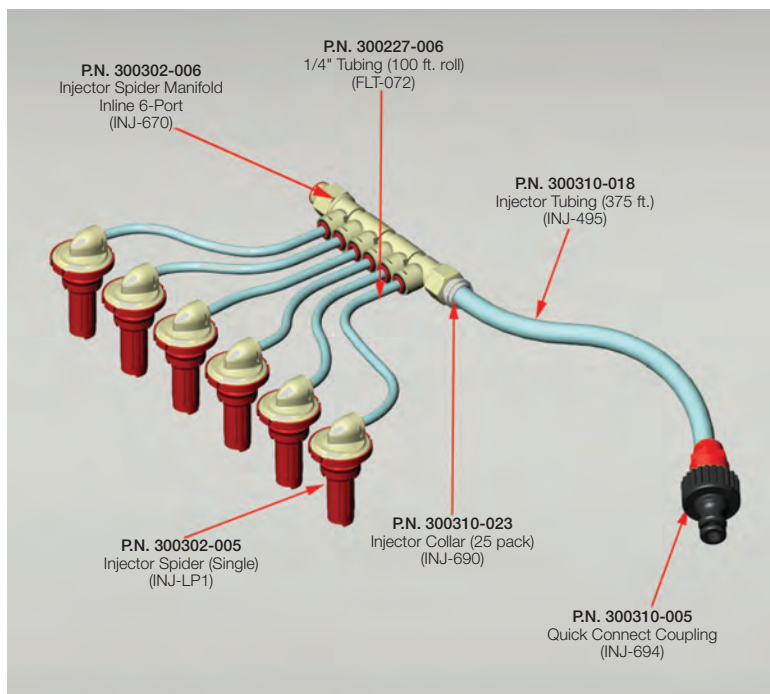



Hydro Cart Max

Part Number	Vendor Number
300302	INJ-HCT

- Supplied with 18' power cord in a retractable cord reel and 15' of 5/8" high output industrial hose.
- Submersible pump mounted inside the tank delivers all the pressure and volume required by the Water Injector System™.
- This water supply is also compatible for use with the Stealth Watering System™ and the Watering Gun.
- Additional adaptors may be required (see Optional Equipment box).



Hydro Cart Mini

Part Number	Vendor Number
300303	INJ-MINI

- Submersible pump mounted inside the tank delivers all the pressure and volume required by the Water Injector System™.
- Supplied with 13' power cord and 10' of industrial hose.
- Plugs into any 110 VAC outlet.
- Handles like a hand truck.
- This water supply is also compatible for use with the Stealth Watering System™ and the Watering Gun.
- Additional adaptors may be required (see Optional Equipment box).

Optional Equipment - Adapters & Connectors

300227-026 Stealth Adapter for Water Injector Supplies	300227-70A BFS Adapter for Water Injector Supplies	300227-70E BWT Adapter for Water Injector Supplies

300310-027 Flow-Checker Water Measurement Tool

Standard Connector
Male Quick Connect to Female Quick Connect

Injector System - Fill Options

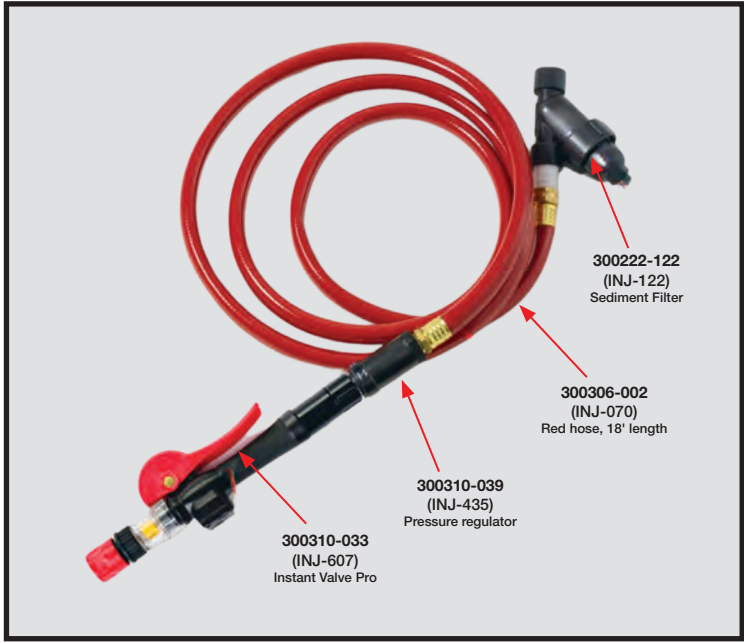

Direct Fill Hose Injector

Part Number	Vendor Number
300305	INJ-DF

- Includes an in-line sediment filter, 18 feet of high output industrial hose, a pressure regulator and an Instant Valve Pro with built in flow indicator (spinner),
- Requires a plumbing connection to a 3/4" NPT connection.
- An isolation valve is recommended to be installed at the source.
- Use a Flow Checker to be sure the output pressure is adequate for use with the Water Injector System™.
- This water supply is also compatible for use with the Stealth Watering System™ and the Watering Gun
- Additional adapters may be required (see Optional Equipment box) below.

Optional Equipment

Standard Connector				
				
Male Quick Connect to Female Quick Connect	300227-026 Stealth Adapter for Water Injector Supplies	300227-70A BFS Adapter for Water Injector Supplies	300227-70E BWT Adapter for Water Injector Supplies	300310-027 Flow-Checker Water Measurement Tool

▲ Note: The use of deionized water is recommended for all tanks.

Part No.	Vendor No.	Description	
	300227-029	INJ-688	Female Quick Disconnect
	300302-005	INJ-LP1	Water Injector Spider, Single
	300302-006	INJ-670	Injector Spider Manifold 6-Port
	300310-005	INJ-694	Input Coupling Quick Connect for Water Injectors
	300310-008	INJ-198	Injector Tubing 25 feet, 1/2" OD
	300310-010	INJ-686	Ratchet Clamp <i>Used on Terminating End of Injector Kit; also used with Wye Fitting to lock the Hose.</i>
	300310-012	INJ-693	Vent Adapter Quarter Turn
	300310-013	INJ-706	Vent Adapter DIN
	300310-015	INJ-TL1	Terminating Water Injector

Part No.	Vendor No.	Description	
	300310-016	INJ-687	Repair Coupling with Collars
	300310-017	INJ-692	Check Valve (2) <i>Quick disconnect on end of Injector System that will plug into water supply.</i>
	300310-018	INJ-495	Injector Tubing Type 375 feet, 1/2" OD <i>Quick disconnect on end of Injector System that will plug into water supply.</i>
	300310-019	INJ-L1A	Water Injector Extended Downtube
	300310-023	INJ-690	Water Injector Collar
	300310-025	INJ-691	Wye Fitting with Collars <i>Connects the Fill Hose to the Injector System.</i>
	300310-026	INJ-695	ClampLock Injector (single) with collars <i>This style of injectors push into the cell like the Stealths do; need adapter if have Douglas Battery (FLT-085) 300227-016.</i>
	300310-028	INJ-697	Injector Standard
	300310-033	INJ-607	Instant Valve Pro <i>Replaces On/Off Valve INJ-120, Nozzle INJ-121 and Instant Valve Assembly INJ-491.</i>

Injector System Supplies

	Part No.	Vendor No.	Description
	300310-034	ACC-091	Check Valve/Quick Disconnect Coupling Male
	300310-037	INJ-657	Replacement parts Kit - hoses and fittings to connect the hydrotronic to submersible pump. <i>Includes hoses and fittings to connect to the submersible pump for Charger-Mounted water supplies.</i>
	300310-038	INJ-645	Inline Regulator Assembly
	300310-039	INJ-435	Pressure Regulator
	300310-040	ACC-036	Gauge Assembly Kit for 10 gal. Bladder Tanks

Tools

	Part No.	Vendor No.	Description
	300310-009	INJ-685	Installation Tape 36 yards
	300310-014	INJ-311	Punch Tool Tubing
	300310-022	INJ-601	Collar Installation Tool
	300310-027	INJ-FC	Water Flow Pressure Measurement Tool

Battery Accessories

V-Force Small Fleet Battery Management System (BMS)

Takes guess work out of choosing next battery. Saves 2 to 5 minutes per battery change. Reduces the number of changes by 10-20%. Increases battery life by 6 months due to longer cool down times and more even battery usage. Longer life means fewer battery purchases. Audible mispicked battery alarm. Manages up to 50 chargers for each battery type. Works with High Frequency, SCR, and Ferro Resonant chargers in conventional battery changing applications. Adjustable to pool battery voltage via internal jumper. Daisy-chained data cable connections for quick non-certified install with standard tools. Required Blue LED next battery Sentinel Light (Part # 300314-SU6) sold separately. Recommended QTY of 1 per charger.

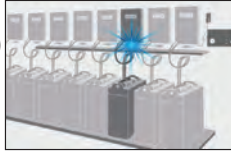

Part Number - 340640

V-Force Basic BMS Controller includes 2, 25 ft. CAT 3 Sentinel data cables and power supply with AC adaptor tips. Recommend QTY 1 for up to 50 chargers of each battery type.



Part Number - 300314-SU6

Sentinel with blue light includes 1, 7 ft. CAT 3 Sentinel data cable and couplers. Recommended QTY 1 per charger.

Battery Straps



Part No.	Description	Style
300040	Used to lift & move battery P.N. 156131 & 345012-100-SS	A
300040-003	For post terminal use only. Double grip jaws automatically lock. Non-conductive plastic strap is acid resistant.	B
300040-004	For post terminal use only. Double grip jaws automatically lock. Non-conductive plastic strap is acid resistant.	C

WARNING: Cancer and reproductive harm - www.P65Warnings.ca.gov



Tool Balance Swivel Mount

Part No.	Min.-Max. Load	Reel Weight	Cable Length
300038-005	3.0-5.0 lbs.	1.5 lbs.	6'

The BD Series Tool Balancer is an economical choice for balancing tools weighing up to 5 lbs. The molded ABS housing has a smooth exterior with rounded edges designed for maximum ergonomic appeal. The tool balancer is easy to adjust and reliable.



Battery Side-Lift Carrier

Part No.	Description
300040-002	Best quality for all battery types and sizes. Adjustable notches securely lock in place. Features bicycle grip handle and sidewall pads.

WARNING: Cancer and reproductive harm - www.P65Warnings.ca.gov



Battery Repair Parts

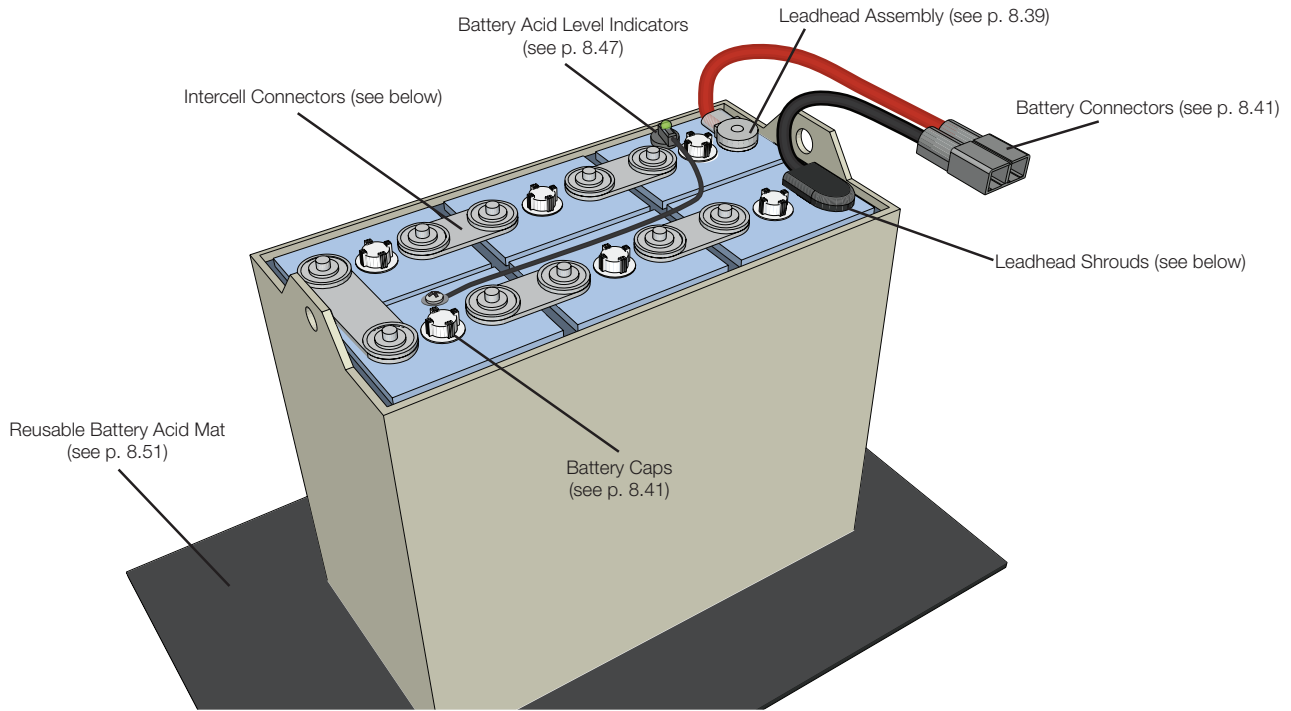

Leadhead Shrouds

Part Number	Description
Straight	
300430-001	Black
300431-001	Red
Offset, One Hole	
300426-001	Black/Right
300427-001	Red/Right
300428-001	Black/Left
300429-001	Red/Left
Offset Two Hole - 3.00" Center to Center	
300432-001	Black/Right
300433-001	Red/Right
300434-001	Black/Left
300435-001	Red/Left
Offset Two Hole - 3.75" Center to Center	
300436-001	Black/Right
300437-001	Red/Right
300438-001	Black/Left
300439-001	Red/Left
Universal	
300451	Black

⚠ **WARNING:** Cancer and reproductive harm - www.P65Warnings.ca.gov

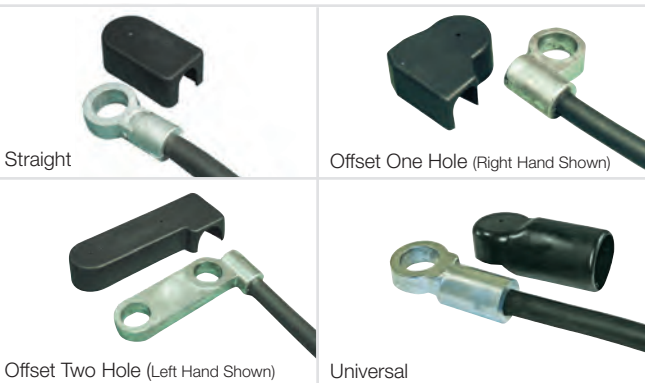

Fast Charge Leadhead Shrouds



Fast-Charge Leadhead Shrouds

Part Number	Description
300464-00R	Red
300464-00B	Black

■ Fits 2/0, 3/0 & 4/0

Intercell Connectors/Shrouds

V-Force® Intercell Battery Connectors

Part Number	Description
300402-001	3" - 2 hole connector
300402-007	3½" - 2 hole connector
300402-003	3½" - 2 hole connector
300402-002	3¾" - 2 hole connector
300402-004	5" - 2 hole connector
300402-005	5¾" - 2 hole connector
300402-006	6" - 2 hole connector

Note: length is measured center to center

⚠ **WARNING:** Cancer and reproductive harm - www.P65Warnings.ca.gov

- Safe-burning, high-conductivity lead
- 3% antimonial lead, free of voids and porosity, greater electrical conductivity



V-Force® Intercell Shrouds

Part Number	Size (Center to Center)
300424-001	3" - 3⅛"
300425-001	3½"
300425-005	3¾"
300425-004	5"
300425-007*	5¼"
300425-006*	6"
300425-002	10½ - 10¾"
300425-003	12½ - 12¾"

*Are not V-Force branded

⚠ **WARNING:** Cancer and reproductive harm - www.P65Warnings.ca.gov

Standard Cable Assemblies

Note: For Enersys Batteries, use Universal Leadhead Assemblies.

Part Number	Description	Style	
Straight			
300400-008	#2 red cable	A	
300400-007	#2 black cable		
300400-001	#1 red cable		
300400-002	#1 black cable		
300400-009	1/0 red cable		
300400-010	1/0 black cable		
300400-022	2/0 red cable		
300400-021	2/0 black cable		
300400-027	3/0 red cable		
300400-028	3/0 black cable		
300400-031	4/0 red cable		
300400-032	4/0 black cable		
Offset, 90 degree			
300400-003	#2 red cable		B
300400-004	#2 black cable		
300400-033	#1 red cable		
300400-034	#1 black cable		
300400-011	1/0 red cable		
300400-012	1/0 black cable		
300400-019	2/0 red cable		
300400-020	2/0 black cable		
300400-030	3/0 red cable		
300400-029	3/0 black cable		
300400-038	4/0 red cable		
300400-037	4/0 black cable		
Offset, 90 degree, Two Hole Posts, 3.00" Post Hole Centers			
300400-013	1/0 red cable	C	
300400-014	1/0 black cable		
300400-015	2/0 red cable		
300400-016	2/0 black cable		
300400-023	3/0 red cable		
300400-024	3/0 black cable		
300400-061	4/0 red cable		
300400-062	4/0 black cable		
Offset, 90 degree, Two Hole Posts, 3.75" Post Hole Centers			
300400-040	1/0 red cable		C
300400-039	1/0 black cable		
300400-018	2/0 red cable		
300400-017	2/0 black cable		
300400-025	3/0 red cable		
300400-026	3/0 black cable		
300400-035	4/0 red cable		
300400-036	4/0 black cable		
Offset, 90 degree, Three Hole Posts, 3" Post Hole Centers			
300400-044	1/0 red cable	D	
300400-043	1/0 black cable		
300400-046	2/0 red cable		
300400-045	2/0 black cable		
300400-050	3/0 red cable		
300400-049	3/0 black cable		
300400-054	4/0 red cable		
300400-053	4/0 black cable		
Offset, 90 degree, Three Hole Posts, 3.75" Post Hole Centers			
300400-042	1/0 red cable		D
300400-048	2/0 red cable		
300400-047	2/0 black cable		
300400-052	3/0 red cable		
300400-051	3/0 black cable		
300400-056	4/0 red cable		
300400-055	4/0 black cable		

⚠WARNING: Cancer and reproductive harm - www.P65Warnings.ca.gov

Universal Burn-on 5 ft. Leadhead Cable Assemblies

Note: Designed to be burned onto intercell connectors; use Universal Leadheads on Enersys Batteries.

Part Number	Description	Style
Straight		
300466-001	1/0 red cable	A
300466-002	1/0 black cable	
300466-003	2/0 red cable	
300466-004	2/0 black cable	
300466-005	3/0 red cable	
300466-006	3/0 black cable	
300466-007	4/0 red cable	
300466-008	4/0 black cable	

⚠WARNING: Cancer and reproductive harm - www.P65Warnings.ca.gov

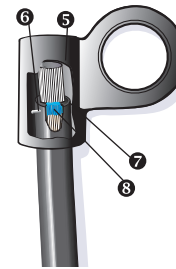
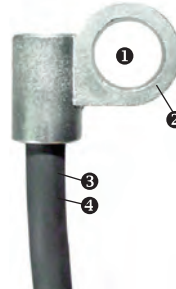

- 1 Post Hole 15/16"
- 2 5% Antimonial Lead for Durability
- 3 EPDM Insulation
Rated 600 Volt
Temperature Range: -40 +105°C
(-40 +221°F), Flame Resistant, Abrasion,
Tear and Cut Resistant, Impervious to
Battery Acid, Oil, Grease
- 4 Quickflex Cable, Soft Bare #30 Copper
Wire, Class K, Rope Stranded for
Maximum Flexibility, Conforms to
ICEA/NEMA Welding Cable Requirements,
Meets or Exceeds ASTMB-172
- 5 Copper Wire Hot Tinned for Maximum Bond
to Lead
- 6 Anti-pullback Lock Pin
- 7 Cable Deeply Embedded in Lead,
Preventing Insulation Pull-back
- 8 Internal Silicone Seal™ Silicone Seal Under
Insulation Prevents Corrosion, Sealing Out
Acid and Water

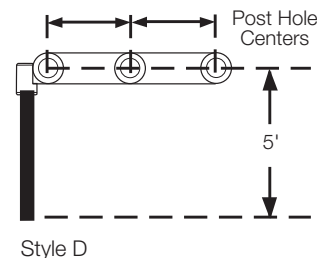
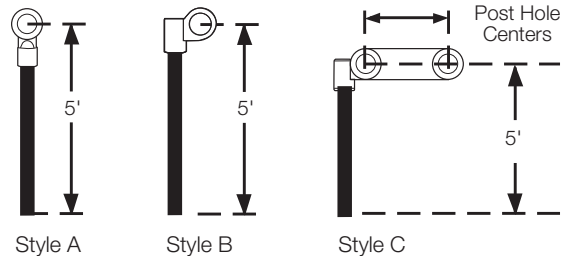

Leadheads

Fast Charge Leadheads

Part Number	Description	Style
Offset 90 degree		
300461-013	2/0 red cable	A
300461-014	2/0 black cable	
300461-015	3/0 red cable	
300461-016	3/0 black cable	
300461-017	4/0 red cable	
300461-018	4/0 black cable	
Offset, 90 degree, Two Hole Posts, 3" Post Hole Centers		
300461-001	2/0 red cable	B
300461-002	2/0 black cable	
300461-005	3/0 red cable	
300461-006	3/0 black cable	
300461-009	4/0 red cable	
300461-010	4/0 black cable	
Offset, 90 degree, Two Hole Posts, 3.75" Post Hole Centers		
300461-003	2/0 red cable	B
300461-004	2/0 black cable	
300461-007	3/0 red cable	
300461-008	3/0 black cable	
300461-011	4/0 red cable	
300461-012	4/0 black cable	

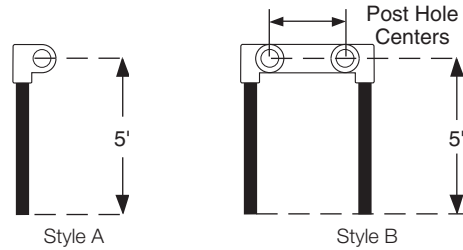
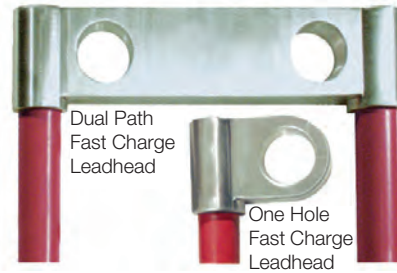

⚠ **WARNING:** Cancer and reproductive harm - www.P65Warnings.ca.gov

Bolt-on 5 ft. Cable Assemblies

Part Number	Description
300401-001	#2 red - single cable
300401-002	#2 black - single cable
300471-00R	#2 red - single cable (for Deka batteries)
300471-00B	#2 black - single cable (for Deka Batteries)
300401-011	#1 red - single cable
300401-012	#1 black single cable
300401-003	1/0 red - single cable
300401-004	1/0 black - single cable
300401-005	2/0 red - single cable
300401-006	2/0 black - single cable
300401-007	3/0 red - single cable
300401-008	3/0 black - single cable
300401-009	4/0 red - single cable
300401-010	4/0 black- single cable

Note: Cone & Fastener not included in assembly; must be ordered separately.

⚠ **WARNING:** Cancer and reproductive harm - www.P65Warnings.ca.gov



Cable Assembly



Standard Cone



Fastener



Fastener

Part Number	Description
300419	Includes 10 of each: bolt, flat washer and lock washer

Standard Cones, 5 per package (Fits all gauge sizes)

Part Number	Description
300416-001-05	1 hole
300416-002-05	2 hole - 3"
300416-003-05	2 hole - 3 3/4"
300416-004-05	3 hole - 3 3/4"

⚠ **WARNING:** Cancer and reproductive harm - www.P65Warnings.ca.gov

Safety Boots/Protective Caps



Part Number	Amp	SB/SBX
300463-050	50	SB
300463-175	175	SB
300463-350	350	SB

- Keep terminals clean



Part Number	Amp	SB/SBX
300413-050	50	SB
300413-175	175	SB
300413-350	350	SB
300462-175	175	SBX
300462-350	350	SBX

- Strain relief for cables
- Seals contacts and cable from corrosion, acid, chemicals, salt, water, and dirt
- Adjustable cable ports cut to fit cable gauge
- Does not interfere with mounting brackets, handles & protective caps
- Made of black vinyl rubber
- Operator safety
- Reduces chances of a short circuit
- Isolates negative from positive
- Ergonomic grip

Battery Caps

Part No.	Type	Color	Ht. (in)
300053-001	Screw	Yellow	1.0
300053-003	Screw	Red	1.0
300053-004	Screw	White	1.0
300053-002	Flip top w/blue lid	Blue	1.0
300053-005	Flip top w/yellow lid	Yellow	1.59
300053-006	Flip top w/blue lid	Blue	0.5
300053-008	Douglas style flip top	Black	2.75
300053-010	Bayonet Vent (Flame Arrestor)	White	1.0
300053-011	Flip Top Vent (Flame Arrestor)	Yellow	1.32
300227-082	Dust Cap	Blue	1.25

NEW!

WARNING: Cancer and reproductive harm - www.P65Warnings.ca.gov

Insulator Terminal Protectors

Part No.	Color	Fits Gauges	Post Ht. (in)
125958-001	Red	6 & 8	0.94
125958-002	Black	6 & 8	0.94
125588-001	Black	1/0 & 2/0	1.02
125588-002	Black	4 & 6	0.85
125588-003	Black	4 & 6	0.95
125588-004	Black	10	0.75
125588-005	Black	3/0 & 4/0	0.95
125588-006	Black	4/0	1.60
125588-007	Black	2 & 4	0.90

WARNING: Cancer and reproductive harm - www.P65Warnings.ca.gov

Protects against electrical system shorts. Reduces the risk of battery explosion caused by sparks. High temperature PVC construction. Color coded for easy polarity identification.

Battery Connectors

Continued ▶

50 SB Ampere

Part Number	Color	Cable Size
Connector Housing		
078723-005	Gray	NA
340054-001	Red	NA
Housing & Contact Kits		
340054-003	Red	10-12
077917-005	Gray	10-12
340054-002	Red	6
Contacts		
078724-003	NA	10-12
078724-005	NA	6
Accessories		
Part Number	Description	
Battery Connecting Handle		
120573	Red - Includes hardware	
Cable Clamp		
340056-001	Cannot be used in combination with handle	
Dust Cap		
155450	Red	

120 Ampere

Part Number	Color	Cable Size
Connector Housing		
081591	Blue	NA
Contacts		
081823	NA	2/0

180 Ampere

Part Number	Color	Cable Size
Connector Housing		
084528	Blue	NA
Kit Housing/Contacts		
084529	Blue	1/0
Contacts		
078724-002	NA	1/0



175 SB Ampere

Part Number	Color	Cable Size
-------------	-------	------------

Connector Housing

078723-002	Gray	NA
078723-004	Yellow	NA
078723-007	Red	NA
078723-008	Blue	NA
078723-010	Orange	NA

Housing & Contact Kits

077917-002	Gray	1/0
077917-004	Yellow	1/0

Contacts

300452-001	NA	2
078724-002	NA	1/0

▼ Accessories

Part Number	Description
-------------	-------------

Battery Connecting Handle

340029-002	Plastic, gray - includes hardware
340029-003	Plastic, red - includes hardware
340029-005	Steel, red - includes hardware

Cable Clamp

340056-002	Includes hardware, use without handle
168130-001	Includes hardware, used with "A Frame" handle only

Drive Block

077034	For use with Quick Disconnect
--------	-------------------------------



SB 2/0

Part Number	Description
-------------	-------------

340055-010	SB 2/0 Gray Housing
340055-011	2/0 or 70mm ² Wire Contacts
340055-009	SB 2/0 Housing and Contact Kit

Extension of the SB175 series with outer dimensions that are identical to the SB175 but has been designed on to accept a contact for 2/0 or 70mm² wire. Contacts allow for UL rated currents up to 340 amps. Genderless designs allows it to mate with itself.



350 SB Ampere

Part Number	Color	Cable Size
-------------	-------	------------

Connector Housing

078723-001	Gray	NA
078723-003	Red	NA
078723-006	Blue	NA
078723-009	Yellow	NA
078723-011	Green	NA
078723-012	Black	NA
378723-015	Orange	NA

Housing & Contact Kits

077917-001	Gray	2/0
077917-003	Red	2/0
380000	Blue	2/0
370501-689	Gray	4/0

Contacts

078724-006	NA	1/0
078724-001	NA	2/0
078724-004	NA	3/0
078724-007	NA	4/0

▼ Accessories

Part Number	Description
-------------	-------------

Battery Connecting Handle

340029	Plastic, gray - includes hardware
340029-004	Plastic, red - includes hardware
340029-005	Steel, red - includes hardware

Cable Clamp

168130-002	Includes hardware; can be used with or without handle
------------	---



160 SBE Ampere

Part Number	Color	Cable Size
-------------	-------	------------

Connector Housing

108801-005	Red	NA
108801-007	Black	NA
108801-011	Gray	NA
108801-012	Blue	NA

Housing & Contact Kits

108800S005	Red	1
------------	-----	---

Contacts

340085	NA	1
108802-002	NA	1/0

Auxiliary Contact Kit

340084	SBE & SBX
--------	-----------

Auxiliary Contact Crimp Tool Multi-Die Kit

340084-001	Crimps #6-20AWG SB, SBS, SBE, SBO, Powerpole, Saf-D-Grid, and SPEC Pak Connectors. Includes 3 dies and plastic case.
------------	--

▼ Accessories

Part Number	Description
-------------	-------------

Battery Connecting Handle

340029-002	Plastic, gray - includes hardware
340029-003	Plastic, red - includes hardware

Cable Clamp

168130-003	Includes hardware, use with or without handle
------------	---



175 SBX Ampere

Part Number	Color	Cable Size
-------------	-------	------------

Connector Housing Kit

340028-001	Gray	1/0
340028-002	Blue	1/0
340028-003	Orange	1/0
340028-004	Yellow	1/0
340028-005	Red	1/0
340028-006	Green	1/0

Contacts

108802-002		1/0
------------	--	-----

Auxiliary Contact Kit

340084	SBE & SBX
--------	-----------

▼ Accessories

Part Number	Description
-------------	-------------

Battery Connecting Handle

340029-002	Plastic gray - includes hardware
------------	----------------------------------

Cable Clamp

168130-003	Includes hardware, without handle
------------	-----------------------------------

Battery Connectors

320 SBE Ampere

Part Number	Color	Cable Size
-------------	-------	------------

Connector Housing

108801-001	Gray	NA
108801-002	Green	NA
108801-003	Red	NA
108801-004	Brown	NA
108801-006	Blue	NA
108801-008	Yellow	NA
108801-010	Black	NA

Housing & Contact Kits

108800-007	Gray	1/0
108800-001	Gray	2/0
108800-008	Blue	2/0
108800-006	Red	3/0

Contacts

308802-001	NA	1/0
108802-001	NA	2/0
108802-003	NA	3/0
108802-004	NA	4/0

Auxiliary Contact Kit

340084	SBE & SBX
--------	-----------

▼ Accessories

Part Number	Description
-------------	-------------

108437	Drive Block used on P.N. 108800-006 & 108800-009.
060015-025	Screw
060005-006	Lock washer
060021-006	Nut
108852-002	Contact Bushing used to go from 2/0 to 1/0

Battery Connecting Handle

340029	Plastic gray - includes hardware
340029-004	Plastic, red - includes hardware

Cable Clamp

168130-004	Includes hardware, use with or without handle
------------	---

▲ **WARNING:** Cancer and reproductive harm - www.P65Warnings.ca.gov



340084



340029-004



168130-004

Contact Bushing

Part Number	Description
-------------	-------------

108852-001	1/0 to 1
108852-002	2/0 to 1/0

■ Used on SB, SBE or SBX Contacts



Manual Release Handle - SBE 320/SBX 350

Part Number - H47593-533

Charger/Truck Half
(includes hardware)



Part Number - 340060-001

Battery Half
(includes hardware)



Manual Release Handle - SBX 175

Part Number - 340060-005

Charger/Truck Half
(includes hardware)



Part Number - 340060-004

Battery Half
(includes hardware)



350 SBX Ampere

Part Number	Color	Cable Size
-------------	-------	------------

Connector Housing Kit

118802-001	Gray	2/0
118802-002	Blue	2/0
118802-003	Red	2/0
118802-004	Green	2/0
118802-005	Black	2/0
118802-006	Yellow	2/0
340055-001	Blue	4/0
340055-002	Yellow	4/0
340055-003	Gray	4/0
340055-004	Red	4/0
340055-005	Gray	3/0
340055-006	Blue	3/0
340055-007	Red	3/0
340055-008	Yellow	3/0

Connector Housing

340090-001	Gray
340090-002	Blue
340090-003	Black
H24985-502	Red
340350-005	Green
340350-006	Orange
340350-007	Yellow

Contacts

108802-001	2/0
108802-003	3/0
108802-004	4/0

Auxiliary Contact Kit

340084	SBE & SBX
--------	-----------

▼ Accessories

Part Number	Description
-------------	-------------

Battery Connecting Handle

340029	Plastic, gray - includes hardware
--------	-----------------------------------

Cable Clamp

168130-004	Includes hardware, use with or without handle
------------	---



340084



340029



168130-004

Complete Kit - P.N. 139685

Includes: 2 each of H47593-533 and 340060-001 manual release handles, 1 each of 118802-001 & 118802-003 connectors with 2/0 terminals.



SB Extraction Tool

Part Number	Amps
340089-003	AWZ-C/H LV400 CAN

LV400

Crown Part Number Description

LV400 Replacement Kits	
300400-105-02	Replacement Housing Kit
300400-115-02	Replacement Plug Housing Kit
300400-105-03	Replacement Handle

A320

Crown Part Number Description

A320 Complete Kits - handle, auxiliary tips, clamp and carrier	
340320-115	A320 Conn- Male Pin, 1/0
340320-215	A320 Conn- Male Pin, 2/0
340320-315	A320 Conn- Male Pin, 3/0
340320-415	A320 Conn- Male Pin, 4/0
340320-105	A320 Conn- Female Skt, 1/0 - without handle
340320-205	A320 Conn- Female Skt, 2/0
340320-305	A320 Conn- Female Skt, 3/0
340320-405	A320 Conn- Female Skt, 4/0

A320 Kits - Do not include contact tips, auxiliary tips or handle	
146345-001	A320 Kit- Male Pin Hsg, Clamps, Carrier
340320-201	A320 Kit- Female Skt Hsg, Clamps, Carrier

A320 Connectors with Contacts	
340320-112	A320 Conn- Male Pin, 1/0
340320-212	A320 Conn- Male Pin, 2/0
340320-312	A320 Conn- Male Pin, 3/0
340320-412	A320 Conn- Male Pin, 4/0
340320-102	A320 Conn- Female Skt, 1/0
340320-202	A320 Conn- Female Skt, 2/0
340320-302	A320 Conn- Female Skt, 3/0
340320-402	A320 Conn- Female Skt, 4/0

A320 Auxiliary Tips	
340320-012	A160/320 Aux Pin Contact, Lower #10 6mm AWG
340320-013	A160/320 Aux Pin Contact, Upper #12 4mm AWG
340320-002	A320 Aux Pin Contact, Lower, 14/18 AWG
340320-003	A320 Aux Skt Contact, Lower, 14/18 AWG
340320-004	A320 Aux Pin Contact, Upper, 14/18 AWG
340320-005	A320 Aux Skt Contact, Upper, 14/18 AWG

A320 Contact Tips	
340320-006	A320 Contact, Male Pin, 2/0
340320-007	A320 Contact, Male Pin, 3/0
340320-008	A320 Contact, Male Pin, 4/0
340320-009	A320 Contact, Female Skt, 2/0
340320-010	A320 Contact, Female Skt, 3/0
340320-011	A320 Contact, Female Skt, 4/0

A160

Crown Part Number Description

A160 Complete Kits - handle, auxiliary tips, clamp and carrier	
341227-115	A160 Conn- Male Pin, 1/0
341227-125	A160 Conn- Female Skt, 1/0

A160 Kits - Do not include contact tips, auxiliary tips or handle	
341227-112	A160 Conn- Male Pin, 1/0
341227-122	A160 Conn- Female Skt, 1/0

A160 Auxiliary Tips	
340320-012	A160/320 Aux Pin Contact, Lower #10 6mm AWG
340320-013	A160/320 Aux Pin Contact, Upper #12 4mm AWG

A160 Contact Tips	
154292-001	A160 Contact, Male Pin 1/0
341227-002	A160 Contact, Female Pin 1/0

A160/A320

Crown Part Number Description

340333	DIN Voltage Key 160/320A Standard
--------	-----------------------------------

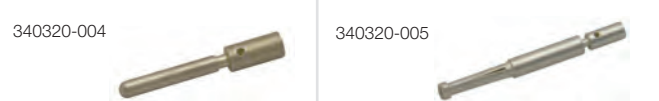
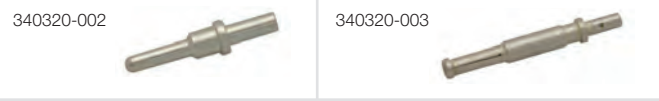
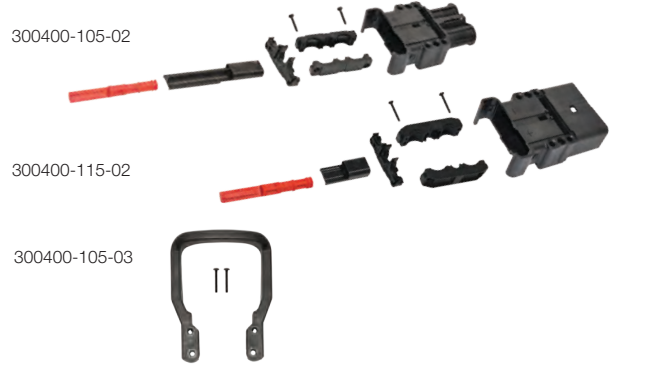

Battery Connectors - EURO and DIN

A320/A160 Tools and Accessories

Crown Part Number	Description
340320-001	A160 & A320 Handle
340327	Latch Plate w/hardware
340328	A-Frame Handle for Latch, w/hardware
340329	Hand Crimp Tool - crimps auxiliary DIN contacts

A320 (only) Tools and Accessories

Crown Part Number	Description
340060-002	A320 Manual Release Brkt. Battery half
340060-003	A320 Manual Release Lever, Charger/Truck Half
340321	Crimp Tool-A320 Aux Contacts
340323	Crimp Tool-Battery Powered; hand held hydraulic tool that uses dies 340325 & 340326
340324	Crimp Tool-Hand held hydraulic tool that uses dies 340325 & 340326
340331	Die Set - 6-12 guage - use with 340321
340325	Die Set-2/0 - use with 340323 & 340324
340326	Die Set-3/0-4/0 - use with 340323 & 340324
352236	Couple/Adapter Female Euro 320



340320-001

340327



340328



352236

LV500 Ampere

Part Number	Color	Description
Connector Housing		
340500-105	Blue	LV500 Battery Socket
340500-115	Blue	LV500 Charger Plug



Battery Socket



Charger Plug

LV400 Ampere

Part Number	Color	Description
Connector Housing Kit with Coding Pin, Pilot and Auxillary Contacts		
340400-105*	Black	LV400 Battery Socket for 4/0 (95MM2) Cable
340400-115**	Black	LV400 Charger Plug for 4/0 (95MM2) Cable
364984-001	Red	Battery Socket and Charger Plug Replacement Coding Pin



Battery Socket



Charger Plug

*V-Force LI1100 Replacement Charge Port Connector

**Lithium Ion Charge Harness Replacement Battery End Connector

DIN320 Ampere

Part Number	Color	Description
Connector Housing Kit with Coding Pin, Pilot and Auxillary Contacts		
339320-105	Black	DIN320 Battery Socket Kit for 4/0 (95MM2) Cable
339320-115	Black	DIN320 Charger Plug for 4/0 (95MM2) Cable
164980-002	Blue	Battery Socket Replacement Coding Pin
164980-001	Blue	Charger Plug Replacement Coding Pin

Power Cable

Gauge	Color	UL Rated	Bulk Part Number	10 ft box 305 cm	12 ft box 366 cm	50 ft reel, 1,524 cm	100 ft reel, 3,048 cm	250 ft reel, 7,620 cm	500 ft reel, 15,240 cm
6	black	UL	084568-010		384568-012				
4	black	UL	084569-105	384569-010	384569-012	384569-050	384569-105	384569-250	
4	red	UL	384575-001		384575-012	384575-050	384575-100		
2	black	UL	084570-100		344570-012	344570-050	344570-100		344570-500
2	red	UL	384576-001		384576-012	384576-050	384576-100		
1	black	UL	084571-100		344571-012	344571-050	344571-100		
1	red	UL	384571-001		384571-012	384571-050-02	384571-100-02		
1/0	black	UL	084572-021		384572-012	384572-050	384572-100		
1/0	red	UL	384574-001		384574-012	384574-050	384574-100		
2/0	black	UL	084573-013		384573-012-B		384573-100	384573-250	
2/0	red	UL			384573-012-R		384573-100-02	384573-250-0R	
2/0	red	not UL	384573-013R		384573-012R		384573-013		
2/0	orange	not UL	384573-014O		384573-012-O		384573-014		
3/0	black	UL			384579-012-B		384579-100-01		
3/0	red	UL			384579-012-R		384579-100-02		
4/0	black	UL	384577-100-01		384577-012		384577-100		
4/0	red	UL			384577-012-R		384578-100-02		
4/0	red	not UL	384578-100-01		384578-012		384578-100		



⚠️ **WARNING:** Cancer and reproductive harm - www.P65Warnings.ca.gov



Cable End - Copper Tin Plated

AWG	Wire Size	Stud Size	Description	Part Number
4	0.344	0.344	straight	384000-004
6	0.344	0.344	straight	384000-006
1/0	0.344	0.344	straight	384000-001
2/0	0.344	0.344	straight	384000-002
3/0	0.344	0.344	straight	384000-003
4/0	0.344	0.344	straight	384000-040
4	0.344	0.344	90° angle	384001-003
6	0.344	0.344	90° angle	384001-004
1/0	0.344	0.344	90° angle	384001-001
2/0	0.344	0.344	90° angle	384001-002



384000-XXX



384001-XXX

Expandable Sleeving - White

Part Number	Size	Expansion Range (Min. - Max.)
300474-100	1/2" - 100 ft. roll	1/4" - 3/4"
300475-075	3/4" - 75 ft. roll	1/2" - 1 1/4"
300476-050	1 1/4" - 50 ft. roll	3/4" - 1 3/4"
300477-050	1 3/4" - 50 ft. roll	1 1/4" - 2 1/2"
300478-050	2" - 50 ft. roll	1 5/8" - 2 3/8"

⚠️ **WARNING:** Cancer and reproductive harm - www.P65Warnings.ca.gov

- Highly wear resistant; Resists acids, bases, solvents and fuels
- Flammability Rating UL-94, FAR25, V-O
- Cut and abrasion resistant
- Ultra light weight
- Expands up to 150%

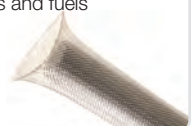

Automotive Battery Connectors, 10 per package

Part Number	Single Piece	Description	Specifications
300457-010	300457-001	Heavy Duty Universal Top Post Lead Terminal	Clamps designed for truck, bus, construction, agriculture & industrial applications. Accepts 1 thru 4/0 gauge cable sizes.
300458-010	300458-001	Automotive Universal Top Post Lead Terminal	Automotive and light truck applications. Accepts 6 thru 2/0 gauge cable sizes.

⚠️ **WARNING:** Cancer and reproductive harm - www.P65Warnings.ca.gov



300457-010



300458-010

Expandable Sleeving - Black

Part Number	Size	Expansion Range (Min. - Max.)
300467-050	3/4" - 50 ft. roll	5/8" - 1"
300467-100	3/4" - 100 ft. roll	5/8" - 1"
300456-100	1 1/4" - 100 ft. roll	1" - 1 1/2"

⚠️ **WARNING:** Cancer and reproductive harm - www.P65Warnings.ca.gov

- Fray resistant, cuts with scissors
- High abrasion resistance
- Increased braid density for better coverage
- Will fit both negative & positive cables from 1 gauge to 4/0 gauge



Expandable Sleeving - Red

Part Number	Size	Expansion Range (Min. - Max.)
300468-075	3/4" - 75 ft. roll	3/4" - 1 1/4"
300468-250	3/4" - 250 ft. roll	3/4" - 1 1/4"
300469-050	1 1/4" - 50 ft. roll	3/4" - 1 3/4"
300469-250	1 1/4" - 250 ft. roll	3/4" - 1 3/4"

⚠️ **WARNING:** Cancer and reproductive harm - www.P65Warnings.ca.gov

- Cut and abrasion resistant
- Resists gasoline, engine chemicals and cleaning solvents
- Economical and easy to install
- FMVSS 302 Approval
- Not anti-fray



Cable Ties

Part Number	Length (in)	Width (in)	Max. Wire Bundle	Color	Qty Per Box
365003-002	3.62	0.09	0.63	Natural	1000
365003-003	7.44	0.19	1.75	Natural	1000
365003-004	5.60	0.14	1.38	Black	1000
365003-005	11.40	0.14	3.00	Black	1000
18108-X	14.00	0.3125	4.00	Black	100



Power Cable and Accessories

Heat Shrink Tubing



Part Number	Color	Expanded Dia. (in)	Shrunk Dia. (in)	Gauge Size	Length
300414-001	Black	0.75	0.25	4 thru 2/0	6 in.
300414-005-04	Black	0.75	0.25	4 thru 2/0	4 ft.
300414-002	Red	0.75	0.25	4 thru 2/0	6 in.
300414-006-04	Red	0.75	0.25	4 thru 2/0	4 ft.
300414-003	Black	1.125	0.375	1/0 thru 4/0	6 in.
300414-007-04	Black	1.125	0.375	1/0 thru 4/0	4 ft.
300414-004	Red	1.125	0.375	1/0 thru 4/0	6 in.
300414-008-04	Red	1.125	0.375	1/0 thru 4/0	4 ft.

⚠ **WARNING:** Cancer and reproductive harm - www.P65Warnings.ca.gov

- Double-wall with extra meltable sealant
- Premium quality for heavy duty applications or for use in abusive environments requiring protection from abrasion
- Inner surface lined with adhesive sealant which melts when heated; permanently seals connection as tube cools & shrinks
- Conforms to DOD Mil-DTL-23053/15A Class 1 & 2 specifications

Gum Rubber Tubing

Part Number Description

300483-050	Highly flexible, seamless tubing free of curvature with a non-slip outside finish for easy handling. Resists weak acids, alkalis and salts. Highly abrasion resistant.
------------	--

- 1/4" ID x 1/8" 50 ft.



Cable Wrap

Part Number Description

369503	Cable Loom (Spiral)
--------	---------------------



Battery Acid Indicators

Blinky

Part Number Probe Length

340011-007	2.35"
340011-008	5"

Blinky Basic option is a low-cost solution for accurate electrolyte monitoring. The LED is twice as bright as the previous model and the housing is more robust. LED blinks green when the electrolyte level is good and goes out when water is required.



CEC Approved

Smart Blinky

Part Number Probe Length

340011-009	2.35"
340011-011	5"
340011-017	2.35" with Flexitap

Ideal for batteries where the top of the battery can be seen. The LED is 8 times brighter than the previous model. The electrolyte probe and LED are integrated into the same housing. The LED blinks green when the electrolyte level is good and blinks red when water is needed. The design has an "installation forgiveness zone!" This system works on 6V and 12V block and golf cart batteries.



CEC Approved

NEW!

Smart Blinky Pro

Part Number Probe Length

340011-012	2.35"
340011-015	5"

Intelligent battery monitoring with both light and sound. SmartBlinky Pro provides a bright electrolyte level indicator to know when to fill a battery. The LED is mounted on the battery cable near the connector for maximum visibility - perfect for opportunity and fast applications in which the battery never leaves the truck. SmartBlinky Pro is rugged, built to withstand the harsh environment of industrial battery applications, and UL classified.



CEC Approved

Smart Blinky Remote

Part Number Probe Length

340011-010	2.35"
------------	-------

Ideal for batteries that do not leave the truck or batteries that are changed on multi-level racks because the indicator LED can be edge mounted for high visibility. The LED is 6 times brighter than the previous model. The LED housing has a lower profile and is more robust. The LED blinks green when the electrolyte level is good and blinks red when water is needed. The design has an "installation forgiveness zone!" This system works on 6V and 12V block and golf cart batteries.



CEC Approved

Battery Tools

Continued ▶



QuickStrip Pro - Cable Strippers

Part Number - 300412

- Strips insulation from cable 10 - 250 mcm
- Includes spare blade

Replacement Blade: P.N. 300412-001

⚠ **WARNING:** Cancer and reproductive harm - www.P65Warnings.ca.gov



QuickStrip - Cable Strippers

Part Number - 300411

- Strips insulation from cable 10 - 4/0 gauge
- Includes spare blade

Replacement Blade: P.N. 300418

⚠ **WARNING:** Cancer and reproductive harm - www.P65Warnings.ca.gov

Post Drill Bit, 2 Flute

Part Number - 300404

Designed for Leadheads, FastCharge Leadheads and Intercells.

- Extra tall flutes allow drilling depth of up to one inch
- 1 inch O.D. leaves a .70 inch post
- Tool length 5 inches
- Center pin to guide drill straight
- Can be resharpened
- Use centerless drill for deep bore
- Use Penetrating Lubricant: P.N. 363104-001

- 1 Three flats on shank prevent spinning in chuck
- 2 Extra tall flutes improve drilling depth in thick leadheads; Wide flutes prevent chip pile-up
- 3 Electroplating improves corrosion resistance



Post Builder Mold

Part Number - 300405

- Create a post on batteries or intercells
- Post mold is tall enough that when leadhead is attached, the post will burn down and fill leadhead cavity, creating tight seal
- Enables you to add a leadhead where needed

- 1 Tapered mold for ease of release
- 2 Handle to break mold free from new post

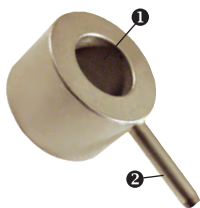

Solder Pellets

Part No.	Description
362402-033	1/0 Black Solder Pellet
362402-034	2/0 Orange Solder Pellet
362402-035	3/0 Purple Solder Pellet
362402-036	4/0 Yellow Solder Pellet

Used instead of hex crimper for tasks such as soldering battery contact tips to cables



Butane Torch

Part Number - 300408

Butane Torch used for heat shrink applications along with soldering of some smaller connectors. Not used to repair batteries.



Torque Wrench 10Nm-60Nm

Part Number - 360069



Battery Tester

Part Number - 320070

100 amp battery tester. 300 amp extended jaw. Tests: battery load tests, starters & alternators, battery state of charge.



Fluke 325 True RMS Clamp Meter

Part Number - 109040

Rugged, reliable True-RMS clamp meter with DC current and frequency measurements. Measures AC and DC voltages to 600 V. Measured AC and DC current to 400 A. Provides True RMS AC voltage and current for accurate measurements on non-linear signals. Measures frequency to 500 Hz. Measures resistance to 40 kilo-ohms with continuity detection.



PVC Battery Fluid Syringe

Part Number - 369502



Hydrometer - Glass

Part Number - 300406

- Professional quality for highest accuracy
- Precision graduated specific gravity float
- Overall Length 13.5 inches, glass barrel 8 inches long



Hydrometer - Glass

Part Number - 300406-001

- Scientifically designed and precisely calibrated
- Float has a specific gravity range of 1.100 to 1.300
- Overall length of the set is 12 inches



Hydrometer - Plastic

Part Number - 300407

- Professional quality for highest accuracy
- Precision graduated specific gravity float



10mm x 1.5 Bottom Tap

Part Number - 322270



Parking Block - Recycled Rubber*

Part Number	Description
360039-585	71-3/4" x 5-3/4" x 4"
360039-7393	47-1/4" x 5-3/4" x 4"



* Available only to customers in USA



Lead Sticks

Part Number - 300417-035 (35 - 1 lb sticks)

- Made of 5 percent antimonial lead
- Clean melting alloy, free of foreign material, voids and porosity
- Sticks are 12 inches long (30.5 cm) and weigh 1lb (.45 kg)

⚠ **WARNING:** Cancer and reproductive harm - www.P65Warnings.ca.gov



Carbon Arc Burner

Part Number - 300440

- No Flame
- Use voltage from battery to melt lead to repair battery

▼ **Accessories**

Copper Coated Electrodes

Part Number - 300441-050

- For use with Carbon Arc Burner
- 50 in a box

⚠ **WARNING:** Cancer and reproductive harm - www.P65Warnings.ca.gov



Hole Cutter

Annular Cutters - Hougen

Part Number - MSC98382922

Diameter: 1 5/16". Cutting depth: 1/2".

Precision ground to produce burr-free holes up to 1/2" deep. Ideal for electrical, piping, conduit, sheet metal & HVAC applications. High-speed steel provides good wear resistance and can be used in general purpose applications for both ferrous and nonferrous materials.

Hole Cutting Tool Arbor

Shank with Pilot Pin - Hougen

Part Number - MSC98380876

Minimum tool diameter compatibility: 1 5/16". Maximum tool compatibility: 1 1/2". Shank diameter: 1/2". No. of flats: 3. Material: Steel. Weldon flat: No.

Straight shanks are used for general purpose applications. The shank is smaller than the drill bit diameter. They are used with portable drills and drill presses on ferrous and nonferrous materials.



Weldex 113 Plier

Part Number - 306442

- Designed for the safe and easy removal of contacts from the SB or SBX connectors
- Works on either 175 or 350 Connectors



Brute Hammer Crimper

Part Number - 300465

- Use with hammer, vise or press
- Crimps 8 thru 4/0 guage connectors
- Spring loaded pin locks in "up" position for loading connector and cable. When released, pin holds connector securely during crimping.
- 6-month warranty



T-Handle with 10mm thread

Part Number - 352228

Used for removing V-Force lithium-ion model V-LI1100 modules and V-Force lead-acid models V-LA1120 and V-LA1130 lead-acid cells.



Adjustable Torquing Screw Driver

Part Number - 360043-015

Torques from .5 - 4.5 Newton Meters / 50-450 Newton Centimeters. Used for servicing V-Force HFM3 charger electrical connections.



Long 1/4" Hex, 3mm Bit

Part Number - 360043-016

Used for servicing V-Force HFM3 charger electrical connections.



1/4" Drive Metric Hex Bit Sockets

Part Number	Description
360043-007	1/4" Drive 2mm Hex Bit
360043-008	1/4" Drive 2.5mm Hex Bit
360043-009	1/4" Drive 3mm Hex Bit
360043-010	1/4" Drive 4mm Hex Bit
360043-011	1/4" Drive 5mm Hex Bit

Used for servicing V-Force Lithium Ion Batteries with 1/4" Drive Socket Set P.N. 322000.



360061



360062



360063



360064



360065



360066



360067



360068

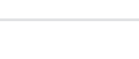

360069

These tools are designed to improve safety on electrical jobs with UL classified non-conductive composite.

- Exceeds all ISO and ASME strength and performance requirements for standard steel tools
- Individually tested to ensure protection up to 1000Volt AC and 1500 Volt DC
- UL Classified
- Lifetime warranty for material and workmanship

Part No.	Description
360061	Insulated Socket Set - Standard Includes: Sockets 3/8", 7/16", 9/16", 5/8", 11/16", 3/4"; Ratchet & Kit Bag
360062	Insulated Socket Set - Metric Includes: Sockets 10mm, 13mm, 15-19mm, 22mm; Kit Bag
360063	Non-Conductive Screwdriver set - Includes: Flat tip Screwdrivers 3/16", 1/4" 9/32"; Phillips Screwdrivers #1, #2, #3
360064	3/8" x 3" Extension
360065	3/8" x 6" Extension
360066	1/2" x 3/8" Adaptor
360067	Non-Conductive Needle Nose Pliers
360068	JHWR-24A Tool Pouch
360069	Torque Wrench 10Nm - 60Nm
360070	Battery Tool Bag for all of the above parts



360068



360069



360070

Battery Tools



Clamp

Part Number - 320056

- Use two of these clips to lift out battery cells.
- See DP module for instructions.



Cell Puller

Part Number - 320056-003

- Tool used to aid in removal of battery cells. Recommended quantity: 2.
- 500 lb. capacity



Cell Jar Puller

Part Number - 320056-004

- Tool used to aid in removal of battery jars. Recommended quantity: 2.
- 500 lb. capacity



Cell Pressure Tester

Part Number - 320075

- Test battery cells for leaks.
- Attach to the vent well, squeeze the bulb gauge, and indicator will show pressure.



Hex Crimp 24 inch

Part Number - 300410-002

- Crimps 8 thru 4/0 gauge cable
- Crimps all major brands of connectors
- Hand held
- 24 inch handles
- Lifetime warranty

26" Hex Crimp Repair Kit

Part Number - 300410-001

- Includes 2 dies, 2 springs, 2 pins and 2 washers



Carrying Case for Crimp Tools

Part Number - 300454



Quick Cutter 2 - Heavy-Duty Cutter

Part Number - 300409

- Hand held
- Cuts cable up to 6/0 gauge
- 22 inch handle for easier cutting
- Blades made of 1075 carbon steel, hardened for long life, can be resharpened
- Made in North America
- 2-year warranty

Oxygen & Acetylene Torch Welding & Regulator Kit

Part Number - 300442

Includes:

- Cylinder Carrier
- WH270FC-V Torch Handle
- CA270-V Cutting Attachment
- 150 Series Regulators with 2" Gauges
- 0-3-101 Cutting Tip
- 2-W-1 Welding Nozzle
- Hose
- Striker
- Goggles
- 20 cu. ft. Oxygen Cylinder
- MC Acetylene Cylinder
- Gas Not Included



▲ **WARNING:** Cancer and reproductive harm - www.P65Warnings.ca.gov

Replacement Parts for 300442, Oxygen & Acetylene Torch Kit

Part Number	Description	Quantity
300443	Welding Nozzle, 0-W-1	1
300445	Cutting Attachment	1
300446	Welding Handle	1
300447	Regulator Oxygen	1
300448	Regulator Acetylene	1
300449	3/16" x 12-1/2" Hose Twin	1

▲ **WARNING:** Cancer and reproductive harm - www.P65Warnings.ca.gov



Coolant/Battery Acid Refractometer

Part Number - 390221

Portable Coolant Refractometer, Coolant/Battery Acid 1.15 to 1.30. Specific Gravity of Battery Acid. Measures the freezing point of coolants and the charge condition of batteries.

▲ **WARNING:** Cancer and reproductive harm - www.P65Warnings.ca.gov

Battery Lifting Strap Kit

Part No.	Description
360044-002	Battery Lifting Strap Kit
300136	Ratchet Loadstrap
360044-001	3000 lb Capacity Battery Cell Extractor Strap w/Compact Hook
360044	5300 lb Capacity Battery Cell Extractor Strap w/Hook



360044-002



300136



360044

NEW!

5,000 Capacity Sling

Part Number - 369505



Wash Water Neutralizer

Part Number Sales Unit

300415-005 | 5 Gallon



Used to adjust pH in wash water and clean acid contaminated floors and equipment such as battery racks and delivery vehicles.

- Concentrated sulfuric acid neutralizer
- Non-corrosive and non-hazardous
- Allows for reuse of wash water
- Can also be used to remove acid from concrete floors
- Use on Reusable Battery Acid Floor and Counter Mat P.N. 300403-050



*Wash Water

Reusable Battery Acid Floor and Counter Mat

Part Number Size (ft)

300403-050 | 3 x 50 roll (can be cut easily)

- Absorbs 6 oz. of acid per square foot
- Cut to size for battery compartments, storage racks or drip pans
- Mat absorbs acid but won't leak through tough polypropylene backing
- Electrically isolates battery, preventing parasitic discharge
- Use on floor or under the battery
- Use mat over and over again

*Note: Use Wash Water Neutralizer P.N. 300415-005 on mat and sweep it up with shop vac.

Battery Cell Bag

Part Number Description

300481-025 | 24" x 36" - 25/box

300482-025 | 24" x 48" - 25/box

Image Not Available

Extra heavy-duty Poly Bags are puncture resistant and recommended for transporting industrial battery cells. Bags are manufactured from 100% virgin, high clarity polyethylene film. Meets FDA and USDA specifications. Close bags with twist ties, bag tape or by heat sealing.



Battery Protector

Part Number Sales Unit

363125-001 | Net wt 15 oz Can

Heavy-duty industrial, non-methylene chloride, battery protector extends battery life and prevents corrosion. It provides an air-tight, waterproof seal, and resists oil, gasoline, dirt, grease and heat. Assures maximum electrical connectivity.



Battery Cleaner

Part Number Sales Unit

363124-001 | Net wt 18 oz Can

Heavy-duty industrial battery cleaner is engineered for fast, effective, economical maintenance of storage battery terminals, hold-downs, cables and battery boxes. It detects leaks by changing from yellow to reddish purple when it comes in contact with acid.

⚠ WARNING: Cancer - www.P65Warnings.ca.gov

Industrial Battery Cleaner/ Neutralizing Wash Cleaner

Part Number Sales Unit

300422-001 | Quart

300422 | 5 Gallon

300422-035 | 35 Gallon



- Dissolves corrosion, eliminates acid shorts
- Stops damaging corrosion
- Allows for reuse of wash water
- Safe to use on all industrial and starter batteries
- Neutralizing Wash Cleaner with color change, turns purple when acid is present and back to yellow when safe

Wash Cleaner color indicates when acid is neutralized.

Acid Present Neutralizing Safe

Note: Protective acid resistant goggles and gloves are recommended.

Acid Spill Absorber and Neutralizer

Part Number Sales Unit Absorbs

300421 | 25 lbs. | 6 gallons of electrolyte

300421-030 | 160 lbs. | 40 gallons of electrolyte



- Specifically formulated to absorb and neutralize battery acid, with color change to show when acid is neutralized and safe for disposal
- Ideal for use in acid drip pans
- Safe and non-hazardous
- Sweeps up clean and dry, is not dusty like kitty litter/clay
- Durable easy to store container with resealable lid
- Instructions and MSDS included See OSHA 1926.441 & 1910.173

Black Battery Reconditioner

Part Number Sales Unit

363133-001 | Net wt 12 oz Can



Restores battery to original look. Formulated to adhere to battery plastics and metal. Ideal for automotive, truck and industrial batteries. When dry, paint finish resembles gloss of original molded plastic. Industrial grade, high solids for single coat coverage, outstanding hardness and durability, resists abrasion and heat. Fast drying. Other uses include battery hold-downs, trays and cases.

Apron*

1 Apron

Part Number Description

365260-001 | Black heavy weight Neoprene apron, excellent protection against acids, oils, and chemicals. Reinforced 65/35 Cotton/Polyester blend backing. 4 grommets & polyester string ties. 18 oz. weight (heavy weight). 35" x 45"



* Available only to customers in USA

Battery Service Supplies

Battery Spill Kit*

Part Number - 300035

▲ Individual Items

Part Number	Description	Quantity
300042	Faceshield	1
300041	Headgear	1
300049	32 oz Acid neutralizer (per bottle)	2 bottles
300043	Acid spill absorbent cleanup pads	10
300047	Yellow heavy-duty chemical disposal bag; 33" x 39"	1
300048	Mini broom	1
300051	16 oz eye wash flush**	1 bottle
300044	Green acid resistant glove, nitrile	1 pair
300045	Acid-resistant sleeve	1 pair
300050	Acid-resistant rubber overboot	1 pair
300046	Acid-resistant apron	1
300035-001	Bucket	1



Three-year shelf life. **Notes: Individual part numbers sold by piece or pair; Instructional label inside lid.



16 Gallon Eye Wash Station*

Part Number	Sales Unit
365466	1 kit

Size: 20.5" length, 18" width, 20.5" height. 15 minute flow, required by ANSI Z358.1-2009. Includes steel wall bracket, 2 oz. sterile water solution, and test log and drainage hose. Drain and refill every 4 months with 2 oz. solution, part number 365474.



Eye Wash Station*

Part Number	Sales Unit
365468	1 kit

Two bottle wall-mounted eye wash station. Includes two 16 oz. bottles of sterile eye wash. Easily mounts to any wall.



Water Additive*

Part Number	Sales Unit
365474	8 oz. bottle/12 case

Add to water for 16 gallon eye wash station to eliminate contamination from stagnant water. 8 oz. per 16 gallon refill.



Replacement Bottle of Eye Wash*

Part Number	Sales Unit
365469-001	One 16 oz. bottle

Sterile eye wash. Can be used alone or with 365468 eyewash station.

*Available only to customers in USA

Now Available:



"6" Velocity Wheel Assemblies

See Wheel & Tire Section
(pg. 11.05-11.06)



Ear Muffs for Hard Hat

See Safety Section
(pg. 2.09)



5,000 Capacity Sling

See Battery Section
(pg. 8.50)



Section 9

Tools

Contents

Crown Branded Tool Program	9.02
Mechanical Tools	9.05
Hydraulic Tools	9.09
Drive Tools	9.13
Diagnostic Tools	9.14
Steering Tools	9.16
Brake Tools	9.17
Electrical Tools	9.18
Wheel Chocks/Cribbing Material	9.21
IC Lift Truck Tools	9.22
Miscellaneous	9.23

New Items:

Rivet Nut Tool Set - p. 9.05
Borescope - p. 9.08
Molding Insertion Tool - p. 9.08
Adapter A9 (FPK to VG8) - p. 9.12
Steering Adapter Tool - p. 9.13
UV LED Flashlight - p. 9.16
CD-9 Diagnostic Cable - p. 9.23

Battery Tools
(See Section 8 - Battery and Charger)

Note: 1910.178(q)(5) (1998) of the Occupational Safety and Health Act (OSHA) requires that "All parts of any such industrial truck requiring replacement shall be replaced only by parts equivalent as to safety with those used in the original design."

The installation onto a lift truck of non-certified electronic components may invalidate a truck's UL EE or LPS listing and could pose a safety risk. Customers with UL-listed lift trucks are solely responsible for ensuring compliance with UL for field modifications. The selection of non-OEM parts is made solely by the customer with the awareness that OEM parts are available. Crown Equipment Corporation is unaware of what testing and/or certification, if any, the non-OEM parts have undergone and disclaims all warranties and representations regarding any non-OEM part.

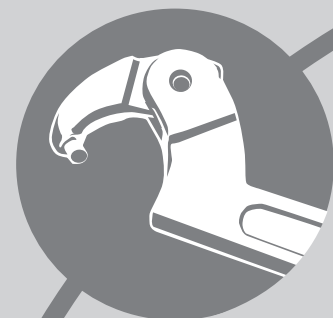

The Crown tool program offers high quality tools selected specifically for technicians to handle most lift truck repairs. Each item offered in the Crown tool kit is individually labeled with the Crown logo and Crown part number.



Part Number - 322999



Part Number - 322996

Mechanics Tool Kits

Both kits include 212 pieces — all parts on this page and next 2 pages marked with *

See page 9.05 for personal hand trucks used to carry tool bags.



1/4" Drive Socket Set (39 pieces)*

Part Number - 322000

Includes: Ratchet, Universal Joint, Drive Extensions 1-1/2" and 6", Adaptor 1/4" Female to 3/8" Male, Drive Spinner Handle, 12 Point Shallow Sockets 5/32" thru 9/16", 12 point Deep Sockets 5/32" thru 9/16", 12 Point Shallow Sockets 4mm thru 14mm.

Note: Lifetime warranty.



3/8" Drive Socket Set (72 pieces)*

Part Number - 322040

Includes: Ratchet, Universal Joint, Drive Extensions 3" and 5", Adaptor 3/8" Female to 1/4" Male, Adaptor 3/8" Female to 1/2" Male, Adaptor 1/2" Female to 3/8" Male, Drive Spinner Handle, 12 Point Shallow Sockets 5/16" thru 7/8", 12 Point Deep Sockets 5/16" thru 3/4", 12 Point Shallow Sockets 6mm thru 19mm, 12 Point Deep Sockets 6mm thru 19mm, Hex Head Drivers 1/8" thru 3/8", Torx Drivers T10 thru T55, Spark Plug Sockets 5/8" & 13/16".

Note: Lifetime warranty.



Screwdriver Set (11 pieces)*

Part Number - 322150

Includes: Flat Head - 0.018" x 3", 3/16" x 3", 1/4" x 4", 5/16" x 6", 1/8" x 6". Phillips - #0 x 3", #0 x 6", #1 x 3", #2 x 4", #3 x 6". Gasket Scraper 5".

Note: Lifetime warranty.



Ratcheting Screwdriver

Part Number - 322228

High-impact plastic handle. Heavy-duty 3-way on-off locked ratcheting mechanism. Magnetic, stainless steel shank. Bit storage in handle.

Note: Lifetime warranty.



Pliers Set (4 pieces)*

Part Number - 322140

Includes: Needle Nose Pliers, Gripping Pliers, Side Cutter, Arc Joint Pliers.

Note: Lifetime warranty.



Combination Wrench Set - SAE (13 pieces)*

Part Number - 322170

Includes: 1/4", 5/16", 3/8", 7/16", 1/2", 9/16", 5/8", 11/16", 3/4", 13/16", 7/8", 15/16", 1". 15° offset box end knuckle clearance. Made of heat-treated alloy steel for strength exceeding ANSI specifications.

Note: Lifetime warranty.



Hex Wrench Set - L Type, SAE Ball (13 pieces)*

Part Number - 322113

Includes: 0.050" thru 3/8".

Note: Lifetime warranty.



Combination Wrench Set - Metric (10 pieces)*

Part Number - 322190

Includes: 10mm thru 19mm. 15° offset box end knuckle clearance. Made of heat-treated alloy steel for strength exceeding ANSI specifications.

Note: Lifetime warranty.



Hex Wrench Set - L Type, Metric Ball (9 pieces)*

Part Number - 322114

Includes: 1.5mm thru 10mm. Ball end allows better angle of entry for hard to reach areas. Chrome vanadium steel with black oxide finish.

Note: Lifetime warranty.



Angle Wrench Set (6 pieces)*

Part Number - 322262

Includes: 5/8", 11/16", 3/4", 7/8", 15/16", 1".

Note: Lifetime warranty.



1/2" Drive Socket Set (16 pieces)*

Part Number - 322120

Includes: Ratchet, Drive Extension 5", 12 Point Sockets 7/16" thru 1-1/4".

Note: Lifetime warranty.



Pry Bar Set (2 pieces)*

Part Number - 322115

Includes: 6" and 18". Heat treated alloy steel. Bi-mold rubberized comfort grip.

Note: Lifetime warranty.

*Included in Tote Tool Kit (P.N. 322999) and Backpack Tool Kit (P.N. 322996)



Roll Pin Punch Set (8 pieces)*

Part Number - 322210
Includes: 1/16" thru 5/16".
Note: Lifetime warranty.



Punch and Chisel Set (8 pieces)*

Part Number - 322220
Includes: 1/8" Pin Punch, 3/16" Pin Punch, 1/4" Pin Punch, Taper Punch, 3/8" Center Punch, 5/16" Cold Chisel, 1/2" Cold Chisel, 3/4" Cold Chisel.
Note: Lifetime warranty.



Ball Peen Hammer*

Part Number - 322139
Note: Lifetime warranty.



Tape Measure*

Part Number - 322369

- 8m/26' tape measure
- SAE and metric markings
- Automatic blade lock for easy use
- Magnetic hook
- Push button retrieval – quick, one finger operation
- 1-year warranty



Locking Pliers - 7"*

Part Number - 322119
Note: Lifetime warranty.



Locking Pliers - 10"*

Part Number - 322118
Note: Lifetime warranty.



Snap Ring Pliers

Part Number - 322241
Note: Lifetime warranty.



Adjustable Wrench - 6"*

Part Number - 322137
Note: Lifetime warranty.



Adjustable Wrench - 10"*

Part Number - 322138
Note: Lifetime warranty.



3/8" Torque Wrench

Part Number - 322240
Interchangeable head. Adjustable torque wrench body. 150 lb. pressure.
Note: Lifetime warranty (excludes calibration).



Wire Stripper*

Part Number - 322209
Note: Lifetime warranty.



Pick Set (4 pieces)*

Part Number - 322245
Includes: 45°, Straight, 90°, Awl.
Note: Lifetime warranty.



Screw Starter - Phillips*

Part Number - 322219
Note: 90-day warranty.



Screw Starter - Flathead*

Part Number - 322221
Note: 90-day warranty.



Inspection Mirror*

Part Number - 322222
Stainless steel shaft pick up tool. Shaft telescopes from 6 1/2" to 33".
Note: 90-day warranty.



Pick-Up Tool - Magnetic*

Part Number - 322223
Stainless steel shaft pick up tool. Shaft telescopes from 6 1/2" to 33". 5 lb. magnetic power for easy picking of heavy parts.
Note: 90-day warranty.

*Included in Tote Tool Kit (P.N. 322999) and Backpack Tool Kit (P.N. 322996)

Crown Branded Tool Program



Tote Tool Bag

Part Number - 322224

Note: 1-year warranty.

Note: See next page for personal hand trucks used to carry tool bag.



Crown Technician Backpack

Part Number - 322231

- Made from tear-resistant fabric
- Thermoplastic rubber bottom
- Nylon straps
- 55 lb. loading capacity



Slide Rail Socket Holders*

Part Number - 322225

Note: 90-day warranty.



LED Flashlight

Part Number - 322304

- Pen Light
- Metal clip included



40" Crown Top Tool Box

Part Number - 322229

40" x 20" x 19⁷/₁₆" (W x D x H)

40" Crown Roll Cabinet

Part Number - 322230

40" x 20" x 38¹/₂" (W x D x H)

Eleven drawers provide nearly 25,000 cubic inches of storage space.

- Double ball bearing slides on roll cabinet bottom drawer provides 250 pound capacity
- Lock and roll drawers
- Non-slip drawer
- Gas-assisted lifts on the top chest
- Swivel casters are lockable
- Double wall construction
- Powder coat paint provides scratch resistance for lifetime durability
- Anti-theft locks on both chest and roll cabinet for maximum security

LIFETIME WARRANTY



Counter Stool

Part Number - 322300

- Stool height is 30"
- Stool provides the look of patent leather and is great for the parts counter.

WARNING: Reproductive Harm - www.P65Warnings.ca.gov



Mini Tool Box

Part Number - 322227

- The Crown three drawer micro tool box measures 8 1/2" x 4 1/2" x 4 1/2"
- Black gloss paint with aluminum trim
- Perfect for storing small parts or office supplies

Note: Lifetime warranty.



Counter Stool With Back

Part Number - 322305

- Stool height is 30"
- Stool provides the look of patent leather and is great for the parts counter.

WARNING: Reproductive Harm - www.P65Warnings.ca.gov

4" Stainless Steel Magnetic Tray

Part Number - 322302

- Strong holding magnetic tray to secure nuts, bolts and other small parts & fasteners
- 3" PVC coated magnet helps prevent scratching



322303

9³/₈" x 5³/₈" Stainless Steel Magnetic Tray

Part Number - 322303

- Strong holding magnetic tray to secure nuts, bolts and other small parts & fasteners
- Two 3" PVC coated magnets help prevent scratching



Personal Hand Truck

Part Number - 322300-001

150 lb. load capacity. Opens and closes in seconds. Extends to 39" tall. Compacts to 25" tall and 2.5" thick. 15" wide aluminum base plate. 5" rubber wheels. No assembly required. Weight: 7.2 lbs.



Personal Hand Truck

Part Number - 322300-002

200 lb. load capacity. Opens and closes in seconds. Extends to 39" tall. Compacts to 28.5" tall and 2.5" thick. Extra wide 19.25" aluminum base plate. Rugged 22mm steel frame. 7" rubber wheels. No assembly required. Weight: 10.5 lbs.



Portable Vacuum - 1 Gallon

Part Number - 340111

Cord Length: 8 feet. Voltage 12V DC. Crevice nozzle is great for tight spaces. Gulper nozzle is great for large surfaces. Over 20 ft of reach. Plug 12V power cord right into your car.



Ramp

Part Number - 340094-005

20" L x 7.25" W x 1" H. Ramp raises Stockpicker power unit skirt high enough for hydraulic jack to fit under the skirt. Truck should then be properly blocked and secured.



Mast Lubrication Tool Kit

Part Number - 363163

Helps users grease hard-to-reach areas on mast channels. The 6-12 ft pro-pole provides an extension for the chip brush to grease desired areas. Kit includes: Pro-Pole, Brush Holder, and 3" Straight Edge Chip Brush.

Replacement Brush: P.N. 363163-003



Bahco F-Clamp

Part Number - 320076

One fixed and one sliding bracket fitted to a galvanized profiled steel rail along with a plastic covered, ball-swivel foot for easy clamping of odd shapes. 16" overall length. 5" throat depth. 1200 lb. capacity.



360044

Strap and Hook

Tuflex polyester SSEN60 x 1'6" round sling with hook floating on the body.

Part No.	Description
360044	5300 lb Capacity Battery Cell Extractor Strap w/Hook
360044-001	3000 lb Capacity Battery Cell Extractor Strap w/Compact Hook



Weldex 113 Plier

Part Number - 306442

Designed for a safe and easy removal of contacts from SB or SBX connectors. Works on either 175 or 350; simply place the thin blade over the spring and press while pulling the cable or contact.



Hose Pinching Pliers

Part Number - 360041

Used to close off oil or coolant lines to prevent fluid loss during repairs. Used on C5 trucks.



IMAGE NOT AVAILABLE

Rivet Nut Tool Set

Part Number - 320080

21" rivet nut tool. Foldable, 2-in-1 design for both rivets and nuts. Includes 9 interchangeable mandrels (M4, M5, M6, M8, M10, M12, 10-24, 1/4-20 and 5/16-18), 5 rivet heads (3.2mm, 4mm, 4.8mm, 6mm and 6.4mm), and 5 rivet nuts in each size.



Handle and Gate Spanner Tool

Part Number - 104712

For installation and removal of torsion springs on control handles and platform gates. Used on Pallet trucks, heavy-duty Walkies, Stockpickers, and Tow Tractors. Replacement pins: 061011-013



Spanner Wrench

Part Number - 104836

For removal, installation and adjustment of Pallet Truck lift cylinder. Used on PW, PE, PC and PR.



Shore A Durometer

Part Number - 390223

Measures wheel and tire Shore A hardness. Test range: 0-100 HA.



Digital Calipers

Part Number - 320040-001

Capacity 0-6". Rugged stainless steel body and jaws. 4-way measurement: inside, outside, depth and step. LCD display. Powered by one silver oxide battery 1.55V, type SR44. Suitable for machinists and toolmakers.

⚠️WARNING: Cancer and reproductive harm - www.P65Warnings.ca.gov



Fork Wear Calipers

Part Number - 107330

Used to gauge minimum fork thickness and maximum bore size.



Chain Wear Scale

Part Number - 106440

Used to check leaf and roller chain wear used for lift and steering functions.



Chain Wear Gauge

Part Number - 306440

Measures chain from 3/8" up to 3" pitch chain. Measures wear in % increments. Allows user to track wear at each inspection. Limits visual errors. Easy to follow instructions included.



Feeler Gauge Set

Part Number - 360059

Used to measure gap widths and adjust governor gap. Includes (25) 1/2" x 3" blades in sizes .0015" plus .002" to 0.25" in .001" increments.

Hydraulic Forklift Jack with Two Stands

Part Number - 340580
 8800 lb capacity. One year warranty.
 Spring loaded lowering knob for safety.

(Jack - Only)

Part Number - 340582

Seal Kit: P.N. 300080-001
 Includes 2 each index # 8, 12, 17 & 41 and
 1 each # 24, 32, 33, 42, 71 & 72

Pump Assembly: P.N. 300080-100-01
 Index # 100A
 Includes index # 9-27, 30-48, 70-74 & 76

Piston Assembly: P.N. 300080-101-01
 Index # 101A
 Includes index # 30-34, 71 & 72

Capacity Label & Decal Kit: P.N. 300080-100 (also for 300083)



Forklift Stands (two)

Part Number - 340581

7 ton capacity per set of two.

Replacements:

P.N. 300081-001,
 pin with lanyard chain;
 P.N. 300081-002, capacity stickers



Replacement Part Reference for Part Numbers 300083/340582 & 300084/340584

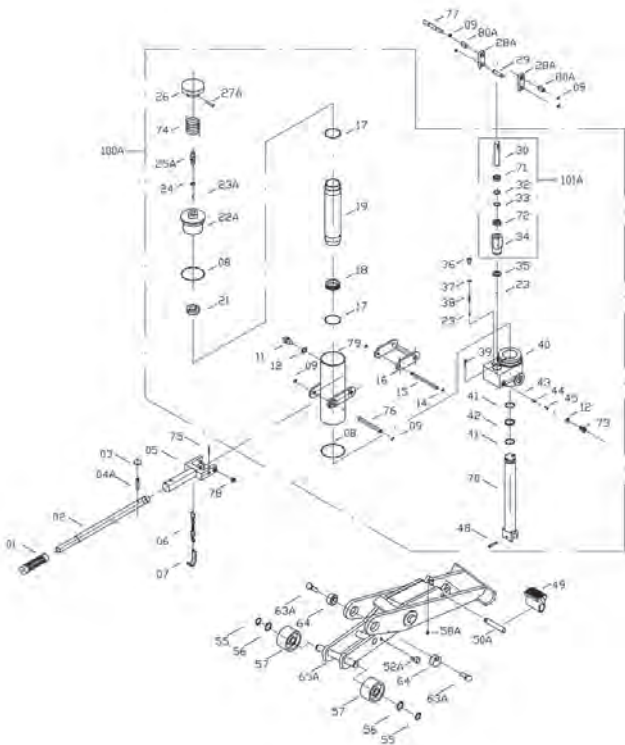

Hydraulic Forklift (Jack only)

Part Number - 340584

14,000 lb capacity
Note: 1-year warranty

Seal Kit: P.N. 300080-001
 Includes 2 each index # 8, 12, 17 & 41 and
 1 each # 24, 32, 33, 42, 71 & 72

Capacity Label: P.N. 300080-104 (also for 300084)



Hydraulic Forklift Jack Replacement Parts

Part Number	Description	Chart Ref. No.	Used On			
			300083	300084	340582	340584
300080-103	Handle & grip	1 & 2	x		x	
300080-004-01	Pin	4A			x	
300080-005	Handle base	5	x		x	
300080-007	Chain & hook	6 & 7	x		x	
300084-007	Chain & hook	6 & 7		x		x
300080-009	Retaining ring	9	x	x	x	x
300084-014	Retaining ring	14	x		x	
300080-015	Pin	15	x		x	
300080-016	Handle frame	16	x		x	
300080-018	Port ring	18	x	x	x	x
300080-023-01	Chrome ball	23A			x	
300080-025-01	Release rod	25A			x	
300080-026	Release knob	26	x	x	x	x
300080-027-01	Roll pin	27A			x	
300080-028-01	Link	28A	x	x	x	x
300080-029	Pin	29	x	x	x	x
300080-030	Plunger	30	x	x	x	x
300080-035	Copper washer	35	x	x	x	x
300080-048	Pin	48	x	x	x	x
300080-049	Saddle	49	x	x	x	x
300080-050-01	Saddle pin	50A	x	x	x	x
300080-052-01	Screw	52A			x	
300080-055	Snap ring	55	x	x	x	x
300080-056	Washer	56	x	x	x	x
300080-057	Wheel	57	x	x	x	x
300080-058-01	Set screw	58A			x	
300080-063-01	Screw	63A	x	x	x	x
300080-064	Trunnion	64	x	x	x	x
300080-065-01	Frame assembly	65A			x	
300084-074	Spring	74	x	x	x	x
300080-076	Pin	76	x		x	
300080-077	Pin	77	x		x	
300080-080-01	Bushing	80A			x	

Hydraulic Jack Seal Kit

Part Number - 341225-001
 Seal kit for Hydraulic Jack P.N. 340580.

NOT for use with Hydraulic Forklift Jack
 P.N. 300080/340582 and P.N. 300084/340584
 listed above.

WARNING: Cancer and reproductive harm - www.P65Warnings.ca.gov



Tool Retractor

Part Number

300114

Capacity 1.76-4.4 lbs. (0.8-2.0kg)
 Extended rope length - 5.5 ft.





Axle Remover

Part Number - 090705

For single or dual load wheel axle removal on PE, PC, PR, PW trucks. One piece tool.

Replacement rods/set of 2 - P.N. 320066

⚠WARNING: Cancer and reproductive harm - www.P65Warnings.ca.gov



Quick Change Load Wheel Installation Tool

Part Number - 150192 (for 2.88" load wheel)

Part Number - 150193 (for 4.12" load wheel)

Used to install quick change load wheels on Reach trucks.



Roll Pin Insertion and Extraction Tool

Part Number - 110567

Removal and installation of load wheel axle roll pin. Used on Stockpickers and RR/RD 3000 and 5000 Series.

⚠WARNING: Cancer and reproductive harm - www.P65Warnings.ca.gov



Tire Adapter

Part Number - 134169

Used to press drive tire on RR/RD 5000 Series trucks. See PIB 05-08-02.

⚠WARNING: Cancer and reproductive harm - www.P65Warnings.ca.gov

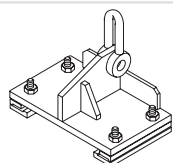

Auxiliary Mast Lifting Tool

Part Number - 110571

Facilitates handling auxiliary mast. Used on TS. Refer to platform maintenance of service manual, (section 9.0). One piece tool.



Steer Bearing Cup Removal Kit

Part Number - 133884

Used to push cup-holder off of undercarriage dowel pins after bolt removal. Used on all RR5, RM6, RM1, and SP4 models.

Individual Items: Push-Off Bolt (P.N. 060133)

⚠WARNING: Cancer and reproductive harm - www.P65Warnings.ca.gov



Gage Shim Assembly

Part Number - 125535

Gage used to shim Wave masts. Used with Part Numbers 125539 and 133403. See maintenance section for where used.



Mast Tool

Part Number - 810705

ESR4000 Mast Tool used to calculate the required roller diameter.



Gage Shim Assembly

Part Number - 125539

Gage used to shim Wave masts. Used with Part Numbers 125535 and 133403. See maintenance section for where used.



Shield / Screen Installation Tool - Tapered Tip

Part Number - 340020-001

Used to install shields on RR/RD 5000 series, Stockpicker and Turret trucks



Gage Shim Assembly

Part Number - 133403

Gage used to shim Wave masts. Used with Part Numbers 125535 and 125539. See maintenance section for where used.



Shield / Screen Installation Tool - Complete Kit

Part Number - 340020-002

Used to install shields on RR/RD 5000 series, Stockpicker and Turret trucks.



Spanner Tool

Part Number - 100455

For removal, installation and torquing the axle locknuts. Used on RC, SC, Reach, TSP, TS and SP 3000 Series.



Hole Cutting Tool Arbor

Shank with Pilot Pin - Hougén

Part Number - MSC98380876

Minimum tool diameter compatibility: 1³/₁₆".
Maximum tool compatibility: 1¹/₂".
Shank diameter: 1/2". No. of flats: 3. Material: Steel.
Weldon flat: No.

Straight shanks are used for general purpose applications. The shank is smaller than the drill bit diameter. They are used with portable drills and drill presses on ferrous and nonferrous materials.



Tool Assembly

Part Number - 132501

Used for installation of load wheels on stockpickers, WR and reach trucks with an axle diameter of 1.375. This tool aligns the shims and wheels to make it easier to get the axles in.



Tool Assembly

Part Number - 132502

Used for installation of load wheels on stockpickers, WR and reach trucks with an axle diameter of .975. This tool aligns the shims and wheels to make it easier to get the axles in.



Primary Lift Cylinder Retention Tool

Part Number - 164857

Used on RM 6000 to restrain the primary lift cylinder while raising the 2nd & 3rd mast stages. Used in the removal and installation of the reach assembly.



3rd Stage Mast Locking Bar Tool

Part Number - 150796

Used to move mast stops on RM/RMD series mono masts.

Mechanical Tools



Bracket Lifting Assembly

Part Number - 149650-001

Bracket bolts to the top of the mast and is used to assist in laying over trucks for shipment. Retains the 2nd & 3rd mast stages from extending while horizontal.

Bracket requires (6) .5" screws (PN 060019-081)



Timkin Socket Tools

Part Number - 100253-XXX

For removal, installation and torquing of locknuts. Adapts to 1/2" drive socket.

Individual Items:

- 100253-001 - Fits locknut 060043-004
- 100253-002 - Fits locknut 060043-002
- 100253-003 - Fits locknut 060043-003
- 100253-004 - Fits locknut 060043-001
- 100253-005 - Fits locknut 060043-005
- 100253-006 - Fits locknut 060043-006
- 100253-007 - Fits locknut 060043-010
- 100253-008 - Fits locknut 060043-008
- 100253-009 - Fits locknut 135496



Hole Cutter

Annular Cutters - Hougén

Part Number - MSC98382922

Diameter: 1 5/16". Cutting depth: 1/2".

Precision ground to produce burr-free holes up to 1/2" deep. Ideal for electrical, piping, conduit, sheet metal & HVAC applications. High-speed steel provides good wear resistance and can be used in general purpose applications for both ferrous and nonferrous materials.



Borescope

Part Number - 360071

Helps technicians view difficult to see places when troubleshooting. Used to view inside engine cylinders, radiators, transmissions, and drive units as well as many other uses. Dual-image lenses for straight ahead and 90-degree angle viewing. Digital images are stored to internal 32GB memory. Video recording and playback can be viewed on the 5" diagonal screen. Powered by a rechargeable Lithium battery and equipped with a USB port to transfer data.



Torx Bits

Part Number Specifications

360043	T25
360043-002	T15
360043-003	T20
360043-004	T20 Plus

Used to service C-5 Fuel System Electronic Pressure Regulator and Carburetor.



1/4" Drive Metric Hex Bit Sockets

Part Number Description

360043-007	1/4" Drive 2mm Hex Bit
360043-008	1/4" Drive 2.5mm Hex Bit
360043-009	1/4" Drive 3mm Hex Bit
360043-010	1/4" Drive 4mm Hex Bit
360043-011	1/4" Drive 5mm Hex Bit

Used for servicing V-Force Lithium Ion Batteries with 1/4" Drive Socket Set P.N. 322000.



Lincoln Grease Fitting Cleaner

Part Number - MSC55374169

Steel. 5852 Coupler, High Pressure Hose, Piston, Safety Shield, Steel Drive Cylinder

▲ **WARNING:** Cancer and reproductive harm - www.P65Warnings.ca.gov



Nut Adjusting Tool

Part Number - 104958

For removal, installation and torquing of locknuts on the center pivot assembly of reach assemblies. Used on Reach trucks.

▲ **WARNING:** Cancer and reproductive harm - www.P65Warnings.ca.gov



Swaging Tool

Part Number - 107416

Crimping stop ferrule on wire rope. Used on Turret and SP 3400 height sensors.



Hand Swage

Part Number - 090526

Properly crimp compression fittings when repairing or replacing cable. Usage: SP Steering cable, Pallet clamp cable and TS, TSP hose take-up cable. Crimps both shielded and unshielded aircraft control cable. One piece tool, manufacturer's instructions included.



Close Quarter Prybar

Part Number - 360058

Used to remove RC 5500 & SC 5200 drive unit sub-assemblies from mount plates without damaging the housing.



Air Solvent Gun

Part Number - 065174-001

Use with any solvent.



Molding Insertion Tool

Part Number - 360072

To ease installation of the wedge locking strip for two-piece rubber molding. 4" contoured handle and 4" metal shank. Includes two double ended tips to fit most applications. Tip swivels 90° in either direction. Used for safety glass replacements on Stockpickers after 10/86 and Turrets. Reference TSB 227.



**Mobil Crimp 4-20
Digital Dial Control**

Part Number Vendor Number

320040-420	7480-0051
------------	-----------

Thermoplastic or Rubber Hose. This lightweight, versatile crimping tool is powerful enough to crimp up to 1-1/4" 4 spiral-wire hose. Weighing approximately 57 pounds, this field crimping tool combines the latest crimping technology with old-fashioned toughness and durability. Unit supplied with digital calipers, instructional CD, and manuals.

Note: See below for Die Selection Chart.

Replacement knob: P.N. 320040-420-07

▲ **WARNING:** Cancer and reproductive harm - www.P65Warnings.ca.gov



320040-420-01



320040-420-02



320040-420-03



320040-420-05



320040-420-06

Mobil Crimp 4-20 Power Sources

Power Sources	Description	(PSI) Rating	Weight (lb)	Vendor Number	Part Number
Hand Pump	No power source needed. Economical, convenient and portable for use anywhere. Make factory-quality assemblies in the field to minimize downtime.	10,000	25.6	7481-0006	320040-420-01
Shop Air Pump	Works off standard shop air (90 psi). Economical, convenient and versatile for use wherever 90 psi compressed air is available.	10,000	10	7481-0002	320040-420-02
12 Volt DC Pump 1/4 HP	Mobile operation, runs on standard 12 volt car/truck battery or a 12 Volt portable battery pack. Ideal for tough jobs in the field.	10,000	20.5	7481-0037	320040-420-03
115 Volt AC Pump 1/2 HP	Medium speed. Economical. Recommended for a stationary or mobile application.	10,000	32	7481-0034	320040-420-05
115 Volt AC Pump 1-1/2 HP	High speed. Recommended for stationary applications only.	10,000	108	7481-0035	320040-420-06

▲ **WARNING:** Cancer and reproductive harm - www.P65Warnings.ca.gov

▲ **Mobile Crimp 4-20 Die Selection Chart**

Part Number	Die Set	M3K, M2T, G1(C1T) & G2(C2AT) Gates	
		Rubber Hose Size	3160, 3360, 30CT Synflex Hose Size
320040-422	MC22	3/8"	1/2"
320040-431	MC31	1/4"	5/16" and 3/8"
320040-423	MC33	1/2"	5/8"
320040-424	MC34	5/8"	
320040-435	MC35	3/4"	
320040-437	MC37	1"	
320040-425	MC45		1/4" and 3/16"

Note: Check crimp diameter and length after each use.

▲ **WARNING:** Cancer and reproductive harm - www.P65Warnings.ca.gov

▼ **PC707 Die Selection Chart**

Part Number	Die Set	M3K, M2T, G1(C1T) & G2(C2AT) Gates	
		Rubber Hose Size	3160, 3360, 30CT Synflex Hose Size
320040-731	731	1/4"	5/16" and 3/8"
320040-732	732	3/8"	1/2"
320040-733	733	1/2"	5/8"
320040-734	734	5/8"	
320040-735	735	3/4"	
320040-737	737	1"	
320040-745	745		1/4" and 3/16"

Note: Check crimp diameter and length after each use.

▲ **WARNING:** Cancer and reproductive harm - www.P65Warnings.ca.gov



**Power Crimp PC707
Crimper Only**

Part Number Vendor Number

320040-707-01	7480-0043
---------------	-----------

Thermoplastic or Rubber Hose. PC707 is the most precise, yet simplest crimping tool made. It has electronic digital readout to indicate gauge settings. Just push a button and it makes factory-quality hose assemblies in a few seconds. Wired for 115 volts. Includes die backup ring and a notched cone. Weighs 188 lbs. Unit supplied with digital calipers, instructional CD, and manuals.

Note: See above right for Die Selection Chart.

▲ **WARNING:** Cancer and reproductive harm - www.P65Warnings.ca.gov



**Power Crimp PC707
Power Source**

Part Number Vendor Number

320040-707-02	7481-0023
---------------	-----------

Pressure Rating Weight (lb)

4,900 psi	70
-----------	----

The flow of two fixed displacement pumps are combined to deliver a high volume of oil at low pressure for fast transversion.

▲ **WARNING:** Cancer and reproductive harm - www.P65Warnings.ca.gov



Thermoplastic Hose Power Swaging Tool

Part Number	Vendor Number
108160	4530-009S0



Hose Cutter

Part Number	Vendor Number
108159	4523-04006

Note: For use on 1/8" to 1/2" hose

Replacement Blade

Part Number	Vendor Number
320032	4523-04003

Note: For use with P.N. 108159



Thermoplastic Hose Hand Swaging Tool

Part Number	Vendor Number
108161	4530-01002



Pusher and Coupling Carrying Case

Part Number	Vendor Number
320021	45J0-0433

Note: Only trays included.



Pusher

Part Number	Vendor Number	Part Number	Vendor Number
320017	4599-FP002	108150	4599-MP008
108137	4599-FP005	108151	4599-MP009
108138	4599-FP006	108152	4599-MP011
108139	4599-FP008	320018	4599-MP037
320025	4599-FP010	320026	4599-MP045
108141	4599-FP012	320019	4599-MP046
108142	4599-FP013	320020	4599-SP031
108143	4599-FP015	108153	4599-TP204
320031	4599-FP040	108154	4599-TP205
108146	4599-MP002	108155	4599-TP206
108147	4599-MP004	108157	4599-TP308
108148	4599-MP005	108158	4599-TP310
108149	4599-MP007	320034	4599-TP312

Note: Used with Hand and Power Swaging Tool, 108160 and 108161.



Swager and Die Carrying Case

Part Number	Vendor Number
108163	45J0-04300

Note: Tools & Dies not included.



Cylinder Groove Filler Strip

Part Number - 090779

To aid in removal of pistons by minimizing packing damage during removal. Used on all trucks with piston type (double acting) cylinders utilizing a wire retainer to secure the end cap such as tilt, reach and sideshift cylinders. See TSB 163. One piece (16" long).



Die

Part Number	Vendor Number	Part Number	Vendor Number
108130	4540-303	320049	4540-A0800
108131	4540-304	108135	4540-H06
108132	4540-305	108136	4540-H08
108133	4540-306	320015	4540-J06N0
108134	4540-308	320016	4540-35340

Note: Used with Hand and Power Swaging Tool, 108160 and 108161.



Poly Pack Seal Tools

Part Number - 091240-001 thru 091240-020

Aids in installing seals in poly pak or rod packing cylinders. One tool per dash number. i.e. 091240-004 represents one specific size tool. See TSB 155 and TSB193.

WARNING: Cancer - www.P65Warnings.ca.gov



Cylinder Cap Tool

Part Number - 106438

For removal and installation of cylinder caps used on turret trucks.

WARNING: Cancer - www.P65Warnings.ca.gov



Insertion Depth Marker

Part Number	Vendor Number
320033	45J0-04603



Spanner Wrench

Part Number - 104836
For removal, installation and adjustment of Pallet Truck lift cylinder. Used on PW, PE, PC and PR.



Spanner Wrench

Part Number - 360037-5698
For use on SR5000, ESR5200 Griptech fork cylinders, and TSP7000 KOOL fork cylinders.

▲ **WARNING:** Cancer and reproductive harm - www.P65Warnings.ca.gov



Socket Weldment

Part Number - 143065
Cylinder cap tool for removal and installation of cylinder cap (133084) used on TSP 6000.

▲ **WARNING:** Cancer and reproductive harm - www.P65Warnings.ca.gov



Cap Socket

Part Number - 117318
For removing cap on main lift cylinder on TSTN, TSPTN.

▲ **WARNING:** Cancer and reproductive harm - www.P65Warnings.ca.gov

Cylinder Cap Sockets

Part No.	Truck Model	Cylinder	Tool Kit
149322	RR/RD, FC/C5	Primary	149557
149323	RR/RD, FC/C5	Secondary	149557
149322	RM		149558
149495	SC/RC	Primary	149559
149494	SC/RC	Secondary	149559
150063	SP	Primary	150081
149323	SP	Secondary	150081
150063	SH/SHR	Primary	150082
150065	SH/SHR	Secondary	150082
150064	W/WB/WR		150083
149323	W/WB/WR		150083
149322	W/WB/WR		150083
150063	W/WB/WR		150083
150065	W/WB/WR		150083
150456	TSP 6000/7000 TT	Primary	150469
150696	TSP 6000/7000 TT	Primary	150469
150455	TSP 6000/7000 TF		150470
150457	TSP 6000/7000 TN		150471
150458	TS, TN, TF		N/A
149323	TSP 6000/7000 AUX		150472
150456	TS, TSP, TN		150473
150063	TS, TSP, TF		150474
150696	TSP AUX		150475



Cylinder Packing Tool

Part Number	Used on Cylinder Cap
804714-001	804751
804714-003	804749
804714-005	810639



Seal and Piston Tool Kit

Part Number - 127576
Used on SC4000 & SC5000 Series steer cylinder. See maintenance section, M6.0. Kit instructions PF16486

Individual Items:

Seal Loading Tool (P.N. 127521),
Piston Loading Tool (P.N. 127522)

▲ **WARNING:** Cancer - www.P65Warnings.ca.gov



Cylinder Seal Tool Kit for Stockpickers

Part Number - 150081
includes 150063 cap socket, 150066 polypack driver, 149323 cap socket, 150067 polypack driver, 091240-005 poly pack sleeve and 091240-009 poly pack sleeve.



Test Plug Assembly (7/8"-14)

Part Number - 092177
Used to isolate faulty hydraulic component valves. All Crown lift trucks using 7/8"-14 thread hydraulic external component valves, except relief valves. One piece plug with sealing rings.



Test Plug Assembly (3/4"-16)

Part Number - 093391
Used to isolate faulty hydraulic component valves. Utilizing 3/4"-16 thread hydraulic external component valves, except relief valves. One piece plug with sealing rings.



Anti-Splash Funnel with Filter

Part Number - 126098
144 oz. (4 L.) capacity funnel with anti-splash ring and removable mesh 100 grit filter. Ring eliminates spilling of liquid caused by swirling. Chemically resistant and durable. Hang-up tab on rim. 9" top diameter, 1-1/8" spout outside diameter.

▲ **WARNING:** Cancer and reproductive harm - www.P65Warnings.ca.gov



No Drip Funnel

Part Number - 322232
Small and large adapter.
Fits 1L, 2L, 4.4L & 5L bottles.



18" Long Reach Poly Funnel

Part Number - 300099
The 18" funnel works great for filling transmission and other fluid. This funnel can hold up to one quart of fluid and has 4 3/4" top opening and 1/2" bottom spout opening.



16" Long Reach Poly Funnel

Part Number - 300105
24 oz. capacity funnel with hanging tab. Designed to cradle the bottle neck. 4-3/4" x 5-3/4" top opening. 1/2" bottom spout opening.

▲ **WARNING:** Cancer and reproductive harm - www.P65Warnings.ca.gov

Hydraulic Tools



Oil Test Kit

Part Number - 363515

Tests hydraulic and motor oil. Mail oil samples in for content test results. Comes with container for oil, mailing container and labels.

▼ Test Kit Accessories Suction Pump

Part Number - 363515-001



Tubing, 100 Feet

Part Number - 363515-002

⚠️ **WARNING:** Cancer and reproductive harm - www.P65Warnings.ca.gov



Accumulator Charging Tool

Part Number - 103623-004

For charging and testing bladder and diaphragm type nitrogen charged accumulators. Accumulators used on Turrets and Stockpickers. Includes: gauge, valve, hose, adapter for nitrogen tank, carrying case and manufacturer's instructions.

Individual Items:

- Upper Seal (P.N. 300092)
- Lower Seal (P.N. 300093)
- Hose with Fittings - (P.N. 121422)
- Manual Bleed Valve - (P.N. 300133)
- Adapter A9 (FPK to VG8) - (P.N. 300138)



⚠️ **WARNING:** Cancer and reproductive harm - www.P65Warnings.ca.gov



Hydraulic Pressure Gauge

Part Number - 104812

Used to check hydraulic systems pressure on truck. Used on all Crown lift trucks except tow tractors. Includes: gauge, hose (36") and fitting (1/2" N.P.T.) for TS/TSP model trucks.

All other models of trucks require fitting and connector listed below, not included with gauge.
Female fitting (P.N. 123321)
Connector (P.N. 064005-003)
High pressure gauge (P.N. 304812-001)

⚠️ **WARNING:** Cancer and reproductive harm - www.P65Warnings.ca.gov



Pressure Gauge

Part Number - 300098

- 4000 PSI single gauge
- 0 to 4000 PSI
- Quick Disconnect (P.N. 123321)
- Used on RST50 & C5

⚠️ **WARNING:** Cancer - www.P65Warnings.ca.gov



Coupler

Part Number - 123321

- Used on 300098 and 104812
- Works with nipple part numbers 123887 & 127214



123887



127214

⚠️ **WARNING:** Cancer and reproductive harm - www.P65Warnings.ca.gov



1/2" Thin Wall Socket

Part Number - 104884

For removal and installation of relief valve seat on J.S. Barnes pump and motor assemblies. Used on PW, PE, PC, GPW, SP 3000 Series.



1/4"-12 Point Socket

Part Number - 104885

For disassembly and reassembly of J.S. Barnes pumps and Charlyn torque generators.



Hose Pulling Tool

Part Number - 106465-001 and 106465-002

To couple replacement hose to existing hose for ease of replacement.

Kit instructions - PF8075.

3/4"-16 fitting use P.N. 106465-001

9/16"-18 fitting use P.N. 106465-002



Spanner Tool

Part Number - 108641

Adjust hose take-up used on TS and TSP.



Lifting Bracket

Part Number - 151332

Used on RM6000 to lift out secondary lift cylinder ram out of the cylinder without removing the secondary cylinder assembly.



Velocity Fuse Tool

Part Number - 126400

For removal of velocity fuse in left hand cylinder. Used on RR/RD5000/5200/5700 standard & S class trucks.



Piston Retainer Tool

Part Number - 816908

Used on PTH 50 Hydraulic Unit (P.N. 816814-001) to keep spring down.



Pin Tool

Part Number - 163409

Used to prevent the second stage mast from moving during disassembly and reassembling the mast sections. Makes it easier to remove/install the third stage. Used on TSP6000/6500/7000 with TT mast only.



Pass-Thru Ratchet Set (27 pieces)

Part Number - 360048

1/4" drive, pass-through, 6 point. SAE sockets 5/32-9/16". Metric sockets 3.5-13mm. Includes 3" and 6" extensions. Used on SC5700, SC6200 and FC5700.

Drive Tools



Stud Alignment Tool

Part Number - 125097
Used on RR and RR 3000 Series trucks, SP 3000 Series and TSP. Used to install Drive Unit Steer Bearing and Stud Kit (P.N. 125096). Kit Instructions - PF6947 and PF6948

Individual Items:

Alignment Tool (P.N. 125093),
Drill Bushing (P.N. 125098),
Reamer (P.N. 125101)



Gauge Pivot Stud

Part Number - 128463
Used to shim drive units on RR/RD 3000 and 5000 Series, SP 3000 Series, TS and TSP. See kit instructions PF16487 & PF16762.



Drive Wheel Hub Puller

Part Number - 141356
Used to remove locking nut to replace drive axle seal. Used on RC 5500 & SC 5200. See kit instructions PF16825.



Special Roll Tap

Part Number - 126105
Used to tap dowel pins on RR 5000 Series drive unit. See TSB 378.



Drive Wheel Hub Puller

Part Number - 340079
Used to remove locking nut to replace drive axle seal. Improved, deluxe model. Makes it easier to remove hub and takes a lot less time than using 141356. Used on RC 5500 & SC 5200.



Spanner Tool

Part Number - 145194
Used to remove the threaded adjuster plate from the back side of the RC 5500 & SC 5200 drive unit. It is required for drive unit disassembly.



Driver Nut Assembly

Part Number - 141357
Used with gear puller to remove wheel hub. Used on RC 5500 & SC 5200. See kit instructions PF16825.



Drive Unit Mount Tool

Part Number - 145509
Used to mount the RC 5500 & SC 5200 drive unit in a vice to hold it in position while working on it.



Seal Installation Tool

Part Number - 091009
Aids in installing 2nd reduction gears inner (and outer) oil seal on pre-3000 SP, Pallet, Tow Tractors and Heavy-Duty Walkies. TSB 152, Kit Instructions PF6445 included with part. Includes: threaded sleeve, threaded body, 2 piece handle, 3 locking bolts, depth gauge.

Accessory Items: Gauge (P.N. 091263)



Brush Retaining Tool

Part Number - 803547-001
Used with Drive Motor (P.N. 803703).

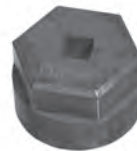

Bearing Cup Tool

Part Number - 130675
Used to rebuild drive unit on FC 4000.



Retaining Ring Pliers

Part Number - 320078
For removal and installation of large retaining rings. Used on pre-3000 series Stockpickers, Pallet Trucks, Tow Tractors, and heavy-duty Walkies. Tip replacement set P.N. 320079.



Drive Coupler

Part Number - 131348
For drive motor pinion locknut installation of FC 4000.



Pilot Rods

Part Number - 141316
Used to align RC5500 traction motor. Need quantity of 4.



Drive Unit Removal Tool

Part Number - 340332
Used to remove or install a PE, TR, PR or 3OSP drive unit.



Drive Unit Mount Gauge

Part Number - 126383
Used to shim drive unit on RR 5000. Kit Instructions - PF6998



Steering Adapter Tool

Part Number - 171108
Used to check drive unit alignment. See PIB23-04-02.





Meter Kit (P.N. 100696)

Multimeter Fluke Series 179

Part Number - 121357
 Precise readings of A.C. or D.C. voltage, resistance, low current and frequency. Required for wire guidance systems. Used also for electrical troubleshooting. Includes: 179 Series multimeter, yellow holster, test leads, batteries and instruction manual.

Kits: Meter Kit - (P.N.100696), includes Fluke Meter, Carrying Case, Test Leads, and Thermocouple Probe.



Multimeter Fluke Series 87 Series III True RMS

Part Number - 121359
 Precise readings of A.C. or D.C. voltage, resistance, low current and frequency. Required for wire guidance systems. Used also for electrical troubleshooting. Includes: 87 Series multimeter, yellow holster, test leads, batteries and instruction manual. Includes: Thermocouple Probe.

Accessory Items: Holster (P.N. 121360), Test Lead Assembly (P.N. 321359)



Fluke Meter 3000 Series

Part Number - 321357
 Precise readings of AC or DC voltage, resistance, low current and frequency with this wireless digital multimeter.



Fluke 325 True RMS Clamp Meter

Part Number - 109040
 Rugged, reliable True-RMS clamp meter with DC current and frequency measurements. Measures AC and DC voltages to 600 V. Measured AC and DC current to 400 A. Provides True RMS AC voltage and current for accurate measurements on non-linear signals. Measures frequency to 500 Hz. Measures resistance to 40 kilo-ohms with continuity detection.



Current Clamp

Part Number - 109039
 For accurate measurement of AC or DC up to 1000A current draw on battery without inline shunt connection. Includes instructions.

Multimeter Accessory Items

Used with Part Numbers - 121357 and 121359

Thermocouple Probe

Part Number - 300091
 One piece construction with banana jack. Measurement range: -40 to 500°F (-40 to 260°C) Type K



Shrouded Test Kit

Part Number - 121421
 For use with multimeters that accept shrouded standard diameter, 0.16" (4mm), banana plugs. Manufacturer instructions included. Includes: 2 - #18 AWG (0.75mm²) test leads 48" (1.2m) long, one red, one black. Two insulated alligator clips with banana jacks, 5/16" (7.9 mm) jaw opening. Two spade lugs. One safety-grip spring loaded hook style test clip. One test lead pouch.



Test leads 59" (1.5 m) long; one red, one black (P.N. 301501)

Lead Set (Clip-on)

Part Number - 101490
 For use with digital (VOM) multimeter on printed circuit boards and close areas where standard tips may short out components. Required on wire guidance P.C. boards such as sensor amplifier boards. Includes: 2 leads with jacks and spring loaded probes (1) red and (1) black.



⚠ WARNING: Cancer and reproductive harm - www.P65Warnings.ca.gov

Backprobe Pin Set

Part Number - 320067
 Slides onto test lead, narrowing the point of contact for the test lead to be used in narrow situations or hard to reach areas.



Probe Set

Part Number - 102973



Tool Carry Case

Part Number - 128321



Probe Set

Part Number - 300600
 The EAP Kit is designed for electronic systems in which precision is mandatory. Each probe mirrors a back-pinning probe, a piercing probe, and a pin-tip probe. Probes are repairable if they bend or break.



⚠ WARNING: Cancer - www.P65Warnings.ca.gov



Field Strength Meter

Part Number - 112953
 To check field strength of guide wire. Label on meter with instructions. See TSB 317.

Wave 50 Repair Kit (without Handset)

Part Number - 127674-001

Wave 50 Repair Kit (with Handset)

Part Number - 127674-002

Kit Contents Listed (Right)



Part Number	Description	Qty.
120195	Potentiometer	1
146286	Key Switch w/keys	1
107151-001	Keys	1
120200-001	Raise Switch	1
120200-002	Lower Switch	1
128364-001	Presence Switch	1
128364-002	High Speed Switch	1
120283-001	Top Shim .015	4
120283-002	Top Shim .025	4
120283-003	Top Shim .035	4
120284-001	Bottom Shim .015	4
120284-002	Bottom Shim .025	4
120284-003	Bottom Shim .035	4
120198-001	ED Switch	2
062692	Switch	4
142809	Display	1
123928	ED Contact Kit	1
094362-002	15 Amp Fuse	2
076924-011	40 Amp Fuse	2
084343	Lift Solenoid	2
113772	Fuse Holder	2

Part Number	Description	Qty.
062595-003	Raise/Lower Switch	1
062595-005	Drive/Tow Switch	1
120127	AC Inlet	1
125253	Pin Link	2
125254	Link	4
060009-092	Retaining Ring	8
060009-003	Retaining Ring	4
062536-001	Terminal	24
062536-002	Terminal	24
062594-002	Connector Red	2
062594-003	Connector Black	2
062535-005	Connector	2
069188	Decal	1
118993	Extraction Tool	1
117615	Extraction Tool	1
116858	Terminal	12
127671	Carry Case	1
154158	Handset (Kit 127674-002 only)	1

⚠ **WARNING:** Cancer and reproductive harm - www.P65Warnings.ca.gov

GE Handset

Part Number - 112209

Dial in calibration settings, retrieve service code numbers. Used on FC/FP, FC 4000, RR/RD/RS, RR/RD/RS 3000, SP 3000, SP 3200, RC 3000, SC 4000, EV100LX and GE SX. Includes: Soft side carrying case, interconnecting cord, handset and manufacturer's instructions.

Accessory Items:

Replacement Cord (P.N. 113972)
Replacement Cord for SC 4000 (P.N. 127085)
Handset and Both cords (P.N. 127458)



Extender (Board) Card

Part Number - 090116

Extension between the logic board receptacle and logic board to permit access for making voltage checks. Used on pre 3000 Series Reach trucks.

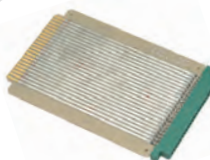

Unimeter Programmer

Part Number - 300034

Program settings on unimeter.



Curtis Calibrator Handset

Part Number - 154158

Used to input calibration settings, monitor inputs and outputs, diagnostic and troubleshooting aid. Used on GPW, Wave, PE 4000, WE/WS 2000/2300, WP 3000, TR 3600, PC 3600 and GPC 2000 Series. See maintenance manual (M4.2) for instructions. Includes four cords: DB-9 male connector, USB AM & mini USB 5 pin connector, 154199 / Molex style and 154200 / phone style (RJ11).



Curtis handset cords for **prior** Model 1311 handset (P.N. 154158):
P.N. 130480 - Molex style
P.N. 130481 - Phone style (RJ11)

Service Terminal Kit

Part Number - 118207

Enables monitoring service condition (malfunction) history. Allows performing calibration procedures without opening electronic boxes. TS, TSP, SP 3000, SP 3200, SP 3400 (not SP 3500). Includes: terminal keyboard with two line liquid crystal displays, detachable cables and connectors, foam filled shock resistance carrying case with instruction and operating guide, "How to Use Your Crown Service Terminal" Kit instructions: PF6703.

Accessory Items: TS/TSP Cable Assembly (P.N. 102226), SP 3000 Series Cable Assembly (P.N. 118845-00S), Case (P.N. 118954), Service Terminal (P.N. 101528-001), Service Terminal Manual (PF10462)



Controller Handset

Part Number - 793548

Handset for Zapi controller. Used on WP 2000 series and ST/SX series. Includes black housing and mounting hardware, white connector and terminals.

Accessory Item:

White Connector (P.N. 803450-019)



Curtis Handset Cord - Molex

Part Number - 125736

Handset cord for 117617 Curtis calibrator (1207).



Diagnostic Tools



▲ Connector Rebuild Kit

Part Number - 320055
For controller handset 793548. Includes black housing and mounting hardware, white connector and terminals.



BMID Battery Monitoring Identification Device

Part Number - 396525-BTM
BMID compatible only with Crown V-Force HFM charger. For more details, see page 8.08.



Coolant/Battery Acid Refractometer

Part Number - 390221
Portable Coolant Refractometer, Coolant/Battery Acid 1.15 to 1.30. Specific Gravity of Battery Acid. Measures the freezing point of coolants and the charge condition of batteries.

▲ **WARNING:** Cancer and reproductive harm - www.P65Warnings.ca.gov



Cell Trac AC Power Cord

Part Number - 390220-SP



Battery Tester

Part Number - 320070
100 amp battery tester. 300 amp extended jaw. Tests: battery load tests, starters & alternators, battery state of charge.



UV LED Flashlight

Part Number - 363200-016

- Bulb Type - UV LED 500
- 2.5 hr. Max Run Time
- Ultraviolet rays emitted reveal leaks when used with Oil-Glo fluorescent dye (see Service Section p. 1.03)

363200-016



UV Flashlight Kit

Part Number - 363200-011

- 20 feet leak detection range
- Kit includes flashlight, three "AAA" batteries, UV-absorbing glasses, belt holster and lanyard
- UV leak detection flashlight works with Oil-Glo fluorescent dye (see Service Section p. 1.03)

363200-011

Steering Tools



Hand Swage

Part Number - 090526
Properly crimp compression fitting when repairing or replacing cable. Usage: SP Steering cable, Pallet clamp cable and TS, TSP hose take-up cable. Crimps both shielded and unshielded aircraft control cable. One piece tool, manufacturer's instructions included.



Steering Wheel Removal Tool

Part Number - 129257
To remove steering wheel on SC 4000/4500/5200 trucks manufactured from September 9, 1999 to present. Kit instructions - PF16549.



Ball Joint Separator

Part Number - 122532
Used to separate steering ball joint connections. Used on FC/FP and FC 4000.



Steer Axle Spanner Socket

Part Number - 146107
Used to remove locknut 060043-009. Used on SC 4000/4500/5200, RC 5500 and TSP 6000 steering assemblies.



Seal and Piston Tool Kit

Part Number - 127576
Used on SC 4000 & SC5000 series steer cylinders. See maintenance section, M6.0. Kit instructions PF16486.

Individual Items:

Seal Loading Tool (P.N. 127521),
Piston Loading Tool (P.N. 127522)

▲ **WARNING:** Cancer - www.P65Warnings.ca.gov



Power Steering Motor Gear Puller

Part Number - 340403
To remove the gear on the power steering motor on PE4500 series trucks equipped with power steering.

Brake Tools



RC Brake Special Nut

Part Number - 114050

For assembly and disassembly of brake actuation spring. Use on RC with disc brakes.



RC Brake Adjustment Threaded Tube

Part Number - 114051

For assembly and disassembly of brake actuation spring. Use on RC with disc brakes.



Riveter Press

Part Number - 114518

Used to replace brake pads on SP 3000 Series and SC & SC 4000 trucks. Used with Brake Pad Rivet Tool (P.N. 112397).



Riveter Base

Part Number - 119343

Used with 114518 on SP 3000 Series. See maintenance section, (M5.0) for instructions.



Brake Pad Rivet Tool

Part Number - 112397

Used to replace brake pads on SP 3000 Series and SC & SC 4000 trucks. Used with Riveter Press (P.N. 114518).



Brake Shoe Setting Gauge

Part Number - 120988

For setting brake shoes prior to installing brake drum. Used on FC/FP. Instructions see Service and Maintenance Manual (section M5.0).



Telescoping Gauge

Part Number - 300089

Used to check power brake wear on RST-50 & C-5 models with power brake option.



Brake Release Tool

Part Number - 127373

Release drive brake. Use on RR 5000 Series trucks, RM/RMD6000/S. See TSB 412. Use with Harness Adapter (P.N. 129694).



Brake Adapter Harness

Part Number - 129694

Use with Brake Release Tool (P.N. 127373) on RR 5000 Series trucks. See TSB 412.



Brake Release Tool

Part Number - 139956-001 / 139956-002

Release drive brake. Use on SC 4500 and RC 5500 series trucks. See kit instructions PF16819.

139956-001 - 24 volt

139956-002 - 36/48 volt



Piston Removal Tool

Part Number - 126431

Used on FC/FP with power disc brakes and FC 4000 Series. Removes piston from service brake.



Brake Pedal Adjustment Kit

Part Number - 138570

Used to adjust brake linkage on RC 3000. Kit instructions: PF16550



Retainer Ring Assembly Tool

Part Number - 132417

Used to disassemble caster and brake assembly on RR 5000S class Series only. Kit instructions: PF16763



Fluid Evacuator/Brake Bleeder, Pneumatic

Part Number - 320068

Use for draining engine oil or transmission fluid directly through the dipstick tubes. Includes brake/clutch bleeding kit. 2.3 gallon reservoir capacity.



Fluid Evacuator, Manual

Part Number - 320069

Automatic shutoff with quick-drain pour-spout, large stable base, and foot stabilizer. 1.7 gallon reservoir capacity.

⚠ **WARNING:** Cancer and reproductive harm - www.P65Warnings.ca.gov

Crown Service Laptop

Part Number - 340099

The Crown Service Laptop is designed to provide software updates from a protected platform. By disabling internet access, the truck software is more secure and shielded from potential viruses.



Includes the following software packages: Multi Series Download Tool, Set Password Utility, SP3400 Tool, RR5000/RR5200 Tool, Wave Updater, V-Force Charger Interface (V-HFM, V-HFE), Module Utility.

Kit includes: Laptop and Laptop Sleeve
**Not compatible with V-HFM[®], C-5, or software that requires an internet connection.*

Charger Cable 10'

Part Number - 127490

For use on Wave.



Static Field Service Kit

Part Number - 101491

Used to prevent damage to static sensitive components while handling or working with them. Includes: work mat, 15 foot ground cord, adjustable wrist strap, coiled ground cord and manufacturer's instructions.

Accessory Items: Coiled Cord Wrist Strap (P.N. 121425)



PC Download Cable

Part Number - 126456

Serial cable for software download on RR 5000 Series trucks & SP 3400. See kit instructions PF16547.



Commutator Dressing Stones

Part Number - 114888 - 8"x¼"x⁵/₁₆" Grade Finish (F)

Part Number - 301583 - 6"x³/₈"x⁵/₈" Grade Finish (F)

Removes film and dirt buildup on motor commutator. Used on motors with limited room in endhead at commutator. 6 pieces in box.



USB Cables

Part Number - 300118 (6' cable)

USB A to MINI-B 2.0 cable used to program V-HFM Series High Frequency Chargers.



Part Number - 300118-001 (6' cable)

USB A to Micro-B 2.0 cable used to program V-HFM[®] Series High Frequency Chargers.

Commutator Brush Stone Set

Part Number - 101582

For dressing commutators. Used on all Crown brush style motors, lift, steer and accessory. Includes: holder with 2 stones.

Individual Items: Holder (P.N. 101580), Green Finish Stones/Qty. 6

(P.N. 101581 - 1"x³/₄"x⁵/₁₆"

Yellow Medium Stones/Qty. 6

(P.N. 301581 - 1"x³/₄"x⁵/₁₆"



Isolator Connector

Part Number - 062785-001

Used on RR 5000 Series when downloading software.



Trimpot Adjustable Tool

Part Number - 107369

Use to adjust trimpots. (variable resistors) Use on traction and pump controls with trimpot tune-up adjustments.



USB to Serial RS232 Adapter Cable

Part Number - 320058

Used for software downloading on RR5000-RR5200 and SP3400 Traction Modules.



Lighted Adapter Single Outlet

Part Number - 340101

Light inside shows power is on. Plug into any 3-conductor outlet or extension cord.



Software Download Kit

Part Number - 062915-00S

Used with six pin can interface connections to download software to truck. See kit instructions PF16877.

Used on PE 4500, PR 4500, SC 4500, SC 5200, SC 5300, RC 5500, TSP 6000, FC 4500 and SP 3500.



AMP



AMP Crimper

Part Number	Used on Connector Series	Used on Crown Contacts
062726-001	Mate-N-Lock	062036-XXX
062726-002	Mini Mate-N-Lock	062536-XXX
062726-003	Amplimite (dsub)	062526-XXX
062726-004	Multilock 040	062663-XXX
062726-005	Multilock 070	062663-001
062726-006	Ampseal	062721-001



Extraction Tool

Part Number	Used on Crown Contacts
146583-001	062882-001
146583-002	062882-002

Removal of contacts. Amp and Tyco style.



Crimping Tool

Part Number - 090118
 For stripping insulation and crimping new terminals on light gauge electrical wire for insertion into Mate-N-Lock connectors (Amp style). Works on 062037 connectors and 062036 contacts. See TSB 173. One piece tool.



Crimping Tool

Part Number	Used on Crown Contacts
110965	062090-XXX

Serial link cable terminal crimping also used on TS, TSP trucks for the terminals in the screw on connectors on the electronics boxes. Instructions not available (Amp style).



Extraction Tool

Part Number - 090117
 Removal of the Mate-N-Lock pin and socket contacts from various Amp connector blocks. See TSB 173 and TSB 175. Includes one piece tool with manufacturer's instructions.



Extraction Tool

Part Number - 100380
 For removal of the Mate-N-Lock pin and socket contacts from various Amp connector blocks. One piece, spring loaded tool with manufacturer's instructions.



Extraction Tool

Part Number - 100381
 For removal of Amp leaf contacts from sensor amplifier P.C. board receptacle. For trucks with wire guidance systems. Contact removal on receptacles. One piece, spring loaded tool with manufacturer's instructions.

AMP



Extraction/Insertion Tool

Part Number	Used on Crown Contacts
100521	062090-XXX

For extracting and inserting Amp male and female contacts on screw on connectors. Used in the electronics boxes on the 40TS/30TSP trucks. Two piece mated plastic tool (blue end - insertion, white end - extraction).



Extraction Tool

Part Number - 093493
 Removal of lead assemblies from printed circuit board connector receptacles. Used on RR, RS, RD and TS trucks, RR, RS and RD circuit selector box, lamp and P.C. Board (Amp style). Used on contacts 062036-XXX. See TSB 175.



Extraction Tool

Part Number - 126884
 For extracting and inserting Amp male and female contacts on screw in connectors.



Insertion Tool

Part Number - 126885
 25 Replacement tips for extraction tool (P.N. 126884).



Extraction Tool

Part Number - 100522
 Removal of contacts from connectors on traction SCR control, EV100 controls (Amp style).



Extraction Tool

Part Number - 118993
 For removing sockets from connector. Used with 062536 terminals. Amp style, miniature rectangular Mate-N-Lock connectors.



Insertion Tool

Part Number - 100382
 For insertion of unstripped electrical leads into MTA 100 connectors to form a reliable connection. One piece tool.



Insertion Tool

Part Number - 100524
 For insertion of unstripped electrical leads into MTA 156 connectors to form a reliable connection. Used on TS/TSP. One piece tool.

Electrical Tools

Anderson Power Products



Auxiliary Contact Crimp Tool Multi-Die Kit

Part Number - 340084-001

Crimps #6-20AWG SB, SBS, SBE, SBO, Powerpole, Saf-D-Grid, and SPEC Pak Connectors. Includes 3 dies and plastic case.

Cannon



Extraction Tool

Part Number - 100379

For removal of pins from the sensor assembly connector. Used on trucks with Portec wire guidance (Cannon style).



Crimping Tool

Part Number Used on Crown Contacts

118504 | 062589, 062588

Crimp terminals 062589 and 062590, Cannon style.



Extraction Tool

Part Number Used on Crown Contacts

118505 | 062589, 062588

For removing pins on P.N. 062587 and P.N. 062588. Cannon style connectors.

Deutsch



Extraction Tool

Part Number Used on Crown Contacts

062706 | 062704-XXX, 062797-XXX

Used to remove Deutsch pin and socket contacts from DT and DTM connectors.



Crimping Tool

Part Number Used on Crown Contacts

062737-002 | 062704-XXX, 062797-XXX

For stripping insulation and crimping new terminals on light gauge electrical wire for insertion into Deutsch DT and DTM connectors.

Molex



Extraction Tool

Part Number Used on Crown Contacts

117615 | 116858, 129761-XXX, 803450-XXX

For removing pins from mini fit connectors. Used on GPW with Curtis 1207 transistor controller and WP 2000 wiring harness handle.



Crimping Tool

Part Number Used on Crown Contacts

117636 | 116858, 129761-XXX, 803450-XXX

For crimping mini fit terminals to wires. Used on GPW with Curtis 1207 transistor controller. Manufacturer's instructions included.

Molex (continued)

Image Not Available

Crimping Tool

Part Number Used on Crown Contacts

360040-001 | 062899-XXX

For crimping terminals to wires. Used on C5 engine harness terminals.



Extraction Tool

Part Number Used on Crown Contacts

360040-002 | 062899-XXX

For removing pins from connectors. Used on C5 engine harness connectors.

Packard



Crimping Tool

Part Number Used on Crown Contacts

320051 | 062729-XXX

For crimping Packard pin and sleeve terminals. Crimps terminals and seals in a single cycle.



Extraction Tool

Part Number Used on Crown Contacts

320053 | 062729-XXX

For removing pins from Packard connectors.



Crimping Tool

Part Number Used on Crown Contacts

320052 | 062896-XXX

For crimping Packard Metri-pack 150 & 280 sealed 20-14 gauge terminals. Core & insulation wings are crimped in a separate motion.



Extraction Tool

Part Number Used on Crown Contacts

320054 | 062896-XXX

For removing terminals in Packard Metri-pack 150 & 280 connectors.



SB Extraction Tool

Part Number Amps

340089-001 | 175

340089-002 | 350

Weidmuller



Crimping Tool

Part Number Used on Crown Contacts

803452-003 | 803452-005, 803452-006, 803452-008

For stripping insulation and crimping Weidmuller terminals.

⚠ WARNING: Cancer and reproductive harm - www.P65Warnings.ca.gov

Wheel Chocks



Wheel Chock - Small
Part Number - 340094-001
3" x 2.5" x 3"



Wheel Chock
Part Number - 340094-004
3" x 4.9" x 2.6"

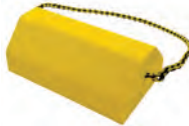

Blocking Outrigger - Large
Part Number - 340094-002
5.8" x 3.6" x 9.5"



Wheel Chock
Part Number - 340094-003
5" x 4" x 8"



Double Wheel Chock
Part Number - 340094-006
9.5" x 5.9" x 3.6"

Cribbing Material



Block
Part Number - 061141
3.5" x 2.5" x 6"



Block Composite
Part Number - 061142-001
RD. 3.5" x 2.5" x 9"
Part Number - 061142-002
RR. 3.5" x 2.5" x 13"



Block Pyramid Surfaced
Part Number - 061144
6" x 7" x 10"



Block Composite
Part Number - 061143-001
Short. 4" x 4" x 22"
Part Number - 061143-002
Long. 4" x 4" x 48"

Mast Blocking Kits

Blocks are rated with a working load limit. Resistant to mold, mildew and insects. Splinter resistant. Does not absorb most chemicals. Easily washable. Does not rot like traditional wood. Always refer to the Control of Hazardous Energy section in the Crown service manual for instructions on blocking the mast and fork carriage.

Part Number	Description	WLL (lbs)	Kit Qty
340094-008	RM Blocking Kit		
	Block with cut out 1.5 x 4.75 x 44.5	7,800	2
	Block 1.5 x 4.75 x 20.5	17,100	2
	Block 1.5 x 4.75 x 11	13,500	1
	Block 3 x 3 x 30	17,100	1

Part Number	Description	WLL (lbs)	Kit Qty
340094-009	TSP Blocking Kit		
	Block with cut out 3 x 3.75 x 48	15,600	2
	Block 3 x 3.75 x 14	21,300	2



Additional Recommended Item:
F-Clamp Bahco 16" (P.N. 320076)



C-5 Brake Tools



SAHR Cap Tool

Part Number - 360057

Used for C-5 power brake equipped lift trucks to remove and install brake SAHR cap.

C-5 Engine Tools



Compression Gauge and Hose Assembly

Part Number - 145739

High Quality Snap on Engine Compression Gauge for measuring cylinder compression on internal combustion engines.

Accessory Items: Compression Test Assembly (P.N. 145006)

Adapter to be used with the 145739 Engine Compression Gauge. This is required for measuring cylinder compression on C-5, RST-50 and RP-50 internal combustion forklifts.

Replacement part: Schrader valve/check valve - P.N. 145740



4024 Electronic Data Link Kit

Part Number - 164229

Used for downloading RST-50 & C-5 software into truck.



Wrench Fan Bearing Bushing

Part Number - 360054

Used to tighten or loosen engine fan on RST-50 & C-5 models without ODC.



Hydraulic Lifter Bleed Down Tool

Part Number - 141920

Used to disperse oil from the lifters on C-5 when replacing the cylinder head.

A 144998 flywheel timing lock pin is also recommended.



KIRA Diagnostic Tool

Part Number - 323098

Basic configuration. Used for C-5 Diesel trucks with Kohler engine. Contact Crown Technical Support for activation. Requires a 3 year subscription fee (first 3 years included with purchase of tool).

Cable from VCI diagnostic connector to DEUTSCH (P.N. 323099).

⚠ **WARNING:** Cancer and reproductive harm - www.P65Warnings.ca.gov

C-5 Transaxle Tools



Transaxle Socket Tool

Part Number - 360055

C-5 transaxle dual purpose socket for C-5 transaxle rebuild. Also, works with Pinion Shaft Socket 360060 to loosen and tighten pinion shaft nut. Long socket extension used with a press to compress clutch shaft friction plate spring for friction plate removal.

C-5 Transaxle Tools



Pinion Shaft Nut Socket

Part Number - 360060

Used with transaxle socket tool 360055 as a drive/extension to loosen and tighten pinion shaft nut.



Trans Puller Set With Bag

Part Number - 360056

Used for C-5 & RST transaxle rebuilds to remove internal bearings.



Spanner Wrench

Part Number - 360046

Used to assemble and tighten C-5 differential carrier bearing adjuster ring nut.



Axle Bearing Tool

Part Number - 145012

Used to assist in removing drive axle hubs. Fits into end of of axle on RST-50 and C-5 models to give puller tool a platform to press against.



Bushing Installation Tool

Part Number - 144931

Used to install drive axle bushings (145321) on RST-50 and C-5 models.



Axle Hub Alignment Tool

Part Number - 143129

Used to install drive axle hub on RST-50 and C-5 models. Helps align hub and protects hub seal when installing drive hubs. Use with 143130 axle hub alignment tool.



Axle Hub Bearing Driver Tool

Part Number - 143130

Used to install drive axle hub on RST-50 and C-5 models. Use with 143129 axle hub alignment tool.



Hub Seal Installation Tool

Part Number - 065208

Used to install drive hub inner seals on RST-50 and C-5 models. Helps to position seal at the correct depth and prevents seal damage.

⚠ **WARNING:** Cancer and reproductive harm - www.P65Warnings.ca.gov



Transmission Pressure Test Kit

Part Number - 360042

Used for checking C-5/RST transmission pressures during troubleshooting.



Pinion Shaft Socket

Part Number - 360047

Used to set pinion shaft bearing per load on C-5 transaxle.

IC Lift Truck Tools

C-D Tools



Diesel Diagnostic Tool

Part Number - 860104-01045

This Diagnostic tool consists of several functions to verify engine condition, fault code detecting and resolving, test, ECU reprogramming. You can also find present or historic codes with troubleshooting guide for resolving these. Enables to check or logging sensors and service data values.

Accessories: CD-9 Diagnostic Cable (PN 310207-11177)



310207-11177



Diesel Refractometer Kit

Part Number - 390224

In order to properly verify and check Diesel Exhaust Fluid (DEF) a special tester (Refractometer) is required. The refractometer is used to measure the quality or specific gravity (31.8% - 33.2%) of the DEF.

C-G Tools



PSI Diagnostic Tool

Part Number - 101529-00207

For both Crown C-G and Hamech units. Using the E-Controls GCP Diagnostic Scan Tool (DST), the Technician can not only read Trouble Codes, but also view real-time streams of Engine Sensor Data.



PSI Diagnostic Plug

Part Number - 33001197

For both Crown C-G and Hamech units. Allows you to retrieve Trouble Codes without using the GCP Diagnostic Scan Tool.



PSI Adapter Cable

Part Number - 430201-02466

Engine diagnostic connector for the CGC 35-55-9 Cushion, CG NXP, and CG 35-50-7 Pneumatic. Used with the 101529-00207 PSI Diagnostic Tool.

Miscellaneous

Continued ▶



Grease Gun, Lever Handle 10,000 PSI

Part Number - 323000

Rugged pump with cast iron head for strength and durability. Heavy-duty plated steel lever handle. "Flip-Over" follower allows for a superior seal. For use with 16 ounce bulk or 14.5 ounce cartridge.

Accessories:

18" Whip Hose Extension - P.N. 323000-100

Hydraulic Coupler - P.N. 323000-101

Note: Both parts can be added to 323000 to make a flex hose.

323000-100

323000-101



3M™ Roloc™ Disc Pads



323022



323023

3M™ Roloc™ Disc Pads optimize the performance of Roloc™ discs and bristle discs by providing the right backup system and a secure attachment for grinding applications. Saves time by eliminating the need to align edges of the disc with the disc pad—the screw aligns the disc, making disc changes quick and easy.

- Disc pad provides secure attachment for any 3M™ Roloc™ disc or bristle product.
- Versatile system works with drills, disc sanders, right angle grinders, and rotary sanders.

Part No.	Description	DxH	Grit	Type
323022	Disc Pad - 2"	2" x 1/4-20 INT	Med	TR (Plastic Button)
323023	Disc Pad - 3"	3" x 1/4-20 INT	Med	TR (Plastic Button)



Grease Gun, Lever Handle 10,000 PSI

Part Number - 323000-001

Flex hose nozzle extension. Rugged pump with cast iron head for strength and durability. Heavy duty plated steel lever handle. Barrel with flip follower allows for a superior seal. For use with 16 ounce bulk or 14.5 ounce cartridge.



Grease Gun, Pistol Grip Handle 3,500 PSI

Part Number - 323001

Flex-hose nozzle extension. Includes die-cast aluminum pump head, hose and follower.



Adhesive Eraser

Part Number	Description
380030-191	3M™ Adhesive Eraser Wheel

Easy to use tool for removing adhesives and films from painted surfaces. Will not scratch or damage acrylic enamel or urethane paint. For use with electric drill. Eraser wheel dimensions: 4" x 3/8". Attachment: 3/8".

3M™ Scotch-Brite Surface Conditioning Discs, Roloc™



323002



323004



323005



323003

Part No.	Diam.	Color	Grit	Sales Unit
323002	2"	Brown	Coarse	25/box
323003	2"	Maroon	Medium	25/box
323004	3"	Brown	Coarse	25/box
323005	3"	Maroon	Medium	25/box

For cleaning and finishing on all metals for removal of light rust, oxides and coatings. Great for decorative finishes, cleaning applications and deburring. Aluminum Oxide grit.

Miscellaneous

3M™ Corps Roloc™ Sanding Discs



323006



323007

Part No.	Diam.	Color	Grit	Sales Unit
323006	2"	Brown	50	50/box
323007	3"	Green	36	25/box

Generally used to remove paint, rust and welds in metal grinding applications. Aluminum Oxide grit.

3M™ Corps Roloc™ Sanding Discs



Part No.	Diam.	Color	Grit	Sales Unit
323008	2"	Brown	60	50/box

Tough abrasive disc for a fast cutting, long lasting abrasive. Provides superior performance in high pressure applications. Excellent flexibility with a durable backing allows the disc to be used in hard to reach areas. Max RPM 25,000.

Cut-Off Wheel



Part No.	Diam.	Hole Size	Grit	Sales Unit
BD3038	4-1/2"	7/8"	60	1 each

4.5" x 0.045" Aluminum Oxide cut-off wheel. Medium grade, reinforced, Maximum RPM 13,300. Best suited for general purpose deburring and blending.

CGW Camel Grinding Wheel



Part No.	Diam.	Hole Size	Grit	Sales Unit
323021	6"	7/8"	60	25/box

6" x 0.045". More durable than Aluminum Oxide, Zirconia-Alumina is best for medium to heavy material removal. The material grains constantly fracture to produce new sharp edges. Commonly used on carbon steels, aerospace alloys, nickel alloys and cast iron.

⚠ **WARNING:** Cancer - www.P65Warnings.ca.gov

Rubber Tires For your Mixed Fleet

- Ranging from Press on Rubber, Solid Resilient, and Industrial Pneumatic Tires
- Tires can come in Marking or Non-Marking
- Tread designs, smooth for dry surfaces and traction when extra grip is required.

See the Wheels and Tires Section for more information



V-Force Barbed Valve Watering System

Make Battery Watering Easy



- Fill battery cells in less time
- Extend battery life
- Tubing resists kinks or crushing
- Compatible with other barbed valve designs
- System is virtually maintenance free

See Section 8
For the Battery and Charger Accessories

Section 10

Hydraulic Components

Contents

Thermoplastic Hose Couplings	10.02
Thermoplastic Hose	10.04
Rubber Hose Couplings	10.05
Rubber Hose	10.08

Note: See Section 9, Tools, for a list of hydraulic tools, including power crimps, dies, pushers, hose cutters, and swager tools.

Note: 1910.178(q)(5) (1998) of the Occupational Safety and Health Act (OSHA) requires that "All parts of any such industrial truck requiring replacement shall be replaced only by parts equivalent as to safety with those used in the original design."

The installation onto a lift truck of non-certified electronic components may invalidate a truck's UL EE or LPS listing and could pose a safety risk. Customers with UL-listed lift trucks are solely responsible for ensuring compliance with UL for field modifications. The selection of non-OEM parts is made solely by the customer with the awareness that OEM parts are available. Crown Equipment Corporation is unaware of what testing and/or certification, if any, the non-OEM parts have undergone and disclaims all warranties and representations regarding any non-OEM part.



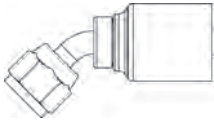

45° Bent Tube Female Swivel, JIC 37°

Hose I.D.	Thread	Drop Length (in)	Vendor Number	Part Number	Fitting Hose Depth (in)
3/16	7/16 - 20	0.33	4TA4FJA3	064682-001	1.03
1/4	7/16 - 20	0.33	4TA4FJA4	064682-002	0.85
5/16	9/16 - 18	0.39	4T6FJA5	064682-003	1.18
3/8	9/16 - 18	0.39	4TA6FJA6	064682-004	1.31
3/8	3/4 - 16	0.55	4TA8FJA6	064682-005	2.65
1/2	3/4 - 16	0.55	4TA8FJA8	064682-006	1.86
1/2	7/8 - 14	0.61	4TA10FJA8	064682-007	1.66

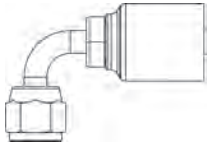

90° Bent Tube Female Swivel, JIC 37°

Hose I.D.	Thread	Drop Length (in)	Vendor Number	Part Number	Fitting Hose Depth (in)
3/16	7/16 - 20	0.68	4TA4FJB3	064683-001	1.03
1/4	7/16 - 20	0.68	4TA4FJB4	064683-002	0.92
1/4	7/16 - 20	0.78	4TA4FJB40.22	064683-003	0.92
1/4	7/16 - 20	1.8	4TA4FJC4	064683-004	0.92
1/4	1/2 - 20	0.77	4TA5FJB4	064683-005	1.00
1/4	9/16 - 18	0.85	4TA6FJB4	064683-006	1.08
5/16	9/16 - 18	0.85	4T6FJB5	064683-007	1.09
5/16	9/16 - 18	2.18	4TA6FJC5	064683-008	1.04
3/8	9/16 - 18	0.85	4TA6FJB6	064683-009	1.22
3/8	9/16 - 18	2.18	4TA6FJC6	064683-010	1.23
3/8	3/4 - 16	1.09	4TA8FJB6	064683-011	1.42
3/8	3/4 - 16	2.43	4TA8FJC6	064683-012	1.54
1/2	3/4 - 16	1.09	4TA8FJB8	064683-013	1.42
1/2	3/4 - 16	2.43	4TA8FJC8	064683-014	1.54
1/2	7/8 - 14	1.21	4TA10FJB8	064683-015	1.61
1/2	7/8 - 14	2.57	4TA10FJC8	064683-016	1.61

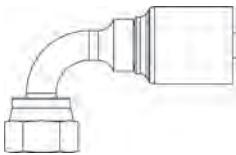

90° Elbow Female Swivel, O-Ring Face Seal

Hose I.D.	Thread	Drop Length (in)	Vendor Number	Part Number	Fitting Hose Depth (in)
1/4	9/16 - 18	0.82	4TA4FRB4	064687-001	1.17
1/4	11/16 - 16	0.9	4TA6FRB4	064687-002	1.30
5/16	11/16 - 16	0.9	4T6FRB5	064687-003	1.31
5/16	11/16 - 16	2.13	4TA6FRC5	064687-004	1.35
3/8	11/16 - 16	0.9	4TA6FRB6	064687-005	1.34
3/8	11/16 - 16	2.13	4TA6FRC6	064687-006	1.34
1/2	13/16 - 16	1.15	4TA8FRB8	064687-007	1.67

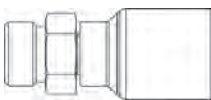

Male O-Ring Face Seal

Hose I.D.	Thread	Drop Length (in)	Vendor Number	Part Number	Fitting Hose Depth (in)
1/4	9/16 - 18	N/A	4TA4MR4	064688-001	0.86
3/8	11/16 - 16	N/A	4TA6MR6	064688-002	1.16
3/8	13/16 - 16	N/A	4TA8MR6	064688-003	0.95
1/2	13/16 - 16	N/A	4TA8MR8	064688-004	1.34



Male O-Ring Straight Thread

Hose I.D.	Thread	Drop Length (in)	Vendor Number	Part Number	Fitting Hose Depth (in)
3/16	7/16 - 20	N/A	4TA4MB3	064689-001	0.72
1/4	7/16 - 20	N/A	4TA4MB4	064689-002	0.92
1/4	1/2 - 20	N/A	4TA5MB4	064689-003	0.92
1/4	9/16 - 18	N/A	4TA6MB4	064689-004	0.85
5/16	9/16 - 18	N/A	4TA6MB5	064689-005	0.87
3/8	9/16 - 18	N/A	4TA6MB6	064689-006	1.00
3/8	3/4 - 16	N/A	4TA8MB6	064689-007	0.98

*Note: See Section 9, Tools, for pusher and die Crown part numbers.

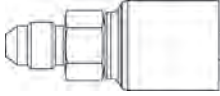

JIC 37° Male Rigid

Hose I.D.	Thread	Drop Length (in)	Vendor Number	Part Number	Fitting Hose Depth (in)
3/16	7/16 - 20	N/A	4TA4MJ3	064684-001	0.91
1/4	7/16 - 20	N/A	4TA4MJ4	064684-002	1.07
1/4	1/2 - 20	N/A	4TA5MJ4	064684-003	0.92
1/4	9/16 - 18	N/A	4TA6MJ4	064684-004	0.93
5/16	1/2 - 20	N/A	4TA5MJ5	064684-005	1.12
5/16	9/16 - 18	N/A	4TA6MJ5	064684-006	0.94
3/8	9/16 - 18	N/A	4TA6MJ6	064684-007	1.22
3/8	3/4 - 16	N/A	4TA8MJ6	064684-008	1.11
1/2	3/4 - 16	N/A	4TA8MJ8	064684-009	1.40
1/2	7/8 - 14	N/A	4TA10MJ8	064684-010	1.26

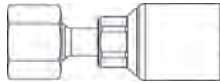

Straight with Female Swivel O-Ring Face Seal

Hose I.D.	Thread	Drop Length (in)	Vendor Number	Part Number	Fitting Hose Depth (in)
1/4	9/16 - 18	N/A	4TA4FR4	064685-001	1.03
1/4	11/16 - 16	N/A	4TA6FR4	064685-002	1.12
5/16	11/16 - 16	N/A	4T6FR5	064685-003	1.13
3/8	11/16 - 16	N/A	4TA6FR6	064685-004	1.24
3/8	13/16 - 16	N/A	4TA8FR6	064685-005	1.32
1/2	13/16 - 16	N/A	4TA8FR8	064685-006	1.50
1/2	1 - 14	N/A	4TA10FR8	064685-007	1.47
5/8	1 - 14	N/A	4TA10FR10	064685-008	1.61

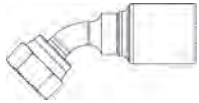

Female Swivel O-Ring Face Seal 45° Bend

Hose I.D.	Thread	Drop Length (in)	Vendor Number	Part Number	Fitting Hose Depth (in)
1/4	9/16 - 18	0.41	4TA4FRA4	064686-001	1.20
3/8	11/16 - 16	0.43	4TA6FRA6	064686-002	1.43

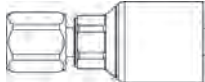

JIC 37° Female Swivel

Hose I.D.	Thread	Drop Length (in)	Vendor Number	Part Number	Fitting Hose Depth (in)
3/16	3/8 - 24	N/A	4TA3FJ3	064681-001	1.00
3/16	7/16 - 20	N/A	4TA4FJ3	064681-002	1.00
3/16	1/2 - 20	N/A	4TA5FJ3	064681-003	1.05
1/4	7/16 - 20	N/A	4TA4FJ4	064681-004	1.08
1/4	1/2 - 20	N/A	4TA5FJ4	064681-005	1.14
1/4	9/16 - 18	N/A	4TA6FJ4	064681-006	1.11
5/16	1/2 - 20	N/A	4TA5FJ5	064681-007	1.14
5/16	9/16 - 18	N/A	4TA6FJ5	064681-008	1.12
3/8	7/16 - 20	N/A	4TA4FJ6	064681-009	1.19
3/8	1/2 - 20	N/A	4TA5FJ6	064681-010	1.24
3/8	9/16 - 18	N/A	4TA6FJ6	064681-011	1.27
3/8	3/4 - 16	N/A	4TA8FJ6	064681-012	1.34
1/2	3/4 - 16	N/A	4TA8FJ8	064681-013	1.44
1/2	7/8 - 14	N/A	4TA10FJ8	064681-014	1.54
1/2	1 1/16 - 12	N/A	4TA12FJ8	064681-015	1.59
5/8	7/8 - 14	N/A	4TA10FJ10	064681-016	1.61
5/8	1 1/16 - 12	N/A	4TA12FJ10	064681-017	1.57

Thermoplastic Hose Couplings

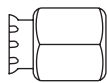

Cap

Part Number	Thread	Depth
064128-001	3/4-16	0.75
064128-002	9/16-18	0.62
064128-003	7/16-20	0.59
064128-004	1 1/16-12	1.02
064128-005	7/8-14	0.97

⚠️ **WARNING:** Cancer and reproductive harm - www.P65Warnings.ca.gov

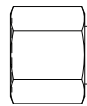

Cap O-Ring Face Seal

Part Number	Thread	Depth
064311S004	9/16-18	0.58
064311S006	11/16-16	0.67
064311S008	13/16-16	0.83
064311S010	1-14	0.93
064311S012	1 3/16-12	1.02

⚠️ **WARNING:** Cancer and reproductive harm - www.P65Warnings.ca.gov

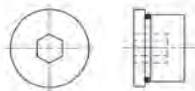

Plug with O-Ring

Part Number	Thread	Depth	Tube Size	
			SAE	OD
064091-001	3/4 - 16	0.438	8	0.50
064091-002	9/16 - 18	0.391	6	0.38
064091-004	5/16 - 24	0.297	2	0.12
064091-005	1-1/16 - 12	0.594	12	0.75
064091-006	7/16- 20	0.360	4	0.25
064091-007	7/8 - 14	0.500	10	0.62
064091-008	1-5/16 - 12	0.594	16	1.00
064091-009*	1-1/16 - 12	0.594	12	0.75
064091-010	3/8 - 24	0.297	3	0.19
064091-011*	1-7/8 - 12	0.594	24	1.50

⚠️ **WARNING:** Cancer and reproductive harm - www.P65Warnings.ca.gov

* O-Ring not included.

Note: See Section 9, Tools, for pusher and die Crown part numbers.

Thermoplastic Hose

Synflex - Fiber Braided Thermoplastic Hose SAE 100R18

I.D.	Vendor Number	Maximum Working Pressure	250 ft roll
1/4	3TR18CT-04	3050	064680-040
5/16	3TR18CT-05	3050	064680-050
3/8	3TR18CT-06	3050	064680-060
1/2	3TR18CT-08	3050	064680-080
5/8	3TR18CT-10	3050	064680-100

Note: 3TR18CT replaces 3160, 3360 and 30CT sizes 1/4" to 5/8".

Synflex - Fiber Braided Thermoplastic Hose SAE 100R7

I.D.	Vendor Number	Maximum Working Pressure	250 ft roll
3/16	3TR7-03	3000	064691-030

Thermoplastic Hose Cross Reference

Part Number (250 ft Roll)	Synflex	*Former Synflex	Dayco Parker	Aeroquip	Eastman
064691-030	3TR7-03	3160-03	55LT-3	FC372-03	NA
064680-040	3TR18CT-04	3160-04	55LT-4	FC372-04	C204
064680-050	3TR18CT-05	3160-05	55LT-5	FC372-05	C205
064680-060	3TR18CT-06	3160-06	55LT-6	FC372-06	C206
064691-030	3TR7-03	3160-03	540N-3	NA	NA
064680-040	3TR18CT-04	3160-04	540N-4	NA	NA
064680-050	3TR18CT-05	3160-05	540N-5	NA	NA
064680-060	3TR18CT-06	3160-06	540N-6	NA	NA
064691-030	3TR7-03	3160-03	550H-3	NA	NA
064680-040	3TR18CT-04	3160-04	550H-4	NA	NA
064680-050	3TR18CT-05	3160-05	550H-5	NA	NA
064680-060	3TR18CT-06	3160-06	550H-6	NA	NA
064680-100	3TR18CT-10	3360-10	53LT-10	NA	NA
320046	NA	3R80-06	520N-6	NA	NA
064680-060	3TR18CT-06	30CT-06	55LT-06	30CT-06	NA
064680-100	3TR18CT-10	30CT-10	55LT-10	30CT-10	NA
064680-080	3TR18CT-08	30CT-08	55LT-08	30CT-08	NA
064680-100	3TR18CT-10	3360-10	53DM-10	NA	NA

Note: Although all Synflex hoses meet or exceed the pressure ratings of the competitors equivalent hose, not all are made from the same materials or construction nor were designed for the exact same applications.

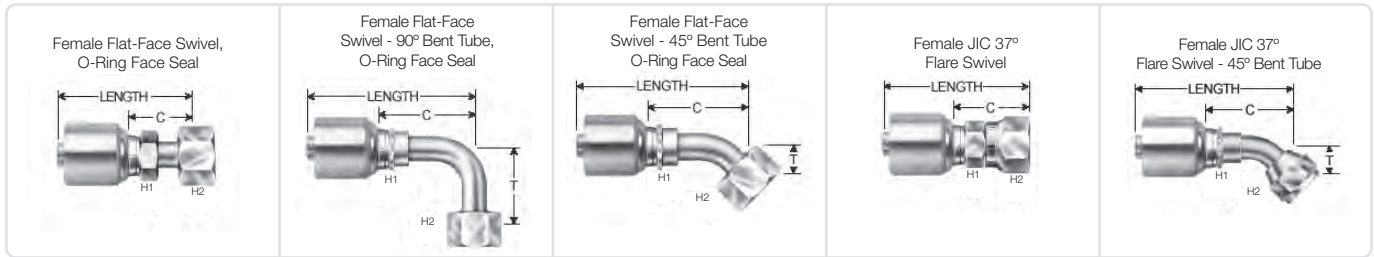

Hose I.D. mm (in.)	Vendor Number	Part Number	Thread Size	H1 (in)	H2 (in)	"T" Drop mm (in)	Length mm (in)	"C" Cut-Off mm (in)
Female Flat-Face Swivel, O-Ring Face Seal								
6.4 (1/4)	4G-4FFORX	320042-001	9/16-18	9/16	11/16	NA	54.5 (2.15)	28.5 (1.12)
6.4 (1/4)	4G-6FFORX	320042-002	11/16-16	5/8	13/16	NA	57 (2.24)	31 (1.22)
9.5 (3/8)	6G-4FFORX	320042-085	9/16-18	21/32	11/16	NA	57 (2.24)	29.1 (1.15)
9.5 (3/8)	6G-6FFORX	320042-003	11/16-16	5/8	13/16	NA	59 (2.32)	31 (1.22)
9.5 (3/8)	6G-8FFORX	320037	13/16-16	3/4	15/16	NA	64 (2.52)	36.1 (1.42)
12.7 (1/2)	8G-8FFORX	320042-004	13/16-16	13/16	15/16	NA	73.5 (2.89)	36 (1.42)
12.7 (1/2)	8G-10FFORX	320042-051	1-14	15/16	1-1/8	NA	81.0 (3.19)	43.5 (1.71)
12.7 (1/2)	8G-12FFORX	320042-087	1 3/16-12	15/16	1-3/8	NA	84.3 (3.32)	46.8 (1.84)
15.8 (5/8)	10G-10FFORX	320042-005	1-14	1	1-1/8	NA	81.5 (3.21)	44.0 (1.73)
19.0 (3/4)	12G-12FFORX	320042-088	1 3/16-12	1 1/16	1-3/8	NA	96.0 (3.78)	45.0 (1.77)
Female Flat-Face Swivel 90° Bent Tube, O-Ring Face Seal								
6.4 (1/4)	4G-4FFORX90S	320042-013	9/16-18	1/2	11/16	20.8 (0.82)	60.4 (2.38)	34.4 (1.35)
6.4 (1/4)	4G-4FFORX90M	320042-014	9/16-18	1/2	11/16	32.0 (1.26)	55.2 (2.17)	29.2 (1.15)
6.4 (1/4)	4G-4FFORX90L	320042-015	9/16-18	1/2	11/16	45.7 (1.80)	55.2 (2.17)	29.2 (1.15)
9.5 (3/8)	6G-6FFORX90S	320042-016	11/16-16	5/8	13/16	22.9 (0.90)	64.7 (2.55)	36.7 (1.44)
9.5 (3/8)	6G-6FFORX90M	320042-077	11/16-16	5/8	13/16	38.4 (1.51)	64.7 (2.55)	36.8 (1.45)
9.5 (3/8)	6G-6FFORX90L	320042-048	11/16-16	5/8	13/16	54.1 (2.13)	62.9 (2.48)	35.0 (1.38)
9.5 (3/8)	6G-8FFORX90S	320042-017	13/16-16	5/8	15/16	29.2 (1.15)	73.0 (2.87)	45.0 (1.77)
12.7 (1/2)	8G-8FFORX90S	320042-018	13/16-16	13/16	15/16	29.2 (1.15)	83.9 (3.30)	46.5 (1.83)
12.7 (1/2)	8G-8FFORX90M	320042-047	13/16-16	13/16	15/16	41.2 (1.62)	83.9 (3.30)	46.5 (1.83)
12.7 (1/2)	8G-8FFORX90L	320042-046	13/16-16	13/16	15/16	63.8 (2.51)	83.9 (3.30)	46.5 (1.83)
12.7 (1/2)	8G-8FFORX90-083	320042-052	13/16-16	13/16	15/16	83.0 (3.26)	83.9 (3.30)	46.5 (1.83)
12.7 (1/2)	8G-10FFORX90S	320042-019	1-14	13/16	1-1/8	32.3 (1.27)	84.0 (3.30)	46.5 (1.83)
15.8 (5/8)	10G-10FFORX90S	320042-020	1-14	15/16	1-1/8	32.3 (1.27)	83.4 (3.28)	45.9 (1.81)
15.8 (5/8)	10G-10FFORX90M	320042-075	1-14	15/16	1-1/8	47.0 (1.85)	77.6 (3.06)	40.2 (1.58)
15.8 (5/8)	10G-10FFORX90L	320042-053	1-14	15/16	1-1/8	70.1 (2.76)	77.5 (3.05)	40.0 (1.57)
19.0 (3/4)	12-G12FFORX90M	320042-089	1 3/16-12	11/16	1-5/8	57.9(2.28)	106.8(4.20)	55.8 (2.20)
Female Flat-Face Swivel - 45° Bent Tube, O-Ring Face Seal								
6.4 (1/4)	4G-4FFORX45	320042-008	9/16-18	9/16	11/16	10.4 (0.41)	65 (2.56)	39 (1.54)
6.4 (1/4)	4G-6FFORX45	320042-009	11/16-16	5/8	13/16	10.9 (0.43)	68.5 (2.70)	42.5 (1.67)
9.5 (3/8)	6G-6FFORX45	320042-010	11/16-16	5/8	13/16	10.9 (0.43)	69.8 (2.75)	41.9 (1.65)
9.5 (3/8)	6G-4FFORX45S	320042-083	9/16-18	5/8	11/16	10.0(0.39)	66.1 (2.60)	38.1 (1.50)
12.7 (1/2)	8G-8FFORX45	320042-011	13/16-16	13/16	15/16	15 (0.59)	89 (3.5)	52.5 (2.07)
12.7 (1/2)	8G-10DD0EZ45	320042-084	1-14	13/16	1-1/8	16.5 (0.65)	89.5 (3.52)	52.1 (2.05)
15.8 (5/8)	10G-10FFORX45	320042-012	1-14	1	1-1/8	16.5 (0.65)	89 (3.5)	51.4 (2.02)
Female JIC 37° Flare Swivel English Hex								
6.4 (1/4)	4GE-4FJX	320042-059	7/16 - 20	1/2	9/16	NA	53.4 (2.10)	27.4 (1.08)
6.4 (1/4)	4GE-6FJX	320042-060	9/16 - 18	9/16	3/4	NA	56.3 (2.22)	30.2 (1.19)
9.5 (3/8)	6GE-6FJX	320042-061	9/16-18	5/8	3/4	NA	58.8 (2.31)	30.2 (1.19)
9.5 (3/8)	6GE-8FJX	320042-062	3/4-16	11/16	7/8	NA	63.1 (2.48)	35.1 (1.38)
Female JIC 37° Flare Swivel - 45° Bent Tube								
6.4 (1/4)	4GE-4FJX45	320042-063	7/16 - 20	1/2	9/16	11.9 (.47)	58.0 (2.28)	32.0 (1.26)
6.4 (1/4)	4G-5FJX45S	320042-054	1/2-20	1/2	5/8	14.2 (0.56)	65.0 (2.56)	39.0 (1.54)
9.5 (3/8)	6G-6FJX45	320042-023	9/16-18	5/8	11/16	14.2 (0.56)	73.9 (2.91)	46.0 (1.81)
9.5 (3/8)	6G-8FJX45	320042-050	3/4-16	5/8	7/8	17.5 (0.69)	73.1 (2.88)	45.2 (1.78)
12.7 (1/2)	8G-8FJX45	320042-044	3/4-16	13/16	7/8	17.5 (.69)	84.1 (3.31)	46.6 (1.83)

⚠WARNING: Cancer and reproductive harm - www.P65Warnings.ca.gov

Rubber Hose Couplings

Continued ▶

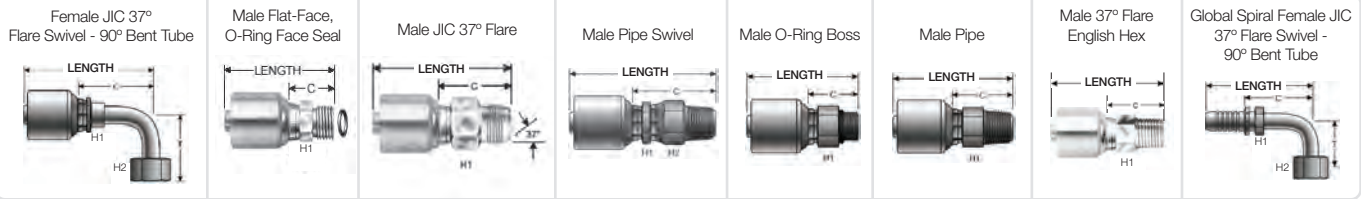

Hose I.D. mm (in.)	Vendor Number	Part Number	Thread Size	H1 (in)	H2 (in)	"T" Drop mm (in)	Length mm (in)	"C" Cut-Off mm (in)
Female JIC 37° Flare Swivel								
6.4 (1/4)	4G-4FJX	320042-021	7/16-20	1/2	9/16	NA	53.4 (2.10)	27.4 (1.08)
6.4 (1/4)	4G-6FJX	320042-037	9/16-18	9/16	3/4	NA	56.3 (2.22)	30.2 (1.19)
9.5 (3/8)	6G-6FJX	320042-022	9/16-18	5/8	3/4	NA	58.8 (2.31)	30.2 (1.19)
9.5 (3/8)	10643-6-6	320073	9/16-18	11/16	11/16	NA	58 (2.29)	32.0 (1.26)
9.5 (3/8)	6G-8FJX	320042-031	3/4-16	11/16	7/8	NA	63.1 (2.48)	35.1 (1.38)
12.7 (1/2)	8G-8FJX	320042-045	3/4-16	13/16	7/8	NA	71.6 (2.82)	34.1 (1.34)
12.7 (1/2)	8G-12FJX	320042-073	1 1/16 - 12	1	1-1/4	NA	80.1 (3.15)	42.6 (1.68)
15.8 (5/8)	10G-8FJX	320042-071	3/4-16	15/16	7/8	NA	73.6 (2.90)	36.1 (1.42)
15.8 (5/8)	10G-10FJX	320042-042	7/8-14	15/16	1-1/16	NA	77.1 (3.04)	39.7 (1.56)
Female JIC 37° Flare Swivel - 90° Bent Tube								
6.4 (1/4)	4G-4JX90M	320042-072	7/16 - 20	1/2	9/16	22.4 (0.88)	52.25 (2.06)	26.2 (1.03)
6.4 (1/4)	4G-5FJX90L	320042-039	1/2 - 20	1/2	5/8	45.7 (1.80)	55.2 (2.17)	29.2 (1.15)
9.5 (3/8)	6G-6FJX90S	320042-024	9/16 - 18	5/8	11/16	21.6 (0.85)	60 (2.36)	31.0 (1.22)
9.5 (3/8)	6GE-6FJX90S	320042-064	9/16 - 18	5/8	11/16	85.0 (21.6)	60.0 (2.36)	31.0 (1.22)
9.5 (3/8)	6G-6FJX90M	320042-025	9/16 - 18	5/8	11/16	28.7 (1.13)	60.0 (2.36)	31.0 (1.22)
9.5 (3/8)	6G-6FJX90L	320042-040	9/16 - 18	5/8	11/16	55.4 (2.18)	66.0 (2.60)	38.1 (1.50)
9.5 (3/8)	6G-8FJX90S	320042-038	3/4 - 16	5/8	15/16	27.7 (1.09)	69.7 (2.74)	41.8 (1.65)
9.5 (3/8)	6GE-8FJX90S	320042-065	3/4 - 16	5/8	7/8	27.7 (1.09)	69.7 (2.74)	41.8 (1.65)
12.7 (1/2)	8G-8FJX90S	320042-074	3/4 - 16	13/16	7/8	29.0 (1.14)	80.3 (3.16)	42.8 (1.69)
12.7 (1/2)	8G-8FJX90M	320042-043	3/4 - 16	13/16	7/8	41.0 (1.38)	74.3 (2.93)	36.8 (1.45)
12.7 (1/2)	8G-8FJX90L	320042-078	3/4 - 16	13/16	7/8	64.0 (2.52)	74.0 (2.91)	36.6 (1.44)
12.7 (1/2)	8G-10FJX90M	320042-049	7/8 - 14	13/16	1	44.5 (1.75)	81.3 (3.20)	43.9 (1.73)
15.8 (5/8)	10G-10FJX90S	320042-041	7/8 - 14	15/16	1	31.2 (1.23)	85.5 (3.37)	48.0 (1.89)
Male Flat-Face, O-Ring Face Seal								
9.5 (3/8)	6G-6MFFOR	320042-006	11/16 - 16	3/4	NA	NA	56.0 (2.20)	28.1 (1.11)
9.5 (3/8)	6G-8MFFOR	320042-007	13/16 - 16	7/8	NA	NA	59.0 (2.32)	31.1 (1.22)
15.8(5/8)	10G-12MFFOR	320042-069	1 3/16 - 12	1-1/4	NA	NA	72.0 (2.83)	34.5 (1.36)
19.0 (3/4)	12G-12MFFOR	320042-090	1 3/16-12	1-1/4	NA	NA	90.0 (3.54)	39.0 (1.54)
Male JIC 37° Flare								
9.5 (3/8)	6G-6MJ	320042-032	9/16-18	5/8	NA	NA	57.5 (2.26)	29.6 (1.17)
9.5 (3/8)	6G-8MJ	320042-033	3/4-16	3/4	NA	NA	61.0 (2.40)	33.1 (1.30)
Male Pipe Swivel								
9.5 (3/8)	6G-4MPX	320042-055	1/4 - 18	5/8	NA	NA	72.8 (2.87)	44.9 (1.77)
9.5 (3/8)	6G-6MPX	320042-056	3/8 - 18	5/8	NA	NA	71.5 (2.81)	43.6 (1.72)
9.5 (3/8)	6G-8MPX	320042-057	1/2 - 14	3/4	NA	NA	77.5 (3.05)	49.5 (1.95)
Male O-Ring Boss								
6.4 (1/4)	4G-4MB	320042-082	7/16 -20	9/16	NA	NA	50.5 (1.99)	24.5 (0.96)
Male Pipe								
6.4 (1/4)	4G-4MP	320042-036	1/4 - 18	9/16	NA	NA	55.0 (2.17)	29.0 (1.14)
9.5 (3/8)	6G-4MP	320042-076	1/4 - 16	5/8	NA	NA	59.0 (2.32)	31.1 (1.22)
Male 37° Flare English Hex								
9.5 (3/8)	6GE-8MJ	320042-058	3/4-16	3/4	NA	NA	61.0 (2.40)	33.1 (1.30)
Global Spiral Female JIC 37° Flare Swivel 90° Bent Tube								
12.7 (1/2)	8GS-8FJX90S	320042-081	3/4 - 16	7/8	7/8	29.0 (1.14)	86.0 (3.39)	48.6 (1.91)
12.7 (1/2)	8GS-8FJX90M	320042-080	3/4 - 16	7/8	7/8	41.0 (1.61)	92.0 (3.62)	54.6 (2.15)

⚠WARNING: Cancer and reproductive harm - www.P65Warnings.ca.gov

Rubber Hose Couplings

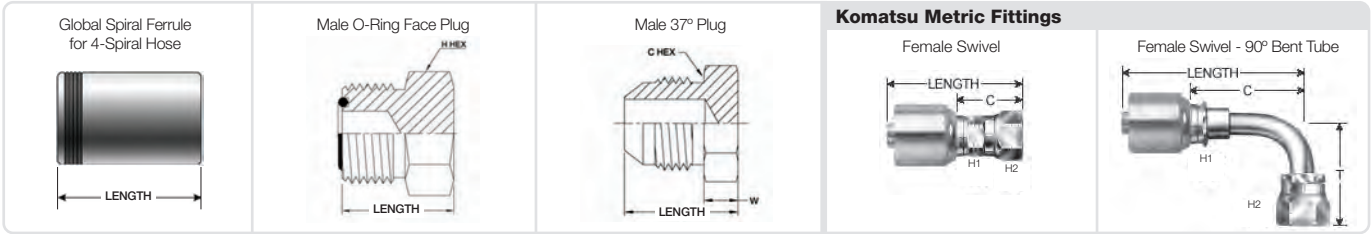

Hose I.D. mm (in.)	Vendor Number	Part Number	Inside Diameter	Length mm (in)	Outside Diameter	
Global Spiral Ferrule for 4-Spiral Hose						
12.7 (1/2)	8GS1F-4	320042-079	12.7 (1.5)	36.6 (1.44)	34.4 (1.35)	
	Vendor Number	Part Number	Thread Size	Length mm (in)	H Hex	
Male O-Ring Face Plug						
3/8	FS2408-6	320043-001 ⚠	11/16-16	19.05 (.75)	3/4	
Tube O.D.	Vendor Number	Part Number	Thread Size	Length mm (in)	C Hex	Width mm (in)
Male 37° Plug						
3/8	2408-6	320043-002 ⚠	9/16-18	21.41 (.843)	5/8	6.35 (0.25)

⚠WARNING: Cancer and reproductive harm - www.P65Warnings.ca.gov

Komatsu Metric Fittings								
Hose I.D. mm (in.)	Vendor Number	Part Number	Thread Size	H1 mm (in)	H2 mm (in)	"T" Drop mm (in)	Length mm (in)	"C" Cut-Off mm (in)
Female Swivel								
6.4 (1/4)	4G-4FKX	320042-026	M14 x 1.5	14.3	19.0	NA	56.3 (2.22)	30.2 (1.19)
9.5 (3/8)	6G-6FKX	320042-027	M18 x 1.5	17.5	22.2	NA	62.8 (2.47)	34.9 (1.37)
12.7 (1/2)	8G-8FKX	320042-028	M22 x 1.5	20.7	27.0	NA	74.5 (2.93)	37.0 (1.46)
Female Swivel - 90° Bent Tube								
6.4 (1/4)	4G-4FKX90	320042-029	M14 x 1.5	(1/2)	(3/4)	38 (1.5)	69.0 (2.72)	43.0 (1.69)
12.7 (1/2)	8G-8FKX90	320042-030	M22 x 1.5	(13/16)	(11/16)	35 (1.38)	88.0 (3.46)	50.5 (1.99)

⚠WARNING: Cancer and reproductive harm - www.P65Warnings.ca.gov

Note: See Section 9, Tools, for a list of hydraulic tools, including power crimps, dies, pushers, hose cutters, and swager tools.

Rubber Hose



I.D. (in)	Working Pressure (psi)	Minimum Bend Radius inch	SAE Spec.	Vendor Number	Bulk Part Number	10 ft	200 ft	250 ft
Wire Braid High Tensile Steel								
1/4	3000	1.5	100R17	4M3K-XTF	320041-012-01			320041-012
1/4	5000		100R16	4M2T-MTF	320041-009-01			320041-009
1/4	3275	4.0	100R1	4G1	320041-010-01			320041-010
3/8	3000	2.5	100R17	6M3K	320041-002-01			320041-002
3/8	4800	5.0	100R2	6G2	320041-006-01			320041-006
3/8	3000		100R17	6M3K-XTF	320041-007-01			320041-007
3/8	3500		100R16	6M2T	320041-008-01			320041-008
1/2	3000	3.5	100R17	8M3K	320041-003-01			320041-003
1/2	3500	3.5	100R16	8M2T	320041-005-01			320041-005
1/2	4000	3.5	100R19	8M4KL	320041-013-01		320041-013	
5/8	3000	4.0	100R17	10M3K	320041-004-01			320041-004
3/4	3000	4.8	100R17	12M3K	320041-011-01			320041-011
Fiber Braid								
1/2	300	5.0		8LOLA	064100-001*	324100-001-10		
5/8	300	6.0		10LOLA	064100-105			
3/4	750	6.0	100R3	12G3H	064100-018*	324100-018-10		
3/4	300	7.0		12LOLA	064100-037*	324100-037-10		
1	565	8.0	100R3	16G3H	064100-027*	324100-027-10		

*Above 064100-xxx bulk hose is only available in prepackaged lengths shown on the chart.

Crown Aerosols

Heavy-Duty Products for Your Industrial Applications

- High performance products
- Premium formulas designed for industry
- Easy to use

Add to your Crown Parts Consignment program today.



See Section 1 for Service Supplies



VELOCITY™ LOAD WHEELS

The Next Generation of Revolution

- HeatSink™ hub design cools the wheel, preventing material failure.
- 70% lighter than traditional solid steel load wheels.
- Reduces wheel binding from debris.
- Now available in 5" and 6" wheel assemblies.



See Wheels and Tires Section



Section 11

Wheels and Tires

Contents

Wheel Selection Guide	11.02
Wheel Application Guide	11.03
Polyurethane Wheels by Size	11.04
Non-Polyurethane Wheels by Size	11.06
Casters	11.07
Pallet Truck - One Source Casters	11.08
Load Wheel Assemblies w/Shoulder Bearings	11.10
Quick Change Load Wheel	11.10
Triple Load Wheels	11.11
Dual Tandem Load Wheels	11.11
Load Wheel Kits and Complete Wheel Kits	11.12
Bearings	11.16
Tire Application Guide	11.19
Polyurethane Tires by Size	11.20
Hole Tires	11.21
Tire Racks	11.21
Tools	11.21
Rubber Tires by Size	11.22
Sweeper Scrubber Rubber Tires	11.26
Resilient/Pneumatic Tires	11.27
Tubes/Flaps/Rims	11.29
Hubs	11.30
Tire Chains	11.32
Wheel & Tire Cross Reference	11.33

New Items:

Polyurethane Wheels - p. 11.05
Dual Tandem Load Wheels - p. 11.11
Polyurethane Tires - p. 11.20
Rubber Tires - p. 11.22-11.24
Hubs - p. 11.31

Note: 1910.178(q)(5) (1998) of the Occupational Safety and Health Act (OSHA) requires that "All parts of any such industrial truck requiring replacement shall be replaced only by parts equivalent as to safety with those used in the original design."

The installation onto a lift truck of non-certified electronic components may invalidate a truck's UL EE or LPS listing and could pose a safety risk. Customers with UL-listed lift trucks are solely responsible for ensuring compliance with UL for field modifications. The selection of non-OEM parts is made solely by the customer with the awareness that OEM parts are available. Crown Equipment Corporation is unaware of what testing and/or certification, if any, the non-OEM parts have undergone and disclaims all warranties and representations regarding any non-OEM part.

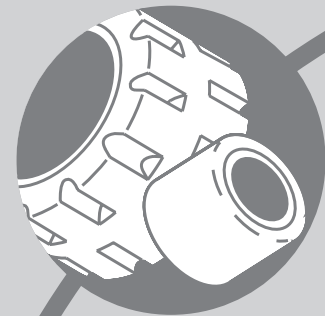

What's on your truck?



Crown Brand

All genuine Crown wheels have an identifier code stamped into the hub and Crown Integrity Parts System™ or Crown One Source Lift Truck Parts® with compound number printed on the wheel.



Wheel Selection Guide Color Reference

If you see one of these wheel colors...



...then your equivalent compound is in this series.

100
SERIES

If you see one of these wheel colors...



...then your equivalent compound is in this series.

200
SERIES

If you see one of these wheel colors...



...then your equivalent compound is in this series.

300
SERIES

If you see one of these wheel colors...



...then your equivalent compound is in this series.

400
SERIES

Note: For additional information contact your local Crown Lift Truck dealer.

3-Step Evaluation Process

Usage Analysis

What is the right amount of wheel and tire usage for your application as it relates to your industry?

Failure Analysis

What is the cause of your wheel and tire failures (e.g., overloading, heat failure, bond failure, floor debris damage)?

Best Value Benchmarking

Have you established a best value solution for your application through benchmarking and tracking?

Wheels

Application Types

Wheel Series	Compound Number	Shore A Hardness	Long Runs/ Heavy Loads	Dock Boards/ Expansion Joints (Chunking)	Metal Chips/ Floor Debris (Flat Spotting)	Wet Conditions	Freezer
100 SERIES Light Duty	These economical 100 Series Light Duty wheel compounds are best suited for light loads and intermittent use.						
	101	93A		○	○	○	○
	102	95A		○	○	○	○
200 SERIES Midrange	The Mid-Range wheels are designed for light to medium loads and short to medium runs.						
	201	83A		●	●	●	●
	204	85A		●	●	●	●
	205	87A		●	●	●	●
300 SERIES High Capacity	For the typical demands of most applications, High Capacity wheels feature compounds designed for high capacities and long runs.						
	301	95A	●	●	●	●	●
	302	93A	●	●	●	●	●
	305	95A	●	●	○	●	●
	306	97A	●	●	●	●	●
400 SERIES Heavy Duty	Heavy Duty wheels are designed for maximum capacities and extreme runs.						
	401	93A	●	●	●		
	402	99A	●				

○ = Good ● = Better ● = Best

Shore A Hardness

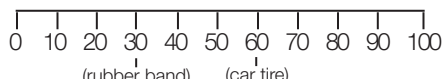

Softer compounds are typically more cut and tear resistant and provide a smoother ride. Harder compounds typically provide improved travel speeds, due to less rolling resistance, and generate less heat.

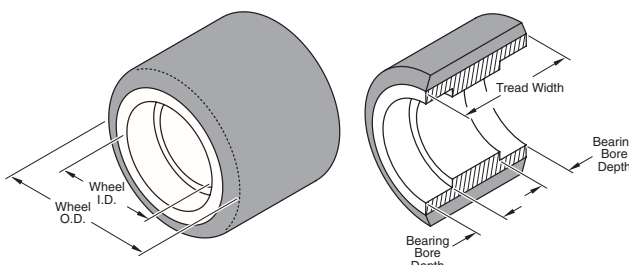

Polyurethane Wheels by Size

Continued ▶

* Indicates assemblies; ‡ Add -88 after compound number for assembly; ^ add-66 after compound number for sealed assembly; +> add -77 after compound for shoulder bearing assembly; < add -V after assembly for Velocity

WHEELS AND TIRES

Wheel O.D.	Tread Width	Wheel I.D.	Bearing Bore Depth	Bearing Ball or Cup	Cone	Crown Base Part No.
1.75						
1.75	1.31	0.760				115385
2.50						
2.50	2.06	1.187				082442*
2.50	2.06	1.187		073894		082443
2.50	2.06	1.187		073894		310443
2.50	3.25	2.170				808981-001*
2.75						
2.75	2.00	1.456	0.472			310325
2.90						
2.90	3.88	1.850				314507
2.90	3.88	1.850	0.55			044506*
2.91						
2.91	3.86	1.850	0.55	065081-019		044507
3.00						
3.00	2.00	1.188				073918
3.00	2.00	2.047	0.63	065081-021		310080
3.00	2.06	1.190	thru			072718*
3.00	3.50	1.850	0.56	311000-005		310189‡
3.00	3.54	1.850	0.55	311000-005		310248
3.00	3.75	1.625	0.44			310083
3.00	4.00	1.850	0.56	311000-005		310182
3.00	6.00	1.780	0.78			310226
3.00	6.00	2.047	1.44	065081-021		310466
3.00	6.50	2.047	1.812	065081-021		310323‡
3.125						
3.125	4.40	2.170	0.8	065081-062		313016
3.23						
3.23	4.33	2.170				808909*
3.25						
3.25	1.57	2.047	0.59	065081-021		310282
3.25	1.75	1.850	0.55	311000-005		310220
3.25	1.88	2.047	0.595			310250
3.25	2.00	2.047	0.59	065081-070		154840‡
3.25	2.00	2.047	0.59			310125‡
3.25	2.25	1.850	0.55	311000-005		310156
3.25	2.44	2.047	0.594	065081-021‡ 065081-070+>		310468‡ +>
3.25	2.63	2.047	1.14	065081-021		310118
3.25	2.88	1.850	0.55	311000-005		310157
3.25	2.88	1.980	Non-Typical	065134	312000-008	310194
3.25	2.88	2.047	0.81	311000-001		075999
3.25	2.88	2.047	0.81	065081-021		076848*
3.25	2.88	2.047	0.59	065081-021		310078
3.25	2.95	1.850	0.63	065081-020		083878
3.25	3.00	2.047	0.81	311000-006		310141
3.25	3.00	2.047	0.66	065081-021		310149
3.25	3.00	2.047	0.59	311000-006		310212
3.25	3.13	2.047	0.975			310241
3.25	3.25	2.047	0.59	065081-021		077084‡
3.25	3.25	2.047	0.59	065081-021		310300
3.25	3.25	2.047	0.83	311000-011		310135
3.25	3.39	2.170				808984-001*
3.25	3.75	1.750	thru			310188
3.25	3.86	1.848	0.63	065081-020		083879
3.25	3.88	1.849	0.63			082283-001*
3.25	3.88	1.849	0.63			082284
3.25	3.88	2.047	0.81	311000-001		310140
3.25	4.00	1.850	0.55	311000-005		310174
3.25	4.00	2.047	0.69			071665
3.25	4.20	2.047	1.18	065081-021		310180
3.25	4.20	2.047	0.59	065081-021		310219
3.25	4.28	2.047	0.83	065081-021		310137
3.25	4.41	2.170	0.80	065081-062		813015

Wheel O.D.	Tread Width	Wheel I.D.	Bearing Bore Depth	Bearing Ball or Cup	Cone	Crown Base Part No.
3.25	4.41	2.170	0.80	065081-062		313015
3.25	4.41	2.170	0.80			813014*
3.25	4.48	2.047	0.58			310316
3.25	4.50	1.575	0.56	311000-004		310185
3.25	4.50	2.047	0.59	065081-021		310244‡
3.25	4.50	2.047	0.71	065081-021		310245*
3.25	4.50	2.047	0.748			310379‡
3.25	4.50	2.160	0.52	065081-062		123603‡
3.25	4.50	2.160	1.03	065081-025		310230
3.25	4.50	2.440	0.66	065081-025		083970
3.25	4.50	2.440	0.66			100029*
3.25	4.71	2.047	0.83	311000-001		310136
3.25	4.84	2.047	0.80			310231
3.25	5.00	2.047	0.59	065081-021		077086‡
3.25	5.50	1.980	0.69	065134	065135	310210
3.25	5.75	2.047	0.83	311000-001		310138
3.25	5.75	2.440	0.69	311000-013		310187
3.25	5.88	2.047	0.59	065081-021		310077
3.25	5.91	2.047	0.59	065081-021		310175
3.25	5.91	2.047	1.18	065081-021 065081-070		310178‡
3.25	5.91	2.047	1.18	065081-021		310478‡
3.25	5.94	2.047	0.59			310251
3.25	5.98	2.047	1.368	065081-071 311000-006		310242‡
3.25	6.00	1.980	0.91	065134	065135	310084
3.25	6.00	2.047	0.59	065081-021		310085
3.25	6.00	2.047	0.778	065081-071		310465
3.25	6.00	2.047	0.81	065081-021		310144‡
3.25	6.00	2.047	1.187	311000-001		310147
3.25	6.00	2.047	1.438			310252‡
3.25	6.25	2.047	0.81	311000-001		310145
3.25	6.38	2.047	0.81	311000-001		310146
3.25	6.38	2.047	1.18	065081-021		310190
3.25	6.38	2.047	1.06			310218
3.25	6.50	1.980	1.18	065134	065135	310093
3.25	6.50	2.047	0.59	065081-021		310000
3.25	6.50	2.047	0.812	065081-051		310243
3.25	6.50	2.047	0.97			310240
3.25	6.50	2.047	1.44	065081-021‡ 065081-070‡		100462‡
3.25	6.50	2.047	1.681			310041
3.25	6.50	2.047	1.807			310342
3.35						
3.35	2.91	2.170				808983-001*
3.38						
3.38	2.25	1.850	0.55	311000-005		310162
3.38	2.63	1.968	0.94			310100
3.38	2.63	2.047	0.67	065081-021		310110
3.38	2.63	2.047	0.76	065081-021		310111
3.38	2.63	2.047	1.14	065081-021		310112
3.38	2.75	2.047	0.81	311000-001		310088
3.38	2.75	2.047	0.91	065081-021		310170
3.38	2.75	2.047	0.61	065081-021		310184
3.38	5.75	2.047	1.45	065081-021		310113
3.50						
3.50	1.88	2.047	0.59	065081-021		310297
3.50	2.00	1.850	0.555			310321
3.50	2.00	2.170	0.84			813128*
3.50	2.00	2.170	0.84	055002-027		813129
3.75						
3.75	1.75	1.653	0.61			310232*
3.94						
3.94	2.01	1.850		805494		806807

Note: Add the compound part number to the base number listed above. Compounds listed on page 11.03. Complete part number format is XXXXXX-XXX.

Continued ▶

Polyurethane Wheels by Size

Continued ▶

* Indicates assemblies; ‡ Add -88 after compound number for assembly; ^ add-66 after compound number for sealed assembly; +> add -77 after compound for shoulder bearing assembly; < add -V after assembly for Velocity

Wheel O.D.	Tread Width	Wheel I.D.	Bearing Bore Depth	Bearing Ball or Cup	Cone	Crown Base Part No.
4.00						
4.00	1.75	2.440	0.81			310298
4.00	1.88	2.440	0.76	370182		310108
4.00	1.92	1.780		065136	065137	310221
4.00	2.00	1.575	0.58	311000-004		310094
4.00	2.00	2.047	0.59	065081-021		081645
4.00	2.00	2.047	0.59			092538*
4.00	2.00	2.170				813081-001*
4.00	2.00	2.440	Non-Typical	311000-013		310176
4.00	2.06	1.189	thru	073894		071894
4.00	2.38	1.938	0.94	312000-001	312000-008	310186
4.00	2.50	1.938	0.94	312000-001	312000-008	310105
4.00	2.50	2.047	0.59	065081-070		083179‡
4.00	2.50	2.047	0.59	065081-070		122893*
4.00	2.50	2.047	0.59	065081-070		310301
4.00	2.50	2.047	0.68			310276
4.00	2.50	2.047	0.68			310376‡
4.00	2.50	2.047	0.68			310277*
4.00	2.50	2.047	0.76	065081-021		310114
4.00	2.50	2.444	0.67			310312
4.00	2.63	2.440	0.77	311000-013		310103
4.00	2.75	1.780	0.72	065136	065137	310193
4.00	2.75	1.938	thru			310098
4.00	2.75	1.938	thru			310152
4.00	2.75	2.047	0.59	065081-021		310099
4.00	2.75	2.440	0.812			310381
4.00	2.75	2.440	0.84	311000-013		310183
4.00	2.88	1.850	0.575			310128
4.00	2.88	2.047	0.59	065081-021		073961
4.00	2.88	2.047	0.75	065081-021		083585‡
4.00	2.88	2.047	0.59			091163*
4.00	2.88	2.047	0.75			310343 
4.00	2.88	2.328	0.83	065105	065106	310153
4.00	2.88	2.440	0.672			310235
4.00	2.88	2.440	0.75	311000-013		310142
4.00	2.88	2.440	0.98	311000-013		310181
4.00	2.95	2.170				813080-001*
4.00	3.25	2.170				808982-001*
4.00	3.25	2.170				808982-002*
4.00	3.62	2.047	0.59	065081-021		310158
4.00	3.62	2.047	0.59	065081-021		310258
4.00	3.62	2.047	0.625	065081-021		310253
4.00	3.63	2.440	0.77	311000-013		310106
4.00	4.12	2.047	0.75	065081-021		088628‡
4.00	5.00	2.440	0.63			084944
4.92						
4.92	2.44	2.170	0.80			813130*
5.00						
5.00	1.13	2.047	Non-Typical	065081-021		310168
5.00	1.50	0.625	thru			071892*
5.00	1.75	2.440	0.667	311000-007		310360*
5.00	2.00	1.188	thru			073325*
5.00	2.00	1.850	0.551			310233*
5.00	2.00	2.047	0.59	065081-021		310159
5.00	2.00	2.440	Non-Typical	311000-013		310173
5.00	2.50	1.850	0.675			310126
5.00	2.50	1.938	0.94	312000-001	312000-006	310139
5.00	2.63	2.835	0.78			310104
5.00	2.87	1.780	0.80	065136	065137	310195
5.00	2.88	2.047	0.63	311000-011		310095
5.00	2.88	2.047	0.59	311000-006		310164‡<
5.00	2.88	2.328	0.83	065105	065106	310151
5.00	2.88	2.440	0.67			310079‡^<

Wheel O.D.	Tread Width	Wheel I.D.	Bearing Bore Depth	Bearing Ball or Cup	Cone	Crown Base Part No.
5.00	2.88	2.440	0.83	065081-057‡ 065081-005^		115032‡^
5.00	2.88	2.440	0.83	365181-057-01		315032+>
5.00	2.88	2.440	0.78	311000-013		310133
5.00	2.88	2.440	0.75	065081-057		310143
5.00	2.88	3.149	0.98	065081-008		083586
5.00	2.88	3.149	0.98			113016*
5.00	2.88	3.149	0.98			310586
5.00	3.00	2.834	0.74	365081-006		310115
5.00	3.00	3.250	1.78			310229
5.00	3.63	2.440	0.67	065081-057		310160‡<
5.00	3.63	2.835	0.76	365081-006		310102
5.00	3.75	2.835	0.74			310116
5.00	3.88	2.050	0.60	065081-021		312360
5.00	3.88	2.440	0.67			310234‡^<
5.00	3.94	2.834	0.748			310380
5.00	4.00	2.440	0.63	065081-024		310259
5.00	4.12	2.440	0.67			310123‡^<
5.00	4.12	2.440	0.83	065081-057‡ 065081-005^		115033‡^
5.00	4.12	2.440	0.83	365181-057-01		315033+>
5.00	4.12	3.149	0.98	065081-008		083587
5.00	4.12	3.149	0.98			113017*
5.50						
5.50	2.38	2.047	0.59			310288
5.91						
5.91	2.20	1.850	0.55			805535
5.91	2.36	2.050	0.59			812015*
5.91	2.36					802745*
6.00						
6.00	2.00	2.017	0.59			310319
6.00	2.00	2.440	0.63			310096
6.00	2.00	3.149	0.83	065081-007		090748
6.00	2.00	3.149	0.83			100956*
6.00	2.40	1.980	0.88	065134	065135	310082
6.00	2.50	1.938	0.94	312000-001	312000-006	310166
6.00	2.50	2.328	1.97	065105 and 071545	065106	310161
6.00	2.75	3.149	0.83	065081-008		082021‡
6.00	2.75	3.149	0.83	365081-008-02		382021+>
6.00	2.75	3.149	0.83	065081-008		310305‡
6.00	2.88	3.150	0.80	065081-008‡ 065081-085^		125069‡^
6.00	2.88	3.150	0.80			310313
6.00	2.88	3.150	0.80	365081-008-01		325069+>
6.00	3.00	1.780	0.81	065136	065137	310171
6.00	3.00	1.938	0.97	065136	065137	310196
6.00	3.00	1.969				310225
6.00	3.00	2.047	0.60			310132
6.00	3.00	2.047	0.67	065081-021		310177
6.00	3.00	2.440	0.755	065081-057		310324
6.00	3.00	2.440	0.78	311000-007		310134
6.00	3.00	2.440	0.68	311000-007		310167
6.00	3.00	2.440	0.84	312000-003	312000-011	310191
6.00	3.25	2.046	0.593			310281
6.00	3.63	2.440	0.67	311000-007		310172‡^<
6.00	3.89	3.149	0.828			310239
6.00	3.88	2.835	0.74	365081-006		310222
6.00	3.94	2.875	1.22	312000-004	312000-012	310154
6.00	4.00	2.835	1.17			310109
6.00	4.00	2.835	0.67			310169
6.00	4.12	3.149	0.98	065081-008‡ 065081-085^		125070‡^
6.00	4.12	3.149	0.98	365081-008-01		325070‡^+><

WHEELS AND TIRES

Note: Add the compound part number to the base number listed above.  New part
Compounds listed on page 11.03. Complete part number format is XXXXXX-XXX.

6.00 O.D. Continued ▶

Polyurethane Wheels by Size

* Indicates assemblies; † Add -88 after compound number for assembly; ^ add-66 after compound number for sealed assembly; +> add -77 after compound for shoulder bearing assembly; < add -V after assembly for Velocity

Wheel O.D.	Tread Width	Wheel I.D.	Bearing Bore Depth	Bearing Ball or Cup	Cone	Crown Base Part No.
6.00	4.25	3.149	0.83	065081-008		082020†
6.00	4.25	3.149	0.83	365081-008-01		382020+>
6.88						
6.88	2.00	2.835	0.97			310163
7.00						
7.00	1.95	1.845	0.55	065081-020		120737
7.00	1.95	1.845	0.55			120739*
7.00	2.00	1.850				314496
7.00	2.00	1.850	0.55			044495*
7.00	2.00	1.850	0.55	065081-020		044496
7.00	2.50	2.326	Non-Typical	065105	065106	310155
7.00	2.50	2.328	Non-Typical	065105	065106	310107
7.00	2.75	1.980		065134	065135	310227
7.00	2.86	2.047	Non-Typical	065081-021		310087
7.00	3.00	2.047	0.75			310287†
7.00	4.00	2.440	0.63			310292*
7.00	4.00	2.440	0.84	312000-003	312000-011	310192
7.09						
7.09	1.97	1.850	0.55	065081-018		818275-101*
7.09	1.97	1.850	0.55	055002-023		818275-201*
7.09	1.97	1.850	0.55	065081-020		818270
7.87						
7.87	2.00	1.850				041269
7.88						
7.88	2.48	2.047	Non-Typical	065081-021		310091
8.00						
8.00	2.00	1.750				310089
8.00	2.00	1.980	0.81	065134	065135	310148
8.00	2.00	1.998	thru			310097
8.00	2.00	2.047	0.60	065081-021		310090
8.00	2.00	2.047	0.67	065081-021		310092
8.00	2.00					082274-001*
8.00	2.00	2.044		065081-021		083834-001
8.00	2.00	2.438		065081-025		083834-002
8.00	2.50	7.600	2.64			310130
8.00	3.75	3.150	0.83	065081-008		080915†
8.00	4.00	2.440	0.66	065081-025		310179†
8.00	4.00	2.835	0.91	065081-067		127723†
8.50						
8.50	2.66	2.754	Non-Typical			310131
8.50	2.69	2.754	2.5			310129
8.50	2.69	2.760	Non-Typical	065081-031		132359
9.00						
9.00	5.00	3.543	0.79			310117
10.00						
10.00	3.00	2.325				311520
10.00	3.00	2.325				311521*
10.00	3.00	2.325				081520*
11.22						
11.22	3.94					810574-001
13.00						
13.00	3.94	2.950	1.38			807544

Note: Add the compound part number to the base number listed above. Compounds listed on page 11.03. Complete part number format is XXXXXX-XXX.

Wheel O.D.	Tread Width	Wheel I.D.	Bearing Bore Depth	Bearing Ball or Cup	Cone	Crown Base Part No.
13.00	3.94	2.950				810583
13.00	3.94	2.950				E-810601*
14.25						
14.25	8.00	9.980				133753
14.25	8.00	9.980				157101*

Non-Polyurethane Wheels by Size

Wheel O.D.	Tread Width	Wheel I.D.	Bearing Bore Depth	Bearing Ball	Type	Crown Base Part No.
2.88						
2.88	2.06	1.189	thru		Steel	072426*
2.88	2.06				Steel	104633
2.90						
2.90	3.88	1.850	0.55	065081-019	Nylon	044508
2.91						
2.91	3.84	1.850	0.56	065081-019	Steel	120738
2.91	3.84	1.850	0.56		Steel	120740*
2.91	3.86	1.850	0.55		Nylon	044506-102*
3.25						
3.25	3.25	2.047	0.59	065081-021	Nylon	082740
3.25	3.88	1.849	0.63		Nylon	082283-002*
3.25	3.88	1.849	0.63		Steel	082283-003*
3.25	3.88	1.849	0.63	065081-020	Nylon	082285
3.25	3.88	1.849	0.63	065081-020	Steel	082286
3.25	4.50	2.440	0.66	065081-025	Nylon	083968
3.25	4.50	2.440	0.66	065081-025	Steel	083969
3.25	5.00	2.047	0.63	065081-021	Steel	082743
4.00						
4.00	2.06	1.189	thru		Steel	071426
4.00	2.06	1.189	thru		Phenolic	071893
4.00	2.06	1.189	thru		Phenolic	073895
5.00						
5.00	1.62	0.750	thru		Steel	071916*
5.00	2.00	1.188	thru		Phenolic	073324*
5.00	2.12	0.750	thru		Phenolic	071891
5.00	2.12	0.750	thru		Steel	073602*
5.50						
5.50	5.00	2.190			Rubber	370355
7.00						
7.00	2.00	1.850	0.55	065081-020	Nylon	044497
7.00	4.00	2.441			Rubber	350067
7.00	5.00	3.150	thru		Rubber	077533*
7.00	5.00				Rubber	083167*
7.09						
7.09	1.97	1.850	0.55	065081-020	Nylon	818271
7.09	1.97	1.850	0.55	065081-018	Nylon	818275-102*
7.09	1.97	1.850	0.55	055002-023	Nylon	818275-202*
7.09	1.97	1.850	0.55	065081-018	Rubber	818275-103*
7.09	1.97	1.850	0.55	055002-023	Rubber	818275-203*



Casters for use in a wide range of industries.

Commonly found on platform trucks, shop carts and industrial equipment.

- Durable
- Phenolic
- Provides floor protection
- Swivel and Rigid Options
- Not recommended for use in wet environments

Standard and Economy Casters

Wheel	Wheel Size	Type	Overall Height	Capacity	Standard Caster ASM Part Number	Economy Caster ASM Part Number	Wheel Only** Part Number
Phenolic	4" x 2"	Swivel	5.625"	800 lbs.	310330-041	310329-041	310331-040
		Rigid	5.625"	800 lbs.	310330-042	310329-042	
	5" x 2"	Swivel	6.5"	1,000 lbs.	310330-051	310329-051	310331-050
		Rigid	6.5"	1,000 lbs.	310330-052	310329-052	
	6" x 2"	Swivel	7.25" or 7.5"	1,200 lbs.	310330	310329*	310331
		Rigid	7.25" or 7.5"	1,200 lbs.	310330-062	310329-062*	
	8" x 2"	Swivel	9.5"	1,250 lbs.	310330-081	310329-081	310331-080
		Rigid	9.5"	1,250 lbs.	310330-082	310329-082	

*Caster Height 7.5"

**Phenolic Wheel w/Roller Bearing/Spanner Bushing (1/2" ID)



Description	Part Number
Axle for Casters/Wheels	310331-000

Note: You need to add the compound part number to the base number listed above. See compounds listed on page 11.03 for the dash number. Complete part number format is XXXXX-XXX.

Pallet Truck - One Source Casters

Features

- 3 simple designs fit most manufacturers' pallet trucks.
- Poly-block creates a dampening effect to eliminate rocking and provide greater stability.
- Adjustable height eliminates the need for spacer plates and shims.

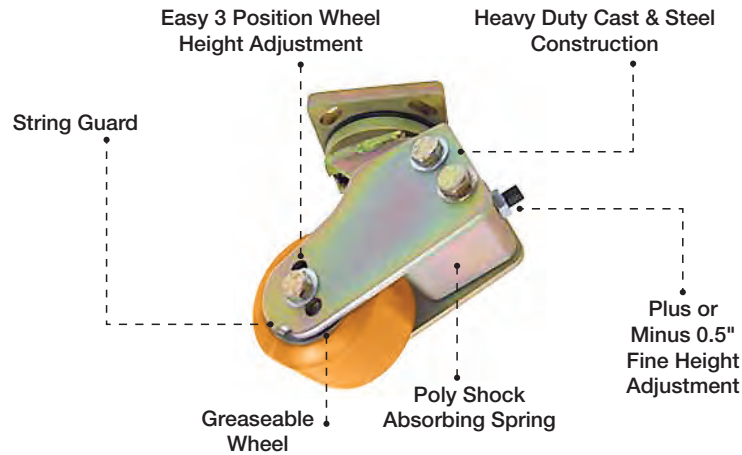

One Source Assembly Casters

Part Number	Manufacturer Number	Asm. Caster Height	Turning Radius	Centered or Offset Swivel	Load Wheel Size	Base Plate Size	Slots or Holes	Bolt Pattern
310273-306	STR2000FS*	7.5	4.1875	Centered	4x2.5	4x4.75	Slots	3.004x3.992 and 2.287x3.275
310273-306-CR	STR2000CR2 FS*	7.5	4.1875	Centered	4x2.5	5x5	2-sets of Holes	2.625x3.625 and 4.125x4.125
310273-306-BL	STR2001BL FS*	7.5	3.875	Centered	4x2.5	4x4.75	Holes	2.756x3.386
310273-306-HY	STR2000HY FS*	7.5	4.1875	Centered	4x2.5	4x4.50	Threaded Holes	2.795x3.295
310273-306-RA	STR2000RA FS*	7.625	4.1875	Offset	4x2.5	5x6	Slots	3x5 and 2.625x4.5
310274-306	STR3000 FS*	9.125	4.1875	Centered	4x2.5	5x7	Slots	3.328x5.269 and 2.731x4.672
310275-306	STR4001 FS*	8.375	4.1875	Centered	4x2.5	5x5.375	Holes	4x4
310260-306-BR	STR4164	8	4.684	Offset	6x3	6.25x4.5	Holes	5.25x3.375
310262-306-RA	STR3200FS*	7.5	4.1875	Centered	4x2.5	5x7	Slots	3.328x5.269 and 2.731x4.672
310279-306-BR	STR6110FS*	9.875	4.25	Centered	5x2.5	6.25x4.5	Slots	5.25x3.375 and 4.938x2.438
310289-306	STR5263FS*	8.85	4.44	Centered	4x2.5	5x7	Holes	5.25x3.375

*All -306 Assemblies come with a greaseable pivot and wheel axle that are made to withstand extreme wash down applications as a Food Service option.

Note: See cross references on next page.

Pallet Truck - One Source Casters Cross Reference

Crown Part No.	OE Number	OEM Name
310274-306	4972078	Allis Chalmers/Tusk
310274-306	74970278	Allis Chalmers/Tusk
310273-306	127520	Baker
310273-306	138071	Baker
310273-306	138073	Baker
310273-306	138075	Baker
310273-306	139312	Baker
310273-306	152865	Baker
310273-306	153858	Baker
310273-306	993465	Baker
310273-306	993994	Baker
310279-306-BR	27835-003	Barrett
310279-306-BR	37194-003S	Barrett
310279-306-BR	37194-006	Barrett
310274-306	43380-FS000	Barrett
310274-306	43380-FS001	Barrett
310274-306	43380-FS002	Barrett
310289-306	43380-FS004	Barrett
310260-306-BR	43380-FS400	Barrett
310273-306	1009237	Caterpillar
310273-306	1009299	Caterpillar
310273-306	1202032	Caterpillar
310275-306	1779711	Clark
310275-306	2314632	Clark
310275-306	2314636	Clark
310275-306	2743452	Clark
310275-306	2779621	Clark
310275-306	2786022	Clark
310273-306	323772	Hyster
310273-306-HY	346201	Hyster
310273-306	346202	Hyster
310273-306	351314	Hyster
310273-306	826120	Hyster
310273-306	826275	Hyster
310273-306	2007884	Hyster
310273-306-HY	2079240	Hyster
310274-306	2308415	Hyster
310273-306	3246410	Hyster

Crown Part No.	OE Number	OEM Name
310273-306	LC2000	Larcaster
310273-306-CR	LC2400	Larcaster
310273-306	LC2500	Larcaster
310274-306	LC3001	Larcaster
310274-306	LC3501	Larcaster
310275-306	LC4001	Larcaster
310275-306	LC4501	Larcaster
310273-306-BL	154148	Linde/Baker
310273-306	NA067022	Mitubishi
310289-306	43380-FS004	Nissan
310273-306	27332	Prime Mover
310273-306	27675	Prime Mover
310273-306	27849	Prime Mover
310273-306	139312	Prime Mover
310273-306-RA	1082408	Raymond
310273-306-RA	59048553	Raymond
310262-306-RA	671-012	Raymond
310273-306	671-017	Raymond
310273-306	671-023	Raymond
310273-306	671-024	Raymond
310273-306	671-025	Raymond
310273-306	671-026	Raymond
310273-306-RA	671-042	Raymond
310273-306	0951-C01	RVI
310273-306	00590-00027-71	Toyota
310274-306	00590-01556-71	Toyota
310274-306	00590-01662-71	Toyota
310274-306	00590-39633-71	Toyota
310273-306	42660-81100-71	Toyota
310273-306	150120033	Yale
310274-306	516012603	Yale
310274-306	518782600	Yale
310274-306	520583002	Yale
310274-306	524153612	Yale
310273-306-HY	524244220	Yale
310273-306-HY	524267533	Yale
310274-306	720465006	Yale

Load Wheel Assemblies w/Shoulder Bearings

Crown Assembly Part Number	Wheel O.D.	Tread Width	Wheel I.D.	Bearing		Load Wheel
				Bore Depth	Bearings	
315032-302-77	5.00	2.88	2.440	0.83	365181-057-01	115032-302
315032-305-77	5.00	2.88	2.440	0.83	365181-057-01	115032-305
315032-306-77	5.00	2.88	2.440	0.83	365181-057-01	115032-306
315032-401-77	5.00	2.88	2.440	0.83	365181-057-01	115032-401
315033-302-77	5.00	4.12	2.440	0.83	365181-057-01	115033-302
315033-305-77	5.00	4.12	2.440	0.83	365181-057-01	115033-305
315033-306-77	5.00	4.12	2.440	0.83	365181-057-01	115033-306
315033-401-77	5.00	4.12	2.440	0.83	365181-057-01	115033-401
325070-302-77	6.00	4.12	3.149	0.98	365081-008-01	125070-302
325070-305-77	6.00	4.12	3.149	0.98	365081-008-01	125070-305
325070-401-77	6.00	4.12	3.149	0.98	365081-008-01	125070-401
325069-201-77	6.00	2.88	3.149	0.80	365081-008-01	125069-201
325069-301-77	6.00	2.88	3.149	0.80	365081-008-01	125069-301
325069-302-77	6.00	2.88	3.149	0.80	365081-008-01	125069-302
325069-305-77	6.00	2.88	3.149	0.80	365081-008-01	125069-305
325069-306-77	6.00	2.88	3.149	0.80	365081-008-01	125069-306
325069-401-77	6.00	2.88	3.149	0.80	365081-008-01	125069-401
382021-201-77	6.00	2.75	3.149	0.83	365081-008-02	082021-201
382021-301-77	6.00	2.75	3.149	0.83	365081-008-02	082021-301
382021-302-77	6.00	2.75	3.149	0.83	365081-008-02	082021-302
382021-305-77	6.00	2.75	3.149	0.83	365081-008-02	082021-305
382021-306-77	6.00	2.75	3.149	0.83	365081-008-02	082021-306
382021-401-77	6.00	2.75	3.149	0.83	365081-008-02	082021-401
382020-201-77	6.00	4.25	3.149	0.83	365081-008-02	082020-201
382020-302-77	6.00	4.25	3.149	0.83	365081-008-02	082020-302
382020-306-77	6.00	4.25	3.149	0.83	365081-008-02	082020-306



- Reduce or eliminate the spacers needed for installation.
- Reduce labor time and costs.

Quick Change Load Wheel

Reach Truck Quick Change Load Wheel Kits

Replace a set of load wheels in 2-3 minutes anywhere in your facility.

- Increase truck uptime
- Reduce maintenance labor expense
- No jack required



Quick Change Outrigger Kit

Part Number	Size	Note	Bearing
151701-301	5x2.88	115032-301-66 load wheel assemblies included	065081-005
151702-302	5x4.12	115033-302-66 load wheel assemblies included	065081-005
151703-301	6x2.88	125069-301-66 load wheel assemblies included	065081-085
151704-302	6x4.12	125070-302-66 load wheel assemblies included	065081-085

Your truck must already have standard bolt on outriggers to install this kit.

▲ **WARNING:** Cancer - www.P65Warnings.ca.gov

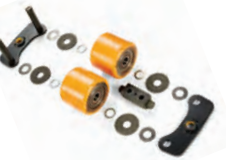

Quick Change Load Wheel Spare Kit Assembly (less outriggers)

Part Number	Size	Note	Bearing
151705-301	5x2.88	115032-301-66 load wheel assemblies included	065081-005
151706-302	5x4.12	115033-302-66 load wheel assemblies included	065081-005
151707-301	6x2.88	125069-301-66 load wheel assemblies included	065081-085
151708-302	6x4.12	125070-302-66 load wheel assemblies included	065081-085

▲ **WARNING:** Cancer - www.P65Warnings.ca.gov



Your truck must have quick change outriggers installed to use this kit.

Quick Change Load Wheel Installation Tool

Part Number	Size
150192	2.88"
150193	4.12"

Notes: Each kit is for a complete truck assembly (both sides). Order Wheel Part numbers that end in -66 for the wheel assemblies with sealed bearings. See "Polyurethane Wheels by Size" for other load wheel compound options.

Triple Load Wheels

YOUR FLAT SPOTTING SOLUTION



Independent wheel rotation to reduce coning and increase load wheel life

Crown Three Wheel Kit

Part Number	Description	Note
154840-101	Wheel 3.25x2x2.047x0.59	Wheel Only
154840-201	Wheel 3.25x2x2.047x0.59	Wheel Only
154840-205	Wheel 3.25x2x2.047x0.59	Wheel Only
154840-301	Wheel 3.25x2x2.047x0.59	Wheel Only
154840-302	Wheel 3.25x2x2.047x0.59	Wheel Only
154840-305	Wheel 3.25x2x2.047x0.59	Wheel Only
154840-306	Wheel 3.25x2x2.047x0.59	Wheel Only
154840-401	Wheel 3.25x2x2.047x0.59	Wheel Only
154840-101-88	Wheel Assembly 3.25x2x2.047x0.59	Wheel and Bearings - greaseable
154840-201-88	Wheel Assembly 3.25x2x2.047x0.59	Wheel and Bearings - greaseable
154840-205-88	Wheel Assembly 3.25x2x2.047x0.59	Wheel and Bearings - greaseable
154840-301-88	Wheel Assembly 3.25x2x2.047x0.59	Wheel and Bearings - greaseable
154840-302-88	Wheel Assembly 3.25x2x2.047x0.59	Wheel and Bearings - greaseable
154840-305-88	Wheel Assembly 3.25x2x2.047x0.59	Wheel and Bearings - greaseable
154840-306-88	Wheel Assembly 3.25x2x2.047x0.59	Wheel and Bearings - greaseable
154840-401-88	Wheel Assembly 3.25x2x2.047x0.59	Wheel and Bearings - greaseable
154838	Triple Load Wheel Axle	Axle with 3 holes

Raymond 939-WHL Three Wheel Kit

Part Number	Description	Note
310250-101	Wheel 3.25x1.88x2.047x0.595	Wheel Only
310250-102	Wheel 3.25x1.88x2.047x0.591	Wheel Only
310250-204	Wheel 3.25x1.88x2.047x0.591	Wheel Only
310250-205	Wheel 3.25x1.88x2.047x0.595	Wheel Only
310250-301	Wheel 3.25x1.88x2.047x0.595	Wheel Only
310250-302	Wheel 3.25x1.88x2.047x0.588	Wheel Only
310250-305	Wheel 3.25x1.88x2.047x0.595	Wheel Only
310250-306	Wheel 3.25x1.88x2.047x0.591	Wheel Only
310250-301-INNER	Wheel 3.25x1.88x2.047x0.595 I	1 inner wheel with bearings - greaseless
310250-301-OUTER	Wheel 3.25x1.88x2.047x0.595 O	1 outer wheel with bearings - greaseless
310250-301-KIT	Wheel 3.25x1.88x2.047x0.595	3 wheels, all bearings - greaseless
310250-302-KIT	Wheel 3.25x1.88x2.047x0.588	3 wheels, all bearings - greaseable
310250-302-KITGL	Wheel 3.25x1.88x2.047x0.588 GL	3 wheels, all bearings - greaseless
310250-306-KIT	Wheel 3.25x1.88x2.047x0.591	3 wheels, all bearings - greaseable
310250-306-KITGL	Wheel 3.25x1.88x2.047x0.591 GL	3 wheels, all bearings - greaseless
310250-409-KIT	Wheel 3.25x1.88x2.047x0.595	3 wheels, all bearings - greaseable
370119	Triple Load Wheel Axle	Axle with 3 holes

Dual Tandem Load Wheels



Dual Tandem Load Wheels PC, PE, PR & PW (9" & 10" forks only)

Part Number	Description	Note
310468-301	Wheel 3.25x2.44x2.047x.594	Wheel only
310468-302	Wheel 3.25x2.44x2.047x.594	Wheel only
310468-306	Wheel 3.25x2.44x2.047x.594	Wheel only
310468-401	Wheel 3.25x2.44x2.047x.594	Wheel only
310468-402	Wheel 3.25x2.44x2.047x.594	Wheel only
310468-302-77	Wheel Assembly 3.25x2.44x2.047x.594	Wheel and Bearings - greasable
310468-302-88	Wheel Assembly 3.25x2.44x2.047x.594	Wheel and Bearings - greasable
310468-401-88	Wheel Assembly 3.25x2.44x2.047x.594	Wheel and Bearings - greasable
H47531-502	Dual Tandem Wheel Axle	Axle with 2 Holes

**Manual Pallet Jack
Pre-packaged Wheel Kits**



Brand	Model	Load Wheel Kit Crown Part No.**	Load Wheels OD x W	Complete Wheel Kit Crown Part No.**	Steer Wheels OD x W
American Lifts	Little Mule	310700-120-KIT*	3" x 2.50"	310701-120-KIT*	7" x 2"
Atlas	EZ	310700-143-KIT*	2.75" x 3.75"	310701-107-KIT*	7" x 2"
	EZV	310700-119-KIT*	3" x 3.70"	310701-121-KIT*	7" x 2"
	Zenith (Type 9)	310700-119-KIT*	3" x 3.70"	310701-121-KIT*	7" x 2"
Big Joe	ALT50	310700-119-KIT*	3" x 3.70"	310701-121-KIT*	7" x 2"
Bishamon	BS55	310700-134-KIT	2.75" x 3.75"		
BT	L2000/L2300	310700-100-KIT	3.25" x 3.625"	310701-100-KIT	7" x 2"
	L2000-U/L2300-U	310700-101-KIT	2.90" x 3.75"	310701-101-KIT	7" x 2"
	LHM 230	310700-101-KIT	2.90" x 3.75"	310701-101-KIT	7" x 2"
Clark	CGH23/25	310700-143-KIT*	2.75" x 3.75"	310701-107-KIT*	7" x 2"
	CJ55	310700-119-KIT*	3" x 3.70"	310701-121-KIT*	7" x 2"
Dayton	2ZE57	310700-119-KIT*	3" x 3.70"	310701-121-KIT*	7" x 2"
	2ZE60	310700-119-KIT*	3" x 3.70"	310701-121-KIT*	7" x 2"
	3KR84	310700-122-KIT*	3" x 3.75"		
	4YX96	310700-143-KIT*	2.75" x 3.75"	310701-107-KIT*	7" x 2"
	4YX97	310700-119-KIT*	3" x 3.70"	310701-121-KIT*	7" x 2"
	5LA79	310700-164-KIT*	3" x 3.70"	310701-121-KIT*	7" x 2"
Doosan	AC25	310700-119-KIT*	3" x 3.75"	310701-141-KIT*	7" x 2"
	HPT28	310700-119-KIT*	3" x 3.75"	310701-142-KIT*	7" x 2"
Eagle	Eagle 55	310700-164-KIT*	3" x 3.70"	310701-111-KIT*	7" x 2"
EP	EP55II	310700-143-KIT*	2.75" x 3.75"	310701-107-KIT*	7" x 2"
Global	334475	310700-144-KIT*	2.75" x 3.37"	310701-144-KIT*	7" x 2"
Harbor Freight	39939	310700-122-KIT*	3" x 3.75"		
Hu-lift	BST	310700-144-KIT*	2.75" x 3.37"		
	HP25L	310700-145-KIT*	2.75" x 3.75"	310701-145-KIT*	7" x 2"
	HSP	310700-163-KIT*	3" x 2"		
Hyster	HY55	310700-119-KIT*	3" x 3.70"	310701-121-KIT*	7" x 2"
JET	A	310700-103-KIT*	3" x 2.75"		
	J	310700-105-KIT*	2.75" x 3.75"		
	L	310700-104-KIT*	2.75" x 2.875"		
	PTW	310700-147-KIT*	3" x 3.75"	310701-147-KIT*	7" x 2"
	PTX	310700-106-KIT*	2.50" x 4"	310701-106-KIT*	7" x 2"
	W	310700-143-KIT*	2.75" x 3.75"	310701-107-KIT*	7" x 2"
Jungheinrich	AM2200	310700-117-KIT*	3" x 3.75"	310701-117-KIT+*	6.75" x 2"
King	KJ 2002	310700-148-KIT*	3" x 2.75"		
Lift-Rite/Big Joe	CF & L30	310700-123-KIT*	1.75" x 3" Steel		
	L50	310700-122-KIT*	3" x 3.75"	310701-108-KIT	8" x 2"
	L50 4 Way (CHEP)	310700-127-KIT*	1.75" x 3" Steel		
	L50 Mini	310700-126-KIT*	2" x 3" Steel		
	L55	310700-109-KIT*	3" x 3.75"	310701-109-KIT+*	8" x 2"
	LCR55 Titan Series	310700-110-KIT	3" x 3.75"	310701-110-KIT	7" x 2"
	LCU & LCU4W	310700-127-KIT*	1.75" x 3" Steel		
	LR0655	310700-109-KIT*	3" x 3.75"	310701-109-KIT+*	8" x 2"
	LRP 5000	310700-101-KIT	2.90" x 3.75"	310701-101-KIT	7" x 2"
	"Titan LCM50, LCU50, LCU4W, LCM4W Frame"	310700-124-KIT*	2" x 3"		
Mighty Lift	CFA/ ML 55	310700-112-KIT*	3" x 3.70"	310701-111-KIT*	7" x 2"
	ML 55-II & ML55L	310700-112-KIT*	3" x 3.70"	310701-112-KIT*	7" x 2"
Mobile	ECO I-55	310700-115-KIT*	3" x 3.50"	310701-115-KIT*	7" x 2"
	ECO I-55 (2009 & Later)	310700-119-KIT*	3" x 3.70"	310701-121-KIT*	7" x 2"
	ELP55	310700-164-KIT*	3" x 3.70"	310701-121-KIT*	7" x 2"
	EMSL22	310700-163-KIT*	3" x 2"		

Load Wheels are Ultra-Poly 70D

Steer Wheels are Poly 95A

+Steer wheels are nylon.

*Includes corrosive-resistant surface finish axles and hardware.

**Load Wheel Kits include Load Roller Assemblies w/Bearings, Axles, and Fasteners.

**Complete Wheel Kits include Load Roller Assemblies w/Bearings, Steer Wheel Assemblies w/Bearings, Axles, and Fasteners.

**Manual Pallet Jack
Pre-packaged Wheel Kits** (Continued)



Brand	Model	Load Wheel Kit Crown Part No.**	Load Wheels OD x W	Complete Wheel Kit Crown Part No.**	Steer Wheels OD x W
Mobile	ML55	310700-114-KIT	3" x 3.50"	310701-113-KIT	7" x 2"
	MLX55	310700-114-KIT	3" x 3.50"	310701-114-KIT	7" x 2"
Multiton	J, M, & TM	310700-116-KIT*	3" x 3.75"	310701-116-KIT*	8" x 2"
	T45	310700-103-KIT*	3" x 2.75"		
	T50	310700-103-KIT*	3" x 2.75"		
Nobile Lift	TM55	310700-117-KIT*	3" x 3.75"	310701-117-KIT+*	6.75" x 2"
	AC20 & AC25	310700-119-KIT*	3" x 3.70"	310701-121-KIT*	7" x 2"
	DF	310700-164-KIT*	3" x 3.70"	310701-121-KIT*	7" x 2"
	DF25	310700-164-KIT*	3" x 3.70"	310701-121-KIT*	7" x 2"
Pallet Mule (Wesley)	AA5000, AA5500	310700-129-KIT*	2.90" x 4"	310701-129-KIT*	7" x 2"
Pramac	GS22	310700-162-KIT*	3.12" x 3.25"		
Raymond	RJ50	310700-101-KIT	2.90" x 3.75"	310701-101-KIT	7" x 2"
	RJ50N	310700-101-KIT	2.90" x 3.75"	310701-101-KIT	7" x 2"
Rol-Lift	T&E Series 2.9	310700-165-KIT	3" x 3.75"		
	T&E Series 3.25	310700-166-KIT	3.25" x 3.75"		
Total Source	HJ55	310700-164-KIT*	3" x 3.70"	310701-121-KIT*	7" x 2"
	HJ5500	310700-164-KIT*	3" x 3.70"	310701-121-KIT*	7" x 2"
	TSP5500	310700-164-KIT*	3" x 3.70"	310701-112-KIT*	7" x 2"
Toyota	HPT25	310700-101-KIT	2.90" x 3.75"	310701-101-KIT	7" x 2"
	HPT28U	310700-101-KIT	2.90" x 3.75"	310701-101-KIT	7" x 2"
U-Line	H-1043, H-1366, H-1193 & H-1484	310700-154-KIT*	3" x 3.70"	310701-121-KIT*	7" x 2"
	H-1785	310700-163-KIT*	3" x 2"		
	H-2186	310700-161-KIT*	3" x 3.70"	310701-160-KIT+	7" x 2"
	H-2507	310700-163-KIT*	3" x 2"		
	H-2708, H-2900, & H-3045	310700-155-KIT*	3" x 3.75"	310701-155-KIT*	7" x 2"
	H-4123	310700-164-KIT*	3" x 3.70"	310701-111-KIT*	7" x 2"
	H-5441	310700-163-KIT*	3" x 2"		
	H-5442	310700-163-KIT*	3" x 2"		
Ultra	UL 5500	310700-130-KIT*	3" x 3.75"	310701-130-KIT*	7" x 2"
Valu-Jack (Relius)	VJ 5500/6600	310700-119-KIT*	3" x 3.70"	310701-121-KIT*	7" x 2"
Vestil	L220DC	310700-163-KIT*	3" x 2"		
	L270DC	310700-163-KIT*	3" x 2"		
	PM5	310700-122-KIT*	3" x 3.75"		
WanMax	W55	310700-156-KIT*	2.75" x 3.75"	310701-156-KIT*	7" x 2"
Wesco	272136	310700-157-KIT*	3" x 3.37"		
	272746	310700-157-KIT*	3" x 3.37"	310701-158-KIT*	8" x 2"
	272744	310700-157-KIT*	3" x 3.37"	310701-158-KIT*	8" x 2"
	272748	310700-157-KIT*	3" x 3.37"	310701-158-KIT*	8" x 2"
	CPI	310700-119-KIT*	3" x 3.70"	310701-121-KIT*	7" x 2"
	CPII	310700-119-KIT*	3" x 3.75"		
	NTEHL27	310700-163-KIT*	3" x 2"		
	TEHL21	310700-163-KIT*	3" x 2"		
TEHL27	310700-163-KIT*	3" x 2"			
Yale	TSHL20-33	310700-163-KIT*	3" x 2"		
	YA55	310700-164-KIT*	3" x 3.70"	310701-111-KIT*	7" x 2"

Load Wheels are Ultra-Poly 70D
Steer Wheels are Poly 95A

+Steer wheels are nylon.

*Includes corrosive-resistant surface finish axles and hardware.

**Load Wheel Kits include Load Roller Assemblies w/Bearings, Axles, and Fasteners.

**Complete Wheel Kits include Load Roller Assemblies w/Bearings, Steer Wheel Assemblies w/Bearings, Axles, and Fasteners.

WHEELS AND TIRES

**Electric Pallet Jack
Pre-packaged Wheel Kits**



Brand	Model	Load Wheel Kit Part Number**	Load Wheels OD x W
Baker	EW60	310700-241-KIT*	3.25" x 6.37"
	EW80	310700-241-KIT*	3.25" x 6.37"
	EWR	310700-241-KIT*	3.25" x 6.37"
	EWR60	310700-241-KIT*	3.25" x 6.37"
	EWR80	310700-241-KIT*	3.25" x 6.37"
Barrett	RPX60B	310700-242-KIT*	3.25" x 6"
	RPX80B	310700-242-KIT*	3.25" x 6"
Big Joe	E30	310700-208-KIT*	3" x 3.50"
	WPT45	310700-210-KIT*	3.25" x 4.50"
Blue Giant	EPJ30	310700-208-KIT*	3" x 3.50"
	EPJ40	310700-208-KIT*	3" x 3.50"
	EPJ45	310700-204-KIT*	3.25" x 4.50"
	EPJ60R	310700-240-KIT*	3.25" x 6.50"
BT Prime Mover	PMX 1 Walkie Pallet Truck	310700-209-KIT*	3.25" x 5"
	PMX 45	310700-209-KIT*	3.25" x 5"
	PMX Walkie Pallet Truck	310700-209-KIT*	3.25" x 5"
	SMX 45 Walkie Pallet Truck	310700-204-KIT*	3.25" x 4.50"
CAT	NPP 40	310700-209-KIT*	3.25" x 5"
	NPP 60	310700-221-KIT*	3.25" x 5.93"
	WR 6000	310700-243-KIT*	3.25" x 6.50"
Clark	WPT45	310700-210-KIT*	3.25" x 4.50"
	WPX45	310700-210-KIT*	3.25" x 4.50"
Hyster	B 60Z	310700-215-KIT*	3.25" x 6.50"
	B 80Z	310700-215-KIT*	3.25" x 6.50"
	B60ZHD	310700-215-KIT*	3.25" x 6.50"
	B80ZHD	310700-215-KIT*	3.25" x 6.50"
	W 40 XL/W 40 XT	310700-202-KIT*	3.25" x 4.50"
	W 40Z / 45Z (B218)	310700-203-KIT*	3.25" x 4.50"
	W 60Z	310700-215-KIT*	3.25" x 6.50"
	W 65Z	310700-215-KIT*	3.25" x 6.50"
	W 80Z	310700-215-KIT*	3.25" x 6.50"
	W45XT	310700-216-KIT*	3.25" x 4.50"
W45ZHD	310700-231-KIT*	3.34" x 4.33"	
Jungheinrich	EJE120	310700-218-KIT*	3.25" x 4.50"
Mitsubishi	PW23	310700-218-KIT*	3.25" x 4.50"
Multiton	ELE 35	310700-239-KIT	3.25" x 4"
	ELE 45	310700-239-KIT	3.25" x 4"
Prime Mover	HMX65	310700-246-KIT*	3.25" x 6"
Nissan	RPX60N	310700-242-KIT*	3.25" x 6"
	RPX80N	310700-242-KIT*	3.25" x 6"
	RPXT2	310700-242-KIT*	3.25" x 6"

Load Wheel kits are Durarun Poly 95A

*Includes corrosive-resistant surface finish axles and hardware.

**LW Kits include Load Wheels w/Bearings, Axles, Lube Fittings, and Screws or Roll Pins.



Electric Pallet Jack Pre-packaged Wheel Kits (Continued)

Brand	Model	Load Wheel Kit Part Number**	Load Wheels OD x W
Raymond	102TF	310700-204-KIT*	3.25" x 4.50"
	102XM Walkie Pallet Truck	310700-204-KIT*	3.25" x 4.50"
	112	310700-221-KIT*	3.25" x 5.93"
	6210	310700-247-KIT*^	4" x 3"
	6210 (Walmart)	310700-245-KIT*	4" x 2"
	8210	310700-223-KIT*	3.25" x 4.50"
	8300	310700-221-KIT*	3.25" x 5.93"
	8310	310700-221-KIT*	3.25" x 5.93"
	8400	310700-221-KIT*	3.25" x 5.93"
	8410	310700-221-KIT*	3.25" x 5.93"
	8500	310700-221-KIT*	3.25" x 5.93"
	8510	310700-221-KIT*	3.25" x 5.93"
	8900	310700-221-KIT*	3.25" x 5.93"
		RAS20/25	310700-247-KIT*^
Toyota	6HBE30	310700-221-KIT*	3.25" x 5.93"
	6HBW20	310700-224-KIT*	3.25" x 5"
	6HBW23	310700-204-KIT*	3.25" x 4.50"
	6HBW30	310700-221-KIT*	3.25" x 5.93"
	7HBC30	310700-221-KIT*	3.25" x 5.93"
	7HBE30	310700-221-KIT*	3.25" x 5.93"
	7HBW23	310700-204-KIT*	3.25" x 4.50"
	7HBW30	310700-221-KIT*	3.25" x 5.93"
	8HBE30	310700-221-KIT*	3.25" x 5.93"
	8HBW23	310700-223-KIT*	3.25" x 4.50"
	8HBW30	310700-221-KIT*	3.25" x 5.93"
	Tora-Max TWB40	310700-248-KIT*	3" x 4.50"
Unicarriers	2W7	310700-238-KIT*	3.25" x 4.50"
	WLX	310700-238-KIT*	3.25" x 4.50"
Yale	MP/MPB 040 AC	310700-206-KIT*	3.25" x 4.50"
	MPB 030 AB	310700-206-KIT*	3.25" x 4.50"
	MPB 040 AB	310700-206-KIT*	3.25" x 4.50"
	MPB 040 E (B827)	310700-207-KIT*	3.25" x 4.50"
	MPB 045 VG	310700-231-KIT*	3.34" x 4.33"
	MPE 060E (A896 Series)	310700-215-KIT*	3.25" x 6.50"
	MPE 080E (A890 Series)	310700-215-KIT*	3.25" x 6.50"
	MPE060VG	310700-215-KIT*	3.25" x 6.50"
	MPE080VG	310700-215-KIT*	3.25" x 6.50"
	MPW 045 E (B802)	310700-207-KIT*	3.25" x 4.50"
	MPW 050 E (C802)	310700-207-KIT*	3.25" x 4.50"
	MPW 060E (A897)	310700-215-KIT*	3.25" x 6.50"
	MPW 065E (A894)	310700-215-KIT*	3.25" x 6.50"

Load Wheel kits are Durarun Poly 95A

*Includes corrosive-resistant surface finish axles and hardware.

**LW Kits include Load Wheels w/Bearings, Axles, Lube Fittings, and Screws or Roll Pins.

^Wheel Kit contains four (4) load wheels.

Ball Bearings

*Note: ♦ clearance greater than standard,
 ▲ shoulder bearing ★ high temp
 • alternative durability ■ lip seals



O.D.	I.D.	Width	Manuf. No.	No Seal/Shield	1 Seal	2 Seals	1 Shield	2 Shields	1 Seal, 1 Shield
0.500	0.250	0.219	FRW188			065120-001			
0.625	0.250	0.191	R4			065081-050			
0.875	0.375	0.240	400-6	065081-040					
1.102	0.472	0.310	6001	065081-074▲					
1.125	0.500	0.307	R8			065081-001▲			
1.181	0.393	0.349	6200	065081-012▲ 065081-075▲		065081-069▲		065081-013▲	
1.255	0.472	0.389	6201			065081-011■▲ 065081-015▲		065081-014▲	
1.375	0.500	0.433	1621	065081-039▲	370137♦	065081-037▲			
1.375	0.625	0.339	R10			065081-061▲			
1.375	0.625	0.433	99502H			065081-038▲			
1.378	0.590	0.428	6202	065081-060▲ 065081-073▲		065081-044▲ 311000-022			
1.574	0.669	0.467	6203	065081-082		311000-004 065081-017★■▲		065081-016▲ 809754 065081-036	
1.750	0.750	0.495	1635						
1.844	0.750	0.562	ASF-169-3A			074722			
1.850	0.669	0.546	6303	065081-072▲				065081-002▲	
1.850	0.787	0.546	6204	065081-080		065081-018▲ 065081-066 311000-005 065081-063▲	065081-020▲ 365081-020•	065081-019▲ 805494	
1.850	0.984	0.467	6005						
2.047	0.787	0.586	6304	065081-003▲	065081-004▲ 065081-065▲ 370300 ▲			311000-012	
2.047	0.984	0.586	6205	065081-071▲ 365081-071• 065081-083 042022▲		065081-051♦▲ 311000-006 065081-023▲	065081-021 065081-070▲	065081-022▲ 365081-022•	
2.047	0.984	0.625	87505						311000-011
2.047	0.984	0.709	8505						311000-023
2.047	0.984	0.813	5205						
2.165	1.181	0.507	6006	065081-032▲		370093	311000-001	311000-016	
2.165	1.181	0.901	30BG05S5G	065089-004		055002-027 311000-003 065081-031■ 365081-031•	065081-062▲ 365081-062•		
2.440	0.984	0.669	6305		370185	065081-005▲ 065081-056♦▲ 311000-007	065081-057 365081-057• 365081-057-01▲	311000-013	
2.440	0.984	0.995	5305			065089-003			
2.440	1.181	0.625	6206	065081-024▲		055002-017 065081-010■▲ 365081-010• 065081-054♦▲ 065081-033▲ 065081-052♦▲ 055002-014	065081-025▲ 365081-025•	065081-041▲ 370277•	
2.440	1.378	0.546	6007						
2.441	0.984	0.827	8605						370182▲
2.441	1.181	0.630	BL-206	042023▲					
2.441	1.181	0.938	5206	065025-001▲		065025-002▲			
2.834	1.378	0.669	6207			065081-027▲	311000-019		
2.834	1.181	0.743	6306		055002-018	065081-006▲ 365081-006•▲ 065081-058♦ 065089-005	065081-067▲ 365081-067•	311000-014	
2.834	1.378	1.053	5207			065081-079♦			
2.952	1.771	0.625	6009						
3.149	1.378	0.822	6307	065081-081 065081-009▲		065081-085♦▲ 065081-007	065081-008 365081-008• 365081-008-01▲ 365081-008-02▲	311000-009	
3.149	1.968	0.625	6010	065081-078					
3.149	2.165	0.506	6911			065081-076			
3.185	1.167	0.998	MG206-FFA			380103-358			
3.224	1.375	1.219	MG207-FFWA				380103-426		
3.240	1.380	1.220	MG307			380050-020			
3.250	1.246	1.222	MRS-6					380103-484	

▲WARNING: Cancer and reproductive harm - www.P65Warnings.ca.gov

Ball Bearings (continued)

O.D.	I.D.	Width	Manuf. No.	No Seal/Shield	1 Seal	2 Seals	1 Shield	2 Shields	1 Seal, 1 Shield
3.346	1.771	0.743	6209	065081-029▲		065081-045▲	065081-028, 365081-028●		
3.543	1.574	0.901	6308			065081-042▲			
3.543	1.574	0.901	MRC 308	065081-048					
3.543	1.968	0.783	6210			065081-059			
3.630	1.360	1.220	MG207FFUE			380050-067			
3.740	1.574	1.125	MG208-FFH			380050-063			
3.740	2.362	0.704	6012			065081-034▲			
3.940	2.150	0.830	MG207FFU			380050-078			
3.940	2.560	0.430	16013	807701					
3.940	2.560	0.710	6013			055002-019			
3.970	1.575	1.000	MG208-FFA			370236			
3.975	1.772	1.125	MG209			380050-035			
3.984	1.565	1.119	MG308-FFX			380103-406			
3.990	1.574	1.125	MG208-FFK			380050-017			
4.082	1.575	1.760	MG5208			380050-016			
4.200	1.570	1.040	MG208-FF8			380050-069			
4.220	1.570	1.030	MG208-FF7			380050-066			
4.244	1.374	0.982	MG307-FFAB			380050-077			
4.319	1.574	1.200	MG308-FFAC			380103-492			
4.330	2.362	0.861	6212	065081-030		065081-055▲			
4.387	1.244	1.183	CU2639B					380103-428	
4.486	1.570	1.250	MG308			380050-019			
4.702	1.571	1.100	MG308-FFW			380103-451			
4.990	2.360	1.220	1276			380050-034			
5.905	3.936	0.937	6020			065081-043▲			

▲WARNING: Cancer and reproductive harm - www.P65Warnings.ca.gov

Ball Bearings with Snap Ring



O.D.	I.D.	Width	Manuf. No.	No Seal/ Shield	2 Rubber Seals
1.850	0.787	0.546	6204		065010-001▲
2.047	0.787	0.585	6304		065010-006▲
2.047	0.984	0.585	6205		065010-005▲
2.440	1.378	0.546	6007		065010-004▲
2.834	1.378	1.053	5207	065010-008	

▲WARNING: Cancer - www.P65Warnings.ca.gov

Thrust Bearings



O.D.	I.D.	Width	Manuf. No.	Crown Part No.
1.516	0.865	0.451	22TAG12	380030-048
2.000	1.110	0.630	28TAG12	380050-059
2.211	1.124	0.628	28TAG16H	380105-692
2.760	1.760	0.550	51110	055018-001
2.938	2.010	0.625	T199	065043
5.000	3.875	0.688	T387	065066
7.000	5.813	0.688	T581	065086

Needle Bearings



O.D.	I.D.	Width	Manuf. No.	Crown Part No.
1.000	0.750	0.875	BA121614	065082
1.140	1.180	0.870	HMK2230	380050-068
1.380	1.100	0.980	HK283525	380050-064
1.500	1.187	0.625	YB-1910	072092
1.540	1.100	1.180		380050-060
2.500	2.120	1.000	BA3416Z-OH	065013-004

Thrust Roller Bearing



O.D.	I.D.	Width	Manuf. No.	Crown Part No.
2.240	0.500	1.060	MG205	380050-018

Roller Bearings



O.D.	I.D.	Width	Manuf. No.	Crown Part No.
2.063	1.500	1.250	BR-243320	073449
2.250	1.688	1.000	BR273616	073442
2.830	1.730	0.120	NU207E	065193

Spherical Bearings



O.D.	I.D.	Width	Manuf. No.	Crown Part No.
1.180	0.670	0.550	GE17ES-2RS	380050-062
1.380	0.790	0.630	GE20ES-2RS	380050-025
1.438	0.875	0.765	GEZ22ES-2RS	380050-058
2.438	1.500	1.125	GEZ108ES	370297
4.726	2.555	1.220		380100-515

Bearings

Cone Bearings



O.D.	I.D.	Width	Manuf. No.	Crown Part No.	Use With Cup
	0.580	1.250	L44600LB	312000-007	
	0.747	0.727	LM11900LA	312000-005	
	0.750	0.439	A6075	065045▲	065044▲
	0.750	0.655	LM11949	065137	065136
	0.750	0.755	09067 20024	312000-006	
	0.780	1.630	LM501349	065148	065147
	0.875	0.561	07087	071544	071545
	0.980	0.870	X33205	134610	134609
	1.000	0.813	15100	312000-011	312000-003
	1.000	1.000	L44643	312000-008	065134
	1.063	0.580	L44649	065135 or 380050-075	065134
	1.188	0.847	M86610	065110	065109
	1.250	0.655	LM67048	065106	065105
	1.250	0.715	15123	312000-015	312000-003
	1.250	1.000	2580	135282	135281
	1.375	0.720	LM48548	065131	065118
	1.375	1.052	14136A	312000-013	312000-014
	1.380	0.988	25877	312000-012	312000-004
	1.406	1.003	HM88648	065052	065051
	1.438	1.138	HM89249	065097	065096
	1.625	1.003	26882	065099	065098
	1.781	0.781	LM603049	065133	065132
	1.797	1.003	25590	042020	042019
	1.969	0.847	JLM104948	380050-006	
	2.000	0.880	LM104949	065108	065107
	2.125	1.455	539	065128	065127
	2.165	0.906	JLM506849	065019	065018
	2.165	1.142	JM207049	065024	065023
	2.625	1.196	39590	065101	065100
4.302	2.678	1.030	395LA	380101-226	
	2.688	0.875	399A	380050-072	
	2.880	1.190	33287	065146	065145
	2.950	0.980	JLM714149 N-000	045319*▲	045318▲
	2.952	0.984	JLM714149	077015	077014
	3.150	1.140	X32016X	135495	135500
	3.250	1.313	47686	065161	065162
	3.346	1.142	JM716648	065157	065158
	3.750	1.141	42375	065126	065125

▲WARNING: Cancer and reproductive harm - www.P65Warnings.ca.gov

Cup Bearings



O.D.	I.D.	Width	Manuf. No.	Crown Part No.	Use With Cone
1.576		0.375	A6157	065044▲	065045▲
1.781		0.610	LM11910	065136	065137
1.938		0.562	09195	312000-001	
1.969		0.531	07196	071545	071544 or 071543
1.979		0.560	L44610	065134	065135
2.050		0.710	Y33205	134609	134610
2.328		0.625	LM67010	065105	065106
2.441		0.715	15245	312000-003	312000-015
2.532		0.658	M86649	065109	065110
2.563		0.550	LM48510	065118	065131
2.717		0.625	14274	312000-014	312000-013
2.750		0.750	2523	135281	135282
2.844		0.771	HM88610	065051	065052
2.875		0.748	25821	312000-004	312000-012
2.890		0.580	LM501310	065147	065148
3.063		0.594	LM603011	065132	065133
3.126		0.752	26822	065098	065099
3.126		1.160	HM89210	065096	065097
3.228		0.847	JLM104910	380050-005	
3.250		0.650	LM104911	065107	065108
3.266		0.752	25520	042019	042020
3.543		0.728	JLM506810	065018	065019
3.740		0.925	JM207010	065023	065024
4.250		1.125	532X	065127	065128
4.331		0.074	394A	380050-076	
4.439		0.940	39520	065100	065101
4.528		0.748	JLM714110	077014	077015
4.530		0.750	JLM714110 N-000	045318*▲	045319▲
4.630		0.150	33462	065145	065146
4.920		0.870	Y32016X	135500	135495
5.110		0.945	JH716610	065158	065157
5.250		1.031	47620	065162	065161
5.844		0.844	42584	065125	065126

▲WARNING: Cancer and reproductive harm - www.P65Warnings.ca.gov

Cup & Cone Bearings



O.D.	I.D.	Width	Manuf. No.	Crown Part No.
1.625	0.563		30302	794109-002
1.938	1.063		L446410	794109-001
2.438	1.188	0.688	30206	380050-070
2.438	1.375	0.750	32007X	380050-073
2.440	1.171	0.846	32206	380050-061
2.559	1.181		30206JR	794109-007
2.656	1.500	1.578	LM29748	075717
2.680	1.570	0.750	32008X	311000-024
2.718	1.250	0.781	14124	065069
2.813	1.375	0.938	32207	380100-564
2.835	1.181	0.817	30306	380030-127
2.835	1.375	0.740	30207	380050-056
2.835	1.378	0.709	X30207M	794109-006
2.953	1.772	0.808	32009	380100-530
3.000	1.980	0.969	L44610/L44649	370181
3.125	1.563	0.813	30208	380050-071
3.125	1.938	0.813	32010X	380050-074
3.228	1.969	0.847	JLM104910/JLM104948	380030-244
3.347	0.748	0.974	32209	380050-055
3.350	1.770	0.820	30209	380050-065
3.540	2.170	0.910	32011XJ	794109-004
3.540	2.170	0.910	32011	380050-036
3.543	0.748	0.974	32210	380050-057
3.740	2.360	1.220		380050-054
3.740	2.362	0.906		380030-126
3.938	2.188	1.063	32211	380100-565
3.940	2.560	0.910	32013XU	794109-003
4.331	0.945	0.906	32212	380050-003
4.921	0.827	1.034	30214	380050-004

Tire Application Guide

Tires

Wheel Series	Compound Number ††	Non-Marking Compound*	Shore A Hardness	Application Types				
				Long Runs/ Heavy Loads	Dock Boards/ Expansion Joints (Chunking)	Metal Chips/ Floor Debris (Flat Spotting)	Wet Conditions	Freezer
100 SERIES Light Duty	These economical 100 Series Light Duty wheel compounds are best suited for light loads and intermittent use.							
	141	151	91A		○	○	○	○
	142	152	93A		○	○	○	○
200 SERIES Mid-Range	The Mid-Range wheels are designed for light to medium loads and short to medium runs.							
	241	251	87A		●	●	●	●
	242	252	85A		●	●	●	●
300 SERIES High Capacity	For the typical demands of most applications, High Capacity wheels feature compounds designed for high capacities and long runs.							
	341	351	93A	●	●	●	●	●
	342	352	90A	●	●	●	●	●
	343	353	85A	●	●	●	●	●
	348	358	95A	●	●	●	●	●
400 SERIES Heavy Duty	Heavy Duty wheels are designed for maximum capacities and extreme runs.							
	441	451	99A	●				
	442		93A	●	●	●		
Center Groove				●				
Thick Sipe							●	●
Thin Sipe							●	●
Diamond Groove							●	○
Hole Pattern							●	●

* - All Polyurethane tires are non-marking

†† - Not all compounds are available

○ = Good

● = Better

● = Best

WHEELS AND TIRES

Treads

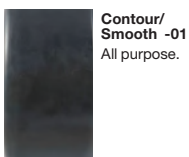

Contour/Smooth -01
All purpose.



Center Groove -02
Dissipates heat and provides better traction. Heavy loads, long runs, extreme heat.

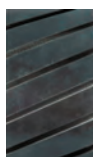

22° Thick Sipe -03
Increase traction. Good for wet/freezer application, standing water.

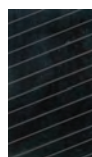

22° Thin Sipe -04
Increase traction. Great for wet/freezer application.

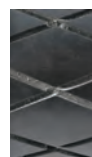

Diamond Groove -05
Increase traction. Good for wet/freezer application, standing water.





Hole Pattern -06
Great on damp floors, produce areas, and cold storage facilities. Resistant to chunking and tearing.

NOTE: Treads not available in all sizes.



Call your local Crown dealer to help you determine the right load wheels or tires for your application and start minimizing costs and maximizing productivity today.

Polyurethane Tires by Size

Tire O.D.	Tire Width	Tire I.D.	Crown Base Part No.	Notes
6.00				
6.00	3.00	4.000	310198	
8.00				
8.00	4.00	6.250	310002	
8.00	4.00	6.500	310199	
8.00	4.50	6.500	310246	1" Insert for Brake
8.00	4.50	4.500	310003	
8.50				
8.50	4.00	4.000	077984	
9.00				
9.00	2.88	6.630	310296	
9.00	3.50	6.500	310005	
9.00	5.00	5.000	077848	
9.00	5.00	5.000	317848	
9.00	5.00	5.750	126266	
9.00	7.00	6.250	310293	
9.84				
9.84	3.94	5.710	140346	
10.00				
10.00	3.00	7.500	310007	
10.00	3.50	8.000	310008	
10.00	4.00	6.500	075715	
10.00	4.00	6.500	310049	
10.00	4.00	7.500	310341	
10.00	4.50	7.000	310237	
10.00	4.50	8.000	310009	
10.00	4.75	6.500	310011	Contour Profile
10.00	4.75	6.500	310200	10° Angle
10.00	5.00	6.500	107933	Contour - 18° Angle
10.00	5.00	6.500	310294	Contour - 18° Angle
10.00	5.00	6.500	310012	Smooth 15° Angle
10.00	5.00	6.500	310202	Beveled Edge
10.00	6.00	6.250	310013	
10.00	6.00	6.500	310014	
10.00	7.00	6.250	310015	
10.00	7.00	8.000	310016	
10.50				
10.50	3.50	8.000	310017	
10.50	4.00	8.000	105088	
10.50	4.50	8.000	105089	
10.50	5.00	5.000	310019	
10.50	5.00	6.500	310020	
10.50	6.00	5.000	310021	
10.50	6.00	6.500	310022	
10.50	6.50	8.000	310023	
10.50	7.00	6.500	310024	
10.50	8.00	6.500	310311	
12.00				
12.00	4.00	8.000	310030	
12.00	4.50	8.000	310025	
12.00	5.00	8.000	310027	
12.00	5.00	9.000	310026	Contour Profile
12.00	5.00	9.000	310029	Smooth
12.00	5.50	8.000	310028	
12.75				
12.75	5.50	8.000	310285	
13.00				
13.00	4.50	8.000	079494	
13.00	4.50	8.000	310031	Angled to a 2" footprint
13.00	4.50	8.000	310204	
13.00	4.50	10.000	310032	
13.00	5.50	8.000	079266	
13.00	5.50	8.000	319266	
13.00	5.50	9.500	121501	
13.00	5.50	9.500	310214	
13.00	6.00	10.500	310034	

Tire O.D.	Tire Width	Tire I.D.	Crown Base Part No.	Notes
13.50	5.00	8.000	310038	
13.50	5.50	8.000	077050	Contour Profile
13.50	5.50	8.000	310039	Smooth
13.50	5.50	10.000	310053	
13.50	5.50	10.500	310284	
13.50	6.00	8.000	100368	
13.50	6.00	10.000	114493	
13.50	6.00	10.000	314493	
13.50	6.00	10.500	310037	
13.50	6.50	8.000	310040	
13.50	7.00	8.000	100700	
13.50	7.00	10.000	114494	
13.50	7.00	10.000	314494	
13.75				
13.75	5.50	10.500	310286	
14.00				
14.00	4.50	8.000	310042	
14.00	5.00	10.000	310045	
14.00	5.00	11.250	310044	
14.00	6.00	11.250	310046	
14.00	8.00	10.250	310271	
14.00	8.00	11.250	310047	
14.75				
14.75	6.50	10.750	310272	
15.00				
15.00	5.00	11.250	310048	
15.00	6.00	11.250	310052	
15.00	6.00	11.750	310054	
15.00	6.50	10.750	310463	
15.00	7.00	11.250	310055	
15.00	8.00	11.200	090270	
15.00	8.00	11.250	310056	
15.25				
15.25	7.00	11.250	133904	
15.50				
15.50	5.00	10.000	310057	
15.50	6.00	10.000	310058	
15.98				
15.98	6.69	13.190	149214	
16.00				
16.00	4.00	12.125	310059	
16.00	5.00	10.500	310060	
16.00	6.00	10.500	310061	
16.00	7.00	10.500	139567	
16.00	7.00	10.500	310567	
16.00	7.00	12.000	310063	
16.25				
16.25	5.00	11.250	310064	
16.25	6.00	11.250	310065	
16.25	7.00	11.250	310066	
16.25	10.00	11.250	310228	
18.00				
18.00	5.00	12.125	310067	
18.00	6.00	12.125	310068	
18.00	7.00	12.125	310069	
18.00	7.00	15.000	310070	
18.00	8.00	12.125	310071	
18.00	9.00	12.125	310072	
20.00				
20.00	9.00	16.000	310503	
21.00				
21.00	7.00	15.000	310073	
21.00	8.00	15.000	310121	
22.00				
22.00	5.00	16.000	310074	
22.00	8.00	16.000	310075	
22.00	9.00	16.000	310207	
22.00	10.00	16.000	310076	

Note: Add the compound and tread part number to the base number listed above. Compounds and treads listed on page 11.19. Complete part number format is XXXXXX-XXX-XX.



Hole Tires

Polyurethane Hole Pattern Tires

- Great on damp floors
- Resistance to chunking and tearing
- Cold storage applications
- Produce areas

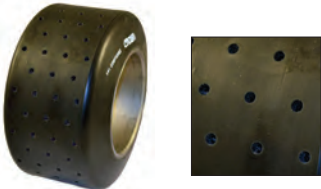

O.D.	Width	I.D.	Crown Part No.
9.00	5.00	5.000	317848-341-06
9.00	5.00	5.750	316266-341-06
10.00	4.00	6.500	310049-243-06
10.00	4.75	6.500	310011-341-06
10.00	5.00	6.500	310294-341-06
10.00	7.00	6.250	310015-341-06
12.00	4.50	8.000	310025-341-06
12.00	5.50	8.000	310028-341-06
12.00	5.50	8.000	310028-351-06
13.00	4.50	8.000	310204-243-06
13.00	4.50	8.000	310204-341-06
13.00	4.50	8.000	310204-352-06
13.00	5.50	8.000	319266-243-06
13.00	5.50	8.000	319266-253-06
13.00	5.50	8.000	319266-341-06
13.00	5.50	9.500	121501-243-06
13.00	5.50	9.500	121501-341-06
13.00	5.50	9.500	121501-342-06

O.D.	Width	I.D.	Crown Part No.
13.00	5.50	9.500	121501-351-06
13.00	5.50	9.500	121501-352-06
13.50	4.50	8.000	310035-243-06
13.50	4.50	8.000	310035-341-06
13.50	5.50	8.000	310039-243-06
13.50	5.50	8.000	310039-341-06
13.50	5.50	8.000	310039-342-06
13.50	6.00	8.000	310368-341-06
13.50	6.00	10.000	314493-341-06
13.50	6.00	10.500	310037-243-06
13.50	6.00	10.500	310037-341-06
13.50	6.00	10.500	310037-342-06
13.50	7.00	10.000	314494-341-06
15.00	5.00	11.250	310048-243-06
15.00	5.00	11.250	310048-341-06
16.00	6.00	10.500	310061-243-06
16.00	7.00	10.500	310567-341-06
16.25	6.00	11.250	310065-341-06
16.25	7.00	11.250	310066-341-06
18.00	7.00	12.130	310069-243-06
18.00	7.00	12.130	310069-341-06

Tire Racks

Tire Racks

Part Number	Description	Outside Dimensions
300134	3 shelves	3'10" W x 3'7" D x 6' H
300134-001	4 shelves	3'4" W x 2'6" D x 5'6.25" H

⚠ WARNING: Cancer and reproductive harm - www.P65Warnings.ca.gov



300134



300134-001

Tools



Shore A Durometer

Part Number - 390223

Measures wheel and tire Shore A hardness.
Test range: 0-100 HA.

Tread Reference Only



**201 & 211
421 & 431**



**301 & 311
305 & 315**



**302 & 312
427 & 429**



307 & 317



402 & 412



404 & 414



408 & 418



Profile/Compound Key		Manufacturer Key	
CG	Center Groove	CO	Continental
DS	Diamond Sipe	CS	Camso/Solideal
RS	Router Sipe	ML	Millennium
SM	Smooth	RR	Roadrunner
FG	Fiberglass	SU	Superior
		TR	Trelleborg/Monarch

Tire O.D.	Tire Width	Tire I.D.	Profile	Compound	Crown Part No.	Manuf.
8.50						
8.50	4.00	4.00	SM	Rubber	350071-302-41	TR ☀️
9.00						
9.00	5.00	5.000	SM	Rubber	076751-001	TR
9.00	5.00	5.000	SM	Rubber NM Cream	076751-003	TR
9.00	5.00	5.000	SM	Rubber	350049-408-41	CS
9.00	5.00	5.000	SM	Rubber NM Grey	350049-316-41	CS
9.84						
9.84	3.35	7.480	RS	Rubber	808185	
10.00						
10.00	3.00	6.250	SM	Rubber	350004-303-41	ML
10.00	4.00	6.500	SM	Rubber	127251-201-41	RR ⚠️
10.00	4.00	6.500	Traction	Rubber	127251-201-42	RR ⚠️
10.00	4.00	6.500	DS	Rubber	127251-301-05	CS
10.00	4.00	6.500	SM	Rubber	127251-301-41	CS
10.00	4.00	6.500	DS	Rubber NM Grey	127251-311-05	CS
10.00	4.00	6.500	SM	Rubber NM Grey	127251-311-41	CS
10.00	4.00	6.500	SM	Rubber	127251-407-41	ML
10.00	4.00	6.500	DS	FG	127251-421-05	RR ⚠️
10.00	4.00	6.500	SM	FG	127251-421-41	RR ⚠️
10.00	4.00	6.500	Traction	FG	127251-421-42	RR ⚠️
10.00	4.00	6.500	SM	Walnut	127251-429-41	ML
10.00	4.00	6.500	DS	Rubber	357251-402-05	TR
10.00	4.00	6.500	SM	Rubber	357251-402-41	TR
10.00	4.00	6.500	SM	Rubber	357251-404-41	CO
10.00	4.00	6.500	SM	Rubber NM Cream	357251-412-41	TR
10.00	4.00	6.500	SM	Rubber NM Cream	357251-414-41	CO
10.00	4.00	6.500	SM	Rubber NM Grey	357251-418-41	CS
10.00	4.00	6.500	SM	FG	357251-421-41	RR
10.00	4.00	6.500	SM	Rubber	357251-450-41	CS
10.00	4.00	6.500	SM	Rubber NM Grey	357251-460-41	CS
10.00	4.75	6.500	SM	Rubber	350005-303-41	ML
10.00	4.75	6.500	Traction	Rubber	350005-303-42	ML
10.00	4.75	6.500	SM	Rubber NM Cream	350005-313-41	ML
10.00	4.75	6.500	SM	Rubber	350005-408-41	CS
10.00	4.75	6.500	SM	FG	350005-428-41	ML
10.00	4.75	6.500	Traction	FG	350005-428-42	ML
10.00	5.00	6.500	SM	Rubber	135907-301-41	CS
10.00	5.00	6.500	CG	Rubber	135907-301-42	CS
10.00	5.00	6.500	SM	Rubber	135907-305-41	CS
10.00	5.00	6.500	CG	Rubber	135907-305-42	CS
10.00	5.00	6.500	SM	Rubber NM Grey	135907-311-41	CS
10.00	5.00	6.500	CG	Rubber NM Grey	135907-311-42	CS
10.00	5.00	6.500	SM	Rubber NM Grey	135907-315-41	CS
10.00	5.00	6.500	CG	Rubber NM Grey	135907-315-42	CS
10.00	5.00	6.500	SM	Rubber	350007-201-41	RR
10.00	5.00	6.500	Traction	Rubber	350007-201-42	RR
10.00	5.00	6.500	SM	Rubber NM Dk Grey	350007-211-41	RR
10.00	5.00	6.500	Traction	Rubber NM Dk Grey	350007-211-42	RR
10.00	5.00	6.500	SM	Rubber	350007-303-41	ML
10.00	5.00	6.500	Traction	Rubber	350007-303-42	ML
10.00	5.00	6.500	SM	Rubber	350007-309-41	SU

Tire O.D.	Tire Width	Tire I.D.	Profile	Compound	Crown Part No.	Manuf.
10.00	5.00	6.500	SM	Rubber NM Cream	350007-313-41	ML
10.00	5.00	6.500	SM	Rubber NM	350007-319-41	SU
10.00	5.00	6.500	DS	Rubber	350007-402-05	TR
10.00	5.00	6.500	SM	Rubber	350007-402-41	TR
10.00	5.00	6.500	SM	Rubber	350007-404-41	CO
10.00	5.00	6.500	Traction	Rubber	350007-408-42	CS
10.00	5.00	6.500	SM	Rubber NM Cream	350007-412-41	TR
10.00	5.00	6.500	SM	Rubber NM Cream	350007-414-41	CO
10.00	5.00	6.500	SM	Rubber NM Grey	350007-418-41	CS
10.00	5.00	6.500	Traction	Rubber NM Grey	350007-418-42	CS
10.00	5.00	6.500	Thin Sipe	FG	350007-421-04	RR
10.00	5.00	6.500	SM	FG	350007-421-41	RR
10.00	5.00	6.500	Traction	FG	350007-421-42	RR
10.00	5.00	6.500	SM	Wire	350007-423-41	ML
10.00	5.00	6.500	SM	FG Severe Duty	350007-424-41	ML
10.00	5.00	6.500	SM	Walnut	350007-429-41	ML
10.00	5.00	6.500	SM	Walnut NM White	350007-439-41	ML
10.00	5.00	6.500	SM	Rubber	350007-450-41	CS
10.00	5.00	6.500	SM	Rubber NM Grey	350007-460-41	CS
10.00	5.00	6.500	SM	Rubber	350202-201-41	RR
10.00	5.00	6.500	Traction	Rubber	350202-201-42	RR
10.00	5.00	6.500	Traction	Rubber NM Cream	350202-313-42	ML
10.00	5.00	6.500	SM	Rubber	350202-408-41	CS
10.00	5.00	6.500	Traction	Rubber	350202-408-42	CS
10.00	5.00	6.500	SM	FG	350202-421-41	RR
10.00	5.00	6.500	Traction	FG	350202-421-42	RR
10.00	6.00	6.250	SM	Rubber NM Cream	350008-313-41	ML
10.00	6.00	6.500	Traction	Rubber	350020-303-42	ML
10.00	6.00	6.500	Traction	FG	350038-428-42	ML
10.50						
10.50	5.00	6.500	SM	Rubber	350009-302-41	TR
10.50	5.00	6.500	Traction	Rubber	350009-302-42	TR
10.50	5.00	6.500	SM	Rubber NM Cream	350009-312-41	TR
10.50	5.00	6.500	SM	FG	350009-421-41	RR
12.00						
12.00	4.50	8.000	SM	Rubber	350032-402-41	TR
12.00	4.50	8.000	Traction	Rubber	350032-402-42	TR
12.00	4.50	8.000	SM	Rubber	350032-408-41	CS
12.00	4.50	8.000	SM	Rubber NM Cream	350032-412-41	TR
12.00	4.50	8.000	SM	FG	350032-421-41	RR
12.00	5.00	8.000	SM	Walnut	350053-429-41	ML
12.00	5.50	8.000	SM	Rubber	350010-302-41	TR
12.00	5.50	8.000	Traction	FG	350010-421-42	RR
12.00	5.50	8.000	SM	Walnut	350010-429-41	ML
13.50						
13.50	4.50	8.000	SM	Rubber	350011-303-41	ML
13.50	4.50	8.000	SM	FG	350034-421-41	RR
13.50	4.50	8.000	Traction	FG	350034-421-42	RR
13.50	4.50	8.000	SM	FG	350034-422-41	SU
13.50	4.50	8.000	SM	FG NM White	350034-438-41	ML
13.50	5.50	8.000	SM	FG	074458-004	RR ⚠️
13.50	5.50	8.000	Traction	FG	074458-005	RR
13.50	5.50	8.000	Traction	FG	074458-011	ML
13.50	5.50	8.000	SM	Rubber	074458-301-41	CS
13.50	5.50	8.000	Traction	Rubber	074458-301-42	CS
13.50	5.50	8.000	Traction	Rubber	074458-402-42	TR
13.50	5.50	8.000	Traction	Rubber NM Cream	074458-412-42	TR
13.50	5.50	8.000	SM	Rubber	350031-201-41	RR
13.50	5.50	8.000	Traction	Rubber	350031-201-42	RR
13.50	5.50	8.000	Traction	Rubber NM Dk Grey	350031-211-42	RR
13.50	5.50	8.000	SM	Rubber	350031-303-41	ML

Rubber Tires by Size

Continued ▶

Note: Profile and manufacturer key on page 11.22.

13.50 O.D. Continued

Tire O.D.	Tire Width	Tire I.D.	Profile	Compound	Crown Part No.	Manuf.
13.50	5.50	8.000	Traction	Rubber	350031-303-42	ML
13.50	5.50	8.000	SM	Rubber	350031-309-41	SU
13.50	5.50	8.000	SM	Rubber NM Cream	350031-313-41	ML
13.50	5.50	8.000	SM	Rubber	350031-402-41	TR
13.50	5.50	8.000	SM	Rubber	350031-404-41	CO
13.50	5.50	8.000	SM	Rubber	350031-408-41	CS
13.50	5.50	8.000	Traction	Rubber	350031-408-42	CS
13.50	5.50	8.000	SM	Rubber NM Cream	350031-412-41	TR
13.50	5.50	8.000	SM	Rubber NM Cream	350031-414-41	CO
13.50	5.50	8.000	SM	Rubber NM Grey	350031-418-41	CS
13.50	5.50	8.000	Traction	Rubber NM Grey	350031-418-42	CS
13.50	5.50	8.000	Thin Sipe	FG	350031-421-04	RR
13.50	5.50	8.000	Traction	FG	350031-421-42	RR
13.50	5.50	8.000	SM	FG Severe Duty	350031-424-41	ML
13.50	5.50	8.000	SM	Walnut	350031-427-41	ML
13.50	5.50	8.000	Traction	Walnut	350031-427-42	ML
13.50	5.50	8.000	SM	FG	350031-428-41	ML
13.50	5.50	8.000	SM	FG NM Black	350031-431-41	RR
13.50	5.50	8.000	Traction	FG NM Black	350031-431-42	RR
13.50	5.50	8.000	Traction	Walnut NM White	350031-437-42	ML
13.50	5.50	8.000	SM	Rubber	350031-450-41	CS
13.50	5.50	8.000	SM	Rubber NM Grey	350031-460-41	CS
13.50	6.50	8.000	SM	Rubber	108410-305-41	CS
13.50	6.50	8.000	SM	FG	350203-421-41	RR
13.50	6.50	8.000	Traction	FG	350203-421-42	RR
14.00						
14.00	4.50	8.000	SM	Rubber	350012-201-41	RR
14.00	4.50	8.000	Traction	Rubber	350012-201-42	RR
14.00	4.50	8.000	SM	Rubber NM Dk Grey	350012-211-41	RR
14.00	4.50	8.000	Traction	Rubber NM Dk Grey	350012-211-42	RR
14.00	4.50	8.000	Traction	Rubber	350012-302-42	TR
14.00	4.50	8.000	SM	Rubber	350012-402-41	TR
14.00	4.50	8.000	SM	Rubber	350012-408-41	CS
14.00	4.50	8.000	Traction	Rubber	350012-408-42	CS
14.00	4.50	8.000	SM	Rubber NM Cream	350012-412-41	TR
14.00	4.50	8.000	SM	Rubber NM Cream	350012-414-41	CO
14.00	4.50	8.000	SM	Rubber NM Grey	350012-418-41	CS
14.00	4.50	8.000	Traction	Rubber NM Grey	350012-418-42	CS
14.00	4.50	8.000	SM	FG	350012-421-41	RR
14.00	4.50	8.000	Traction	FG	350012-421-42	RR
14.00	4.50	8.000	SM	FG NM Black	350012-431-41	RR
14.00	4.50	8.000	Traction	FG NM Black	350012-431-42	RR
14.00	5.00	10.000	SM	Rubber	350045-408-41	CS
14.00	5.00	10.000	Traction	Rubber	350045-408-42	CS
14.00	5.00	10.000	SM	Rubber NM Cream	350045-412-41	TR
14.00	5.00	10.000	Traction	Rubber NM Cream	350045-412-42	TR
14.00	5.00	10.000	SM	Rubber NM Grey	350045-418-41	CS
14.00	5.00	10.000	Traction	Rubber NM Grey	350045-418-42	CS
15.00						
15.00	4.00	11.250	SM	Rubber NM Cream	350044-312-41	TR
15.00	4.00	11.250	SM	Rubber	350044-408-41	CS
15.00	5.00	11.250	SM	Rubber	137031-301-41	CS
15.00	5.00	11.250	Traction	Rubber	137031-301-42	CS
15.00	5.00	11.250	SM	Rubber NM Grey	137031-311-41	CS
15.00	5.00	11.250	Traction	Rubber NM Grey	137031-311-42	CS
15.00	5.00	11.250	SM	Rubber	350033-201-41	RR
15.00	5.00	11.250	Traction	Rubber	350033-201-42	RR
15.00	5.00	11.250	SM	Rubber NM Dk Grey	350033-211-41	RR
15.00	5.00	11.250	Traction	Rubber NM Dk Grey	350033-211-42	RR
15.00	5.00	11.250	SM	Rubber	350033-303-41	ML
15.00	5.00	11.250	Traction	Rubber	350033-303-42	ML
15.00	5.00	11.250	SM	Rubber NM Cream	350033-313-41	ML
15.00	5.00	11.250	SM	Rubber	350033-402-41	TR
15.00	5.00	11.250	Traction	Rubber	350033-402-42	TR
15.00	5.00	11.250	SM	Rubber	350033-404-41	CO
15.00	5.00	11.250	Traction	Rubber	350033-404-42	CO
15.00	5.00	11.250	SM	Rubber NM Cream	350033-408-41	CS
15.00	5.00	11.250	Traction	Rubber	350033-408-42	CS

Tire O.D.	Tire Width	Tire I.D.	Profile	Compound	Crown Part No.	Manuf.
15.00	5.00	11.250	SM	Rubber NM Cream	350033-412-41	TR
15.00	5.00	11.250	Traction	Rubber NM Cream	350033-412-42	TR
15.00	5.00	11.250	SM	Rubber NM Cream	350033-414-41	CO
15.00	5.00	11.250	SM	Rubber NM Grey	350033-418-41	CS
15.00	5.00	11.250	Traction	Rubber NM Grey	350033-418-42	CS
15.00	5.00	11.250	SM	FG	350033-421-41	RR
15.00	5.00	11.250	Traction	FG	350033-421-42	RR
15.00	5.00	11.250	SM	Walnut	350033-429-41	ML
15.00	5.00	11.250	Traction	Walnut	350033-429-42	ML
15.00	5.00	11.250	SM	Rubber	350033-450-41	CS
15.00	5.00	11.250	SM	Rubber NM Grey	350033-460-41	CS
15.00	6.00	11.250	SM	Rubber	350052-201-41	RR
15.00	6.00	11.250	Traction	Rubber	350052-201-42	RR
15.00	7.00	11.250	SM	Rubber	350028-201-41	RR
16.00						
16.00	5.00	10.500	SM	Rubber	350016-201-41	RR
16.00	5.00	10.500	Traction	Rubber	350016-201-42	RR
16.00	5.00	10.500	SM	Rubber NM Dk Grey	350016-211-41	RR
16.00	5.00	10.500	Traction	Rubber NM Dk Grey	350016-211-42	RR
16.00	5.00	10.500	SM	Rubber	350016-402-41	TR
16.00	5.00	10.500	Traction	Rubber	350016-402-42	TR
16.00	5.00	10.500	SM	Rubber	350016-404-41	CO
16.00	5.00	10.500	Traction	Rubber	350016-404-42	CO
16.00	5.00	10.500	SM	Rubber	350016-408-41	CS
16.00	5.00	10.500	Traction	Rubber	350016-408-42	CS
16.00	5.00	10.500	SM	Rubber NM Cream	350016-412-41	TR
16.00	5.00	10.500	SM	Rubber NM Cream	350016-414-41	CO
16.00	5.00	10.500	Traction	Rubber NM Cream	350016-414-42	CO
16.00	5.00	10.500	SM	Rubber NM Grey	350016-418-41	CS
16.00	5.00	10.500	Traction	Rubber NM Grey	350016-418-42	CS
16.00	5.00	10.500	SM	FG	350016-421-41	RR
16.00	5.00	10.500	Traction	FG	350016-421-42	RR
16.00	5.00	10.500	SM	FG NM Black	350016-431-41	RR
16.00	5.00	10.500	Traction	FG NM Black	350016-431-42	RR
16.00	5.00	10.500	SM	Rubber	350016-450-41	CS
16.00	5.00	10.500	SM	Rubber NM Grey	350016-460-41	CS
16.00	6.00	10.500	SM	Rubber	136162-301-41	CS
16.00	6.00	10.500	Traction	Rubber	136162-301-42	CS
16.00	6.00	10.500	SM	Rubber	136162-305-41	CS
16.00	6.00	10.500	Traction	Rubber	136162-305-42	CS
16.00	6.00	10.500	SM	Rubber NM Grey	136162-311-41	CS
16.00	6.00	10.500	Traction	Rubber NM Grey	136162-311-42	CS
16.00	6.00	10.500	SM	Rubber NM Grey	136162-315-41	CS
16.00	6.00	10.500	Traction	Rubber NM Grey	136162-315-42	CS
16.00	6.00	10.500	SM	Rubber	350054-201-41	RR
16.00	6.00	10.500	Traction	Rubber	350054-201-42	RR
16.00	6.00	10.500	SM	Rubber NM Dk Grey	350054-211-41	RR
16.00	6.00	10.500	Traction	Rubber NM Dk Grey	350054-211-42	RR
16.00	6.00	10.500	SM	Rubber	350054-303-41	ML
16.00	6.00	10.500	Traction	Rubber	350054-303-42	ML
16.00	6.00	10.500	SM	Rubber NM Cream	350054-313-41	ML
16.00	6.00	10.500	SM	Rubber	350054-402-41	TR
16.00	6.00	10.500	Traction	Rubber	350054-402-42	TR
16.00	6.00	10.500	SM	Rubber	350054-404-41	CO
16.00	6.00	10.500	Traction	Rubber	350054-404-42	CO
16.00	6.00	10.500	SM	Rubber	350054-408-41	CS
16.00	6.00	10.500	Traction	Rubber	350054-408-42	CS
16.00	6.00	10.500	SM	Rubber NM Cream	350054-412-41	TR
16.00	6.00	10.500	Traction	Rubber NM Cream	350054-412-42	TR
16.00	6.00	10.500	SM	Rubber NM Cream	350054-414-41	CO
16.00	6.00	10.500	Traction	Rubber NM Cream	350054-414-42	CO
16.00	6.00	10.500	SM	Rubber NM Grey	350054-418-41	CS
16.00	6.00	10.500	Traction	Rubber NM Grey	350054-418-42	CS
16.00	6.00	10.500	SM	FG	350054-421-41	RR
16.00	6.00	10.500	Traction	FG	350054-421-42	RR
16.00	6.00	10.500	SM	FG NM Black	350054-431-41	RR
16.00	6.00	10.500	Traction	FG NM Black	350054-431-42	RR
16.00	6.00	10.500	SM	Rubber	350054-450-41	CS

WHEELS AND TIRES

Rubber Tires by Size

Continued ▶

Note: Profile and manufacturer key on page 11.22.

16.00 O.D. Continued

Tire O.D.	Tire Width	Tire I.D.	Profile	Compound	Crown Part No.	Manuf.
16.00	6.00	10.500	SM	Rubber NM Grey	350054-460-41	CS
16.00	7.00	10.500	SM	Rubber	135906-301-41	CS
16.00	7.00	10.500	Traction	Rubber	135906-301-42	CS
16.00	7.00	10.500	SM	Rubber	135906-305-41	CS
16.00	7.00	10.500	Traction	Rubber	135906-305-42	CS
16.00	7.00	10.500	SM	Rubber NM Grey	135906-311-41	CS
16.00	7.00	10.500	Traction	Rubber NM Grey	135906-311-42	CS
16.00	7.00	10.500	SM	Rubber NM Grey	135906-315-41	CS
16.00	7.00	10.500	Traction	Rubber NM Grey	135906-315-42	CS
16.00	7.00	10.500	SM	Rubber	350051-303-41	ML
16.00	7.00	10.500	Traction	Rubber	350051-303-42	ML
16.00	7.00	10.500	SM	Rubber NM Cream	350051-313-41	ML
16.00	7.00	10.500	SM	Rubber	350051-402-41	TR
16.00	7.00	10.500	SM	Rubber	350051-404-41	CO
16.00	7.00	10.500	Traction	Rubber	350051-408-42	CS
16.00	7.00	10.500	SM	Rubber NM Cream	350051-412-41	TR
16.00	7.00	10.500	SM	Rubber NM Cream	350051-414-41	CO
16.00	7.00	10.500	SM	Rubber NM Grey	350051-418-41	CO
16.00	7.00	10.500	Traction	Rubber NM Grey	350051-418-42	CO
16.00	7.00	10.500	SM	FG	350051-421-41	RR
16.00	7.00	10.500	Traction	FG	350051-421-42	RR
16.00	7.00	10.500	SM	Walnut	350051-429-41	ML
16.00	7.00	10.500	Traction	Walnut	350051-429-42	ML
16.00	7.00	10.500	SM	Walnut NM White	350051-439-41	ML
16.00	7.00	10.500	SM	Rubber	350051-450-41	CS
16.00	7.00	10.500	SM	Rubber NM Grey	350051-460-41	CS
16.25						
16.25	5.00	11.250	Traction	Rubber	350017-302-42	TR
16.25	5.00	11.250	Traction	Rubber NM Cream	350017-312-42	TR
16.25	5.00	11.250	SM	Rubber	350017-402-41	TR
16.25	5.00	11.250	SM	Rubber	350017-408-41	CS
16.25	5.00	11.250	Traction	Rubber	350017-408-42	CS
16.25	5.00	11.250	SM	Rubber NM Cream	350017-412-41	TR
16.25	5.00	11.250	SM	Rubber NM Grey	350017-418-41	CS
16.25	5.00	11.250	Traction	Rubber NM Grey	350017-418-42	CS
16.25	5.00	11.250	SM	FG	350017-421-41	RR
16.25	5.00	11.250	Traction	FG	350017-421-42	RR
16.25	6.00	11.250	SM	Rubber	350018-201-41	RR
16.25	6.00	11.250	Traction	Rubber	350018-201-42	RR
16.25	6.00	11.250	SM	Rubber NM Dk Grey	350018-211-41	RR
16.25	6.00	11.250	Traction	Rubber NM Dk Grey	350018-211-42	RR
16.25	6.00	11.250	SM	Rubber	350018-402-41	TR
16.25	6.00	11.250	Traction	Rubber	350018-402-42	TR
16.25	6.00	11.250	SM	Rubber	350018-404-41	CO
16.25	6.00	11.250	SM	Rubber	350018-408-41	CS
16.25	6.00	11.250	Traction	Rubber	350018-408-42	CS
16.25	6.00	11.250	SM	Rubber NM Cream	350018-412-41	TR
16.25	6.00	11.250	SM	Rubber NM Cream	350018-414-41	CO
16.25	6.00	11.250	SM	Rubber NM Grey	350018-418-41	CS
16.25	6.00	11.250	Traction	Rubber NM Grey	350018-418-42	CS
16.25	6.00	11.250	SM	FG	350018-421-41	RR
16.25	6.00	11.250	Traction	FG	350018-421-42	RR
16.25	6.00	11.250	SM	Rubber NM Grey	350018-460-41	CS
16.25	7.00	11.250	Traction	Rubber	350002-302-42	TR
16.25	7.00	11.250	Traction	Rubber NM Cream	350002-312-42	TR
16.25	7.00	11.250	SM	Rubber	350002-402-41	TR
16.25	7.00	11.250	SM	Rubber	350002-408-41	CS
16.25	7.00	11.250	SM	Rubber NM Cream	350002-412-41	TR
16.25	7.00	11.250	SM	Rubber NM Grey	350002-418-41	CS
17.00						
17.00	5.00	12.125	SM	Rubber	350019-302-41	TR 
17.00	5.00	12.125	SM	Rubber	350019-408-41	CS
18.00						
18.00	5.00	12.125	SM	Rubber	350021-302-41	TR
18.00	5.00	12.125	Traction	Rubber	350021-302-42	TR
18.00	5.00	12.125	SM	Rubber NM Cream	350021-312-41	TR
18.00	6.00	12.125	SM	Rubber	141058-301-41	CS
18.00	6.00	12.125	Traction	Rubber	141058-301-42	CS

 New part

18.00 O.D. Continued ▶

Tire O.D.	Tire Width	Tire I.D.	Profile	Compound	Crown Part No.	Manuf.
18.00	6.00	12.125	SM	Rubber NM Grey	141058-311-41	CS
18.00	6.00	12.125	Traction	Rubber NM Grey	141058-311-42	CS
18.00	6.00	12.125	SM	Rubber	350022-201-41	RR
18.00	6.00	12.125	Traction	Rubber	350022-201-42	RR
18.00	6.00	12.125	SM	Rubber NM Dk Grey	350022-211-41	RR
18.00	6.00	12.125	Traction	Rubber NM Dk Grey	350022-211-42	RR
18.00	6.00	12.125	SM	Rubber	350022-402-41	TR
18.00	6.00	12.125	Traction	Rubber	350022-402-42	TR
18.00	6.00	12.125	Traction	Rubber	350022-404-41	CO
18.00	6.00	12.125	Traction	Rubber	350022-408-42	CS
18.00	6.00	12.125	SM	Rubber NM Cream	350022-412-41	TR
18.00	6.00	12.125	Traction	Rubber NM Cream	350022-412-42	TR
18.00	6.00	12.125	SM	Rubber NM Cream	350022-414-41	CO
18.00	6.00	12.125	SM	Rubber NM Grey	350022-418-41	CS
18.00	6.00	12.125	Traction	Rubber NM Grey	350022-418-42	CS
18.00	6.00	12.125	SM	FG	350022-421-41	RR
18.00	6.00	12.125	Traction	FG	350022-421-42	RR
18.00	6.00	12.125	SM	FG NM Black	350022-431-41	RR
18.00	6.00	12.125	Traction	FG NM Black	350022-431-42	RR
18.00	6.00	12.125	SM	FG NM White	350022-438-41	ML
18.00	7.00	12.125	SM	Rubber	137033-301-41	CS
18.00	7.00	12.125	Traction	Rubber	137033-301-42	CS
18.00	7.00	12.125	SM	Rubber	137033-305-41	CS
18.00	7.00	12.125	Traction	Rubber	137033-305-42	CS
18.00	7.00	12.125	SM	Rubber NM Grey	137033-311-41	CS
18.00	7.00	12.125	Traction	Rubber NM Grey	137033-311-42	CS
18.00	7.00	12.125	SM	Rubber NM Grey	137033-315-41	CS
18.00	7.00	12.125	Traction	Rubber NM Grey	137033-315-42	CS
18.00	7.00	12.125	SM	Rubber	350023-201-41	RR
18.00	7.00	12.125	Traction	Rubber	350023-201-42	RR
18.00	7.00	12.125	SM	Rubber NM Dk Grey	350023-211-41	RR
18.00	7.00	12.125	Traction	Rubber NM Dk Grey	350023-211-42	RR
18.00	7.00	12.125	SM	Rubber	350023-303-41	ML
18.00	7.00	12.125	Traction	Rubber	350023-303-42	ML
18.00	7.00	12.125	SM	Rubber NM Cream	350023-313-41	ML
18.00	7.00	12.125	SM	Rubber	350023-402-41	TR
18.00	7.00	12.125	Traction	Rubber	350023-402-42	TR
18.00	7.00	12.125	SM	Rubber	350023-404-41	CO
18.00	7.00	12.125	Traction	Rubber	350023-404-42	CO
18.00	7.00	12.125	SM	Rubber	350023-408-41	CS
18.00	7.00	12.125	Traction	Rubber	350023-408-42	CS
18.00	7.00	12.125	SM	Rubber NM Cream	350023-412-41	TR
18.00	7.00	12.125	Traction	Rubber NM Cream	350023-412-42	TR
18.00	7.00	12.125	SM	Rubber NM Cream	350023-414-41	CO
18.00	7.00	12.125	Traction	Rubber NM Cream	350023-414-42	CO
18.00	7.00	12.125	SM	Rubber NM Grey	350023-418-41	CS
18.00	7.00	12.125	Traction	Rubber NM Grey	350023-418-42	CS
18.00	7.00	12.125	SM	FG	350023-421-41	RR
18.00	7.00	12.125	Traction	FG	350023-421-42	RR
18.00	7.00	12.125	SM	Walnut	350023-429-41	ML
18.00	7.00	12.125	Traction	Walnut	350023-429-42	ML
18.00	7.00	12.125	Traction	FG NM Black	350023-431-42	RR
18.00	7.00	12.125	SM	Rubber	350023-450-41	CS
18.00	7.00	12.125	SM	Rubber NM Grey	350023-460-41	CS
18.00	8.00	12.125	SM	Rubber	137216-301-41	CS
18.00	8.00	12.125	Traction	Rubber	137216-301-42	CS
18.00	8.00	12.125	SM	Rubber NM Grey	137216-311-41	CS
18.00	8.00	12.125	Traction	Rubber NM Grey	137216-311-42	CS
18.00	8.00	12.125	SM	Rubber	350046-201-41	RR
18.00	8.00	12.125	Traction	Rubber	350046-201-42	RR
18.00	8.00	12.125	SM	Rubber NM Dk Grey	350046-211-41	RR
18.00	8.00	12.125	Traction	Rubber NM Dk Grey	350046-211-42	RR
18.00	8.00	12.125	SM	Rubber	350046-402-41	TR
18.00	8.00	12.125	SM	Rubber	350046-404-41	CO
18.00	8.00	12.125	Traction	Rubber	350046-408-42	CS
18.00	8.00	12.125	SM	Rubber NM Cream	350046-412-41	TR
18.00	8.00	12.125	SM	FG	350046-421-41	RR
18.00	8.00	12.125	Traction	FG	350046-421-42	RR

Rubber Tires by Size

Continued ▶

Note: Profile and manufacturer key on page 11.22.

18.00 O.D. Continued

Tire O.D.	Tire Width	Tire I.D.	Profile	Compound	Crown Part No.	Manuf.
18.00	8.00	12.125	Traction	Wire	350046-423-42	ML
18.00	8.00	12.125	SM	Walnut	350046-427-41	ML
18.00	8.00	12.125	Traction	Walnut	350046-427-42	ML
18.00	8.00	12.125	SM	Rubber	350046-450-41	CS
18.00	8.00	12.125	SM	Rubber NM Grey	350046-460-41	CS
18.00	9.00	12.125	SM	Rubber	350024-302-41	TR
18.00	9.00	12.125	Traction	Rubber	350024-302-42	TR
18.00	9.00	12.125	SM	Rubber NM Cream	350024-312-41	TR
18.00	9.00	12.125	Traction	Rubber NM Grey	350024-418-42	CS
20.00						
20.00	8.00	16.000	SM	Rubber	350025-408-41	CS
21.00						
21.00	6.00	15.000	Traction	Rubber	350027-302-42	TR
21.00	7.00	15.000	SM	Rubber	136019-301-41	CS
21.00	7.00	15.000	Traction	Rubber	136019-301-42	CS
21.00	7.00	15.000	SM	Rubber	136019-305-41	CS
21.00	7.00	15.000	Traction	Rubber	136019-305-42	CS
21.00	7.00	15.000	SM	Rubber NM Grey	136019-311-41	CS
21.00	7.00	15.000	Traction	Rubber NM Grey	136019-311-42	CS
21.00	7.00	15.000	SM	Rubber NM Grey	136019-315-41	CS
21.00	7.00	15.000	Traction	Rubber NM Grey	136019-315-42	CS
21.00	7.00	15.000	SM	Rubber	350047-201-41	RR
21.00	7.00	15.000	Traction	Rubber	350047-201-42	RR
21.00	7.00	15.000	SM	Rubber NM Dk Grey	350047-211-41	RR
21.00	7.00	15.000	Traction	Rubber NM Dk Grey	350047-211-42	RR
21.00	7.00	15.000	SM	Rubber	350047-303-41	ML
21.00	7.00	15.000	Traction	Rubber	350047-303-42	ML
21.00	7.00	15.000	SM	Rubber NM Cream	350047-313-41	ML
21.00	7.00	15.000	SM	Rubber	350047-402-41	TR
21.00	7.00	15.000	Traction	Rubber	350047-402-42	TR
21.00	7.00	15.000	SM	Rubber	350047-404-41	CO
21.00	7.00	15.000	Traction	Rubber	350047-404-42	CO
21.00	7.00	15.000	SM	Rubber	350047-408-41	CS
21.00	7.00	15.000	Traction	Rubber	350047-408-42	CS
21.00	7.00	15.000	SM	Rubber NM Cream	350047-412-41	TR
21.00	7.00	15.000	Traction	Rubber NM Cream	350047-412-42	TR
21.00	7.00	15.000	SM	Rubber NM Cream	350047-414-41	CO
21.00	7.00	15.000	Traction	Rubber NM Cream	350047-414-42	CO
21.00	7.00	15.000	SM	Rubber NM Grey	350047-418-41	CS
21.00	7.00	15.000	Traction	Rubber NM Grey	350047-418-42	CS
21.00	7.00	15.000	SM	FG	350047-421-41	RR
21.00	7.00	15.000	Traction	FG	350047-421-42	RR
21.00	7.00	15.000	SM	FG NM Black	350047-431-41	RR
21.00	7.00	15.000	Traction	FG NM Black	350047-431-42	RR
21.00	7.00	15.000	Traction	FG NM White	350047-438-43	ML
21.00	7.00	15.000	SM	Rubber	350047-450-41	CS
21.00	7.00	15.000	SM	Rubber NM Grey	350047-460-41	CS
21.00	8.00	15.000	SM	Rubber	137210-301-41	CS
21.00	8.00	15.000	Traction	Rubber	137210-301-42	CS
21.00	8.00	15.000	SM	Rubber	137210-305-41	CS
21.00	8.00	15.000	Traction	Rubber	137210-305-42	CS
21.00	8.00	15.000	SM	Rubber NM Grey	137210-311-41	CS
21.00	8.00	15.000	Traction	Rubber NM Grey	137210-311-42	CS
21.00	8.00	15.000	SM	Rubber NM Grey	137210-315-41	CS
21.00	8.00	15.000	Traction	Rubber NM Grey	137210-315-42	CS
21.00	8.00	15.000	SM	Rubber	350048-201-41	RR
21.00	8.00	15.000	Traction	Rubber	350048-201-42	RR
21.00	8.00	15.000	SM	Rubber NM Dk Grey	350048-211-41	RR
21.00	8.00	15.000	Traction	Rubber NM Dk Grey	350048-211-42	RR
21.00	8.00	15.000	SM	Rubber	350048-303-41	ML
21.00	8.00	15.000	Traction	Rubber	350048-303-42	ML
21.00	8.00	15.000	SM	Rubber NM Cream	350048-313-41	ML
21.00	8.00	15.000	SM	Rubber	350048-402-41	TR
21.00	8.00	15.000	Traction	Rubber	350048-402-42	TR
21.00	8.00	15.000	SM	Rubber	350048-404-41	CO
21.00	8.00	15.000	Traction	Rubber	350048-404-42	CO
21.00	8.00	15.000	Traction	Rubber	350048-408-42	CS
21.00	8.00	15.000	SM	Rubber NM Cream	350048-412-41	TR

Tire O.D.	Tire Width	Tire I.D.	Profile	Compound	Crown Part No.	Manuf.
21.00	8.00	15.000	Traction	Rubber NM Cream	350048-412-42	TR
21.00	8.00	15.000	SM	Rubber NM Cream	350048-414-41	CO
21.00	8.00	15.000	Traction	Rubber NM Cream	350048-414-42	CO
21.00	8.00	15.000	SM	Rubber NM Grey	350048-418-41	CS
21.00	8.00	15.000	Traction	Rubber NM Grey	350048-418-42	CS
21.00	8.00	15.000	SM	FG	350048-421-41	RR
21.00	8.00	15.000	Traction	FG	350048-421-42	RR
21.00	8.00	15.000	SM	FG NM Black	350048-431-41	RR
21.00	8.00	15.000	SM	FG NM White	350048-438-41	ML
21.00	8.00	15.000	Traction	FG NM White	350048-438-42	ML
21.00	8.00	15.000	SM	Rubber	350048-450-41	CS
21.00	8.00	15.000	SM	Rubber NM Grey	350048-460-41	CS
21.00	9.00	15.000	SM	Rubber	137211-301-41	CS
21.00	9.00	15.000	Traction	Rubber	137211-301-42	CS
21.00	9.00	15.000	SM	Rubber NM Grey	137211-311-41	CS
21.00	9.00	15.000	Traction	Rubber NM Grey	137211-311-42	CS
21.00	9.00	15.000	Traction	Rubber	350205-201-42	RR
21.00	9.00	15.000	SM	Rubber	350205-402-41	TR
21.00	9.00	15.000	SM	Rubber	350205-404-41	CO
21.00	9.00	15.000	Traction	Rubber	350205-404-42	CO
21.00	9.00	15.000	Traction	Rubber	350205-408-42	CS
21.00	9.00	15.000	SM	Rubber NM Cream	350205-412-41	TR
21.00	9.00	15.000	SM	Rubber NM Cream	350205-414-41	CO
21.00	9.00	15.000	Traction	Rubber NM Cream	350205-414-42	CO
21.00	9.00	15.000	SM	Rubber NM Grey	350205-418-41	CS
21.00	9.00	15.000	SM	Rubber	350205-450-41	CS
21.00	9.00	15.000	SM	Rubber NM Grey	350205-460-41	CS
22.00						
22.00	6.00	16.000	SM	Rubber	350065-408-41	CS
22.00	7.00	16.000	SM	Rubber	350068-408-41	CS
22.00	7.00	16.000	SM	Rubber NM Grey	350068-418-41	CS
22.00	7.00	16.000	Traction	Rubber NM Grey	350068-418-42	CS
22.00	8.00	16.000	Traction	Rubber	350039-302-42	TR
22.00	8.00	16.000	Traction	Rubber NM Cream	350039-312-42	TR
22.00	8.00	16.000	SM	Rubber	350039-402-41	TR
22.00	8.00	16.000	Traction	Rubber	350039-408-42	CS
22.00	8.00	16.000	SM	Rubber NM Cream	350039-412-41	TR
22.00	8.00	16.000	SM	Rubber NM Grey	350039-418-41	CS
22.00	8.00	16.000	Traction	Rubber NM Grey	350039-418-42	CS
22.00	8.00	16.000	SM	FG	350039-421-41	RR
22.00	8.00	16.000	Traction	FG	350039-421-42	RR
22.00	9.00	16.000	SM	Rubber	350029-201-41	RR
22.00	9.00	16.000	Traction	Rubber	350029-201-42	RR
22.00	9.00	16.000	SM	Rubber NM Dk Grey	350029-211-41	RR
22.00	9.00	16.000	Traction	Rubber NM Dk Grey	350029-211-42	RR
22.00	9.00	16.000	SM	Rubber	350029-402-41	TR
22.00	9.00	16.000	Traction	Rubber	350029-402-42	TR
22.00	9.00	16.000	SM	Rubber	350029-408-41	CS
22.00	9.00	16.000	Traction	Rubber	350029-408-42	CS
22.00	9.00	16.000	SM	Rubber NM Cream	350029-412-41	TR
22.00	9.00	16.000	Traction	Rubber NM Cream	350029-412-42	TR
22.00	9.00	16.000	SM	Rubber NM Grey	350029-418-41	CS
22.00	9.00	16.000	Traction	Rubber NM Grey	350029-418-42	CS
22.00	9.00	16.000	SM	FG	350029-421-41	RR
22.00	9.00	16.000	Traction	FG	350029-421-42	RR
22.00	10.00	16.000	SM	Rubber	350035-408-41	CS
22.00	10.00	16.000	Traction	Rubber	350035-408-42	CS
22.00	12.00	16.000	SM	Rubber	350037-402-41	TR
22.00	12.00	16.000	Traction	Rubber	350037-402-42	TR
22.00	12.00	16.000	SM	Rubber	350037-404-42	CO
22.00	12.00	16.000	SM	Rubber	350037-408-41	CS
22.00	12.00	16.000	Traction	Rubber	350037-408-42	CS
22.00	12.00	16.000	SM	Rubber NM Cream	350037-412-41	TR
22.00	12.00	16.000	Traction	Rubber NM Cream	350037-412-42	TR
22.00	12.00	16.000	SM	Rubber NM Grey	350037-418-41	CS
22.00	12.00	16.000	Traction	Rubber NM Grey	350037-418-42	CS
22.00	12.00	16.000	SM	Rubber	350037-450-41	CS
22.00	12.00	16.000	SM	Rubber NM Grey	350037-460-41	CS

WHEELS AND TIRES

Continued ▶

Rubber Tires by Size

Note: Profile and manufacturer key on page 11.22.

28.00 O.D.

Tire O.D.	Tire Width	Tire I.D.	Profile	Compound	Crown Part No.	Manuf.
28.00						
28.00	10.00	22.000	SM	Rubber	350069-408-41	CS
28.00	12.00	22.000	SM	Rubber	350030-402-41	TR
28.00	12.00	22.000	SM	Rubber	350030-408-41	CS
28.00	12.00	22.000	Traction	Rubber	350030-408-42	CS
28.00	12.00	22.000	SM	Rubber NM Grey	350030-418-41	CS
28.00	12.00	22.000	Traction	Rubber NM Grey	350030-418-42	CS
28.00	16.00	22.000	SM	Rubber	350070-408-41	CS

Sweeper Scrubber Rubber Tires

405



406



O.D.	Width	I.D.	Profile	Manufacturer	Compound	Crown Part No.
10.00	5.00	6.500	Diamond Sipe	Superior	P7	350007-406-05
12.00	4.50	8.000	Diamond Sipe	Superior	P7	350032-406-05
12.00	4.50	8.000	Smooth	Superior	P7	350032-406-41
13.50	5.50	8.000	Diamond Sipe	Superior	P7	350055-406-05
13.50	5.50	8.000	Smooth	Superior	P7	350055-406-41
16.00	3.50	12.125	Diamond Sipe	Superior	P7	350066-406-05
16.00	5.00	12.125	Diamond Sipe	Superior	P7	350056-406-05
16.00	5.00	12.125	Smooth	Superior	P7	350056-406-41
16.00	6.00	10.500	Diamond Sipe	Superior	P7	350054-406-05
16.00	6.00	10.500	Smooth	Superior	P7	350054-406-41
16.25	6.00	11.250	Lugged	Trelleborg/Monarch	Monogrip	350018-405-42
16.25	6.00	11.250	Diamond Sipe	Superior	P7	350018-406-05
16.25	6.00	11.250	Smooth	Superior	P7	350018-406-41
18.00	6.00	12.125	Diamond Sipe	Superior	P7	350022-406-05
18.00	6.00	12.125	Smooth	Superior	P7	350022-406-41

WARNING: Sweeper scrubber tires are only to be used on scrubber trucks as misapplication on a lift truck will affect stability and reduce the load capacity of forklift trucks by 30% or more.

Tread Reference Only



200



342

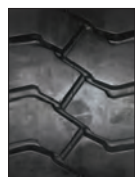

443



444

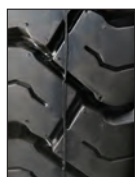

480, 481*,
490 & 491*



482 & 492



484*, 489*,
494* & 499*



486, 487*,
496 & 497*

Crown Part No.	Size	Tire O.D.	Tire Width	Rim Width	Profile	Notes	Manufacturer
Solid Resilient							
355158-480-42	15 x 4.5-8 (125/75-8)	14.80	4.40	3.00	Traction	Solid Resilient	Camso/ Solideal
355158-481-42	15 x 4.5-8 (125/75-8)	14.80	4.40	3.00	Traction	Solid Resilient	Camso/ Solideal
355158-491-42	15 x 4.5-8 (125/75-8)	14.80	4.50	3.00	Traction - NM Grey	Solid Resilient	Camso/ Solideal
155533-487-42	15 x 4.5-8 (125/75-8)	14.90	4.40	3.00	Traction	Solid Resilient	Camso/ Solideal
155533-497-42	15 x 4.5-8 (125/75-8)	14.80	4.50	3.00	Traction - NM Grey	Solid Resilient	Camso/ Solideal
155541-489-42	15 x 4.5-8 (125/75-8)	14.84	4.76	3.00	Traction	Solid Resilient	Continental
155541-499-42	15 x 4.5-8 (125/75-8)	14.84	4.76	3.00	Traction - NM Cream	Solid Resilient	Continental
155537-487-42	18 x 7-8	17.80	6.00	4.33	Traction	Solid Resilient	Camso/ Solideal
155537-497-42	18 x 7-8	17.80	6.00	4.33	Traction - NM Grey	Solid Resilient	Camso/ Solideal
155545-489-42	18 x 7-8	17.87	6.14	4.33	Traction	Solid Resilient	Continental
155545-499-42	18 x 7-8	17.87	6.14	4.33	Traction - NM Cream	Solid Resilient	Continental
355708-480-42	18 x 7-8	17.80	6.00	4.33	Traction	Solid Resilient	Camso/ Solideal
355708-481-42	18 x 7-8	17.80	6.00	4.33	Traction	Solid Resilient	Camso/ Solideal
355708-482-42	18 x 7-8	17.80	6.00	4.33	Traction	Solid Resilient	Trelleborg/Monarch
355708-491-42	18 x 7-8	17.90	6.20	4.33	Traction - NM Grey	Solid Resilient	Camso/ Solideal
355708-492-42	18 x 7-8	17.80	6.00	4.33	Traction - NM Cream	Solid Resilient	Trelleborg/Monarch
355610-482-42	21 x 8-9	20.30	7.30	6.00	Traction	Solid Resilient	Trelleborg/Monarch
355610-496-42	21 x 8-9	20.40	7.40	6.00	Traction - NM Grey	Solid Resilient	Camso/ Solideal
355239-481-42	23 x 9-10	23.00	7.90	6.50	Traction	Solid Resilient	Camso/ Solideal
355239-482-42	23 x 9-10	22.90	7.90	6.50	Traction	Solid Resilient	Trelleborg/Monarch
355239-487-42	23 x 9-10	23.00	7.80	6.50	Traction	Solid Resilient	Camso/ Solideal
355239-491-42	23 x 9-10	23.00	7.90	6.50	Traction - NM Grey	Solid Resilient	Camso/ Solideal
355023-481-42	23 x 10-12	23.00	9.10	8.00	Traction	Solid Resilient	Camso/ Solideal
355023-482-42	23 x 10-12	22.70	9.40	8.00	Traction	Solid Resilient	Trelleborg/Monarch
355023-487-42	23 x 10-12	23.10	9.20	8.00	Traction	Solid Resilient	Camso/ Solideal
355023-491-42	23 x 10-12	23.00	9.10	8.00	Traction - NM Grey	Solid Resilient	Camso/ Solideal
355023-492-42	23 x 10-12	22.70	9.40	8.00	Traction - NM Cream	Solid Resilient	Trelleborg/Monarch
355250-480-42	250-15	28.30	8.70	7.00	Traction	Solid Resilient	Camso/ Solideal
355250-481-42	250-15	28.30	8.70	7.00	Traction	Solid Resilient	Camso/ Solideal
355250-482-42	250-15	27.90	9.10	7.00	Traction	Solid Resilient	Trelleborg/Monarch
355250-491-42	250-15	28.30	8.60	7.00	Traction - NM Grey	Solid Resilient	Camso/ Solideal
355255-480-42	250-15	28.20	8.90	7.50	Traction	Solid Resilient	Camso/ Solideal
155539-487-42	200/50-10	18.00	7.60	6.50	Traction	Solid Resilient	Camso/ Solideal
155539-497-42	200/50-10	18.00	7.60	6.50	Traction - NM Grey	Solid Resilient	Camso/ Solideal
155547-489-42	200/50-10	17.80	7.72	6.50	Traction	Solid Resilient	Continental
155547-499-42	200/50-10	17.80	7.72	6.50	Traction - NM Cream	Solid Resilient	Continental
355200-481-42	200/50-10	18.00	7.60	6.50	Traction	Solid Resilient	Camso/ Solideal
355200-482-42	200/50-10	17.80	7.90	6.50	Traction	Solid Resilient	Trelleborg/Monarch
355200-492-42	200/50-10	18.00	7.80	6.50	Traction - NM Cream	Solid Resilient	Trelleborg/Monarch
355400-381-42	4.00-8	16.00	4.80	3.75	Traction - Rib	Solid Resilient	Camso/ Solideal
355500-480-42	5.00-8	17.80	4.60	3.00	Traction	Solid Resilient	Camso/ Solideal
355500-482-42	5.00-8	17.80	4.70	3.00	Traction	Solid Resilient	Trelleborg/Monarch
355500-484-42	5.00-8	18.07	4.96	3.00	Traction	Solid Resilient	Continental
355500-486-42	5.00-8	17.90	4.60	3.00	Traction	Solid Resilient	Camso/ Solideal
355500-490-42	5.00-8	17.80	4.60	3.00	Traction - NM Grey	Solid Resilient	Camso/ Solideal
355500-492-42	5.00-8	17.80	4.70	3.00	Traction - NM Cream	Solid Resilient	Trelleborg/Monarch
355508-381-42	5.00-8	17.80	5.30	3.75	Traction - Rib	Solid Resilient	Camso/ Solideal
156783-484-42	6.00-9	20.83	5.63	4.00	Traction	Solid Resilient	Continental
156783-485-42	6.00-9	21.40	5.90	4.00	Traction	Solid Resilient	Nex Tire
156783-487-42	6.00-9	20.60	5.30	4.00	Traction	Solid Resilient	Camso/ Solideal
156783-494-42	6.00-9	20.83	5.63	4.00	Traction - NM Cream	Solid Resilient	Continental
156783-497-42	6.00-9	20.60	5.30	4.00	Traction - NM Grey	Solid Resilient	Camso/ Solideal
355609-480-42	6.00-9	20.70	5.30	4.00	Traction	Solid Resilient	Camso/ Solideal
355609-481-42	6.00-9	20.70	5.30	4.00	Traction	Solid Resilient	Camso/ Solideal
355609-482-42	6.00-9	20.60	5.50	4.00	Traction	Solid Resilient	Trelleborg/Monarch
355609-492-42	6.00-9	20.60	5.60	4.00	Traction - NM Cream	Solid Resilient	Trelleborg/Monarch
355609-486-42	6.00-9	20.60	5.30	4.00	Traction	Solid Resilient	Camso/ Solideal
355609-490-42	6.00-9	20.70	5.30	4.00	Traction - NM Grey	Solid Resilient	Camso/ Solideal

*These tires include the built-in lock ring (Quick/SIT Tires) – 481, 484, 487, 489, 491, 494, 497 & 499

WHEELS AND TIRES

Crown Part No.	Size	Tire O.D.	Tire Width	Rim Width	Profile	Notes	Manufacturer
Solid Resilient (continued)							
156781-484-42	6.50-10	22.68	6.38	5.00	Traction	Solid Resilient	Continental
156781-485-42	6.50-10	23.70	6.20	5.00	Traction	Solid Resilient	Nex Tire
156781-487-42	6.50-10	22.40	6.20	5.00	Traction	Solid Resilient	Camso/ Solideal
156781-494-42	6.50-10	22.68	6.38	5.00	Traction - NM Cream	Solid Resilient	Continental
156781-497-42	6.50-10	22.40	6.20	5.00	Traction - NM Grey	Solid Resilient	Camso/ Solideal
355650-381-41	6.50-10	22.30	6.20	5.00	Smooth	Solid Resilient	Camso/ Solideal
355650-480-42	6.50-10	22.30	6.20	5.00	Traction	Solid Resilient	Camso/ Solideal
355650-481-42	6.50-10	22.30	6.20	5.00	Traction	Solid Resilient	Camso/ Solideal
355650-482-42	6.50-10	22.40	6.40	5.00	Traction	Solid Resilient	Trelleborg/Monarch
355650-486-42	6.50-10	22.40	6.20	5.00	Traction	Solid Resilient	Camso/ Solideal
355650-490-42	6.50-10	22.30	6.20	5.00	Traction - NM Grey	Solid Resilient	Camso/ Solideal
355650-492-42	6.50-10	22.40	6.40	5.00	Traction - NM Cream	Solid Resilient	Trelleborg/Monarch
355650-496-42	6.50-10	22.40	6.20	5.00	Traction - NM Grey	Solid Resilient	Camso/ Solideal
156779-484-42	7.00-12	25.87	6.81	5.00	Traction	Solid Resilient	Continental
156779-485-42	7.00-12	27.36	6.80	5.00	Traction	Solid Resilient	Nex Tire
156779-487-42	7.00-12	25.70	6.50	5.00	Traction	Solid Resilient	Camso/ Solideal
156779-494-42	7.00-12	25.87	6.81	5.00	Traction - NM Cream	Solid Resilient	Continental
156779-497-42	7.00-12	25.60	6.60	5.00	Traction - NM Grey	Solid Resilient	Camso/ Solideal
355712-480-42	7.00-12	25.70	6.50	5.00	Traction	Solid Resilient	Camso/ Solideal
355712-481-42	7.00-12	25.70	6.50	5.00	Traction	Solid Resilient	Camso/ Solideal
355712-482-42	7.00-12	25.50	6.90	5.00	Traction	Solid Resilient	Trelleborg/Monarch
355712-490-42	7.00-12	25.70	6.50	5.00	Traction - NM Grey	Solid Resilient	Camso/ Solideal
355712-492-42	7.00-12	25.50	6.90	5.00	Traction - NM Cream	Solid Resilient	Trelleborg/Monarch
355712-486-42	7.00-12	25.70	6.50	5.00	Traction	Solid Resilient	Camso/ Solideal
355715-480-42	7.00-15	28.50	6.90	5.50	Traction	Solid Resilient	Camso/ Solideal
156777-484-42	8.15-15 or 28 x 9-15 or 225/75-15	27.28	8.50	7.00	Traction	Solid Resilient	Continental
156777-485-42	8.15-15 or 28 x 9-15 or 225/75-15	28.72	8.94	7.00	Traction	Solid Resilient	Nex Tire
156777-487-42	8.15-15 or 28 x 9-15 or 225/75-15	27.10	8.40	7.00	Traction	Solid Resilient	Camso/ Solideal
156777-494-42	8.15-15 or 28 x 9-15 or 225/75-15	27.28	8.50	7.00	Traction - NM Cream	Solid Resilient	Continental
156777-497-42	8.15-15 or 28 x 9-15 or 225/75-15	27.10	8.40	7.00	Traction - NM Grey	Solid Resilient	Camso/ Solideal
355815-480-42	8.15-15 or 28 x 9-15 or 225/75-15	27.10	8.40	7.00	Traction	Solid Resilient	Camso/ Solideal
355815-481-42	8.15-15 or 28 x 9-15 or 225/75-15	27.10	8.40	7.00	Traction	Solid Resilient	Camso/ Solideal
355815-482-42	8.15-15 or 28 x 9-15 or 225/75-15	27.00	8.70	7.00	Traction	Solid Resilient	Trelleborg/Monarch
355815-486-42	8.15-15 or 28 x 9-15 or 225/75-15	27.10	8.40	7.00	Traction	Solid Resilient	Camso/ Solideal
355815-490-42	8.15-15 or 28 x 9-15 or 225/75-15	27.10	8.40	7.00	Traction - NM Grey	Solid Resilient	Camso/ Solideal
355815-492-42	8.15-15 or 28 x 9-15 or 225/75-15	27.00	8.70	7.00	Traction - NM Cream	Solid Resilient	Trelleborg/Monarch
355826-480-42	8.25-15	31.90	8.20	6.50	Traction	Solid Resilient	Camso/ Solideal
355826-481-42	8.25-15	31.90	8.20	6.50	Traction	Solid Resilient	Camso/ Solideal
355826-482-42	8.25-15	31.70	8.30	6.50	Traction	Solid Resilient	Trelleborg/Monarch
355826-486-42	8.25-15	32.00	8.30	6.50	Traction	Solid Resilient	Camso/ Solideal
355826-487-42	8.25-15	32.00	8.30	6.50	Traction	Solid Resilient	Camso/ Solideal
355826-490-42	8.25-15	31.90	8.20	6.50	Traction - NM Grey	Solid Resilient	Camso/ Solideal
355300-480-42	3.00-15	32.00	9.90	8.00	Traction	Solid Resilient	Camso/ Solideal
355300-482-42	3.00-15	31.80	10.10	8.00	Traction	Solid Resilient	Trelleborg/Monarch
355920-381-42	9.00-20	38.30	8.80	7.00	Traction	Solid Resilient	Camso/ Solideal
355122-480-42	12.00-20	42.90	11.10	8.50	Traction	Solid Resilient	Camso/ Solideal
148737-487-42	27 x 10-12	26.80	9.50	8.00	Traction	Solid Resilient	Camso/ Solideal
148737-497-42	27 x 10-12 (250/75-12)	26.80	9.50	8.00	Traction - NM Grey	Solid Resilient	Camso/ Solideal
355027-481-42	27 x 10-12	26.80	9.50	8.00	Traction	Solid Resilient	Camso/ Solideal
355027-491-42	27 x 10-12	26.80	9.50	8.00	Traction - NM Grey	Solid Resilient	Camso/ Solideal
148740-487-42	28 x 12.5-15 (355/45-15)	27.20	11.30	9.75	Traction	Solid Resilient	Camso/ Solideal
148740-497-42	28 x 12.5-15 (355/45-15)	27.20	11.30	9.75	Traction - NM Grey	Solid Resilient	Camso/ Solideal
155535-487-42	140/55-9	14.80	5.10	4.00	Traction	Solid Resilient	Camso/ Solideal
155535-497-42	140/55-9	14.80	5.10	4.00	Traction - NM Grey	Solid Resilient	Camso/ Solideal
155543-489-42	140/55-9	14.84	5.16	4.00	Traction	Solid Resilient	Continental
155543-499-42	140/55-9	14.84	5.16	4.00	Traction - NM Cream	Solid Resilient	Continental
355140-481-42	140/55-9	14.90	5.10	4.00	Traction	Solid Resilient	Camso/ Solideal

*These tires include the built-in lock ring (Quick/SIT Tires) – 481, 484, 487, 489, 491, 494, 497 & 499

Resilient/Pneumatic Tires

Crown Part No.	Size	Tire O.D.	Tire Width	Rim Width	Ply	Profile	Notes	Manufacturer
Air Pneumatic								
355250-444-42-16	250-15 (250/70-15)	28.90	9.40	7.50	16	Traction	Air Pneumatic	Camso/ Solideal
350500-342-42	5.00-8	18.40	5.50	3.00	10	Traction	Air Pneumatic	Trelleborg/Monarch
355508-444-42-08	5.00-8	18.40	5.20	3.00	8	Traction	Air Pneumatic	Camso/ Solideal
355609-342-42	6.00-9	21.40	6.30	4.00	12	Traction	Air Pneumatic	Trelleborg/Monarch
163060-444-42-12	6.00-9	21.10	6.30	4.00	12	Traction	Air Pneumatic	Camso/ Solideal
355609-444-42-10	6.00-9	21.00	6.50	4.00	10	Traction	Air Pneumatic	Camso/ Solideal
163059-444-42-14	6.50-10	23.10	7.10	5.00	14	Traction	Air Pneumatic	Camso/ Solideal
355650-444-42-10	6.50-10	23.20	7.00	5.00	10	Traction	Air Pneumatic	Camso/ Solideal
163058-444-42-16	7.00-12	26.30	7.50	5.00	16	Traction	Air Pneumatic	Camso/ Solideal
355712-342-42	7.00-12	26.80	7.50	5.00	14	Traction	Air Pneumatic	Trelleborg/Monarch
355712-444-42-12	7.00-12	26.60	7.60	5.00	12	Traction	Air Pneumatic	Camso/ Solideal
355712-444-42-14	7.00-12	26.70	7.60	5.00	14	Traction	Air Pneumatic	Camso/ Solideal
355715-342-42	7.00-15	29.90	8.00	5.50	14	Traction	Air Pneumatic	Trelleborg/Monarch
355715-444-42-14	7.00-15	30.00	8.00	5.50	14	Traction	Air Pneumatic	Camso/ Solideal
355716-444-42-12	7.50-16	31.90	8.20	6.00	12	Traction	Air Pneumatic	Camso/ Solideal
163057-444-42-14	8.15-15 or 28 x 9-15	28.00	8.90	7.00	14	Traction	Air Pneumatic	Camso/ Solideal
355825-342-42	8.25-15	33.10	9.70	6.50	14	Traction	Air Pneumatic	Trelleborg/Monarch
355825-443-42	8.25-15	33.10	9.70	6.50	14	Traction	Air Pneumatic	Camso/ Solideal
355825-444-42-14	8.25-15	33.30	9.90	6.50	14	Traction	Air Pneumatic	Camso/ Solideal
355920-342-42-14	9.00-20	40.00	10.40	7.00	14	Traction	Air Pneumatic	Trelleborg/Monarch
355920-444-42-14	9.00-20	41.20	11.30	7.00	14	Traction	Air Pneumatic	Camso/ Solideal
355300-444-42-18	300-15 (315/70-15)	32.80	11.30	8.00	18	Traction	Air Pneumatic	Camso/ Solideal
355300-443-42-18	300-15 (315/70-15)	33.50	10.90	8.00	18	Traction	Air Pneumatic	Camso/ Solideal
355032-443-42	32x12.1-15 (355/65-15)	31.70	12.40	9.75	24	Traction	Air Pneumatic	Camso/ Solideal

Please note: All Air Pneumatics include the Tire, Flaps, and Tubes.

Tubes

Crown Part No.	Tire Size	Manufacturer	Crown Part No.	Tire Size	Manufacturer	Crown Part No.	Tire Size	Manufacturer
315000-250	2.50 x 15	Camso	136247	6.00 x 9	Camso	315000-715	7.00 x 15	Camso
315000-408	4.00 x 8	Camso	315000-650	6.50 x 10	Camso	315000-815	8.15 x 15	Camso
315000-508	5.00 x 8	Camso	136243	7.00 x 12	Camso			

Flaps

Crown Part No.	Tire Size	Manufacturer
141518-001	400/500/570 x 8	Camso
141518-002	16 x 6-8	Camso

Rims

Crown Part No.	Rim Size	Tire Size	Manufacturer	Crown Part No.	Rim Size	Tire Size	Manufacturer
153995**	3.00 D-8	125/75-8 3.0"	Continental	149641	5.00 S-12	7.00-12 5.0"	Camso
153998**	4.00 E-9	140/55-9 4.0"	Continental	157351**	5.00 S-12	7.00-12 5.0"	Continental
152564*	4.00 E-9	140/55-9 4.0"	Camso	156785*	5.00 S-12	7.00-12 5.0"	Camso
136246	4.00 E-9	6.00-9 4.0"	Camso	152570*	6.50 F-10	200/50-10 6.5"	Camso
157342**	4.00 E-9	6.00-9 4.0"	Continental	154004**	6.50 F-10	200/50-10 6.5"	Continental
156792*	4.00 E-9	6.00-9 4.0"	Camso	157345**	7.00-15	225/75-15 7.0"	Continental
113041	4.33 R-8	16x6-8, 17x7-8, 18x7-8	Trelleborg	156784*	7.00-15	28x9-15 7.0"	Camso
152567*	4.33 R-8	18x7-8 4.33"	Camso	142934	7.10-15	28x9-15 7.0"	Camso
154001**	4.33 R-8	18x7-8 4.33"	Continental	113042	8.00 G-12	23x10-12, 27x10-12	Trelleborg
156786*	5.00 F-10	6.50-10 5.0"	Camso	148738*	8.00 G-12	27x10-12 8.0"	Camso
143317	5.00 F-10	6.50-10 5.0"	Camso	148741*	9.75-15	355/45-15 9.75"	Camso
157348**	5.00 F-10	6.50-10 5.0"	Continental				

*Quick Tire Only (lock ring imbedded into the tire)
 **SIT Tire Only (lock ring imbedded into the tire)

One Source Hubs



358008



380030-144



358007



358010



358014



358015



358004



358003

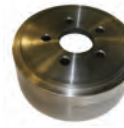

370508



358013



358009



370061

Part No.	Dimensions	OE	OE Number	Truck Model	Bolts
358008		Caterpillar/ Mitsubishi	91E43-10800 91E43-20800	FD20/25/28/30/33/35, FG20/25/28/30/33/35, P4000, P5000, P5500, P6000, P6500, P7000	
358016		Hyster	524139975	B60Z/80Z, C60Z/80Z, T5Z/T7Z, W20ZR/25ZC/30ZA/30ZC/30ZR/4 0ZA/40ZC/60Z/65Z/80Z	5 Bolt Hub
380030-144		Hyster	2021797	H25XMD, H30XMD, H35XMD, H40XMD	
370061	5 x 2.5	Hyster	2308186	B60Z	
358007		Komatsu	3EB-21-32171	FD20,23,25,28,30-12, FG20/C/H/HT/T, 23/T, 25/C/H/HT/T, 28/T, 30/C/H/HT/T - 12,14	
358010		Komatsu	3EB-24-21210	FB20/25/30/30 SH-4, FD20/23/25/25S,28,30-11,12, FG20/C/H/ HT/S/T,23/T,25/C/H/HT/S/T,28/T,30/C/H/HT/S/T -11,12,14	
358014		Komatsu	3EB-21-52320		
358015		Nissan	43204-FJ101		
358004	6.25 x 7	Raymond	123-000-586	630, 640, 650 Counterbalance Trucks	Steer Hub
358003	6.5 x 3.3	Raymond	850-138-111	109, 111, 112, 113, 114 Pallet Jacks, 111, 112, 113, 114 Walkies	5 Bolt Hub
370508	8 x 3.54	Raymond	1133708	3010 & 3020 Series Raymond Courier Automated Pallet Trucks	5 Bolt Hub
	8.99 x 4.98	Raymond	114-008-501	Easi Order Picker	5 Bolt Raised Lip Dr. Hub
	10.5 x 4.44	Raymond	828-003-073	Easi Reach, Easi Order Picker	"7 Bolt Concave Hub; lug bolt EZ Reach 370547"
358013	11.25 x 6	Raymond	223-001-153/002	Pacer	8 Bolt Hub
358009		Toyota	43811-20540-71	02-5FD,FDU/20/23/25/28/30, 02-5FG28/30, 40-4FG20/25, 40-5FG20/23/25, 42-2FG,4FG/20/25, 42-5FG,FGU/20/23/25, 5FD,FG/20/23/25/28/30, 8FDU,FGU20/25/30/32	
358016		Yale	2038719	MCW025/030/040, MPC060/080, MPE060/080, MPW060/ 065/080, MRW020/030/040	5 Bolt Hub
380030-144		Yale	9063996-00	GC030, GC040, GDP030, GDP040, GLC030, GLP030, GLP040, GP030, GP040, GTP030	
370061	5 x 2.5	Yale	501087300	MPB040	

Hubs



Crown Hubs

Hub Part Number	Tire	Steer/ Drive	Truck Model
138111	141058	Steer	C5 Cushion
140796	136019/ 137210	Drive	C5 Cushion
117444	135906/ 136162	Steer	C5 Cushion, FC 4000/4500
128375	136019/ 137210	Drive	C5 Cushion, FC 4000/4500
121973	136019	Drive	FC 4000/4500
113361	079494	Drive	PE 4000, PR/PC 4500
113362	074458	Drive	PE 4000, PC/PR 4500
076752	076751	Steer	RC 3000
114981	114493	Drive	RC 3000
116561	077848	Steer	RC 3000
126267	126266	Steer	RC 3000
134825	107933	Steer	RC 5500
140692	135906	Drive	RC 5500 Original Hub
162148	135906	Drive	RC 5500/5700 Hub without center cap
115025	079266	Drive	RR 3000, TSP 6000/ 6500/7000, TSP 1000/1500
121502	121501	Drive	RR/RD 5700/5200/5000
124300	137033	Drive	SC 4000/4500
124798	137216	Drive	SC 4000/4500
146015	137031	Steer	SC 4000/4500/5200
147717	137033	Drive	SC 5200 Original Hub (cushion only)
162146	137033	Drive	SC 5200/5700 Hub without center cap (cushion only)
087391	079266	Drive	SP 3000/3200/3500/3400 3 wheel/ 3400 4 wheel
090723	079266/ 074458/ 077050/ 079494/ 093226/ 093225	Drive	SP 36/42/48, PC, PE, PR, PW, WB, W(HD), WR, TW, TWR, TR, SSR
157102	133753	Drive	TSP 6000/6500/7000, TSP 1000/1500



Tire Chains

Forklift Tire Chains

Crown Part Number - Pair	Tire Sizes					Weight Per Pair
355900-001	6.50-10					15
355900-002	7.00-12	7.50-10	23x10-12	250/60-12		19
355900-003	7.00-15	28x9-15	8.15-15	225/75-15	29x8-15	20
355900-005	250-15	250/70-15				22
355900-006	8.25-15	7.50-15(32)				28
355900-010	300-15	315/70-15	355/45-15	28x12.5-15		30

⚠️ **WARNING:** Cancer and reproductive harm - www.P65Warnings.ca.gov



Forklift Tire Chains

- Square 4-link alloy cross chains



Light Truck Tire Chains

- 5.5mm square straight link alloy chains
- Increased durability and traction
- Reversible for extended use on both sides

Light Truck Tire Chains

Crown Part Number - Pair	Tire Sizes						Weight Per Pair
355901-005	PR78-15	33x13.5-15	265/75R16LT	12-16.5LT	32x11.5-15LT	225/70R19.5LT	27
	8.25-15TR	34x9.50-15	275/70R16LT	31x10.5-16.5	255/85R16LT	245/70R19.5LT	
	11-15LT	PR78-16	32x11.5x16	P275/60R17	34x9x16	275/55R20	
	31x11.5-15LT	P265/70R16	33x13.5-16	265/70R17LT	10-17.5	275/60R20	
355901-006	12-15LT	33x14x15	11L16	35x13.5-16	32x12.50R15	325/60R18	31
	P315/70R15	33x14.5-15	285/75R16LT	36x13x16	35x14.5-15	35x12.5-17	
	31x13.50-15	35x13.5-15	295/75R16	33x12.50R16.5	305/85R16LT	300-15	

⚠️ **WARNING:** Cancer and reproductive harm - www.P65Warnings.ca.gov

OE Number	Crown Base Part No.	Description
Allis Chalmers (AC)		
105	310077	Wheel 3.25x5.88x2.047x0.599
202	310078	Wheel 3.25x2.88x2.047x0.59
204	310080	Wheel 3x2x2.047x0.625
301	073961	Wheel 4x2.88x2.047x0.59
302	310164	Wheel 5x2.88x2.047x0.59
304	310154	Wheel 6x3.94x2.872x1.224
306	310160	Wheel 5x3.63x2.44x0.668
353	071894	Wheel 4x2.06x1.189
653	310244	Wheel 3.25x4.5x2.047x.594
981	310102	Wheel 5x3.62x2.834x0.76
983	310077	Wheel 3.25x5.88x2.047x0.599
986	310154	Wheel 6x3.94x2.872x1.224
987	310078	Wheel 3.25x2.88x2.047x0.59
989	077086	Wheel 3.25x5x2.047x0.59
9812	310077	Wheel 3.25x5.88x2.047x0.599
9824	310080	Wheel 3x2x2.047x0.625
9827	310164	Wheel 5x2.88x2.047x0.59
9828	310101	Wheel 3.38x2.63x1.979x1.242
9851	310244	Wheel 3.25x4.5x2.047x.594
9862	310160	Wheel 5x3.63x2.44x0.668
9870	310164	Wheel 5x2.88x2.047x0.59
605035	310077	Wheel 3.25x5.88x2.047x0.599
4814152	073961	Wheel 4x2.88x2.047x0.59
4814484	310101	Wheel 3.38x2.63x1.979x1.242
4816552	073961	Wheel 4x2.88x2.047x0.59
4826270	310164	Wheel 5x2.88x2.047x0.59
4826279	310164	Wheel 5x2.88x2.047x0.59
4854131	081645	Wheel Poly
4865875	310132	Wheel 6x3x2.047x0.595
4876612	310077	Wheel 3.25x5.88x2.047x0.599
4878390	310082	Wheel 6x2.4x1.979x0.8800
4879331	310087	Wheel 7x2.86x2.047xNon Typical
4900617	310102	Wheel 5x3.62x2.834x0.76
4910260	073961	Wheel 4x2.88x2.047x0.59
4930044	310087	Wheel 7x2.86x2.047xNon Typical
4930101	310164	Wheel 5x2.88x2.047x0.59
4930836	310102	Wheel 5x3.62x2.834x0.76
4932096	310077	Wheel 3.25x5.88x2.047x0.599
4932226	310077	Wheel 3.25x5.88x2.047x0.599
4934289	083179	Wheel 4x2.50x2.047x0.59
4972095	083179	Wheel 4x2.50x2.047x0.59
8611635	310078	Wheel 3.25x2.88x2.047x0.59
8611657	310077	Wheel 3.25x5.88x2.047x0.599
8612234	310077	Wheel 3.25x5.88x2.047x0.599
8623144	310155	Wheel 7x2.5x2.326xNon Typical
8623929	310101	Wheel 3.38x2.63x1.979x1.242
8730186	077086	Wheel 3.25x5x2.047x0.59
8730459	310085	Wheel 3.25x6x2.047x0.585
8730461	310147	Wheel 3.25x6x2.047x1.187
8731313	310155	Wheel 7x2.5x2.326xNon Typical
8731340	310102	Wheel 5x3.62x2.834x0.76
8732658	310154	Wheel 6x3.94x2.872x1.224
8733670	310227	Wheel 7x2.75x1.98
8733671	310227	Wheel 7x2.75x1.98
8733981	310227	Wheel 7x2.75x1.98
49306145	310160	Wheel 5x3.63x2.44x0.668
74814152	073961	Wheel 4x2.88x2.047x0.59
74814484	310077	Wheel 3.25x5.88x2.047x0.599
74816552	073961	Wheel 4x2.88x2.047x0.59
74826270	310087	Wheel 7x2.86x2.047xNon Typical
74826279	310090	Wheel 8x2x2.047x0.595
74850520	310132	Wheel 6x3x2.047x0.595
74854131	310078	Wheel 3.25x2.88x2.047x0.59
74865815	310154	Wheel 6x3.94x2.872x1.224
74865875	310154	Wheel 6x3.94x2.872x1.224
74876612	310077	Wheel 3.25x5.88x2.047x0.599
74878390	073961	Wheel 4x2.88x2.047x0.59

OE Number	Crown Base Part No.	Description
74879331	310090	Wheel 8x2x2.047x0.595
74900617	310102	Wheel 5x3.62x2.834x0.76
74930614	310087	Wheel 7x2.86x2.047xNon Typical
749306145	071894	Wheel 4 Poly
74930744	310164	Wheel 5x2.88x2.047x0.59
74931496	310080	Wheel 3x2x2.047x0.625
74932910	310235	Wheel 4x2.88x2.44x0.672
74934289	083179	Wheel 4x2.50x2.047x0.59
74972095	083179	Wheel 4x2.50x2.047x0.59
78612234	310077	Wheel 3.25x5.88x2.047x0.599
78623929	310101	Wheel 3.38x2.63x1.979x1.242
78730461	310077	Wheel 3.25x5.88x2.047x0.599
78731313	310164	Wheel 5x2.88x2.047x0.59
78731340	310102	Wheel 5x3.62x2.834x0.76
78731798	310087	Wheel 7x2.86x2.047xNon Typical
78734185	310244	Wheel 3.25x4.5x2.047x.594
S653	310244	Wheel 3.25x4.5x2.047x.594
S654	073961	Wheel 4x2.88x2.047x0.59
S976	310164	Wheel 5x2.88x2.047x0.59
S977	310160	Wheel 5x3.63x2.44x0.668
S979	310102	Wheel 5x3.62x2.834x0.76
S981	310102	Wheel 5x3.62x2.834x0.76
S983	310077	Wheel 3.25x5.88x2.047x0.599
S986	310155	Wheel 7x2.5x2.326xNon Typical
S987	310078	Wheel 3.25x2.88x2.047x0.59
S988	310087	Wheel 7x2.86x2.047xNon Typical
S991	310080	Wheel 3x2x2.047x0.625
S992	310080	Wheel 3x2x2.047x0.625
S994	310101	Wheel 3.38x2.63x1.979x1.242
S995	071894	Wheel 4 Poly
Atlas (AT)		
9433	310189	Wheel 3x3.5x1.85x0.56
Baker (BK)		
0009902353	807557	Drive Tire Assembly ESR4500
1064596	807557	Drive Tire Assembly ESR4500
114421	310142	Wheel 4x2.88x2.44x0.75
115311	310133	Wheel 5x2.88x2.44x0.775
138074	310094	Wheel 4x2x1.575x0.575
138938	310133	Wheel 5x2.88x2.44x0.775
139064	310146	Wheel 3.25x6.38x2.047x0.812
139840	310146	Wheel 3.25x6.38x2.047x0.812
146158	310146	Wheel 3.25x6.38x2.047x0.812
529	310144	Wheel 3.25x6x2.047x0.812
704152	310140	Wheel 3.25x3.88x2.047x.812
704522	310141	Wheel 3.25x3x2.047x0.812
705720	310094	Wheel 4x2x1.575x0.575
707100	310142	Wheel 4x2.88x2.44x0.75
708076	310146	Wheel 3.25x6.38x2.047x0.812
708077	310142	Wheel 4x2.88x2.44x0.75
708078	310133	Wheel 5x2.88x2.44x0.775
708372	310140	Wheel 3.25x3.88x2.047x.812
984075	310141	Wheel 3.25x3x2.047x0.812
984840	310146	Wheel 3.25x6.38x2.047x0.812
984841	310149	Wheel 3.25x3x2.047x0.656
984842	310190	Wheel 3.25x6.38x2.047x1.187
985604	310141	Wheel 3.25x3x2.047x0.812
992628	310185	Wheel 3.25x4.5x1.575x0.56
993470	073961	Wheel 4x2.88x2.047x0.59
993472	073961	Wheel 4x2.88x2.047x0.59
994070	310179	Wheel 8x4x2.44x0.656
9902353	807557	Drive Tire Assembly ESR4500
314X6	310144	Wheel 3.25x6x2.047x0.812
8X4	310179	Wheel 8x4x2.44x0.656
AW-3-4	310179	Wheel 8x4x2.44x0.656
AW-4-1	310179	Wheel 8x4x2.44x0.656
BHP-014	310189	Wheel 3x3.5x1.85x0.56
BKAW-3-4	310179	Wheel 8x4x2.44x0.656
BKAW-4-1	310179	Wheel 8x4x2.44x0.656

Note: Add the compound part number to the base number listed above. Wheel compounds listed on page 11.03 (Format: XXXXXX-XXX.) and tire compounds and treads listed on page 11.19 (Format: XXXXXX-XXX-XX).

Baker Continued ▶

Wheel & Tire Cross References

Continued ▶

Baker Continued

OE Number	Crown Base Part No.	Description
BKW3-4G	073961	Wheel 4x2.88x2.047x0.59
L0009902353	807557	Drive Tire Assembly ESR4500
M0106SPEC	310147	Wheel 3.25x6x2.047x1.187
P30W	310185	Wheel 3.25x4.5x1.575x0.56
PAL-13	310145	Wheel 3.25x6.25x2.047x0.812
PAL-13-C	310141	Wheel 3.25x3x2.047x0.812
PAL-13-D	310141	Wheel 3.25x3x2.047x0.812
PAL-13GH	310140	Wheel 3.25x3.88x2.047x.812
PAL-13-GLD	310141	Wheel 3.25x3x2.047x0.812
PAL-13K	310140	Wheel 3.25x3.88x2.047x.812
PAL-13KG	310140	Wheel 3.25x3.88x2.047x.812
PAL-13M	310144	Wheel 3.25x6x2.047x0.812
PAL-43-A	310141	Wheel 3.25x3x2.047x0.812
W34	073961	Wheel 4x2.88x2.047x0.59
W3-4	073961	Wheel 4x2.88x2.047x0.59
W34A	073961	Wheel 4x2.88x2.047x0.59
W3-4A	073961	Wheel 4x2.88x2.047x0.59
W3-4G	073961	Wheel 4x2.88x2.047x0.59
Barrett (BR)		
106	310144	Wheel 3.25x6x2.047x0.812
110	310084	Wheel 3.25x6x1.98x0.912
115	310210	Wheel 3.25x5.5x1.98x0.69
201	310193	Wheel 4x2.75x1.78x0.72
203	310181	Wheel 4x2.88x2.44x0.832
205	310195	Wheel 5x2.87x1.78x0.80
228	310194	Wheel 3.25x2.88x1.98xNon Typical
234	310193	Wheel 4x2.75x1.78x0.72
238	310192	Wheel 7x4x2.44x0.838
239	310191	Wheel 6x3x2.44x0.838
246	310210	Wheel 3.25x5.5x1.98x0.69
248	310084	Wheel 3.25x6x1.98x0.912
254	310195	Wheel 5x2.87x1.78x0.80
255	310195	Wheel 5x2.87x1.78x0.80
257	310183	Wheel 4x2.75x2.44x0.843
262	310171	Wheel 6x3x1.781x0.81
268	310196	Wheel 6x3x1.938x0.969
275	310195	Wheel 5x2.87x1.78x0.80
305	310191	Wheel 6x3x2.44x0.838
308	310133	Wheel 5x2.88x2.44x0.775
308	310143	Wheel 5x2.88x2.44x0.75
315	310192	Wheel 7x4x2.44x0.838
336	310171	Wheel 6x3x1.781x0.81
9806	310149	Wheel 3.25x3x2.047x0.656
9811	077086	Wheel 3.25x5x2.047x0.59
9842	310181	Wheel 4x2.88x2.44x0.832
9844	310235	Wheel 4x2.88x2.44x0.672
9852	310133	Wheel 5x2.88x2.44x0.775
9852	310143	Wheel 5x2.88x2.44x0.75
9870	310155	Wheel 7x2.5x2.326xNon Typical
116810	310071	Tire Poly 18x8x12.125
116813	310064	Tire Poly 16.25x5x11.25
116814	310068	Tire Poly 18x6x12.125
116815	310060	Tire Poly 16x5x10.5
127220	310061	Tire Poly 16x6x10.5
127222	310073	Tire Poly 21x7x15
137868	310003	Tire Poly 8x4.5x4.5
139191	310202	Tire Poly 10x5x6.5 w/Bevel
704662	310003	Tire Poly 8x4.5x4.5
705357	310003	Tire Poly 8x4.5x4.5
708394	310024	Tire Poly 10.5x7x6.5
708396	310022	Tire Poly 10.5x6x6.5
708397	075715	Tire Poly 10x4x6.5
710330	310019	Tire Poly 10.5x5x5
991012	107933	Tire Poly 10x5x6.5 Contour
10761-058	310192	Wheel 7x4x2.44x0.838
10761-29	310171	Wheel 6x3x1.781x0.81
27462-008	310195	Wheel 5x2.87x1.78x0.80
27462-025	310171	Wheel 6x3x1.781x0.81
27845-11	310196	Wheel 6x3x1.938x0.969

OE Number	Crown Base Part No.	Description
27845-21	310195	Wheel 5x2.87x1.78x0.80
27845-40	310195	Wheel 5x2.87x1.78x0.80
28-12	310191	Wheel 6x3x2.44x0.838
28-152	310191	Wheel 6x3x2.44x0.838
28-156	310192	Wheel 7x4x2.44x0.838
28700-064	077086	Wheel 3.25x5x2.047x0.59
28841-088	310181	Wheel 4x2.88x2.44x0.832
28842-676	107933	Tire Poly 10x5x6.5 Contour
28842-942	310155	Wheel 7x2.5x2.326xNon Typical
304A	310196	Wheel 6x3x1.938x0.969
39102-005	310171	Wheel 6x3x1.781x0.81
39102-007	310171	Wheel 6x3x1.781x0.81
40310-FS000	310178	Wheel 3.25x5.91x2.047x1.18
40310-FS001	310147	Wheel 3.25x6x2.047x1.187
40310-FS001	310242	Wheel 3.25x5.98x2.047x1.368
40350-FS002	310242	Wheel 3.25x5.98x2.047x1.368
43382-FS000	310126	Wheel 5x2.5x1.85x0.675
9988-005	310193	Wheel 4x2.75x1.78x0.72
9988-038	310144	Wheel 3.25x6x2.047x0.812
9988-04	310084	Wheel 3.25x6x1.98x0.912
9988-048	310084	Wheel 3.25x6x1.98x0.912
9988-055	310144	Wheel 3.25x6x2.047x0.812
9988-057	310210	Wheel 3.25x5.5x1.98x0.69
9988-063	310194	Wheel 3.25x2.88x1.98xNon Typical
9988-064	310235	Wheel 4x2.88x2.44x0.672
9988-065	310144	Wheel 3.25x6x2.047x0.812
9988-066	310084	Wheel 3.25x6x1.98x0.912
9988-068	310133	Wheel 5x2.88x2.44x0.775
9988-068	310143	Wheel 5x2.88x2.44x0.75
9988-57	310210	Wheel 3.25x5.5x1.98x0.69
9988-60	310183	Wheel 4x2.75x2.44x0.843
9988-63	310149	Wheel 3.25x3x2.047x0.656
A10761-002	310191	Wheel 6x3x2.44x0.838
A10761-006	310192	Wheel 7x4x2.44x0.838
A-10761-006	310192	Wheel 7x4x2.44x0.838
A10761-2	310191	Wheel 6x3x2.44x0.838
A-10761-2	310191	Wheel 6x3x2.44x0.838
A10761-49	310171	Wheel 6x3x1.781x0.81
A-10761-49	310171	Wheel 6x3x1.781x0.81
A10761-6	310192	Wheel 7x4x2.44x0.838
A-10761-6	310192	Wheel 7x4x2.44x0.838
A11151-2	310196	Wheel 6x3x1.938x0.969
A13076-008	107933	Tire Poly 10x5x6.5 Contour
A27462-008	310195	Wheel 5x2.87x1.78x0.80
A-27462-008	310195	Wheel 5x2.87x1.78x0.80
A27845-2	310196	Wheel 6x3x1.938x0.969
A27845-40	310229	Wheel 5x3x3.25x1.78
A30629-001	310202	Tire Poly 10x5x6.5 w/Bevel
A9988-005	310193	Wheel 4x2.75x1.78x0.72
A-9988-005	310193	Wheel 4x2.75x1.78x0.72
A-9988-048	310084	Wheel 3.25x6x1.98x0.912
A9988-057	310210	Wheel 3.25x5.5x1.98x0.69
A9988-30	310195	Wheel 5x2.87x1.78x0.80
A-9988-30	310229	Wheel 5x3x3.25x1.78
A9988-38	310144	Wheel 3.25x6x2.047x0.812
A-9988-38	310144	Wheel 3.25x6x2.047x0.812
A9988-48	310084	Wheel 3.25x6x1.98x0.912
A9988-5	310193	Wheel 4x2.75x1.78x0.72
A9988-54	310194	Wheel 3.25x2.88x1.98xNon Typical
A-9988-54	310194	Wheel 3.25x2.88x1.98xNon Typical
A-9988-57	310210	Wheel 3.25x5.5x1.98x0.69
AT-10761-29	310171	Wheel 6x3x1.781x0.81
AT-11151-2	310196	Wheel 6x3x1.938x0.969
AT-28-10	310196	Wheel 6x3x1.938x0.969
AT-28-12	310191	Wheel 6x3x2.44x0.838
AT-28-140	310196	Wheel 6x3x1.938x0.969
AT-28-152	310191	Wheel 6x3x2.44x0.838
B9988-54	310194	Wheel 3.25x2.88x1.98xNon Typical
PM40265-00	107933	Tire Poly 10x5x6.5 Contour

Note: Add the compound part number to the base number listed above. Wheel compounds listed on page 11.03 (Format: XXXXX-XXX.) and tire compounds and treads listed on page 11.19 (Format: XXXXX-XXX-XX).

Barrett Continued ▶

Wheel & Tire Cross References

Continued ▶

Barrett Continued

OE Number	Crown Base Part No.	Description
S227	310149	Wheel 3.25x3x2.047x0.656
S228	310194	Wheel 3.25x2.88x1.98xNon Typical
S230	310144	Wheel 3.25x6x2.047x0.812
S234	310193	Wheel 4x2.75x1.78x0.72
S238	310192	Wheel 7x4x2.44x0.838
S239	310191	Wheel 6x3x2.44x0.838
S241	310196	Wheel 6x3x1.938x0.969
S246	310210	Wheel 3.25x5.5x1.98x0.69
S248	310084	Wheel 3.25x6x1.98x0.912
S250	310210	Wheel 3.25x5.5x1.98x0.69
S254	310195	Wheel 5x2.87x1.78x0.80
S255	310183	Wheel 4x2.75x2.44x0.843
S256	310084	Wheel 3.25x6x1.98x0.912
S258	310195	Wheel 5x2.87x1.78x0.80
S262	310171	Wheel 6x3x1.781x0.81
S263	310133	Wheel 5x2.88x2.44x0.775
S263	310143	Wheel 5x2.88x2.44x0.75
S268	310196	Wheel 6x3x1.938x0.969
S275	310195	Wheel 5x2.87x1.78x0.80
S282	310155	Wheel 7x2.5x2.326xNon Typical
S284	310192	Wheel 7x4x2.44x0.838
S294	310181	Wheel 4x2.88x2.44x0.832
S295	310133	Wheel 5x2.88x2.44x0.775
S295	310143	Wheel 5x2.88x2.44x0.75
S304A	310196	Wheel 6x3x1.938x0.969
T0018-512PV	310067	Tire Poly 18x5x12.125
T0021-715SPU	310073	Tire Poly 21x7x15
T0186-12PUS	310068	Tire Poly 18x6x12.125
T0228-16TPU	310075	Tire Poly 22x8x16
T8-192	310191	Wheel 6x3x2.44x0.838
T-8-192	310191	Wheel 6x3x2.44x0.838
T8-197	310192	Wheel 7x4x2.44x0.838
T-8-28	310196	Wheel 6x3x1.938x0.969
Big Joe (BJ)		
106	310184	Wheel 3.38x2.75x2.047x0.605
107	310244	Wheel 3.25x4.5x2.047x.594
108	077084	Wheel 3.25x3.25x2.047x0.59
119	310101	Wheel 3.38x2.63x1.979x1.242
202	310098	Wheel 4x2.75x1.938xThru
312	310132	Wheel 6x3x2.047x0.595
338	310101	Wheel 3.38x2.63x1.979x1.242
467	310132	Wheel 6x3x2.047x0.595
2335	310244	Wheel 3.25x4.5x2.047x.594
2352	310098	Wheel 4x2.75x1.938xThru
2353	310099	Wheel 4x2.75x2.047x0.59
2360	310184	Wheel 3.38x2.75x2.047x0.605
9133	077084	Wheel 3.25x3.25x2.047x0.59
9145	081645	Wheel Poly
78217	310184	Wheel 3.38x2.75x2.047x0.605
78228	310184	Wheel 3.38x2.75x2.047x0.605
78242	310080	Wheel 3x2x2.047x0.625
78255	077084	Wheel 3.25x3.25x2.047x0.59
78257	310244	Wheel 3.25x4.5x2.047x.594
78262	100462	Wheel 3.25x6.5x2.047x1.44
78262	310000	Wheel 3.25x6.5 Single Bearing
78264	310101	Wheel 3.38x2.63x1.979x1.242
78288	310184	Wheel 3.38x2.75x2.047x0.605
78414	310099	Wheel 4x2.75x2.047x0.59
78433	310099	Wheel 4x2.75x2.047x0.59
79114	310020	Tire Poly 10.5x5x6.5
79161	075715	Tire Poly 10x4x6.5
79162	075715	Tire Poly 10x4x6.5
79163	310020	Tire Poly 10.5x5x6.5
79266	079266	Tire Poly 13x5.5x8
79494	079494	Tire Poly 13x4.5x8
501324	310132	Wheel 6x3x2.047x0.595
501433	077084	Wheel 3.25x3.25x2.047x0.59
501692	310244	Wheel 3.25x4.5x2.047x.594
504146	310101	Wheel 3.38x2.63x1.979x1.242

OE Number	Crown Base Part No.	Description
800032	081645	Wheel Poly
800059	310132	Wheel 6x3x2.047x0.595
908000	310020	Tire Poly 10.5x5x6.5
911144	310020	Tire Poly 10.5x5x6.5
941182	310208	Tire Poly 9x5x5 Smooth Step
S2352	310098	Wheel 4x2.75x1.938xThru
S2353	310099	Wheel 4x2.75x2.047x0.59
S2356	077084	Wheel 3.25x3.25x2.047x0.59
S2358	310132	Wheel 6x3x2.047x0.595
S2361	081645	Wheel Poly
S2364	100462	Wheel 3.25x6.5x2.047x1.44
S2364	310000	Wheel 3.25x6.5 Single Bearing
S2365	310244	Wheel 3.25x4.5x2.047x.594
S2373	310184	Wheel 3.38x2.75x2.047x0.605
S2376	310101	Wheel 3.38x2.63x1.979x1.242
S338	310101	Wheel 3.38x2.63x1.979x1.242
Blue Giant (BG)		
101	310083	Wheel 3x3.75x1.625x0.435
103	310085	Wheel 3.25x6x2.047x0.585
301	310090	Wheel 8x2x2.047x0.595
930	310083	Wheel 3x3.75x1.625x0.435
931	310090	Wheel 8x2x2.047x0.595
9810	310085	Wheel 3.25x6x2.047x0.585
107193	310097	Wheel 8x2x1.998xThru
007-106-1	310083	Wheel 3x3.75x1.625x0.435
007-125-1	310090	Wheel 8x2x2.047x0.595
020-031	310090	Wheel 8x2x2.047x0.595
020-056-99	310083	Wheel 3x3.75x1.625x0.435
102-U	310090	Wheel 8x2x2.047x0.595
103-291	310083	Wheel 3x3.75x1.625x0.435
103-297	310083	Wheel 3x3.75x1.625x0.435
108-943	310085	Wheel 3.25x6x2.047x0.585
108-973-99	310085	Wheel 3.25x6x2.047x0.585
110-930	310083	Wheel 3x3.75x1.625x0.435
114-514	310083	Wheel 3x3.75x1.625x0.435
200-061	310083	Wheel 3x3.75x1.625x0.435
300-000	310083	Wheel 3x3.75x1.625x0.435
300-028	310083	Wheel 3x3.75x1.625x0.435
BLR3-2120	310083	Wheel 3x3.75x1.625x0.435
LR-783	310090	Wheel 8x2x2.047x0.595
S925	310090	Wheel 8x2x2.047x0.595
S930	310083	Wheel 3x3.75x1.625x0.435
S931	310090	Wheel 8x2x2.047x0.595
S935	310085	Wheel 3.25x6x2.047x0.585
BT (BT)		
23041-00	077086	Wheel 3.25x5x2.047x0.59
312636-001	310316	Wheel 3.25x4.48x2.047x0.582
40265-00	107933	Tire Poly 10x5x6.5 Contour
46106	310288	Wheel 5.5x2.38x2.047x0.590
Caterpillar/ Towmotor (CT)		
101	310162	Wheel 3.38x2.25x1.85x0.551
115	310178	Wheel 3.25x5.91x2.047x1.18
202	310164	Wheel 5x2.88x2.047x0.59
206	310160	Wheel 5x3.63x2.44x0.668
314	310161	Wheel 6x2.5x2.327x1.967
325	310172	Wheel 6x3.63x2.44x0.668
327	310179	Wheel 8x4x2.44x0.656
629	154840	Wheel 3.25x2x2.047x0.59
630	310162	Wheel 3.38x2.25x1.85x0.551
632	310176	Wheel 4x2x2.44xNon Typical
636	310078	Wheel 3.25x2.88x2.047x0.59
641	073961	Wheel 4x2.88x2.047x0.59
644	310221	Wheel 4x1.92x1.781x.84
645	310158	Wheel 4x3.62x2.047x0.59
653	310164	Wheel 5x2.88x2.047x0.59
654	310160	Wheel 5x3.63x2.44x0.668
663	310161	Wheel 6x2.5x2.327x1.967
673	310172	Wheel 6x3.63x2.44x0.668
684	310179	Wheel 8x4x2.44x0.656

WHEELS AND TIRES

Note: Add the compound part number to the base number listed above. Wheel compounds listed on page 11.03 (Format: XXXXX-XXX.) and tire compounds and treads listed on page 11.19 (Format: XXXXX-XXX-XX).

Caterpillar/Towmotor Continued ▶

Caterpillar/Towmotor Continued

OE Number	Crown Base Part No.	Description
699	310177	Wheel 6x3x2.047x0.67
700	310178	Wheel 3.25x5.91x2.047x1.18
7711	310180	Wheel 3.25x4.2x2.047x1.18
9143	083179	Wheel 4x2.50x2.047x0.59
9811	077086	Wheel 3.25x5x2.047x0.59
12710	073961	Wheel 4x2.88x2.047x0.59
12711	310158	Wheel 4x3.62x2.047x0.59
12713	310164	Wheel 5x2.88x2.047x0.59
12714	310160	Wheel 5x3.63x2.44x0.668
12726	310179	Wheel 8x4x2.44x0.656
12754	310172	Wheel 6x3.63x2.44x0.668
17102	310221	Wheel 4x1.92x1.781x.84
50432647	310467	Caster Wheel Assembly
63009	310172	Wheel 6x3.63x2.44x0.668
67018	083179	Wheel 4x2.50x2.047x0.59
120737	120737	Wheel Steer
289069	310178	Wheel 3.25x5.91x2.047x1.18
971756	073961	Wheel 4x2.88x2.047x0.59
971757	310160	Wheel 5x3.63x2.44x0.668
971758	310161	Wheel 6x2.5x2.327x1.967
971761	083179	Wheel 4x2.50x2.047x0.59
971763	082021	Wheel 6x2.75x3.149x0.83
971764	083587	Wheel 5x4.12x3.149x0.98
971768	083586	Wheel 5x2.88x3.149x0.98
971875	077086	Wheel 3.25x5x2.047x0.59
971880	077086	Wheel 3.25x5x2.047x0.59
971943	073961	Wheel 4x2.88x2.047x0.59
971994	082443	Wheel 2.50x2.06x1.187
971995	072718	Wheel Assm Poly
971997	075999	Wheel
971999	083879	Roller Load
972001	071665	Wheel Polyurethane
972005	083879	Roller Load
972007	100462	Wheel 3.25x6.5x2.047x1.44
972008	077086	Wheel 3.25x5x2.047x0.59
972010	083585	Wheel 4x2.88x2.047x0.75
972012	081645	Wheel Poly
972015	073961	Wheel 4x2.88x2.047x0.59
972016	081645	Wheel Poly
972019	071892	Wheel 5 dia
972020	073602	Wheel 5 Steel Assm
972021	083586	Wheel 5x2.88x3.149x0.98
972025	082020	Wheel 6x4.25x3.149x0.83
972027	080915	Wheel 8x3.75x3.15x0.83
972061	083879	Roller Load
973588	100462	Wheel 3.25x6.5x2.047x1.44
1009233	310177	Wheel 6x3x2.047x0.67
1009234	310178	Wheel 3.25x5.91x2.047x1.18
1009298	310221	Wheel 4x1.92x1.781x.84
1009309	310221	Wheel 4x1.92x1.781x.84
1029601	310177	Wheel 6x3x2.047x0.67
1029602	310178	Wheel 3.25x5.91x2.047x1.18
1029606	310177	Wheel 6x3x2.047x0.67
1029607	310178	Wheel 3.25x5.91x2.047x1.18
1029608	310177	Wheel 6x3x2.047x0.67
1036603	310172	Wheel 6x3.63x2.44x0.668
1049809	073961	Wheel 4x2.88x2.047x0.59
1049911	310158	Wheel 4x3.62x2.047x0.59
1050132	310164	Wheel 5x2.88x2.047x0.59
1050137	310160	Wheel 5x3.63x2.44x0.668
1050142	310179	Wheel 8x4x2.44x0.656
1050234	310179	Wheel 8x4x2.44x0.656
1050236	310179	Wheel 8x4x2.44x0.656
1050237	310160	Wheel 5x3.63x2.44x0.668
1050280	310018	Tire Poly 10.5x4.5x8
1051264	310179	Wheel 8x4x2.44x0.656
1055548	310160	Wheel 5x3.63x2.44x0.668
1055550	310158	Wheel 4x3.62x2.047x0.59
1055551	073961	Wheel 4x2.88x2.047x0.59

OE Number	Crown Base Part No.	Description
1055553	310164	Wheel 5x2.88x2.047x0.59
1055574	310018	Tire Poly 10.5x4.5x8
1075061	077086	Wheel 3.25x5x2.047x0.59
1075062	077086	Wheel 3.25x5x2.047x0.59
1075063	077086	Wheel 3.25x5x2.047x0.59
1075064	077086	Wheel 3.25x5x2.047x0.59
1086863	310180	Wheel 3.25x4.2x2.047x1.18
1086864	310180	Wheel 3.25x4.2x2.047x1.18
1086865	310180	Wheel 3.25x4.2x2.047x1.18
1086866	310180	Wheel 3.25x4.2x2.047x1.18
1092509	310176	Wheel 4x2x2.44xNon Typical
1149188	310162	Wheel 3.38x2.25x1.85x0.551
1154009	154840	Wheel 3.25x2x2.047x0.59
1154011	154840	Wheel 3.25x2x2.047x0.59
1154013	154840	Wheel 3.25x2x2.047x0.59
1179201	310078	Wheel 3.25x2.88x2.047x0.59
1179210	073961	Wheel 4x2.88x2.047x0.59
1179213	310164	Wheel 5x2.88x2.047x0.59
1201281	310078	Wheel 3.25x2.88x2.047x0.59
1201764	154840	Wheel 3.25x2x2.047x0.59
1201766	073961	Wheel 4x2.88x2.047x0.59
1201767	310158	Wheel 4x3.62x2.047x0.59
1201768	310158	Wheel 4x3.62x2.047x0.59
1201769	310164	Wheel 5x2.88x2.047x0.59
1201770	310160	Wheel 5x3.63x2.44x0.668
1201771	310160	Wheel 5x3.63x2.44x0.668
1201774	310078	Wheel 3.25x2.88x2.047x0.59
1201776	310179	Wheel 8x4x2.44x0.656
1201777	310179	Wheel 8x4x2.44x0.656
1201778	310172	Wheel 6x3.63x2.44x0.668
1201779	310172	Wheel 6x3.63x2.44x0.668
1201785	310018	Tire Poly 10.5x4.5x8
10289069	310178	Wheel 3.25x5.91x2.047x1.18
50136157	370231	Load Wheel Assembly
50179921	370231	Load Wheel Assembly
51061889	310310	Tire Poly 13.5x4.5x10.25
71305290	370231	Load Wheel Assembly
00590-00027	310178	Wheel 3.25x5.91x2.047x1.18
00590-41747	310225	Wheel 6x3x1.9687
116P	310078	Wheel 3.25x2.88x2.047x0.59
212824	077086	Wheel 3.25x5x2.047x0.59
215852	310131	Wheel 8.5x2.66x2.754xNon Typical
215854	310131	Wheel 8.5x2.66x2.754xNon Typical
215938	041269	Wheel Poly
310225-035	310225	Wheel 6x3x1.9687
312636-000	310316	Wheel 3.25x4.48x2.047x0.582
325-P	310174	Wheel 3.25x4x1.85x0.551
590-00013-71	310180	Wheel 3.25x4.2x2.047x1.18
590-00506-71	310078	Wheel 3.25x2.88x2.047x0.59
632-041	310168	Wheel 5x1.12x2.047xNon Typical
CTNA067018	083179	Wheel 4x2.50x2.047x0.59
CTS654X	310160	Wheel 5x3.63x2.44x0.668
S132	310180	Wheel 3.25x4.2x2.047x1.18
S2400	310178	Wheel 3.25x5.91x2.047x1.18
S2401	310162	Wheel 3.38x2.25x1.85x0.551
S2402	310164	Wheel 5x2.88x2.047x0.59
S2403	310160	Wheel 5x3.63x2.44x0.668
S2404	310161	Wheel 6x2.5x2.327x1.967
S626	310078	Wheel 3.25x2.88x2.047x0.59
S627	154840	Wheel 3.25x2x2.047x0.59
S629	310178	Wheel 3.25x5.91x2.047x1.18
S632	310176	Wheel 4x2x2.44xNon Typical
S636	077086	Wheel 3.25x5x2.047x0.59
S640	310221	Wheel 4x1.92x1.781x.84
S645	310158	Wheel 4x3.62x2.047x0.59
S653	310164	Wheel 5x2.88x2.047x0.59
S654	310160	Wheel 5x3.63x2.44x0.668
S654X	310160	Wheel 5x3.63x2.44x0.668
S673	310172	Wheel 6x3.63x2.44x0.668

Note: Add the compound part number to the base number listed above. Wheel compounds listed on page 11.03 (Format: XXXXX-XXX.) and tire compounds and treads listed on page 11.19 (Format: XXXXX-XXX-XX).

Caterpillar/Towmotor Continued ▶

Wheel & Tire Cross References

Continued ▶

Caterpillar/Towmotor Continued

OE Number	Crown Base Part No.	Description
S674	310172	Wheel 6x3.63x2.44x0.668
S675	310177	Wheel 6x3x2.047x0.67
S684	310179	Wheel 8x4x2.44x0.656
S700	310178	Wheel 3.25x5.91x2.047x1.18
S9811	077086	Wheel 3.25x5x2.047x0.59
S9812	077086	Wheel 3.25x5x2.047x0.59
S9813	077086	Wheel 3.25x5x2.047x0.59
S9814	077086	Wheel 3.25x5x2.047x0.59
S984	310078	Wheel 3.25x2.88x2.047x0.59
A0000-23185	310245	Wheel 3.25x4.5x2.047x.710
A0000-35291	310245	Wheel 3.25x4.5x2.047x.710
W2050-11106	370231	Load Wheel Assembly
W2050-12975	100462	Wheel 3.25x6.5x2.047x1.44
W2050-12884	310467	Caster Wheel Assembly
W5050-10126	310310	Tire Poly 13.5x4.5x10.25
Clark (CL)		
105	077086	Wheel 3.25x5x2.047x0.59
109	310100	Wheel 3.38x2.63x1.967x0.935
119	310101	Wheel 3.38x2.63x1.979x1.242
123	310110	Wheel 3.38x2.63x2.047x0.67
125	310110	Wheel 3.38x2.63x2.047x0.67
130	310112	Wheel 3.38x2.63x2.047x1.137
136	310118	Wheel 3.25x2.63x2.046x1.1373
201	071894	Wheel 4 Poly
202	310103	Wheel 4x2.63x2.44x0.77
203	310105	Wheel 4x2.5x1.938x0.96
204	310114	Wheel 4x2.5x2.047x0.76
211	310186	Wheel 4x2.37x1.938x0.96
300	310113	Wheel 3.35x5.74x2.047x1.452
301	310118	Wheel 3.25x2.63x2.046x1.1373
303	310112	Wheel 3.38x2.63x2.047x1.137
304	310114	Wheel 4x2.5x2.047x0.76
306	310154	Wheel 6x3.94x2.872x1.224
308	310109	Wheel 6x4x2.834x1.17
309	310112	Wheel 3.38x2.63x2.047x1.137
321	310104	Wheel 5x2.62x2.834x0.77
325	310107	Wheel 7x2.5x2.328xNon Typical
326	310106	Wheel 4x3.62x2.44x0.77
332	310116	Wheel 5x3.75x2.834x0.74
335	310100	Wheel 3.38x2.63x1.967x0.935
338	310101	Wheel 3.38x2.63x1.979x1.242
339	310110	Wheel 3.38x2.63x2.047x0.67
341	310103	Wheel 4x2.63x2.44x0.77
342	310105	Wheel 4x2.5x1.938x0.96
343	310106	Wheel 4x3.62x2.44x0.77
351	310104	Wheel 5x2.62x2.834x0.77
353	310102	Wheel 5x3.62x2.834x0.76
354	310116	Wheel 5x3.75x2.834x0.74
362	310109	Wheel 6x4x2.834x1.17
372	310107	Wheel 7x2.5x2.328xNon Typical
395	310117	Wheel 9x5x3.542x0.787 Black
502	310108	Wheel 4x1.88x2.44x0.76
653	310164	Wheel 5x2.88x2.047x0.59
824	310186	Wheel 4x2.37x1.938x0.96
9102	071894	Wheel 4 Poly
9111	082021	Wheel 6x2.75x3.149x0.83
9119	310131	Wheel 8.5x2.66x2.754xNon Typical
9136	100462	Wheel 3.25x6.5x2.047x1.44
9139	083970	Wheel 3.25x4.50x2.44x0.66
9151	083587	Wheel 5x4.12x3.149x0.98
9152	083586	Wheel 5x2.88x3.149x0.98
9330	310188	Wheel 3.25x3.75x1.75xThru
9811	077086	Wheel 3.25x5x2.047x0.59
9842	310181	Wheel 4x2.88x2.44x0.832
9862	310154	Wheel 6x3.94x2.872x1.224
182145	077086	Wheel 3.25x5x2.047x0.59
301473	310109	Wheel 6x4x2.834x1.17
310806	310109	Wheel 6x4x2.834x1.17
311679	310109	Wheel 6x4x2.834x1.17

OE Number	Crown Base Part No.	Description
314713	310100	Wheel 3.38x2.63x1.967x0.935
315538	310100	Wheel 3.38x2.63x1.967x0.935
315540	310100	Wheel 3.38x2.63x1.967x0.935
326915	310100	Wheel 3.38x2.63x1.967x0.935
326917	310100	Wheel 3.38x2.63x1.967x0.935
327229	310109	Wheel 6x4x2.834x1.17
399153	310103	Wheel 4x2.63x2.44x0.77
885906	310061	Tire Poly 16x6x10.5
886191	310071	Tire Poly 18x8x12.125
886192	310067	Tire Poly 18x5x12.125
886310	107933	Tire Poly 10x5x6.5 Contour
886342	310100	Wheel 3.38x2.63x1.967x0.935
887050	077086	Wheel 3.25x5x2.047x0.59
898577	310105	Wheel 4x2.5x1.938x0.96
908684	310154	Wheel 6x3.94x2.872x1.224
910970	310186	Wheel 4x2.37x1.938x0.96
915157	083179	Wheel 4x2.50x2.047x0.59
996691	310107	Wheel 7x2.5x2.328xNon Typical
1612413	310104	Wheel 5x2.62x2.834x0.77
1747963	310108	Wheel 4x1.88x2.44x0.76
1780716	310101	Wheel 3.38x2.63x1.979x1.242
1784625	310222	Wheel 6x3.88x2.834x.735
1800127	310109	Wheel 6x4x2.834x1.17
1800338	310103	Wheel 4x2.63x2.44x0.77
1800344	073961	Wheel 4x2.88x2.047x0.59
1800435	310104	Wheel 5x2.62x2.834x0.77
1802523	310106	Wheel 4x3.62x2.44x0.77
1802848	310039	Tire Poly 13.5x5.5x8
1803654	083587	Wheel 5x4.12x3.149x0.98
1803655	083586	Wheel 5x2.88x3.149x0.98
1803656	082021	Wheel 6x2.75x3.149x0.83
1803657	132359	Wheel Caster
1803657	310131	Wheel 8.5x2.66x2.754xNon Typical
1803659	100462	Wheel 3.25x6.5x2.047x1.44
1803792	310164	Wheel 5x2.88x2.047x0.59
1803794	083970	Wheel 3.25x4.50x2.44x0.66
1803829	100462	Wheel 3.25x6.5x2.047x1.44
1819046	310181	Wheel 4x2.88x2.44x0.832
1820704	310003	Tire Poly 8x4.5x4.5
1821946	077086	Wheel 3.25x5x2.047x0.59
2309088	310116	Wheel 5x3.75x2.834x0.74
2309954	107933	Tire Poly 10x5x6.5 Contour
2324039	105089	Tire Poly 10.5x4.5x8
2324040	310017	Tire Poly 10.5x3.5x8
2324041	105089	Tire Poly 10.5x4.5x8
2324106	310102	Wheel 5x3.62x2.834x0.76
2326083	310072	Tire Poly 18x9x12.125
2326659	310068	Tire Poly 18x6x12.125
2334092	079266	Tire Poly 13x5.5x8
2338041	310060	Tire Poly 16x5x10.5
2381813	310101	Wheel 3.38x2.63x1.979x1.242
2389996	310110	Wheel 3.38x2.63x2.047x0.67
2742092	310110	Wheel 3.38x2.63x2.047x0.67
2742092	310111	Wheel 3.35x2.63x2.047x0.76
2750167	310144	Wheel 3.25x6x2.047x0.812
2751505	310106	Wheel 4x3.62x2.44x0.77
2758129	107933	Tire Poly 10x5x6.5 Contour
2760613	310101	Wheel 3.38x2.63x1.979x1.242
2775267	310117	Wheel 9x5x3.542x0.787 Black
2777378	310114	Wheel 4x2.5x2.047x0.76
2777940	310112	Wheel 3.38x2.63x2.047x1.137
2778678	310113	Wheel 3.35x5.74x2.047x1.452
2778705	107933	Tire Poly 10x5x6.5 Contour
2779408	310112	Wheel 3.38x2.63x2.047x1.137
2780830	310113	Wheel 3.35x5.74x2.047x1.452
2788079	310116	Wheel 5x3.75x2.834x0.74
2788081	310115	Wheel 5x3x2.834x0.74
2792213	310117	Wheel 9x5x3.542x0.787 Black
2793182	310117	Wheel 9x5x3.542x0.787 Black

WHEELS AND TIRES

Note: Add the compound part number to the base number listed above. Wheel compounds listed on page 11.03 (Format: XXXXXX-XXX) and tire compounds and treads listed on page 11.19 (Format: XXXXXX-XXX-XX).

Clark Continued ▶

Clark Continued

OE Number	Crown Base Part No.	Description
2793509	310039	Tire Poly 13.5x5.5x8
2794001	310208	Tire Poly 9x5x5 Smooth Step
2794307	079266	Tire Poly 13x5.5x8
2795684	310116	Wheel 5x3.75x2.834x0.74
2795685	310115	Wheel 5x3x2.834x0.74
2800769	310138	Wheel 3.25x4.71x2.047x0.825
2800770	310118	Wheel 3.25x2.63x2.046x1.1373
7003071	082274	Wheel Assm
7003097	044495	Wheel Assm Poly
7003580	082443	Wheel 2.50x2.06x1.187
7003582	081645	Wheel Poly
106A	310144	Wheel 3.25x6x2.047x0.812
B26460	310154	Wheel 6x3.94x2.872x1.224
L000318	310118	Wheel 3.25x2.63x2.046x1.1373
L000319	310112	Wheel 3.38x2.63x2.047x1.137
L000322	310112	Wheel 3.38x2.63x2.047x1.137
L000328	310112	Wheel 3.38x2.63x2.047x1.137
L000333	310110	Wheel 3.38x2.63x2.047x0.67
L000335	310100	Wheel 3.38x2.63x1.967x0.935
L000338	310101	Wheel 3.38x2.63x1.979x1.242
L000339	310111	Wheel 3.35x2.63x2.047x0.76
L000341	310103	Wheel 4x2.63x2.44x0.77
L000342	310105	Wheel 4x2.5x1.938x0.96
L000343	310106	Wheel 4x3.62x2.44x0.77
L000344	310181	Wheel 4x2.88x2.44x0.832
L000345	077086	Wheel 3.25x5x2.047x0.59
L000346	310114	Wheel 4x2.5x2.047x0.76
L000351	310104	Wheel 5x2.62x2.834x0.77
L000353	310102	Wheel 5x3.62x2.834x0.76
L000359	310113	Wheel 3.35x5.74x2.047x1.452
L000362	310109	Wheel 6x4x2.834x1.17
L000366	310154	Wheel 6x3.94x2.872x1.224
L000372	310107	Wheel 7x2.5x2.328xNon Typical
L000376	310115	Wheel 5x3x2.834x0.74
L000377	310116	Wheel 5x3.75x2.834x0.74
L000393	310117	Wheel 9x5x3.542x0.787 Black
L000399	310112	Wheel 3.38x2.63x2.047x1.137
L000529	310144	Wheel 3.25x6x2.047x0.812
L000581	310179	Wheel 8x4x2.44x0.656
L000641	073961	Wheel 4x2.88x2.047x0.59
L000684	310179	Wheel 8x4x2.44x0.656
L000850	310093	Wheel 3.25x6.5x1.98x1.177
L002361	081645	Wheel Poly
L009101	072718	Wheel Assm Poly
L009103	073602	Wheel 5 Steel Assm
L009105	071892	Wheel 5 dia
L009107	071665	Wheel Polyurethane
L009110	075999	Wheel
L009111	082021	Wheel 6x2.75x3.149x0.83
L009112	082443	Wheel 2.50x2.06x1.187
L009113	083834	Wheel
L009116	080915	Wheel 8x3.75x3.15x0.83
L009117	082020	Wheel 6x4.25x3.149x0.83
L009119	310131	Wheel 8.5x2.66x2.754xNon Typical
L009130	311520	Wheel 10x3 Caster
L009132	083879	Roller Load
L009135	077086	Wheel 3.25x5x2.047x0.59
L009136	100462	Wheel 3.25x6.5x2.047x1.44
L009138	083879	Roller Load
L009138S	083879	Roller Load
L009140	071665	Wheel Polyurethane
L009142	081645	Wheel Poly
L009143	083179	Wheel 4x2.50x2.047x0.59
L009145	081645	Wheel Poly
L009146	083585	Wheel 4x2.88x2.047x0.75
L009149	088628	Wheel 4x4.12x2.047x0.75
L009150	115032	Wheel 5x2.88x2.44x0.83
L009151	083587	Wheel 5x4.12x3.149x0.98
L009152	083586	Wheel 5x2.88x3.149x0.98

OE Number	Crown Base Part No.	Description
L009153	115033	Wheel 5x4.12x2.44x0.83
L009154	310131	Wheel 8.5x2.66x2.754xNon Typical
L009157	115033	Wheel 5x4.12x2.44x0.83
L009532	083879	Roller Load
L010210	044507	Roller Poly
L300628	310251	Wheel 3.25x5.937x2.047x0.591
L300982	081645	Wheel Poly
L309105	071892	Wheel 5 dia
L309107	071665	Wheel Polyurethane
L309111	082021	Wheel 6x2.75x3.149x0.83
L309116	080915	Wheel 8x3.75x3.15x0.83
L309117	082020	Wheel 6x4.25x3.149x0.83
L309130	311520	Wheel 10x3 Caster
L309140	071665	Wheel Polyurethane
L309146	083585	Wheel 4x2.88x2.047x0.75
L309149	088628	Wheel 4x4.12x2.047x0.75
L309153	115033	Wheel 5x4.12x2.44x0.83
L309154	310131	Wheel 8.5x2.66x2.754xNon Typical
L309157	115033	Wheel 5x4.12x2.44x0.83
L502361	081645	Wheel Poly
L509101	072718	Wheel Assm Poly
L509109	083586	Wheel 5x2.88x3.149x0.98
L509110	075999	Wheel
L509142	081645	Wheel Poly
L509146	083585	Wheel 4x2.88x2.047x0.75
L509149	088628	Wheel 4x4.12x2.047x0.75
L509150	115032	Wheel 5x2.88x2.44x0.83
L509152	083586	Wheel 5x2.88x3.149x0.98
L509817	083179	Wheel 4x2.50x2.047x0.59
L510210	044507	Roller Poly
R0101	310188	Wheel 3.25x3.75x1.75xThru
S303	310112	Wheel 3.38x2.63x2.047x1.137
S312	310188	Wheel 3.25x3.75x1.75xThru
S317	310186	Wheel 4x2.37x1.938x0.96
S318	310118	Wheel 3.25x2.63x2.046x1.1373
S319	310118	Wheel 3.25x2.63x2.046x1.1373
S322	310112	Wheel 3.38x2.63x2.047x1.137
S328	310112	Wheel 3.38x2.63x2.047x1.137
S333	310110	Wheel 3.38x2.63x2.047x0.67
S335	310100	Wheel 3.38x2.63x1.967x0.935
S338	310101	Wheel 3.38x2.63x1.979x1.242
S339	310110	Wheel 3.38x2.63x2.047x0.67
S339	310111	Wheel 3.35x2.63x2.047x0.76
S341	310103	Wheel 4x2.63x2.44x0.77
S342	310105	Wheel 4x2.5x1.938x0.96
S343	310106	Wheel 4x3.62x2.44x0.77
S344	310181	Wheel 4x2.88x2.44x0.832
S345	077086	Wheel 3.25x5x2.047x0.59
S346	310114	Wheel 4x2.5x2.047x0.76
S351	310104	Wheel 5x2.62x2.834x0.77
S353	310102	Wheel 5x3.62x2.834x0.76
S354	310116	Wheel 5x3.75x2.834x0.74
S359	310113	Wheel 3.35x5.74x2.047x1.452
S362	310109	Wheel 6x4x2.834x1.17
S366	310154	Wheel 6x3.94x2.872x1.224
S372	310107	Wheel 7x2.5x2.328xNon Typical
S376	310115	Wheel 5x3x2.834x0.74
S377	310116	Wheel 5x3.75x2.834x0.74
S393	310117	Wheel 9x5x3.542x0.787 Black
S395	310117	Wheel 9x5x3.542x0.787 Black
S399	310112	Wheel 3.38x2.63x2.047x1.137
S502	310108	Wheel 4x1.88x2.44x0.76
S529	310144	Wheel 3.25x6x2.047x0.812
S9811	077086	Wheel 3.25x5x2.047x0.59
S9842	310181	Wheel 4x2.88x2.44x0.832
S9862	310154	Wheel 6x3.94x2.872x1.224
SP0766-508	310199	Tire Poly 8x4x6.5
Hyster (HY)		
105	077086	Wheel 3.25x5x2.047x0.59

Note: Add the compound part number to the base number listed above. Wheel compounds listed on page 11.03 (Format: XXXXXX-XXX.) and tire compounds and treads listed on page 11.19 (Format: XXXXXX-XXX-XX).

Hyster Continued ▶

Wheel & Tire Cross References

Continued ▶

Hyster Continued

OE Number	Crown Base Part No.	Description
108	310174	Wheel 3.25x4x1.85x0.551
124	310135	Wheel 3.25x3.25x2.047x0.825
132	310137	Wheel 3.25x4.28x2.047x0.825
133	310136	Wheel 3.25x4.71x2.047x0.825
134	310138	Wheel 3.25x5.75x2.047x0.825
143	310183	Wheel 4x2.75x2.44x0.843
153	312360	Wheel 5x3.88x2.05x0.60
202	310164	Wheel 5x2.88x2.047x0.59
203	073961	Wheel 4x2.88x2.047x0.59
312	310132	Wheel 6x3x2.047x0.595
354	310116	Wheel 5x3.75x2.834x0.74
371	310134	Wheel 6x3x2.44x0.775
377	310133	Wheel 5x2.88x2.44x0.775
383	310139	Wheel 5x2.5x1.939x0.95
386	310091	Wheel 7.88x2.48x2.047xNon Typical
420	154840	Wheel 3.25x2x2.047x0.59
423	310174	Wheel 3.25x4x1.85x0.551
425	310137	Wheel 3.25x4.28x2.047x0.825
429	310138	Wheel 3.25x5.75x2.047x0.825
435	310145	Wheel 3.25x6.25x2.047x0.812
441	310136	Wheel 3.25x4.71x2.047x0.825
442	310135	Wheel 3.25x3.25x2.047x0.825
445	310135	Wheel 3.25x3.25x2.047x0.825
452	310094	Wheel 4x2x1.575x0.575
455	310139	Wheel 5x2.5x1.939x0.95
459	310134	Wheel 6x3x2.44x0.775
467	310132	Wheel 6x3x2.047x0.595
553	310133	Wheel 5x2.88x2.44x0.775
606	310091	Wheel 7.88x2.48x2.047xNon Typical
641	073961	Wheel 4x2.88x2.047x0.59
647	310094	Wheel 4x2x1.575x0.575
653	310164	Wheel 5x2.88x2.047x0.59
806	310245	Wheel 3.25x4.5x2.047x.710
815	310093	Wheel 3.25x6.5x1.98x1.177
828	083179	Wheel 4x2.50x2.047x0.59
9133	077084	Wheel 3.25x3.25x2.047x0.59
9143	083179	Wheel 4x2.50x2.047x0.59
9811	077086	Wheel 3.25x5x2.047x0.59
103219	073961	Wheel 4x2.88x2.047x0.59
206435	073961	Wheel 4x2.88x2.047x0.59
207444	310135	Wheel 3.25x3.25x2.047x0.825
211349	077086	Wheel 3.25x5x2.047x0.59
213841	310143	Wheel 5x2.88x2.44x0.75
223853	310174	Wheel 3.25x4x1.85x0.551
230711	310164	Wheel 5x2.88x2.047x0.59
239145	310135	Wheel 3.25x3.25x2.047x0.825
267314	077086	Wheel 3.25x5x2.047x0.59
267317	310135	Wheel 3.25x3.25x2.047x0.825
267318	077086	Wheel 3.25x5x2.047x0.59
281070	310094	Wheel 4x2x1.575x0.575
326410	310094	Wheel 4x2x1.575x0.575
338604	077050	Tire Poly 13.5x5.5x8 Contour
340480	310139	Wheel 5x2.5x1.939x0.95
350534	310138	Wheel 3.25x5.75x2.047x0.825
350561	310135	Wheel 3.25x3.25x2.047x0.825
350562	310137	Wheel 3.25x4.28x2.047x0.825
350563	310136	Wheel 3.25x4.71x2.047x0.825
350564	310138	Wheel 3.25x5.75x2.047x0.825
354575	310135	Wheel 3.25x3.25x2.047x0.825
354576	310137	Wheel 3.25x4.28x2.047x0.825
354577	310136	Wheel 3.25x4.71x2.047x0.825
354578	310138	Wheel 3.25x5.75x2.047x0.825
358719	077050	Tire Poly 13.5x5.5x8 Contour
358720	077050	Tire Poly 13.5x5.5x8 Contour
365649	310095	Wheel 5x2.88x2.047x0.625
389630	310091	Wheel 7.88x2.48x2.047xNon Typical
813378	310048	Tire Poly 15x5x11.25
813421	310048	Tire Poly 15x5x11.25
885900	310061	Tire Poly 16x6x10.5

OE Number	Crown Base Part No.	Description
1032195	073961	Wheel 4x2.88x2.047x0.59
1048320	310134	Wheel 6x3x2.44x0.775
1098878	310013	Tire Poly 10x6x6.25
1151016	310132	Wheel 6x3x2.047x0.595
1152781	154840	Wheel 3.25x2x2.047x0.59
1195247	310132	Wheel 6x3x2.047x0.595
1195954	077086	Wheel 3.25x5x2.047x0.59
1195955	077086	Wheel 3.25x5x2.047x0.59
1196008	073961	Wheel 4x2.88x2.047x0.59
1196100	310174	Wheel 3.25x4x1.85x0.551
1196530	073961	Wheel 4x2.88x2.047x0.59
1196604	310164	Wheel 5x2.88x2.047x0.59
1196605	077086	Wheel 3.25x5x2.047x0.59
1196637	310095	Wheel 5x2.88x2.047x0.625
1196869	310145	Wheel 3.25x6.25x2.047x0.812
1196908	154840	Wheel 3.25x2x2.047x0.59
1197013	310143	Wheel 5x2.88x2.44x0.75
1300306	310091	Wheel 7.88x2.48x2.047xNon Typical
1457073	083179	Wheel 4x2.50x2.047x0.59
1492445	073961	Wheel 4x2.88x2.047x0.59
1492447	310134	Wheel 6x3x2.44x0.775
1548228	310239	Wheel 6x3.89x3.149x.828
2013297	310094	Wheel 4x2x1.575x0.575
2033219	310131	Wheel 8.5x2.66x2.754xNon Typical
2039298	310240	Wheel 3.25x6.5x2.047x1.00
2039299	100462	Wheel 3.25x6.5x2.047x1.44
2039299	310041	Wheel 3.25x6.5x2.047x1.681
2039300	310241	Wheel 3.25x3.125x2.047x.975
2045917	083179	Wheel 4x2.50x2.047x0.59
2046054	310245	Wheel 3.25x4.5x2.047x.710
2066073	310259	Wheel 5x4x2.44x0.63
2066239	310312	Wheel 4x2.5x2.440x0.67
2086327	310239	Wheel 6x3.875x3.149x0.828
2091428	083179	Wheel 4x2.50x2.047x0.59
2302342	310183	Wheel 4x2.75x2.44x0.843
2302392	310185	Wheel 3.25x4.5x1.575x0.56
2302427	370355	Wheel Rubber 5x5x5x2.19
2305605	310164	Wheel 5x2.88x2.047x0.59
2306047	312360	Wheel 5x3.88x2.05x0.60
2307117	312360	Wheel 5x3.88x2.05x0.60
2307857	073961	Wheel 4x2.88x2.047x0.59
2308415	310094	Wheel 4x2x1.575x0.575
2309701	310095	Wheel 5x2.88x2.047x0.625
2309954	107933	Tire Poly 10x5x6.5 Contour
3005911	310185	Wheel 3.25x4.5x1.575x0.56
3005984	310164	Wheel 5x2.88x2.047x0.59
3005987	073961	Wheel 4x2.88x2.047x0.59
3012693	083586	Wheel 5x2.88x3.149x0.98
3012707	077086	Wheel 3.25x5x2.047x0.59
3012710	100462	Wheel 3.25x6.5x2.047x1.44
3012931	154840	Wheel 3.25x2x2.047x0.59
3012933	310174	Wheel 3.25x4x1.85x0.551
3012947	310164	Wheel 5x2.88x2.047x0.59
3012949	310134	Wheel 6x3x2.44x0.775
3012966	310144	Wheel 3.25x6x2.047x0.812
3013015	075999	Wheel
3013115	075999	Wheel
3013116	082021	Wheel 6x2.75x3.149x0.83
3013117	082443	Wheel 2.50x2.06x1.187
3013122	082020	Wheel 6x4.25x3.149x0.83
3013133	081645	Wheel Poly
3013134	083585	Wheel 4x2.88x2.047x0.75
3013137	083587	Wheel 5x4.12x3.149x0.98
3013173	073961	Wheel 4x2.88x2.047x0.59
3017646	310131	Wheel 8.5x2.66x2.754xNon Typical
3020006	071894	Wheel 4 Poly
3021893	310071	Tire Poly 18x8x12.125
3021924	310012	Tire Poly 10x5x6.5
3021936	310061	Tire Poly 16x6x10.5

WHEELS AND TIRES

Note: Add the compound part number to the base number listed above. Wheel compounds listed on page 11.03 (Format: XXXXX-XXX.) and tire compounds and treads listed on page 11.19 (Format: XXXXX-XXX-XX).

Hyster Continued ▶

Hydrier Continued

OE Number	Crown Base Part No.	Description
3021949	077848	Tire Poly 9x5x5
3022125	077848	Tire Poly 9x5x5
3022375	310060	Tire Poly 16x5x10.5
3022382	310014	Tire Poly 10x6x6.5
3022517	310075	Tire Poly 22x8x16
3022554	107933	Tire Poly 10x5x6.5 Contour
3022555	310022	Tire Poly 10.5x6x6.5
3022556	310025	Tire Poly 12x4.5x8
3022557	310042	Tire Poly 14x4.5x8
3022558	310068	Tire Poly 18x6x12.125
3022571	075715	Tire Poly 10x4x6.5
3022601	310061	Tire Poly 16x6x10.5
3022612	310072	Tire Poly 18x9x12.125
3022782	077984	Tire Poly 8.5x4x4
3022806	310014	Tire Poly 10x6x6.5
3022937	310076	Tire Poly 22x10x16
3023045	310060	Tire Poly 16x5x10.5
3025553	310067	Tire Poly 18x5x12.125
3025565	310207	Tire Poly 22x9x16
3026131	310024	Tire Poly 10.5x7x6.5
3026509	077050	Tire Poly 13.5x5.5x8 Contour
3027350	310048	Tire Poly 15x5x11.25
3027736	310024	Tire Poly 10.5x7x6.5
3027773	154840	Wheel 3.25x2x2.047x0.59
3028194	077848	Tire Poly 9x5x5
3028200	075715	Tire Poly 10x4x6.5
3028227	310207	Tire Poly 22x9x16
3028670	077848	Tire Poly 9x5x5
3029013	077848	Tire Poly 9x5x5
3029017	075715	Tire Poly 10x4x6.5
3030218	077984	Tire Poly 8.5x4x4
3030223	075715	Tire Poly 10x4x6.5
3030828	075715	Tire Poly 10x4x6.5
3031330	310131	Wheel 8.5x2.66x2.754xNon Typical
3032897	310178	Wheel 3.25x5.91x2.047x1.18
3051525	310093	Wheel 3.25x6.5x1.98x1.177
3056709	310091	Wheel 7.88x2.48x2.047xNon Typical
3056852	310164	Wheel 5x2.88x2.047x0.59
3068626	077086	Wheel 3.25x5x2.047x0.59
3102707	077086	Wheel 3.25x5x2.047x0.59
3120636	107933	Tire Poly 10x5x6.5 Contour
3120637	077848	Tire Poly 9x5x5
3120638	310025	Tire Poly 12x4.5x8
3121144	082021	Load Wheel Assm 6x2.75
3126223	081520	Wheel Caster Assm 10 x 3
3133013	115033	Wheel 5x4.12x2.44x0.83
3133017	310181	Wheel 4x2.88x2.44x0.832
4609400	310245	Wheel 3.25x4.5x2.047x.710
754507300	310091	Wheel 7.88x2.48x2.047xNon Typical
800017067	123603	Load Wheel Assm 3.25 x 4.50
800017230	125070	Wheel 6x4.12x3.149x0.98
800017585	127723	Wheel Caster 8x4x2.83
800020380	077084	Load Wheel Assm 3.25x3.25
800020380	092537	Wheel Assm 3.25x3.25x2.047x0.59
800026169	310131	Wheel 8.5x2.66x2.754xNon Typical
800045244	083586	Wheel 5x2.88x3.149x0.98
800045250	310131	Wheel 8.5x2.66x2.754xNon Typical
800045277	125070	Wheel 6x4.12x3.149x0.98
800045371	083879	Roller Load
800046166	073602	Wheel 5 Steel Assm
800046167	125069	Wheel 6x2.88x3.15x0.80
800050148	100462	Wheel 3.25x6.5x2.047x1.44
800050156	115032	Wheel 5x2.88x2.44x0.83
800076056	071894	Wheel 4 Poly
800076068	073602	Wheel 5 Steel Assm
800076205	082741	Wheel Nylon
800076404	082283	Wheel Assm (Poly)
800113692	044507	Roller Poly
800114768	072718	Wheel Assm Poly

OE Number	Crown Base Part No.	Description
800114775	071892	Wheel 5 dia
800114779	071665	Wheel Polyurethane
800114783	082021	Wheel 6x2.75x3.149x0.83
800114787	077084	Load Wheel Assm 3.25x3.25
800114787	092537	Wheel Assm 3.25x3.25x2.047x0.59
800114789	125069	Wheel 6x2.88x3.15x0.80
800114802	311520	Wheel 10x3 Caster
800114805	077084	Load Wheel Assm 3.25x3.25
800114805	092537	Wheel Assm 3.25x3.25x2.047x0.59
800114810	077086	Wheel 3.25x5x2.047x0.59
800114812	115033	Wheel 5x4.12x2.44x0.83
800114818	100462	Wheel 3.25x6.5x2.047x1.44
800114833	083179	Wheel 4x2.50x2.047x0.59
800114837	083585	Wheel 4x2.88x2.047x0.75
800114838	083585	Wheel 4x2.88x2.047x0.75
800114845	088628	Wheel 4x4.12x2.047x0.75
800114846	088628	Wheel 4x4.12x2.047x0.75
800114848	115032	Wheel 5x2.88x2.44x0.83
800114851	083587	Wheel 5x4.12x3.149x0.98
800114853	083586	Wheel 5x2.88x3.149x0.98
800114856	115033	Wheel 5x4.12x2.44x0.83
800114858	115033	Wheel 5x4.12x2.44x0.83
800120656	123603	Wheel 3.25x4.50x2.16x0.52
800120779	310131	Wheel 8.5x2.66x2.754xNon Typical
800120802	115032	Wheel 5x2.88x2.44x0.83
C32195	073961	Wheel 4x2.88x2.047x0.59
C-32195	073961	Wheel 4x2.88x2.047x0.59
C33557	310132	Wheel 6x3x2.047x0.595
C33735	310164	Wheel 5x2.88x2.047x0.59
C33746	077086	Wheel 3.25x5x2.047x0.59
C34835	077084	Wheel 3.25x3.25x2.047x0.59
C34836	310135	Wheel 3.25x3.25x2.047x0.825
C426173	154840	Wheel 3.25x2x2.047x0.59
C426174	154840	Wheel 3.25x2x2.047x0.59
C46239	310133	Wheel 5x2.88x2.44x0.775
C46239	310143	Wheel 5x2.88x2.44x0.75
C48320	310134	Wheel 6x3x2.44x0.775
C60088	310174	Wheel 3.25x4x1.85x0.551
C-60088	310174	Wheel 3.25x4x1.85x0.551
HYC-20196	077086	Wheel 3.25x5x2.047x0.59
HYC-20197	077086	Wheel 3.25x5x2.047x0.59
L309088	310116	Wheel 5x3.75x2.834x0.74
S143	310183	Wheel 4x2.75x2.44x0.843
S153	312360	Wheel 5x3.88x2.05x0.60
S420	154840	Wheel 3.25x2x2.047x0.59
S423	310174	Wheel 3.25x4x1.85x0.551
S425	310137	Wheel 3.25x4.28x2.047x0.825
S429	310138	Wheel 3.25x5.75x2.047x0.825
S434	077086	Wheel 3.25x5x2.047x0.59
S435	310145	Wheel 3.25x6.25x2.047x0.812
S438	310135	Wheel 3.25x3.25x2.047x0.825
S441	310136	Wheel 3.25x4.71x2.047x0.825
S442	310135	Wheel 3.25x3.25x2.047x0.825
S443	073961	Wheel 4x2.88x2.047x0.59
S444	310137	Wheel 3.25x4.28x2.047x0.825
S445	310136	Wheel 3.25x4.71x2.047x0.825
S446	310137	Wheel 3.25x4.28x2.047x0.825
S447	077086	Wheel 3.25x5x2.047x0.59
S448	310138	Wheel 3.25x5.75x2.047x0.825
S450	310133	Wheel 5x2.88x2.44x0.775
S451	310164	Wheel 5x2.88x2.047x0.59
S452	310094	Wheel 4x2x1.575x0.575
S456	310139	Wheel 5x2.5x1.939x0.95
S457	312360	Wheel 5x3.88x2.05x0.60
S459	310134	Wheel 6x3x2.44x0.775
S467	310132	Wheel 6x3x2.047x0.595
S487	310091	Wheel 7.88x2.48x2.047xNon Typical
S529	310144	Wheel 3.25x6x2.047x0.812
S553	310133	Wheel 5x2.88x2.44x0.775

Note: Add the compound part number to the base number listed above. Wheel compounds listed on page 11.03 (Format: XXXXXX-XXX.) and tire compounds and treads listed on page 11.19 (Format: XXXXXX-XXX-XX).

Hyster Continued ▶

Wheel & Tire Cross References

Continued ▶

Hyster Continued

OE Number	Crown Base Part No.	Description
S647	310094	Wheel 4x2x1.575x0.575
S648	310094	Wheel 4x2x1.575x0.575
S653	310164	Wheel 5x2.88x2.047x0.59
S673	310172	Wheel 6x3.63x2.44x0.668
S700	310178	Wheel 3.25x5.91x2.047x1.18
S815	310093	Wheel 3.25x6.5x1.98x1.177
S820	310185	Wheel 3.25x4.5x1.575x0.56
S9534	310174	Wheel 3.25x4x1.85x0.551
S9842	310181	Wheel 4x2.88x2.44x0.832
Jungheinrich (JU)		
32086	310296	Tire Poly 9x2.875x6.63
822785	082285	Wheel (Nylon)
50432647	310467	Caster Wheel Assembly
6311846	807557	Drive Tire Assembly ESR4500
6314589	807557	Drive Tire Assembly ESR4500
7180668	370231	Load Wheel Assembly
50136157	370231	Load Wheel Assembly
50460101	370220	JU50460101 Drive Tire
63118460	807557	Drive Tire Assembly ESR4500
63145890	807557	Drive Tire Assembly ESR4500
71305290	370231	Load Wheel Assembly
71806680	370231	Load Wheel Assembly
Komatsu (KO)		
8773965	136247	Tube 6.00-9 Tire - 600/690x9
8779048	136243	Tube 7.00-12 Tire - 700/825x12
8779866	355500	Solid Resi 500x8 3" TR
MIT27218501	355500	Solid Resi 500x8 3" TR
MIT42300000	136247	Tube 6-9 Tire - 600/690x9
MIT42400000	136243	Tube 7.00-12 Tire - 700/825x12
OP03000205	310029	Tire Poly 12x5x9
Lansing (LA)		
1004018-001	154840	Wheel 3.25x2x2.047x0.59
1410	154840	Wheel 3.25x2x2.047x0.59
1415	310174	Wheel 3.25x4x1.85x0.551
2029211-001	310142	Wheel 4x2.88x2.44x0.75
2029242-001	310096	Wheel 6x2x2.44x0.625
78435	310098	Wheel 4x2.75x1.938xThru
S1404	310174	Wheel 3.25x4x1.85x0.551
S1410	154840	Wheel 3.25x2x2.047x0.59
S1415	310174	Wheel 3.25x4x1.85x0.551
Lift Rite (LR)		
102	310182	Wheel 3x4x1.85x0.56
10210	310182	Wheel 3x4x1.85x0.56
10210P	310182	Wheel 3x4x1.85x0.56
302	310090	Wheel 8x2x2.047x0.595
302	310092	Wheel 8x2x2.047x0.67
783	310090	Wheel 8x2x2.047x0.595
783	310092	Wheel 8x2x2.047x0.67
82	310090	Wheel 8x2x2.047x0.595
82	310092	Wheel 8x2x2.047x0.67
B40220	310090	Wheel 8x2x2.047x0.595
B40220	310092	Wheel 8x2x2.047x0.67
S10210	310182	Wheel 3x4x1.85x0.56
S10212	310182	Wheel 3x4x1.85x0.56
S10237	310090	Wheel 8x2x2.047x0.595
S10237	310092	Wheel 8x2x2.047x0.67
Linde (LI)		
102	310189	Wheel 3x3.5x1.85x0.56
103	310141	Wheel 3.25x3x2.047x0.812
106	310146	Wheel 3.25x6.38x2.047x0.812
107	310140	Wheel 3.25x3.88x2.047x.812
109	310145	Wheel 3.25x6.25x2.047x0.812
111	154840	Wheel 3.25x2x2.047x0.59
117	310185	Wheel 3.25x4.5x1.575x0.56
138	154840	Wheel 3.25x2x2.047x0.59
202	310164	Wheel 5x2.88x2.047x0.59
203	073961	Wheel 4x2.88x2.047x0.59
207	071894	Wheel 4 Poly
306	310132	Wheel 6x3x2.047x0.595

OE Number	Crown Base Part No.	Description
306	310177	Wheel 6x3x2.047x0.67
319	310179	Wheel 8x4x2.44x0.656
377	310133	Wheel 5x2.88x2.44x0.775
377	310143	Wheel 5x2.88x2.44x0.75
443	073961	Wheel 4x2.88x2.047x0.59
502	310108	Wheel 4x1.88x2.44x0.76
532	310149	Wheel 3.25x3x2.047x0.656
534	310145	Wheel 3.25x6.25x2.047x0.812
535	310141	Wheel 3.25x3x2.047x0.812
538	310140	Wheel 3.25x3.88x2.047x.812
539	310190	Wheel 3.25x6.38x2.047x1.187
542	310142	Wheel 4x2.88x2.44x0.75
553	310133	Wheel 5x2.88x2.44x0.775
553	310143	Wheel 5x2.88x2.44x0.75
560	310132	Wheel 6x3x2.047x0.595
560	310177	Wheel 6x3x2.047x0.67
581	310179	Wheel 8x4x2.44x0.656
630	310162	Wheel 3.38x2.25x1.85x0.551
641	073961	Wheel 4x2.88x2.047x0.59
647	310094	Wheel 4x2x1.575x0.575
653	310164	Wheel 5x2.88x2.047x0.59
820	310185	Wheel 3.25x4.5x1.575x0.56
900	310147	Wheel 3.25x6x2.047x1.187
985	310080	Wheel 3x2x2.047x0.625
9143	083179	Wheel 4x2.50x2.047x0.59
9433	310189	Wheel 3x3.5x1.85x0.56
9841	071894	Wheel 4 Poly
3-4	310179	Wheel 8x4x2.44x0.656
4-1	310179	Wheel 8x4x2.44x0.656
116808	310207	Tire Poly 22x9x16
127223	310121	Tire Poly 21x8x15
138937	310142	Wheel 4x2.88x2.44x0.75
146735	083179	Wheel 4x2.50x2.047x0.59
152681	310218	Wheel 3.25x6.38x2.047x1.062
154423	310218	Wheel 3.25x6.38x2.047x1.062
160948	310231	Wheel 3.25x4.84x2.047x0.8
632078	310179	Wheel 8x4x2.44x0.656
703637	310108	Wheel 4x1.88x2.44x0.76
708086	310146	Wheel 3.25x6.38x2.047x0.812
708367	073961	Wheel 4x2.88x2.047x0.59
985189	310164	Wheel 5x2.88x2.047x0.59
993474	310132	Wheel 6x3x2.047x0.595
993474	310177	Wheel 6x3x2.047x0.67
994070	310179	Wheel 8x4x2.44x0.656
9904070	310179	Wheel 8x4x2.44x0.656
9815001933	310067	Tire Poly 18x5x12.125
106A	310144	Wheel 3.25x6x2.047x0.812
13HP	310189	Wheel 3x3.5x1.85x0.56
632-078	310179	Wheel 8x4x2.44x0.656
BHP014	310189	Wheel 3x3.5x1.85x0.56
LIAW-3-4	310179	Wheel 8x4x2.44x0.656
LIAW-4-1	310179	Wheel 8x4x2.44x0.656
LIS530	310250	Wheel 3.25x1.88x2.047x0.595
MO108	310080	Wheel 3x2x2.047x0.625
PAL 13	310145	Wheel 3.25x6.25x2.047x0.812
PAL13-A	310149	Wheel 3.25x3x2.047x0.656
PAL13-C	310149	Wheel 3.25x3x2.047x0.656
PAL13-GH	310140	Wheel 3.25x3.88x2.047x.812
PAL13-GL	310141	Wheel 3.25x3x2.047x0.812
PAL13-GLD	310149	Wheel 3.25x3x2.047x0.656
PAL13-K	310140	Wheel 3.25x3.88x2.047x.812
PAL13-KG	310140	Wheel 3.25x3.88x2.047x.812
PAL13-M	310144	Wheel 3.25x6x2.047x0.812
S443	073961	Wheel 4x2.88x2.047x0.59
S524	310162	Wheel 3.38x2.25x1.85x0.551
S525	310080	Wheel 3x2x2.047x0.625
S528	310146	Wheel 3.25x6.38x2.047x0.812
S529	310144	Wheel 3.25x6x2.047x0.812
S530	310250	Wheel 3.25x1.88x2.047x0.595

WHEELS AND TIRES

Note: Add the compound part number to the base number listed above. Wheel compounds listed on page 11.03 (Format: XXXXX-XXX) and tire compounds and treads listed on page 11.19 (Format: XXXXX-XXX-XX).

Linde Continued ▶

Linde Continued

OE Number	Crown Base Part No.	Description
S532	310149	Wheel 3.25x3x2.047x0.656
S533	310189	Wheel 3x3.5x1.85x0.56
S534	310145	Wheel 3.25x6.25x2.047x0.812
S534-S	310146	Wheel 3.25x6.38x2.047x0.812
S535	310141	Wheel 3.25x3x2.047x0.812
S538	310140	Wheel 3.25x3.88x2.047x.812
S542	310142	Wheel 4x2.88x2.44x0.75
S544	073961	Wheel 4x2.88x2.047x0.59
S548	310094	Wheel 4x2x1.575x0.575
S552	310164	Wheel 5x2.88x2.047x0.59
S553	310133	Wheel 5x2.88x2.44x0.775
S553	310143	Wheel 5x2.88x2.44x0.75
S560	310132	Wheel 6x3x2.047x0.595
S560	310177	Wheel 6x3x2.047x0.67
S581	310179	Wheel 8x4x2.44x0.656
S591	310108	Wheel 4x1.88x2.44x0.76
S820	310185	Wheel 3.25x4.5x1.575x0.56
S985	310080	Wheel 3x2x2.047x0.625
W2-G	310080	Wheel 3x2x2.047x0.625
W3-6G	310132	Wheel 6x3x2.047x0.595
W3-6G	310177	Wheel 6x3x2.047x0.67
W413923	310162	Wheel 3.38x2.25x1.85x0.551
Mitsubishi (MB)		
301	310102	Wheel 5x3.62x2.834x0.76
302	310087	Wheel 7x2.86x2.047xNon Typical
353	310102	Wheel 5x3.62x2.834x0.76
560	310177	Wheel 6x3x2.047x0.67
635	310077	Wheel 3.25x5.88x2.047x0.599
700	310178	Wheel 3.25x5.91x2.047x1.18
9143	083179	Wheel 4x2.50x2.047x0.59
9811	077086	Wheel 3.25x5x2.047x0.59
9827	310087	Wheel 7x2.86x2.047xNon Typical
67018	083179	Wheel 4x2.50x2.047x0.59
289069	310178	Wheel 3.25x5.91x2.047x1.18
1009234	310178	Wheel 3.25x5.91x2.047x1.18
1009591	310178	Wheel 3.25x5.91x2.047x1.18
1029602	310178	Wheel 3.25x5.91x2.047x1.18
1029607	310178	Wheel 3.25x5.91x2.047x1.18
1029609	310178	Wheel 3.25x5.91x2.047x1.18
1029612	310178	Wheel 3.25x5.91x2.047x1.18
1050142	310179	Wheel 8x4x2.44x0.656
1050236	310179	Wheel 8x4x2.44x0.656
1075061	077086	Wheel 3.25x5x2.047x0.59
1075062	077086	Wheel 3.25x5x2.047x0.59
1075063	077086	Wheel 3.25x5x2.047x0.59
1075064	077086	Wheel 3.25x5x2.047x0.59
1201773	310178	Wheel 3.25x5.91x2.047x1.18
10092234	310178	Wheel 3.25x5.91x2.047x1.18
50136157	370231	Load Wheel Assembly
50179921	370231	Load Wheel Assembly
50432647	310467	Caster Wheel Assembly
71305290	370231	Load Wheel Assembly
452204620	083179	Wheel 4x2.50x2.047x0.59
10236B	310092	Wheel 8x2x2.047x0.67
4522-04620	083179	Wheel 4x2.50x2.047x0.59
4522-33000	310077	Wheel 3.25x5.88x2.047x0.599
4522-35050	310177	Wheel 6x3x2.047x0.67
4621-27282	310087	Wheel 7x2.86x2.047xNon Typical
4690-03540	310087	Wheel 7x2.86x2.047xNon Typical
4770-30250	310115	Wheel 5x3x2.834x0.74
4780-30230	310102	Wheel 5x3.62x2.834x0.76
4B43971	310102	Wheel 5x3.62x2.834x0.76
MBNA067018	083179	Wheel 4x2.50x2.047x0.59
S353	310102	Wheel 5x3.62x2.834x0.76
S9751	310077	Wheel 3.25x5.88x2.047x0.599
S9752	083179	Wheel 4x2.50x2.047x0.59
S9754	310102	Wheel 5x3.62x2.834x0.76
S9755	310177	Wheel 6x3x2.047x0.67
S9773	310087	Wheel 7x2.86x2.047xNon Typical

OE Number	Crown Base Part No.	Description
S9827	310087	Wheel 7x2.86x2.047xNon Typical
W2050-11106	370231	Load Wheel Assembly
W2050-12884	310467	Caster Wheel Assembly
Multiton (MT)		
9534	310174	Wheel 3.25x4x1.85x0.551
90304	310174	Wheel 3.25x4x1.85x0.551
90326	310174	Wheel 3.25x4x1.85x0.551
325P	310174	Wheel 3.25x4x1.85x0.551
A212	310174	Wheel 3.25x4x1.85x0.551
MTA212	310174	Wheel 3.25x4x1.85x0.551
S9534	310174	Wheel 3.25x4x1.85x0.551
Nissan (NI)		
253	310144	Wheel 3.25x6x2.047x0.812
4035-FS000	310144	Wheel 3.25x6x2.047x0.812
SP0766-508	310199	Tire Poly 8x4x6.5
Palletmaster (PS)		
82	310090	Wheel 8x2x2.047x0.595
82	310092	Wheel 8x2x2.047x0.67
Prime Mover (PM)		
103	310150	Wheel 3.25x2.94x1.98xNon Typical
104	310149	Wheel 3.25x3x2.047x0.656
105	077086	Wheel 3.25x5x2.047x0.59
201	310153	Wheel 4x2.88x2.325x0.832
202	310152	Wheel 4x2.75x1.938xThru
203	310181	Wheel 4x2.88x2.44x0.832
206	310221	Wheel 4x1.92x1.781x.84
207	071894	Wheel 4 Poly
211	310186	Wheel 4x2.37x1.938x0.96
301	310148	Wheel 8x1.90x1.98x0.81
305	310151	Wheel 5x2.88x2.325x0.832
306	310154	Wheel 6x3.94x2.872x1.224
309	310155	Wheel 7x2.5x2.326xNon Typical
321	310104	Wheel 5x2.62x2.834x0.77
351	310104	Wheel 5x2.62x2.834x0.77
353	310102	Wheel 5x3.62x2.834x0.76
644	310221	Wheel 4x1.92x1.781x.84
824	310186	Wheel 4x2.37x1.938x0.96
900	310147	Wheel 3.25x6x2.047x1.187
901	310090	Wheel 8x2x2.047x0.595
2335	310244	Wheel 3.25x4.5x2.047x.594
9112	082443	Wheel 2.50x2.06x1.187
9143	083179	Wheel 4x2.50x2.047x0.59
9800	310212	Wheel 3.25x3x2.047x.590
9803	310153	Wheel 4x2.88x2.325x0.832
9804	310150	Wheel 3.25x2.94x1.98xNon Typical
9805	310151	Wheel 5x2.88x2.325x0.832
9806	310149	Wheel 3.25x3x2.047x0.656
9808	310152	Wheel 4x2.75x1.938xThru
9810	310085	Wheel 3.25x6x2.047x0.585
9811	077086	Wheel 3.25x5x2.047x0.59
9841	071894	Wheel 4 Poly
9842	310181	Wheel 4x2.88x2.44x0.832
9844	310235	Wheel 4x2.88x2.44x0.672
9862	310154	Wheel 6x3.94x2.872x1.224
9870	310155	Wheel 7x2.5x2.326xNon Typical
9880	310148	Wheel 8x1.90x1.98x0.81
13864	310148	Wheel 8x1.90x1.98x0.81
15881	310189	Wheel 3x3.5x1.85x0.56
20001	310186	Wheel 4x2.37x1.938x0.96
22006	107933	Tire Poly 10x5x6.5 Contour
25922	310020	Tire Poly 10.5x5x6.5
27625	310149	Wheel 3.25x3x2.047x0.656
27808	083179	Wheel 4x2.50x2.047x0.59
40868	310181	Wheel 4x2.88x2.44x0.832
42125	310102	Wheel 5x3.62x2.834x0.76
200015	310186	Wheel 4x2.37x1.938x0.96
204274	083179	Wheel 4x2.50x2.047x0.59
301738	310020	Tire Poly 10.5x5x6.5
303692	310104	Wheel 5x2.62x2.834x0.77

Note: Add the compound part number to the base number listed above. Wheel compounds listed on page 11.03 (Format: XXXXX-XXX.) and tire compounds and treads listed on page 11.19 (Format: XXXXX-XXX-XX).

Prime Mover Continued ▶

Wheel & Tire Cross References

Continued ▶

Prime Mover Continued

OE Number	Crown Base Part No.	Description
305622	310053	Tire Poly 13.5x5.5x10
305624	310039	Tire Poly 13.5x5.5x8
306752	310053	Tire Poly 13.5x5.5x10
306895	310017	Tire Poly 10.5x3.5x8
309826	310053	Tire Poly 13.5x5.5x10
312636	310244	Wheel 3.25x4.5x2.047x.594
1612413	310104	Wheel 5x2.62x2.834x0.77
2324109	310102	Wheel 5x3.62x2.834x0.76
20071-01	310020	Tire Poly 10.5x5x6.5
23041-00	077086	Wheel 3.25x5x2.047x0.59
24269-00	310003	Tire Poly 8x4.5x4.5
25202-02	310153	Wheel 4x2.88x2.325x0.832
25922-01	310020	Tire Poly 10.5x5x6.5
27626-02	310085	Wheel 3.25x6x2.047x0.585
27626-03	310147	Wheel 3.25x6x2.047x1.187
27808-00	083179	Wheel 4x2.50x2.047x0.59
302623-002	310212	Wheel 3.25x3x2.047x.590
303692-00	310104	Wheel 5x2.62x2.834x0.77
305620-00	310227	Wheel 7x2.75x1.98
307110-03	310147	Wheel 3.25x6x2.047x1.187
312636-000	310316	Wheel 3.25x4.48x2.047x0.582
314275-000	310179	Wheel 8x4x2.44x0.656
314334-000	310179	Wheel 8x4x2.44x0.656
40254-00	107933	Tire Poly 10x5x6.5 Contour
40254-01	310018	Tire Poly 10.5x4.5x8
40265-00	107933	Tire Poly 10x5x6.5 Contour
40266-01	310039	Tire Poly 13.5x5.5x8
40721-00	310155	Wheel 7x2.5x2.326xNon Typical
40868-2	310181	Wheel 4x2.88x2.44x0.832
42125-00	310102	Wheel 5x3.62x2.834x0.76
42136-00	310235	Wheel 4x2.88x2.44x0.672
4522-04620	083179	Wheel 4x2.50x2.047x0.59
A26327	071894	Wheel 4 Poly
B20755	310150	Wheel 3.25x2.94x1.98xNon Typical
B20972	310150	Wheel 3.25x2.94x1.98xNon Typical
B25195	310152	Wheel 4x2.75x1.938xThru
B25199	310153	Wheel 4x2.88x2.325x0.832
B25761	310151	Wheel 5x2.88x2.325x0.832
B26327	071894	Wheel 4 Poly
B26460	310154	Wheel 6x3.94x2.872x1.224
B27042	310149	Wheel 3.25x3x2.047x0.656
B27042	310212	Wheel 3.25x3x2.047x.590
B27049	071894	Wheel 4 Poly
B-27606	310212	Wheel 3.25x3x2.047x.590
B27626-00	310147	Wheel 3.25x6x2.047x1.187
B27626-01	310085	Wheel 3.25x6x2.047x0.585
B-27626-03	310147	Wheel 3.25x6x2.047x1.187
B27674	310221	Wheel 4x1.92x1.781x.84
MB-26460	310159	Wheel 5x2x2.047x0.59
P-13863	310148	Wheel 8x1.90x1.98x0.81
P-13864	310148	Wheel 8x1.90x1.98x0.81
P21038	310152	Wheel 4x2.75x1.938xThru
P25199	310153	Wheel 4x2.88x2.325x0.832
PMA-26327	071894	Wheel 4 Poly
S901	310090	Wheel 8x2x2.047x0.595
S9143	083179	Wheel 4x2.50x2.047x0.59
S9803	310153	Wheel 4x2.88x2.325x0.832
S9804	310150	Wheel 3.25x2.94x1.98xNon Typical
S9805	310151	Wheel 5x2.88x2.325x0.832
S9806	310149	Wheel 3.25x3x2.047x0.656
S9811	077086	Wheel 3.25x5x2.047x0.59
S9812	310085	Wheel 3.25x6x2.047x0.585
S9813	310152	Wheel 4x2.75x1.938xThru
S9814	077086	Wheel 3.25x5x2.047x0.59
S9815	310147	Wheel 3.25x6x2.047x1.187
S9817	083179	Wheel 4x2.50x2.047x0.59
S9818	310221	Wheel 4x1.92x1.781x.84
S9819	310186	Wheel 4x2.37x1.938x0.96
S9841	071894	Wheel 4 Poly

OE Number	Crown Base Part No.	Description
S9842	310181	Wheel 4x2.88x2.44x0.832
S9843	071894	Wheel 4 Poly
S9850	310104	Wheel 5x2.62x2.834x0.77
S9854	310102	Wheel 5x3.62x2.834x0.76
S9862	310154	Wheel 6x3.94x2.872x1.224
S9870	310155	Wheel 7x2.5x2.326xNon Typical
S9880	310148	Wheel 8x1.90x1.98x0.81
X29050-00	082443	Wheel 2.50x2.06x1.187
X301738-00	310020	Tire Poly 10.5x5x6.5
XP20262-02X	310020	Tire Poly 10.5x5x6.5
Raymond (RA)		
101	310162	Wheel 3.38x2.25x1.85x0.551
115	310178	Wheel 3.25x5.91x2.047x1.18
116	310078	Wheel 3.25x2.88x2.047x0.59
201	310099	Wheel 4x2.75x2.047x0.59
202	310164	Wheel 5x2.88x2.047x0.59
204	310159	Wheel 5x2x2.047x0.59
206	310160	Wheel 5x3.63x2.44x0.668
208	310158	Wheel 4x3.62x2.047x0.59
210	310176	Wheel 4x2x2.44xNon Typical
303	310112	Wheel 3.38x2.63x2.047x1.137
314	310161	Wheel 6x2.5x2.327x1.967
317	310166	Wheel 6x2.5x1.938x0.937
318	310167	Wheel 6x3x2.44x0.68
319	310169	Wheel 6x4x2.835x0.668
321	310163	Wheel 6.88x2x2.835x0.97
325	310172	Wheel 6x3.63x2.44x0.668
326	310177	Wheel 6x3x2.047x0.67
327	310179	Wheel 8x4x2.44x0.656
338	310101	Wheel 3.38x2.63x1.979x1.242
341	310103	Wheel 4x2.63x2.44x0.77
535	310141	Wheel 3.25x3x2.047x0.812
623	310220	Wheel 3.25x1.75x1.850x.551
629	154840	Wheel 3.25x2x2.047x0.59
630	310162	Wheel 3.38x2.25x1.85x0.551
631	310156	Wheel 3.25x2.25x1.85x0.551
632	310176	Wheel 4x2x2.44xNon Typical
633	310157	Wheel 3.25x2.88x1.85x0.551
635	310144	Wheel 3.25x6x2.047x0.812
636	310078	Wheel 3.25x2.88x2.047x0.59
638	310219	Wheel 3.25x4.2x2.047x.590
641	073961	Wheel 4x2.88x2.047x0.59
644	310221	Wheel 4x1.92x1.781x.84
645	310158	Wheel 4x3.62x2.047x0.59
647	310094	Wheel 4x2x1.575x0.575
648	310099	Wheel 4x2.75x2.047x0.59
650	310159	Wheel 5x2x2.047x0.59
651	310173	Wheel 5x2x2.44xNon Typical
653	310164	Wheel 5x2.88x2.047x0.59
654	310160	Wheel 5x3.63x2.44x0.668
656	310168	Wheel 5x1.12x2.047xNon Typical
663	310161	Wheel 6x2.5x2.327x1.967
664	310167	Wheel 6x3x2.44x0.68
666	310169	Wheel 6x4x2.835x0.668
667	310166	Wheel 6x2.5x1.938x0.937
671	310163	Wheel 6.88x2x2.835x0.97
673	310172	Wheel 6x3.63x2.44x0.668
684	310179	Wheel 8x4x2.44x0.656
699	310177	Wheel 6x3x2.047x0.67
700	310178	Wheel 3.25x5.91x2.047x1.18
7711	310180	Wheel 3.25x4.2x2.047x1.18
9111	082021	Wheel 6x2.75x3.149x0.83
9117	082020	Wheel 6x4.25x3.149x0.83
9119	310131	Wheel 8.5x2.66x2.754xNon Typical
9136	100462	Wheel 3.25x6.5x2.047x1.44
9143	083179	Wheel 4x2.50x2.047x0.59
9151	083587	Wheel 5x4.12x3.149x0.98
9433	310189	Wheel 3x3.5x1.85x0.56
9534	310174	Wheel 3.25x4x1.85x0.551

WHEELS AND TIRES

Note: Add the compound part number to the base number listed above. Wheel compounds listed on page 11.03 (Format: XXXXX-XXX) and tire compounds and treads listed on page 11.19 (Format: XXXXX-XXX-XX).

Raymond Continued ▶

Raymond Continued

OE Number	Crown Base Part No.	Description
9811	077086	Wheel 3.25x5x2.047x0.59
224382	083179	Wheel 4x2.50x2.047x0.59
226864	310175	Wheel 3.25x5.91x2.047x0.590
226864	310178	Wheel 3.25x5.91x2.047x1.18
237271	073961	Wheel 4x2.88x2.047x0.59
309882-X01	310108	Wheel 4x1.88x2.44x0.75
310272	310272	Tire Poly 14.75x6.5x10.75
630051	310128	Wheel Poly 4x2.88x1.85x0.575
632139	310271	Tire Poly 14x8x10.25
632145	310463	Tire Poly 15x6.5x10.75
632163	310293	Tire Poly 9x7x6.25
939353	310244	Wheel 3.25x4.5x2.047x.594
1002754	310225	Wheel 6x3x1.9687
632069107	310178	Wheel 3.25x5.91x2.047x1.18
632087003	310008	Tire Poly 10x3.5x8
632126107	310046	Tire Poly 14x6x11.25
632145015	310463	Tire Poly 15x6.5x10.75
6632052107	310160	Wheel 5x3.63x2.44x0.668
015-114-007-561	310220	Wheel 3.25x1.75x1.850x.551
031-043-310	073961	Wheel 4x2.88x2.047x0.59
061-053-310	073961	Wheel 4x2.88x2.047x0.59
114-007-561	310220	Wheel 3.25x1.75x1.850x.551
15-201	073961	Wheel 4x2.88x2.047x0.59
23041-00	077086	Wheel 3.25x5x2.047x0.59
312636-000	310316	Wheel 3.25x4.5x2.047x.594
312728-000	310115	Wheel 5x3x2.834x0.74
313687-001	310102	Wheel 5x3.62x2.834x0.76
313716-001	077086	Wheel 3.25x5x2.047x0.59
313717-000	310147	Wheel 3.25x6x2.047x1.187
313717-001	310147	Wheel 3.25x6x2.047x1.187
313718-000	310085	Wheel 3.25x6x2.047x0.585
313721-001	083179	Wheel 4x2.50x2.047x0.59
313723-000	310235	Wheel 4x2.88x2.44x0.672
313724-000	310154	Wheel 6x3.94x2.872x1.224
314322-000	100462	Wheel 3.25x6.5x2.047x1.44
314325-000	310160	Wheel 5x3.63x2.44x0.668
314364-000	310244	Wheel 3.25x4.5x2.047x.594
314365-000	310244	Wheel 3.25x4.5x2.047x.594
314366-000	310244	Wheel 3.25x4.5x2.047x.594
314376-000	310210	Wheel 3.25x5.5x1.98x0.69
630-030	073961	Wheel 4x2.88x2.047x0.59
630-050	073961	Wheel 4x2.88x2.047x0.59
630-051	310128	Wheel Poly 4x2.88x1.85x0.575
630-229	310011	Tire Poly 10x4.75x6.5 Contour
630-229/002	350005	Rubber 10x4.75x6.5 SM NM
630-235	107933	Tire Poly 10x5x6.5 Contour
630-248	077050	Tire Poly 13.5x5.5x8 Contour
630-255	310065	Tire Poly 16.25x6x11.25
630-259	310065	Tire Poly 16.25x6x11.25
631-030	073961	Wheel 4x2.88x2.047x0.59
631-031	073961	Wheel 4x2.88x2.047x0.59
631-051	310164	Wheel 5x2.88x2.047x0.59
632/139	310271	Tire Poly 14x8x10.25
632/145	310463	Tire Poly 15x6.5x10.75
632-009	310156	Wheel 3.25x2.25x1.85x0.551
632-010	310162	Wheel 3.38x2.25x1.85x0.551
632-015	310144	Wheel 3.25x6x2.047x0.812
632-016	077086	Wheel 3.25x5x2.047x0.59
632-016-003	077086	Wheel 3.25x5x2.047x0.59
632-016-NL7	077086	Wheel 3.25x5x2.047x0.59
632-018	310078	Wheel 3.25x2.88x2.047x0.59
632-018/101	310078	Wheel 3.25x2.88x2.047x0.59
632-019	310157	Wheel 3.25x2.88x1.85x0.551
632-026	310176	Wheel 4x2x2.44xNon Typical
632-030	073961	Wheel 4x2.88x2.047x0.59
632-031	073961	Wheel 4x2.88x2.047x0.59
632-031/669	310103	Wheel 4x2.63x2.44x0.77
632-031-001	073961	Wheel 4x2.88x2.047x0.59
632-031-003	073961	Wheel 4x2.88x2.047x0.59

OE Number	Crown Base Part No.	Description
632-031-008	073961	Wheel 4x2.88x2.047x0.59
632-031-01	073961	Wheel 4x2.88x2.047x0.59
632-032	310158	Wheel 4x3.62x2.047x0.59
632-032/101	310158	Wheel 4x3.62x2.047x0.59
632-041/101	310168	Wheel 5x1.12x2.047xNon Typical
632-042	310159	Wheel 5x2x2.047x0.59
632-042/101	310159	Wheel 5x2x2.047x0.59
632-043	310164	Wheel 5x2.88x2.047x0.59
632-045	310173	Wheel 5x2x2.44xNon Typical
632-050	310164	Wheel 5x2.88x2.047x0.59
632-052	310160	Wheel 5x3.63x2.44x0.668
632-053	310161	Wheel 6x2.5x2.327x1.967
632-057	310169	Wheel 6x4x2.835x0.668
632-061	310177	Wheel 6x3x2.047x0.67
632-061-007	310177	Wheel 6x3x2.047x0.67
632-062	310167	Wheel 6x3x2.44x0.68
632-064	310166	Wheel 6x2.5x1.938x0.937
632-066	310163	Wheel 6.88x2x2.835x0.97
632-069	310178	Wheel 3.25x5.91x2.047x1.18
632-071	310180	Wheel 3.25x4.2x2.047x1.18
632-072	310219	Wheel 3.25x4.2x2.047x.590
632-076	154840	Wheel 3.25x2x2.047x0.59
632-078	310179	Wheel 8x4x2.44x0.656
632-081	310005	Tire Poly 9x3.5x6.5
632-085	107933	Tire Poly 10x5x6.5 Contour
632-087	310008	Tire Poly 10x3.5x8
632-090	107933	Tire Poly 10x5x6.5 Contour
632-090/03	310202	Tire Poly 10x5x6.5 w/Bevel
632-090/SPCL	310202	Tire Poly 10x5x6.5 w/Bevel
632-090-03	310012	Tire Poly 10x5x6.5
632-090-SPCL	310202	Tire Poly 10x5x6.5 w/Bevel
632-091	310011	Tire Poly 10x4.75x6.5 Contour
632-094	310017	Tire Poly 10.5x3.5x8
632-095	310020	Tire Poly 10.5x5x6.5
632-096	310018	Tire Poly 10.5x4.5x8
632-098	310023	Tire Poly 10.5x6.5x8
632-099	310015	Tire Poly 10x7x6.25
632-101	310020	Tire Poly 10.5x5x6.5 Sipe w CG
632-101/BA	310020	Tire Poly 10.5x5x6.5
632-102	310016	Tire Poly 10x7x8
632-104	310029	Tire Poly 12x5x9
632-106	310013	Tire Poly 10x6x6.25
632-108	310034	Tire Poly 13x6x10.5
632-112	077050	Tire Poly 13.5x5.5x8 Contour
632-114	310055	Tire Poly 15x7x11.25
632-115	310056	Tire Poly 15x8x11.125 G
632-119	310066	Tire Poly 16.25x7x11.25
632-120	310065	Tire Poly 16.25x6x11.25
632-121	310052	Tire Poly 15x6x11.25
632-122	310056	Tire Poly 15x8x11.125 G
632-123	310066	Tire Poly 16.25x7x11.25
632-125	310044	Tire Poly 14x5x11.25
632-126	310046	Tire Poly 14x6x11.25
632-126/962	310046	Tire Poly 14x6x11.25
632-129	310047	Tire Poly 14x8x11.25
632-131	310037	Tire Poly 13.5x6x10.5
632-132	310054	Tire Poly 15x6x11.75
632-133	079266	Tire Poly 13x5.5x8
632-134-CR1	079494	Tire Poly 13x4.5x8
632-135	310027	Tire Poly 12x5x8
632-139	310271	Tire Poly 14x8x10.25
632-141	310065	Tire Poly 16.25x6x11.25
632-145	310463	Tire Poly 15x6.5x10.75
632-145/015	310463	Tire Poly 15x6.5x10.75
632-146	310005	Tire Poly 9x3.5x6.5
632-147	310011	Tire Poly 10x4.75x6.5 Contour
632-151	310463	Tire Poly 15x6.5x10.75
632-153	310054	Tire Poly 15x6x11.75
632-154	310047	Tire Poly 14x8x11.25

Note: Add the compound part number to the base number listed above. Wheel compounds listed on page 11.03 (Format: XXXXXX-XXX.) and tire compounds and treads listed on page 11.19 (Format: XXXXX-XXX-XX).

Raymond Continued ▶

Wheel & Tire Cross References

Continued ▶

Raymond Continued

OE Number	Crown Base Part No.	Description
632-156	310172	Wheel 6x3.63x2.44x0.668
632-157	310175	Wheel 3.25x5.91x2.047x0.590
632-159	310066	Tire Poly 16.25x7x11.25
632-161	310064	Tire Poly 16.25x5x11.25
632-161/CA	310064	Tire Poly 16.25x5x11.25
632-163	310293	Tire Poly 9x7x6.25
632-163/015	310293	Tire Poly 9x7x6.25
632-163-015	310293	Tire Poly 9x7x6.25
632-165	310220	Wheel 3.25x1.75x1.850x.551
632-168	310011	Tire Poly 10x4.75x6.5 Contour
632-169	310011	Tire Poly 10x4.75x6.5 Contour
632-170	310011	Tire Poly 10x4.75x6.5 Contour
632-171	310011	Tire Poly 10x4.75x6.5 Contour
632-204	077084	Wheel 3.25x3.25x2.047x0.59
632-204/CR1	077084	Wheel 3.25x3.25x2.047x0.59
632-241	083179	Wheel 4x2.50x2.047x0.59
632-258	310101	Wheel 3.38x2.63x1.979x1.242
632-258-CL1	310101	Wheel 3.38x2.63x1.979x1.242
632-278	075999	Wheel
632-314	310141	Wheel 3.25x3x2.047x0.812
632-314	310174	Wheel 3.25x4x1.85x0.551
632-314/BA	310141	Wheel 3.25x3x2.047x0.812
632-314/MT	310174	Wheel 3.25x4x1.85x0.551
632-314MT	310174	Wheel 3.25x4x1.85x0.551
632-321	100462	Wheel 3.25x6.5x2.047x1.44
632-321/CR	100462	Wheel 3.25x6.5x2.047x1.44
632-322	310112	Wheel 3.38x2.63x2.047x1.137
632-322/CL1	310112	Wheel 3.38x2.63x2.047x1.137
632-41	082020	Wheel 6x4.25x3.149x0.83
632-414	082020	Wheel 6x4.25x3.149x0.83
632-421	083179	Wheel 4x2.50x2.047x0.59
632-421/CR	083179	Wheel 4x2.50x2.047x0.59
632421CR1	083179	Wheel 4x2.50x2.047x0.59
632-421-CR7	083179	Wheel 4x2.50x2.047x0.59
632-541	083587	Wheel 5x4.12x3.149x0.98
632-541/CR	083587	Wheel 5x4.12x3.149x0.98
632-623	082021	Wheel 6x2.75x3.149x0.83
632-623/CR1	082021	Wheel 6x2.75x3.149x0.83
632-637	310171	Wheel 6x3x1.781x0.81
632-812	132359	Wheel Caster
632-812	310131	Wheel 8.5x2.66x2.754xNon Typical
632-955/CR1	310208	Tire Poly 9x5x5 Smooth Step
632-955-CR1	077848	Tire Poly 9x5x5
640-051	073961	Wheel 4x2.88x2.047x0.59
640-070	310164	Wheel 5x2.88x2.047x0.59
671-013	083179	Wheel 4x2.50x2.047x0.59
671-015-21	083179	Wheel 4x2.50x2.047x0.59
671-024	310221	Wheel 4x1.92x1.781x.84
671-024/25	310221	Wheel 4x1.92x1.781x.84
671-026/020	310094	Wheel 4x2x1.575x0.575
671-026-20	310094	Wheel 4x2x1.575x0.575
671-041	310189	Wheel 3x3.5x1.85x0.56
671-041-07	310189	Wheel 3x3.5x1.85x0.56
671-053	310166	Wheel 6x2.5x1.938x0.937
671-421	083179	Wheel 4x2.50x2.047x0.59
921-000-370	310175	Wheel 3.25x5.91x2.047x0.590
928-603	310164	Wheel 5x2.88x2.047x0.59
939-353-251	310244	Wheel 3.25x4.5x2.047x.594
950-WHL/CENTER	310250	Wheel 3.25x1.88x2.047x0.595 I
950-WHL/ KIT	310250	Wheel Kit 3.25x1.88x2.047x0.595
950-WHL/ OUTER	310250	Wheel 3.25x1.88x2.047x0.595 O
D524334	310005	Tire Poly 9x3.5x6.5
M0203	073961	Wheel 4x2.88x2.047x0.59
RADS226864	310175	Wheel 3.25x5.91x2.047x0.590
S132	310180	Wheel 3.25x4.2x2.047x1.18
S158	310034	Tire Poly 13x6x10.5
S182	310056	Tire Poly 15x8x11.125 G
S621	310219	Wheel 3.25x4.2x2.047x.590
S623	310220	Wheel 3.25x1.75x1.850x.551

OE Number	Crown Base Part No.	Description
S626	310078	Wheel 3.25x2.88x2.047x0.59
S627	154840	Wheel 3.25x2x2.047x0.59
S628	310144	Wheel 3.25x6x2.047x0.812
S629	310178	Wheel 3.25x5.91x2.047x1.18
S632	310176	Wheel 4x2x2.44xNon Typical
S633	310157	Wheel 3.25x2.88x1.85x0.551
S635	310144	Wheel 3.25x6x2.047x0.812
S636	077086	Wheel 3.25x5x2.047x0.59
S640	310221	Wheel 4x1.92x1.781x.84
S645	310158	Wheel 4x3.62x2.047x0.59
S647	310099	Wheel 4x2.75x2.047x0.59
S648	310094	Wheel 4x2x1.575x0.575
S650	310159	Wheel 5x2x2.047x0.59
S651	310173	Wheel 5x2x2.44xNon Typical
S653	310164	Wheel 5x2.88x2.047x0.59
S654	310160	Wheel 5x3.63x2.44x0.668
S656	310168	Wheel 5x1.12x2.047xNon Typical
S663	310161	Wheel 6x2.5x2.327x1.967
S664	310167	Wheel 6x3x2.44x0.68
S666	310169	Wheel 6x4x2.835x0.668
S667	310166	Wheel 6x2.5x1.938x0.937
S671	310163	Wheel 6.88x2x2.835x0.97
S673	310172	Wheel 6x3.63x2.44x0.668
S674	310172	Wheel 6x3.63x2.44x0.668
S675	310177	Wheel 6x3x2.047x0.67
S684	310179	Wheel 8x4x2.44x0.656
S699	310177	Wheel 6x3x2.047x0.67
S700	310178	Wheel 3.25x5.91x2.047x1.18
RoL-Lift (RL)		
101	310188	Wheel 3.25x3.75x1.75xThru
9330	310188	Wheel 3.25x3.75x1.75xThru
9380	310089	Wheel 8x2x1.75xThru
913393	310089	Wheel 8x2x1.75xThru
3-91002	310089	Wheel 8x2x1.75xThru
3-91023	310188	Wheel 3.25x3.75x1.75xThru
R0301	310089	Wheel 8x2x1.75xThru
S9330	310188	Wheel 3.25x3.75x1.75xThru
S9380	310089	Wheel 8x2x1.75xThru
T-23-A	310089	Wheel 8x2x1.75xThru
T-42A	310188	Wheel 3.25x3.75x1.75xThru
Schreck (SC)		
41-27083	073961	Wheel 4x2.88x2.047x0.59
Still (SL)		
5402294	082285	Wheel (Nylon)
Toyota (TY)		
636	310078	Wheel 3.25x2.88x2.047x0.59
700	310178	Wheel 3.25x5.91x2.047x1.18
9143	083179	Wheel 4x2.50x2.047x0.59
9811	077086	Wheel 3.25x5x2.047x0.59
310225	310225	Wheel 6x3x1.9687
5900281871	310172	Wheel 6x3.63x2.44x0.668
00590-00013-71	310178	Wheel 3.25x5.91x2.047x1.18
00590-00023-71	310178	Wheel 3.25x5.91x2.047x1.18
00590-00025-71	310178	Wheel 3.25x5.91x2.047x1.18
00590-00506-71	310078	Wheel 3.25x2.88x2.047x0.59
00590-00773-71	077086	Wheel 3.25x5x2.047x0.59
00590-00777-71	077086	Wheel 3.25x5x2.047x0.59
00590-00779-71	077086	Wheel 3.25x5x2.047x0.59
00590-02818-71	310172	Wheel 6x3.63x2.44x0.668
00590-04775-71	083179	Wheel 4x2.50x2.047x0.59
00590-04780-71	083179	Wheel 4x2.50x2.047x0.59
00590-05044-71	310102	Wheel 5x3.62x2.834x0.76
00590-05047-71	310235	Wheel 4x2.88x2.44x0.672
00590-40028-71	310053	Tire Poly 13.5x5.5x10
00590-40031-71	310053	Tire Poly 13.5x5.5x10
00590-41747-71	310225	Wheel 6x3x1.9687
00590-41998-71	310225	Wheel 6x3x1.9687
00590-42111-71	310178	Wheel 3.25x5.91x2.047x1.18
00590-43383-71	310244	Wheel 3.25x4.5x2.047x.594

WHEELS AND TIRES

Note: Add the compound part number to the base number listed above. Wheel compounds listed on page 11.03 (Format: XXXXX-XXX) and tire compounds and treads listed on page 11.19 (Format: XXXXX-XXX-XX).

Toyota Continued ▶

Toyota Continued

OE Number	Crown Base Part No.	Description
00590-46419-71	310244	Wheel 3.25x4.5x2.047x.594
00590-46420-71	310244	Wheel 3.25x4.5x2.047x.594
00590-46421-71	310244	Wheel 3.25x4.5x2.047x.594
00591-04635-81	071665	Wheel Polyurethane
00591-04638-81	071894	Wheel 4 Poly
00591-04647-81	073602	Wheel 5 Steel Assm
00591-04828-81	080915	Wheel 8x3.75x3.15x0.83
00591-04838-81	081645	Wheel Poly
00591-04841-81	082020	Wheel 6x4.25x3.149x0.83
00591-04842-81	082021	Wheel 6x2.75x3.149x0.83
00591-04848-81	083879	Roller Load
00591-04849-81	083879	Roller Load
00591-04852-81	082443	Wheel 2.50x2.06x1.187
00591-04885-81	083585	Wheel 4x2.88x2.047x0.75
00591-04886-81	083586	Wheel 5x2.88x3.149x0.98
00591-04887-81	083587	Wheel 5x4.12x3.149x0.98
00591-04897-81	083834	Wheel
00591-05016-81	310131	Wheel 8.5x2.66x2.754xNon Typical
00591-10209-81	310249	Wheel 5.5x5x2.5
00591-10318-81	073602	Wheel 5 Steel Assm
00591-10322-81	075999	Wheel
00591-10325-81	077084	Load Wheel Assm 3.25x3.25
00591-10326-81	125069	Wheel 6x2.88x3.15x0.80
00591-10330-81	311520	Wheel 10x3 Caster
00591-10332-81	077084	Load Wheel Assm 3.25x3.25
00591-10341-81	083585	Wheel 4x2.88x2.047x0.75
00591-10342-81	088628	Wheel 4x4.12x2.047x0.75
00591-10343-81	088628	Wheel 4x4.12x2.047x0.75
00591-10362-81	077086	Wheel 3.25x5x2.047x0.59
00591-20043-81	044506-101	Roller Poly Assm
00591-21783-81	044507	Roller Poly
00591-21851-81	107933	Tire Poly 10x5x6.5 Contour
00591-25893-81	310108	Wheel 4x1.88x2.44x0.75
00591-26006-81	310093	Wheel 3.25x6.5x1.98x1.177
00591-26068-81	072718	Wheel Assm Poly
00591-26070-81	071892	Wheel 5 dia
00591-26079-81	115032	Wheel 5x2.88x2.44x0.83
00591-26080-81	115032	Wheel 5x2.88x2.44x0.83
00591-26085-81	083167	Wheel Rubber Assm
00591-30917-81	310093	Wheel 3.25x6.5x1.98x1.177
00591-31561-81	082274	Wheel Assm
00591-31569-81	082283	Wheel Assm (Poly)
00591-31841-81	073961	Wheel 4x2.88x2.047x0.59
00591-31851-81	071894	Wheel 4 Poly
00591-31852-81	073602	Wheel 5 Steel Assm
00591-31853-81	075999	Wheel
00591-31854-81	082021	Wheel 6x2.75x3.149x0.83
00591-31855-81	310131	Wheel 8.5x2.66x2.754xNon Typical
00591-31856-81	083879	Roller Load
00591-31858-81	077086	Wheel 3.25x5x2.047x0.59
00591-31859-81	100462	Wheel 3.25x6.5x2.047x1.44
00591-31861-81	083179	Wheel 4x2.50x2.047x0.59
00591-31862-81	081645	Wheel Poly
00591-31863-81	083585	Wheel 4x2.88x2.047x0.75
00591-31864-81	083587	Wheel 5x4.12x3.149x0.98
00591-31865-81	083586	Wheel 5x2.88x3.149x0.98
00591-31866-81	041269	Wheel Poly
00591-31874-81	083179	Wheel 4x2.50x2.047x0.59
00591-36575-81	077086	Wheel 3.25x5x2.047x0.59
00591-39562-81	082285	Wheel (Nylon)
00591-39612-81	044508	Roller Nylon
00591-39613-81	044506-102	Roller Nylon Assm
00591-39618-81	044506-101	Roller Poly Assm
00591-39626-81	044507	Roller Poly
00591-39628-81	044495	Wheel Assm Poly
00591-40742-81	072718	Wheel Assm Poly
00591-40744-81	071892	Wheel 5 dia
00591-40745-81	071665	Wheel Polyurethane
00591-40746-81	082443	Wheel 2.50x2.06x1.187

OE Number	Crown Base Part No.	Description
00591-40747-81	080915	Wheel 8x3.75x3.15x0.83
00591-40748-81	082020	Wheel 6x4.25x3.149x0.83
00591-40752-81	088628	Wheel 4x4.12x2.047x0.75
00591-40753-81	083167	Wheel Rubber Assm
00591-40771-81	073961	Wheel 4x2.88x2.047x0.59
00591-43114-81	044506-101	Roller Poly Assm
00591-43136-81	044495	Wheel Assm Poly
00591-43153-81	082285	Wheel (Nylon)
00591-43213-81	044506-102	Roller Nylon Assm
00591-43276-81	044508	Roller Nylon
00591-44880-81	044507	Roller Poly
00591-44881-81	115032	Wheel 5x2.88x2.44x0.83
00591-44882-81	115033	Wheel 5x4.12x2.44x0.83
00591-52026-81	082443	Wheel 2.50x2.06x1.187
00591-52028-81	075999	Wheel
00591-52035-81	077086	Wheel 3.25x5x2.047x0.59
00591-52037-81	083879	Roller Load
00591-52038-81	071665	Wheel Polyurethane
00591-52040-81	077086	Wheel 3.25x5x2.047x0.59
00591-52046-81	100462	Wheel 3.25x6.5x2.047x1.44
00591-52050-81	081645	Wheel Poly
00591-52052-81	071894	Wheel 4 Poly
00591-52053-81	083179	Wheel 4x2.50x2.047x0.59
00591-52059-81	071892	Wheel 5 dia
00591-52062-81	083586	Wheel 5x2.88x3.149x0.98
00591-52068-81	083587	Wheel 5x4.12x3.149x0.98
00591-52072-81	082021	Wheel 6x2.75x3.149x0.83
00591-52080-81	082020	Wheel 6x4.25x3.149x0.83
00591-52089-81	080915	Wheel 8x3.75x3.15x0.83
00591-52093-81	041269	Wheel Poly
00591-52099-81	083879	Roller Load
00591-52108-81	073961	Wheel 4x2.88x2.047x0.59
00591-52115-81	310131	Wheel 8.5x2.66x2.754xNon Typical
00591-52125-81	107933	Tire Poly 10x5x6.5 Contour
00591-52540-81	082274	Wheel Assm
00591-57656-81	044508	Roller Nylon
00591-57662-81	044506-101	Roller Poly Assm
00591-57673-81	044506-102	Roller Nylon Assm
00591-57678-81	044507	Roller Poly
00591-57680-81	044495	Wheel Assm Poly
00591-57793-81	072718	Wheel Assm Poly
00591-57811-81	077086	Wheel 3.25x5x2.047x0.59
00591-57827-81	088628	Wheel 4x4.12x2.047x0.75
00591-57829-81	073602	Wheel 5 Steel Assm
00591-57861-81	310179	Wheel 8x4x2.44x0.656
00591-57865-81	310093	Wheel 3.25x6.5x1.98x1.177
00591-57886-81	077086	Wheel 3.25x5x2.047x0.59
00591-57903-81	083167	Wheel Rubber Assm
00591-62172-81	310275	Caster Assembly FS STR4001
00591-71713-81	082021	Load Wheel Assm 6x2.75
00591-73835-81	123603	Load Wheel Assm 3.25 x 4.50
00591-74086-81	077084	Load Wheel Assm 3.25x3.25
590-00025-71	310178	Wheel 3.25x5.91x2.047x1.18
590-001086-71	310011	Tire Poly 10x4.75x6.5 Contour
590-04-006-71	310053	Tire Poly 13.5x5.5x10
590-04-148-71	310053	Tire Poly 13.5x5.5x10
S353	310102	Wheel 5x3.62x2.834x0.76
S700	310178	Wheel 3.25x5.91x2.047x1.18
S9143	083179	Wheel 4x2.50x2.047x0.59
Yale (YT)		
108	310174	Wheel 3.25x4x1.85x0.551
117	310185	Wheel 3.25x4.5x1.575x0.56
118	310170	Wheel 3.38x2.75x2.047x0.91
118	310184	Wheel 3.38x2.75x2.047x0.605
121	154840	Wheel 3.25x2x2.047x0.59
129	310187	Wheel 3.25x5.75x2.44x0.69
130	310138	Wheel 3.25x5.75x2.047x0.825
133	310093	Wheel 3.25x6.5x1.98x1.177
137	310184	Wheel 3.38x2.75x2.047x0.605

Note: Add the compound part number to the base number listed above. Wheel compounds listed on page 11.03 (Format: XXXXX-XXX.) and tire compounds and treads listed on page 11.19 (Format: XXXXX-XXX-XX).

Yale Continued ▶

Yale Continued

OE Number	Crown Base Part No.	Description
138	154840	Wheel 3.25x2x2.047x0.59
143	310183	Wheel 4x2.75x2.44x0.843
153	312360	Wheel 5x3.88x2.05x0.60
209	310235	Wheel 4x2.88x2.44x0.672
210	310183	Wheel 4x2.75x2.44x0.843
211	310186	Wheel 4x2.37x1.938x0.96
234	310193	Wheel 4x2.75x1.78x0.72
301	310089	Wheel 8x2x1.75xThru
338	310101	Wheel 3.38x2.63x1.979x1.242
354	310116	Wheel 5x3.75x2.834x0.74
386	310091	Wheel 7.88x2.48x2.047xNon Typical
425	310137	Wheel 3.25x4.28x2.047x0.825
606	310091	Wheel 7.88x2.48x2.047xNon Typical
641	073961	Wheel 4x2.88x2.047x0.59
647	310094	Wheel 4x2x1.575x0.575
653	310164	Wheel 5x2.88x2.047x0.59
663	310161	Wheel 6x2.5x2.327x1.967
801	310138	Wheel 3.25x5.75x2.047x0.825
805	310185	Wheel 3.25x4.5x1.575x0.56
806	310245	Wheel 3.25x4.5x2.047x.710
815	310093	Wheel 3.25x6.5x1.98x1.177
816	310000	Wheel 3.25x6.5 Single Bearing
817	100462	Wheel 3.25x6.5x2.047x1.44
820	310185	Wheel 3.25x4.5x1.575x0.56
821	310187	Wheel 3.25x5.75x2.44x0.69
824	310186	Wheel 4x2.37x1.938x0.96
826	310103	Wheel 4x2.63x2.44x0.77
827	310149	Wheel 3.25x3x2.047x0.656
828	083179	Wheel 4x2.50x2.047x0.59
828	310114	Wheel 4x2.5x2.047x0.76
844	310235	Wheel 4x2.88x2.44x0.672
5581	154840	Wheel 3.25x2x2.047x0.59
8313	310116	Wheel 5x3.75x2.834x0.74
9110	310078	Wheel 3.25x2.88x2.047x0.59
9143	083179	Wheel 4x2.50x2.047x0.59
9145	081645	Wheel Poly
9330	310188	Wheel 3.25x3.75x1.75xThru
9380	310089	Wheel 8x2x1.75xThru
9534	310174	Wheel 3.25x4x1.85x0.551
11493	081645	Wheel Poly
156181	310093	Wheel 3.25x6.5x1.98x1.177
188457	310096	Wheel 6x2x2.44x0.625
301314	083585	Wheel 4x2.88x2.047x0.75
310530	310078	Wheel 3.25x2.88x2.047x0.59
325993	310174	Wheel 3.25x4x1.85x0.551
560524	310174	Wheel 3.25x4x1.85x0.551
569987	310149	Wheel 3.25x3x2.047x0.656
569987	310212	Wheel 3.25x3x2.047x.590
598215	310142	Wheel 4x2.88x2.44x0.75
598215	310235	Wheel 4x2.88x2.44x0.672
650546	310185	Wheel 3.25x4.5x1.575x0.56
1213591	310170	Wheel 3.38x2.75x2.047x0.91
1219933	310002	Tire Poly 8x4x6.25
1291933	310002	Tire Poly 8x4x6.25
3032897	310178	Wheel 3.25x5.91x2.047x1.18
3051525	310093	Wheel 3.25x6.5x1.98x1.177
3133017	310181	Wheel 4x2.88x2.44x0.832
5748215	310142	Wheel 4x2.88x2.44x0.75
5748215	310235	Wheel 4x2.88x2.44x0.672
5800091	132359	Wheel Caster
5932569	310101	Wheel 3.38x2.63x1.979x1.242
6057853	310184	Wheel 3.38x2.75x2.047x0.605
65269600	310185	Wheel 3.25x4.5x1.575x0.56
65269601	310185	Wheel 3.25x4.5x1.575x0.56
15162900	310096	Wheel 6x2x2.44x0.625
19069600	310096	Wheel 6x2x2.44x0.625
25404500	310096	Wheel 6x2x2.44x0.625
57482700	310142	Wheel 4x2.88x2.44x0.75
57482700	310235	Wheel 4x2.88x2.44x0.672

OE Number	Crown Base Part No.	Description
65509200	310185	Wheel 3.25x4.5x1.575x0.56
120564301	310183	Wheel 4x2.75x2.44x0.843
121359100	310170	Wheel 3.38x2.75x2.047x0.91
129661100	154840	Wheel 3.25x2x2.047x0.59
129887100	154840	Wheel 3.25x2x2.047x0.59
150015306	310193	Wheel 4x2.75x1.78x0.72
150015364	077086	Wheel 3.25x5x2.047x0.59
150015365	077086	Wheel 3.25x5x2.047x0.59
150015428	310179	Wheel 8x4x2.44x0.656
150015437	073961	Wheel 4x2.88x2.047x0.59
150015450	310161	Wheel 6x2.5x2.327x1.967
150015505	073961	Wheel 4x2.88x2.047x0.59
150015527	072718	Wheel Assm Poly
150015529	073602	Wheel 5 Steel Assm
150015530	073961	Wheel 4x2.88x2.047x0.59
150015531	071892	Wheel 5 dia
150015533	071665	Wheel Polyurethane
150015536	075999	Wheel
150015537	082021	Wheel 6x2.75x3.149x0.83
150015538	082443	Wheel 2.50x2.06x1.187
150015543	082020	Wheel 6x4.25x3.149x0.83
150015546	083879	Roller Load
150015549	077086	Wheel 3.25x5x2.047x0.59
150015550	100462	Wheel 3.25x6.5x2.047x1.44
150015552	083879	Roller Load
150015554	071665	Wheel Polyurethane
150015555	100462	Wheel 3.25x6.5x2.047x1.44
150015556	081645	Wheel Poly
150015557	083179	Wheel 4x2.50x2.047x0.59
150015558	081645	Wheel Poly
150015559	083585	Wheel 4x2.88x2.047x0.75
150015562	083587	Wheel 5x4.12x3.149x0.98
150015563	083586	Wheel 5x2.88x3.149x0.98
150015568	083879	Roller Load
150017803	107933	Tire Poly 10x5x6.5 Contour
150017805	107933	Tire Poly 10x5x6.5 Contour
150102610	107933	Tire Poly 10x5x6.5 Contour
150103694	310028	Tire Poly 12x5.5x8
150110002	310002	Tire Poly 8x4x6.25
150110132	310040	Tire Poly 13.5x6.5x8
150110144	107933	Tire Poly 10x5x6.5 Contour
150110192	077848	Tire Poly 9x5x5
150110322	107933	Tire Poly 10x5x6.5 Contour
150110663	310028	Tire Poly 12x5.5x8
150110666	107933	Tire Poly 10x5x6.5 Contour
150110683	107933	Tire Poly 10x5x6.5 Contour
155015398	310144	Wheel 3.25x6x2.047x0.812
220002190	310131	Wheel 8.5x2.66x2.754xNon Typical
220007770	083879	Roller Load
220007781	072718	Wheel Assm Poly
220007782	073602	Wheel 5 Steel Assm
220008327	073961	Wheel 4x2.88x2.047x0.59
220008610	083586	Wheel 5x2.88x3.149x0.98
220008615	100462	Wheel 3.25x6.5x2.047x1.44
220008657	071894	Wheel 4 Poly
220008659	075999	Wheel
220008660	082021	Wheel 6x2.75x3.149x0.83
220008661	082443	Wheel 2.50x2.06x1.187
220008662	080915	Wheel 8x3.75x3.15x0.83
220008663	082020	Wheel 6x4.25x3.149x0.83
220008666	083179	Wheel 4x2.50x2.047x0.59
220008667	081645	Wheel Poly
220008668	083585	Wheel 4x2.88x2.047x0.75
220008669	083587	Wheel 5x4.12x3.149x0.98
220012781	073961	Wheel 4x2.88x2.047x0.59
220012897	071892	Wheel 5 dia
220013557	132359	Wheel Caster
220013668	041269	Wheel Poly
220015006	115032	Wheel 5x2.88x2.44x0.83

WHEELS AND TIRES

Note: Add the compound part number to the base number listed above. Wheel compounds listed on page 11.03 (Format: XXXXX-XXX) and tire compounds and treads listed on page 11.19 (Format: XXXXX-XXX-XX).

Yale Continued ▶

Wheel & Tire Cross References

Continued ▶

Yale Continued

OE Number	Crown Base Part No.	Description
220015019	115033	Wheel 5x4.12x2.44x0.83
220015044	100462	Wheel 3.25x6.5x2.047x1.44
220015049	088628	Wheel 4x4.12x2.047x0.75
220015058	082021	Wheel 6x2.75x3.149x0.83
220015616	073961	Wheel 4x2.88x2.047x0.59
220016967	082021	Wheel 6x2.75x3.149x0.83
220016976	077084	Wheel 3.25x3.25x2.047x0.59
220017453	082285	Wheel (Nylon)
220020717	082283	Wheel Assm (Poly)
220021096	081520	Wheel Caster Assm 10 x 3
220022590	073961	Wheel 4x2.88x2.047x0.59
220023602	083179	Wheel 4x2.50x2.047x0.59
220024613	115033	Wheel 5x4.12x2.44x0.83
220028022	077086	Wheel 3.25x5x2.047x0.59
220028358	083167	Wheel Rubber Assm
220034310	310131	Wheel 8.5x2.66x2.754xNon Typical
220043337	083179	Wheel 4x2.50x2.047x0.59
220044606	077086	Wheel 3.25x5x2.047x0.59
220052145	071665	Wheel Polyurethane
220052147	083879	Roller Load
500660501	310065	Tire Poly 16.25x6x11.25
500660502	310066	Tire Poly 16.25x7x11.25
500660503	310121	Tire Poly 21x8x15
500660506	310066	Tire Poly 16.25x7x11.25
500660507	310075	Tire Poly 22x8x16
500660511	310071	Tire Poly 18x8x12.125
500660512	310064	Tire Poly 16.25x5x11.25
500660513	310066	Tire Poly 16.25x7x11.25
500660514	310065	Tire Poly 16.25x6x11.25
500660516	310121	Tire Poly 21x8x15
500660519	310052	Tire Poly 15x6x11.25
500660521	310065	Tire Poly 16.25x6x11.25
500660522	310052	Tire Poly 15x6x11.25
500660523	310072	Tire Poly 18x9x12.125
500660524	310048	Tire Poly 15x5x11.25
501593000	310183	Wheel 4x2.75x2.44x0.843
501774915	107933	Tire Poly 10x5x6.5 Contour
501776932	079266	Tire Poly 13x5.5x8
501776904	077848	Tire Poly 9x5x5
501776927	310025	Tire Poly 12x4.5x8
501777904	310028	Tire Poly 12x5.5x8
501786902	310002	Tire Poly 8x4x6.25
501788915	107933	Tire Poly 10x5x6.5 Contour
502036002	107933	Tire Poly 10x5x6.5 Contour
503566503	310187	Wheel 3.25x5.75x2.44x0.69
504246501	310088	Wheel 3.38x2.75x2.047x0.812
504246502	310184	Wheel 3.38x2.75x2.047x0.605
504449731	310164	Wheel 5x2.88x2.047x0.59
504574233	310137	Wheel 3.25x4.28x2.047x0.825
504574280	073961	Wheel 4x2.88x2.047x0.59
504646501	310184	Wheel 3.38x2.75x2.047x0.605
504646505	310187	Wheel 3.25x5.75x2.44x0.69
504820503	310138	Wheel 3.25x5.75x2.047x0.825
504910501	310184	Wheel 3.38x2.75x2.047x0.605
504910502	310184	Wheel 3.38x2.75x2.047x0.605
504910503	310138	Wheel 3.25x5.75x2.047x0.825
504910505	310184	Wheel 3.38x2.75x2.047x0.605
504919500	310012	Tire Poly 10x5x6.5
504919501	310202	Tire Poly 10x5x6.5 w/Bevel
504919501	107933	Tire Poly 10x5x6.5 Contour
505596501	310093	Wheel 3.25x6.5x1.98x1.177
506626501	312360	Wheel 5x3.88x2.05x0.60
506626502	312360	Wheel 5x3.88x2.05x0.60
506788501	310164	Wheel 5x2.88x2.047x0.59
506788502	310164	Wheel 5x2.88x2.047x0.59
506788503	310164	Wheel 5x2.88x2.047x0.59
506790500	073961	Wheel 4x2.88x2.047x0.59
506790501	073961	Wheel 4x2.88x2.047x0.59
506790502	073961	Wheel 4x2.88x2.047x0.59

OE Number	Crown Base Part No.	Description
506790503	073961	Wheel 4x2.88x2.047x0.59
506837301	310096	Wheel 6x2x2.44x0.625
515732816	310089	Wheel 8x2x1.75xThru
515732830	310188	Wheel 3.25x3.75x1.75xThru
515732831	310188	Wheel 3.25x3.75x1.75xThru
516353810	310089	Wheel 8x2x1.75xThru
518782600	310094	Wheel 4x2x1.575x0.575
518822810	310186	Wheel 4x2.37x1.938x0.96
518822829	310186	Wheel 4x2.37x1.938x0.96
520318808	310094	Wheel 4x2x1.575x0.575
522572001	310093	Wheel 3.25x6.5x1.98x1.177
524140950	310240	Wheel 3.25x6.5 Single Bearing
524140951	310041	Wheel 3.25x6.5x2.047x1.681
524140951	100462	Wheel 3.25x6.5x2.047x1.44
524148457	083179	Wheel 4x2.50x2.047x0.59
524148750	310245	Wheel 3.25x4.5x2.047x.710
524149477	310025	Tire Poly 12x4.5x8
524150937	310298	Wheel 4x1.75x2.44x0.81
524196822	310234	Wheel 5x3.875x2.44x0.67
550023492	310245	Wheel 3.25x4.5x2.047x.710
580006428	310039	Tire Poly 13.5x5.5x8
580009181	310129	Wheel 8.5x2.69x2.754x2.5
580016713	083179	Wheel 4x2.50x2.047x0.59
580022365	073961	Wheel 4x2.88x2.047x0.59
580022366	310164	Wheel 5x2.88x2.047x0.59
580046742	310079	Wheel 5x2.875x2.44x0.67
580067769	310234-306-88▲	Wheel 5x3.875x2.44x.67 No Seal
580068147	310234-306-66▲	Wheel 5x3.875x2.44x.67 Sealed
580070396	310234	Wheel 5x3.875x2.44x0.67
590010047	310227	Wheel 7x2.75x1.98
60215440C	370355	Wheel Rubber 5.5x5x2.19
620982100	154840	Wheel 3.25x2x2.047x0.59
624148750	310136	Wheel 3.25x4.71x2.047x0.825
720465001	310183	Wheel 4x2.75x2.44x0.843
720465006	310183	Wheel 4x2.75x2.44x0.843
721743000	310183	Wheel 4x2.75x2.44x0.843
723227302	310198	Tire Poly 6x3x4
730320302	310133	Wheel 5x2.88x2.44x0.775
752739301	310142	Wheel 4x2.88x2.44x0.75
753009400	310025	Tire Poly 12x4.5x8
754442400	312360	Wheel 5x3.88x2.05x0.60
800017230	125070	Wheel 6x4.12x3.149x0.98
800017585	127723	Wheel Caster 8x4x2.83
800020380	077084	Load Wheel Assm 3.25x3.25
800020380	092537	Wheel Assm 3.25x3.25x2.047x0.59
800045244	083586	Wheel 5x2.88x3.149x0.98
800045250	310131	Wheel 8.5x2.66x2.754xNon Typical
800045277	125070	Wheel 6x4.12x3.149x0.98
800046166	073602	Wheel 5 Steel Assm
800046167	125069	Wheel 6x2.88x3.15x0.80
800050156	115032	Wheel 5x2.88x2.44x0.83
800076056	071894	Wheel 4 Poly
800076068	073602	Wheel 5 Steel Assm
800076205	082741	Wheel Nylon
800076404	082283	Wheel Assm (Poly)
800114768	072718	Wheel Assm Poly
800114775	071892	Wheel 5 dia
800114779	071665	Wheel Polyurethane
800114783	082021	Wheel 6x2.75x3.149x0.83
800114787	077084	Load Wheel Assm 3.25x3.25
800114787	092537	Wheel Assm 3.25x3.25x2.047x0.59
800114802	311520	Wheel 10x3 Caster
800114805	077084	Load Wheel Assm 3.25x3.25
800114805	092537	Wheel Assm 3.25x3.25x2.047x0.59
800114812	115033	Wheel 5x4.12x2.44x0.83
800114818	100462	Wheel 3.25x6.5x2.047x1.44
800114833	083179	Wheel 4x2.50x2.047x0.59
800114837	083585	Wheel 4x2.88x2.047x0.75

▲ WARNING: Cancer - www.P65Warnings.ca.gov

Note: Add the compound part number to the base number listed above. Wheel compounds listed on page 11.03 (Format: XXXXXX-XXX.) and tire compounds and treads listed on page 11.19 (Format: XXXXXX-XXX-XX).

Yale Continued ▶

Wheel & Tire Cross References

Yale Continued

OE Number	Crown Base Part No.	Description
800114838	083585	Wheel 4x2.88x2.047x0.75
800114845	088628	Wheel 4x4.12x2.047x0.75
800114846	088628	Wheel 4x4.12x2.047x0.75
800114851	083587	Wheel 5x4.12x3.149x0.98
800114853	083586	Wheel 5x2.88x3.149x0.98
800114856	115033	Wheel 5x4.12x2.44x0.83
800114858	115033	Wheel 5x4.12x2.44x0.83
800120656	123603	Wheel 3.25x4.50x2.16x0.52
800120802	115032	Wheel 5x2.88x2.44x0.83
800354576	310137	Wheel 3.25x4.28x2.047x0.825
6200613100	310184	Wheel 3.38x2.75x2.047x0.605
118P	310184	Wheel 3.38x2.75x2.047x0.605
12056430A	310183	Wheel 4x2.75x2.44x0.843
R0101	310188	Wheel 3.25x3.75x1.75xThru
S107	310174	Wheel 3.25x4x1.85x0.551
S124	310078	Wheel 3.25x2.88x2.047x0.59
S127	310188	Wheel 3.25x3.75x1.75xThru
S128	310188	Wheel 3.25x3.75x1.75xThru
S129	310185	Wheel 3.25x4.5x1.575x0.56
S130	310170	Wheel 3.38x2.75x2.047x0.91
S137	310184	Wheel 3.38x2.75x2.047x0.605
S138	154840	Wheel 3.25x2x2.047x0.59
S139	154840	Wheel 3.25x2x2.047x0.59
S143	310183	Wheel 4x2.75x2.44x0.843
S144	310187	Wheel 3.25x5.75x2.44x0.69
S149	310186	Wheel 4x2.37x1.938x0.96
S152	310186	Wheel 4x2.37x1.938x0.96
S153	312360	Wheel 5x3.88x2.05x0.60
S186	310089	Wheel 8x2x1.75xThru
S188	310091	Wheel 7.88x2.48x2.047xNon Typical
S230	310144	Wheel 3.25x6x2.047x0.812
S234	310193	Wheel 4x2.75x1.78x0.72
S420	154840	Wheel 3.25x2x2.047x0.59

OE Number	Crown Base Part No.	Description
S425	310137	Wheel 3.25x4.28x2.047x0.825
S441	310136	Wheel 3.25x4.71x2.047x0.825
S443	073961	Wheel 4x2.88x2.047x0.59
S446	310137	Wheel 3.25x4.28x2.047x0.825
S529	310144	Wheel 3.25x6x2.047x0.812
S542	310142	Wheel 4x2.88x2.44x0.75
S553	310133	Wheel 5x2.88x2.44x0.775
S553	310143	Wheel 5x2.88x2.44x0.75
S630	310185	Wheel 3.25x4.5x1.575x0.56
S653	310164	Wheel 5x2.88x2.047x0.59
S700	310178	Wheel 3.25x5.91x2.047x1.18
S819	310149	Wheel 3.25x3x2.047x0.656
S820	310185	Wheel 3.25x4.5x1.575x0.56
S821	310187	Wheel 3.25x5.75x2.44x0.69
S824	310186	Wheel 4x2.37x1.938x0.96
S825	310184	Wheel 3.38x2.75x2.047x0.605
S826	310103	Wheel 4x2.63x2.44x0.77
S827	310138	Wheel 3.25x5.75x2.047x0.825
S837	310174	Wheel 3.25x4x1.85x0.551
S844	310235	Wheel 4x2.88x2.44x0.672
S847	081645	Wheel Poly
S848	310116	Wheel 5x3.75x2.834x0.74
S850	310093	Wheel 3.25x6.5x1.98x1.177
S851	073961	Wheel 4x2.88x2.047x0.59
S857	310164	Wheel 5x2.88x2.047x0.59
S872	310198	Tire Poly 6x3x4
S888	310091	Wheel 7.88x2.48x2.047xNon Typical
S9143	083179	Wheel 4x2.50x2.047x0.59
S9330	310188	Wheel 3.25x3.75x1.75xThru
S9380	310089	Wheel 8x2x1.75xThru
S9534	310174	Wheel 3.25x4x1.85x0.551
S9811	077086	Wheel 3.25x5x2.047x0.59
S9842	310181	Wheel 4x2.88x2.44x0.832

Note: Add the compound part number to the base number listed above. Wheel compounds listed on page 11.03 (Format: XXXXXX-XXX.) and tire compounds and treads listed on page 11.19 (Format: XXXXX-XXX-XX).



A Crown Equipment Brand

Total Truck Power Solutions

Crown offers the resources and expert guidance to build a complete power system for your application:



- Lead-Acid and Lithium-Ion Batteries
- Industrial Battery Chargers
- Supplies and Accessories
- Power Study and Maintenance

See Section 8
For the Battery and Charger Section



Protect Products and Pallets

Pallet Dawg - Bull Dawg



Pallet Dawg Bull Dawg

- For high-impact and rigorous applications
- Easy installation with only a few simple parts
- Compatible with any Class II forklift carriage

Bull Dawg

- Two galvanized steel bars for heavy-duty environments
- For severe cold environments

See Section 7
InfoLink, PTH50, Chain, Forks and Attachment Parts

Crown Tool Program

Tools designed and built to get the job done!



The Crown tool program offers high quality tools selected specifically for technicians to handle most lift truck repairs. Each item offered is individually labeled with the Crown logo and the part number. Most tools include a lifetime warranty.



See the Tools section for the assortment of tools available.

Section 12

Crown Operator and Service Training

Contents

Operator Training Workshops	12.02
Operator Training Materials	12.03
Service Training Workshops	12.04
Supplemental Service Training Materials	12.05

New Items:

GPC Operator Training - p. 12.03
DualMode T Advanced Onboarding - p. 12.03
DualMode T Basic - p. 12.03
DualMode T Introduction to Guide Path - p. 12.03
InfoLink Training for Operators - p. 12.03
LeadSafe Supervisor Training - p. 12.03
Operator Training Trainer's Guide - p. 12.03
Pedestrian Safety - p. 12.03





Demonstrated Performance®

Operator Training

Operator Training Workshops

CROWN OPERATOR AND SERVICE TRAINING



DP MoveSafe® - Train-the-Operator

Crown's nationwide network of trained instructors offer full-service training programs. Conducted at your site, these highly trained instructor led sessions present the full gamut of powered industrial truck safety information with clear, understandable and highly visual video and animated presentations. Hands-on time is maximized and structured to assure your operators are trained not only in truck operation and task performance, but in safe operating habits and practices as well. These are crucial in the effective training of your operators.

Contact your local Crown lift truck dealer for available dates and pricing.

DP LeadSafe® - Train-the-Supervisor

Supervisors of lift truck operators play a critical role in reinforcing the safe operating skills and habits taught during operator training sessions. To help them do this, Crown offers the award winning* LeadSafe Program in a Demonstrated Performance format to help them learn and demonstrate how to effectively supervise lift truck operators and reinforce safe operating habits.

The training covers topics such as: Identifying Proper and Improper Operation, Recognizing Potential Hazards, and Giving Feedback to Operators.

Contact your local Crown lift truck dealer for pricing. Crown's Operator Training Programs are optimized for interactive streaming. The training can be hosted and tracked on Crown's Learning Management System (LMS) or utilized within your current Learning Management System (LMS). Each program has a step by step interface guiding the user through the training process.

DP TrainSafe® - Train-the-Trainer

DP TrainSafe uses Crown's award winning, hands-on, Demonstrated Performance approach to deliver the best and most comprehensive operator train-the-trainer program in the industry. Participants in the two day TrainSafe program will learn and practice implementing Crown's MoveSafe operator training programs, 11 step hands-on training and safe skill and habit development process. Trainers will leave with the training needed to conduct these workshops, as well as three year re-evaluations, safety refreshers (workshops), warehouse inspections, and much more.

DP TrainSafe is offered at most Crown dealers.

Contact your local Crown lift truck dealer for available dates and pricing.

Available Operator Training Materials listed on page 12.03

Visit Crown.com for more Training information and to locate your closest Crown dealer.

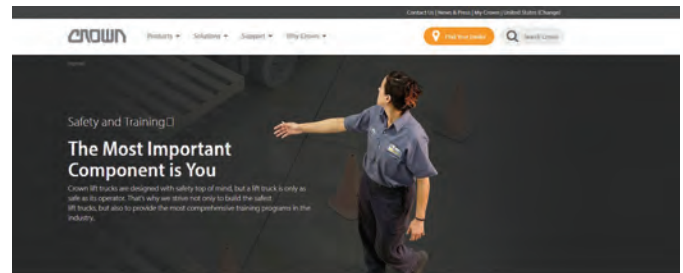

*2008 International Society for Performance Improvement Award of Excellence

To view information videos on DP TrainSafe®, DP MoveSafe® and DP LeadSafe®, go to:
<http://www.youtube.com/user/CrownEquipment>



Demonstrated Performance

Operator Training

Operator Training Materials



Crown offers the most comprehensive line of training tools to help maximize your resources for more effective Operator Training.

Crown's Operator Training Programs are optimized for interactive streaming. The training can be hosted and tracked on Crown's Learning Management System (LMS) or utilized within your current Learning Management System (LMS). Each program has a step by step interface guiding the user through the training process.

Note: All lift truck programs are available in English and Spanish, including the 11-step hands on training process.



Operator Training Programs

Program Name	LMS Module Name	LMS Number
It's Up to You (required with programs marked with † below)		
FC4000-4500 Series Four Wheel Sit-Down Trucks †	FC 4000-4500 Series Operator Training	200009
GPC Operator Training 	GPC Operator Training	200014
IC Class IV and V Combustion Trucks	Internal Combustion Class IV and V Operator Training	200016
M Series Rider Pallet Trucks †	M Series Walkie Stackers Operator Training	200135
MPC3000 Series Order Picker	MPC 3000 Operator Training	200069
PC4500 Series Rider Pallet Trucks	PC 4500 and Quick Pick Remote Advance Operator Training	200043
PE4000-4500 Series Pallet Trucks	PE 4000-4500 Operator Training	36002
PR3000-4500 Series Pallet Trucks †	PR 3000-4500 Series Operator Training	200021
PW3500 Series Walkie Pallet Trucks †	PW 3000-3500 Series Operator Training	200106
RC3000 Series Stand-Up Riders †	RC 3000 Series Operator Training	200142
RC5500 Series Stand-Up Riders	RC 5500 Operator Training	200111
RR/RD- RM/RMD 5000-600 Series Reach Trucks	RR/RM 5000-6000 Series Operator Training	200055
RT4000 Series Rider Pallet Trucks	RT 4000 Operator Training	200068
SC4000-4500 Series Three Wheel Sit-Down Trucks †	SC 4000-5000 Series Operator Training	200112
SH/SHR, ST/SX3000 and WE/WS2300 Series	SH/SHR, ST/SX, WE/WS2300 Series Operator Training	200027
SP3000-4000 Series Stockpickers	SP 3000-4000 Series Operator Training	200143
TR-TWR 3000-3600 Series Tow Tractors †	TWR/TR 3000-4500 Series Operator Training	200030
TSP6000-7000 Series Turret Sideloaders †	TSP 6000-7000 Series Operator Training	200059
Wave Work Assist Vehicle	Wave Operator Training	200062
WP2000 Series Waalkie Pallet Trucks †	WP 2300-3000 Series Operator Training	200125
DualMode T Advanced Onboarding	DP189005 DualMode T Advanced Onboarding	189005
DualMode T Basic	DP187007 DualMode T Basic	187007
DualMode T Introduction to Guide Path	DP187006 DualMode T Introduction to Guide Path	187006
InfoLink Training for Operators 	DP01539 InfoLink Training for Operators	1539
LeadSafe Supervisor Training	DP36700 LeadSafe Supervisor Training	36700
Operator Training Trainer's Guide	Operator Training Trainer's Guide	200087
Pedestrian Safety	Pedestrian Safety	43400

Trainer's and Supervisor's Tools

Program Name	Part Number
Notice of Completion Certificates (Package of 100)	SF12464
Trainer's Binder	SF12756-PRO
Trainer's Binder Kit - Contains Operator Training Resource USB	SF12756-KIT
Triennial Evaluation Program	SF18025-PRO
Safety Awareness Topics Program	SF18026-PRO
Triennial/Safety Topics Bundle	SF18322-PKG

Supervisor's Training

Program Name
LeadSafe Program Streaming Option Only

Pedestrian Training

Program Name
Pedestrian Safety Program

Operator Manuals

See your local Crown dealer or find part numbers at this link:
http://www.crown.com/usa/parts/lookup_tool.html

Stand-Up Safety

Program Name
Stand-Up Safety
Included in RC3000 & RR/RS/RD 3000/3500.



Demonstrated Performance[®]

Service Training

Service Training Workshops



CROWN OPERATOR AND SERVICE TRAINING

DP Service Training - For your Lift Truck Technicians

Our award winning* Demonstrated Performance service training workshops give your technicians the Crown-specific skills and knowledge they need to keep your Crown fleet up and running. Since many technicians are hands-on learners, they're more likely to retain information learned through first-hand experience than material presented in a lecture. Crown's Demonstrated Performance Service Technician Training goes above and beyond traditional classroom training, allowing participants to work on trucks with instructor supervision. Technicians can move at their own pace and focus on the particular tasks and skill groups that best serve their organization's needs.

**Learn It.
Do It.
Use It.[®]**

This defines the philosophy behind Crown DP training. Participants "Learn it" by reading the module, reviewing any reference material, and practicing the required skills. Then they "Do it" by performing what we call a "skill check" for the instructor to demonstrate their ability to perform the skill. This prepares them to bring their newly acquired skills back to their job and "Use it" to improve the uptime and reliability of Crown lift trucks.

Demonstrated Performance workshops are completely customizable to the needs of your technician. They'll only spend time on what they need to learn, and only work on the trucks that apply to them. For example, they won't spend two hours learning about basic electricity if they already know it. Before the DP training course spend some time talking to your technician about what you want them to cover during the session. Do you want them to focus on mechanical topics, such as repairing or replacing components? Or do you want them to learn how to troubleshoot the electrical system? Contact one of the following Regional Training Centers and the Regional Service Trainer to have a customized training course map developed to match your need.

DP Service Training is offered at the following Regional Training Centers. To schedule, email Education.center@crowncorp.com

- Atlanta, GA
- Franklin, MA
- Dallas, TX
- Dayton, OH
- Kansas City, KS
- Los Angeles, CA
- Schaumburg, IL
- Toledo, OH

*2006 International Society for Performance Improvement Award of Excellence



The programs listed below cover fundamental principles and systems that can apply to many truck models.

For Crown DP Service Training, contact one of Crown's Regional DP Service Training locations listed on the previous page.

Service Training Programs PM Training

Program Name	Part Number
RR/RD5000-5700 - PM	PF18983-PRO
PE4000-4500 - PM	PF18984-PRO
PR4000-4500 - PM	PF18985-PRO
SP3000-4000 - PM	PF18986-PRO
RC5500 - PM	PF18987-PRO
C5 - PM	PF19243-PRO
RM/RMD6000 Series - PM	PF19836-PRO

Legacy Programs

Program Name	Part Number
FC 4000 EV100	PF13437-PRO
RR 5000 Hydraulics	PF13044-PRO
RR 5000 Wiring Diagrams	PF13342-PRO
SC 4000 Series	PF12825-PRO
Basic Electricity, Hydraulics and Motor Theory	PF18660-102

Supplemental Service Training Materials



- Absorbent Products..... 1.13, 1.18-1.21, 2.17-2.18
Accelerator Unit..... 5.52
Accu-Tilt..... 6.16
Adhesives..... 1.24-1.25
Adhesive Eraser..... 1.15, 9.23
Aerosols..... 1.09-1.10
Air Filters..... 1.28-1.48
Air Pneumatic Tires..... 11.29
Aircraft Cable..... 4.19
Alarms..... 4.10, 7.04
Alternators..... 5.20-5.22
Antifreeze & Test Kit..... 1.05
Anti-Slip Floor Tape..... 3.06
Apron..... 2.13, 8.02, 8.51
Attachment Parts..... 7.12-7.20
Automotive Battery Connectors..... 8.46
Axles, Shafts & Pins...4.48-4.49, 4.53-4.55, 11.11-11.15
Back-Up Alarms..... 4.10
Back Support..... 2.07
Bags
Trash Can..... 1.21, 3.09
Battery Cell..... 8.51
Batteries..... 8.16-8.21
Battery
Acid Indicators..... 8.47
Battery Room Checklist..... 8.02
Battery Caps..... 8.41
Cable Assemblies..... 8.13-8.14, 8.39-8.40
Cable Mount..... 8.09
Cable Retractor..... 8.09
Capacity Indicator..... 4.31-4.32
Cell Bag..... 8.51
Connectors..... 8.41-8.45
Demo Watering Kit..... 8.26
Discharge Indicator..... 4.31-4.32, 4.48
Display Rack..... 8.19
Extractor, Strap & Hook..... 8.50, 9.05
Monitoring..... 8.08, 9.16
Posters..... 8.15
Spill Kit..... 2.18, 8.52
Strap..... 8.37
Tester..... 8.48, 9.16
Tools..... 8.36, 8.47-8.50
Watering..... 8.23-8.36
BDI..... 4.31-4.32
Bearings..... 4.33-4.35, 11.16-11.18
Belts
Fan..... 5.46-5.47
Seat..... 2.02, 5.09
Timing..... 4.55, 5.47
Bijax OEM Parts..... 3.20-3.21
Blackout Lens..... 4.06
Bollards..... 3.02
Borescope..... 9.08
Brackets..... 8.08
Brake
Adjuster..... 5.30
Cable..... 4.56, 5.30
Cylinders..... 5.33-5.34
Disc..... 4.56
Emergency Handle..... 5.29-5.30
Fluid..... 1.04
Pads..... 5.29
Pedal/Pedal Cover..... 5.29
Rotors..... 4.56
Shoes..... 5.26-5.28
Springs..... 5.28-5.29
Tail/Back-Up Lights..... 4.05
Tools..... 9.17
Breathing Protection..... 2.10
Brush
Motor..... 4.61-4.66
Spring..... 4.66-4.68
Bulbs..... 4.02
Bumpers..... 3.02
Bushings..... 4.33, 4.35, 4.42-4.44, 4.49, 4.54
Buttons..... 4.50, 4.52, 4.71, 4.73, 5.62
Cable
Aircraft..... 4.19
Cable..... 5.30
Camera..... 6.13-6.15
Control..... 4.19
Emergency Brake..... 5.30
Ends..... 8.46
Parking Brake..... 4.56, 5.30
Power..... 4.19, 8.46
Retractors, Battery..... 8.09
Ties..... 1.21, 8.46
Camera
Kits..... 6.15
Systems..... 6.13-6.14
Can Liners..... 1.21
Cap
Bouffant..... 2.13
Knit Cap with LED Light..... 2.13
Caps, Distributor..... 5.38-5.41
Car Stop..... 3.12
Carabiners..... 2.05, 2.06
Cards, Electronic..... 4.27-4.29
Cart..... 3.15, 9.05
Cascade Parts..... 7.13-7.16
Caster, Wheels..... 3.17, 4.45, 11.07-11.09
Chain..... 3.13, 7.07-7.08, 11.32
Chain Wear Gauge..... 7.08, 9.05
Charger Stands..... 8.06-8.07
Chargers..... 8.03-8.05
Checklist..... 8.02
Chemicals..... 1.24-1.27
Chocks, Wheel..... 3.12-3.13, 9.21
Cleaners..... 1.08-1.11, 1.13, 3.08, 8.51-8.52
Clutch Cover..... 5.54
Coils..... 5.42
Compressor Oil..... 1.03
Cones, Traffic..... 2.16
Connectors
Battery..... 8.41-8.45
Deutsch..... 4.11, 9.20
Connecting Link..... 5.60, 7.08
Contactor, Tips..... 4.26
Contactors..... 4.24-4.25
Control Cable..... 4.19
Control Cards..... 4.27-4.29
Converters
DC/DC..... 4.29
Propane..... 5.10
Torque..... 5.52
Coolant..... 1.05
Cooling Products..... 2.14
Cord, Replacement..... 3.23, 4.70, 8.11-8.12
Couplings..... 10.02-10.07
Cover
Clutch..... 5.54
Forklift..... 6.19
Hub..... 5.61
Water Pump..... 5.18-5.19
Coveralls..... 2.13
Crimping Tools..... 4.11, 8.42, 8.45, 8.49-8.50, 9.08-9.09, 9.16, 9.19-9.20
Cross References
Battery..... 8.20-8.21
Casters..... 11.09
Filters..... 1.28-1.48
Rightline Parts..... 7.18-7.20
Wheels & Tires..... 11.33-11.49
Cylinders..... 4.56, 4.69, 5.33-5.36
DC/DC Converters..... 4.29
De-icer..... 1.05
Deionizers..... 8.26
Demo Watering Kit..... 8.26
Diagnostic Tools..... 9.14-9.16
Diaphragm Kit..... 5.13
DIN Connectors..... 8.44-8.45
Dipstick..... 5.55
Disc Brakes..... 4.56
Disc Pads..... 9.23
Dispensers
Chemical..... 1.08, 1.13-1.14
Towel..... 1.20-1.21
Wipe..... 1.11
Disposable Clothing..... 2.12-2.13
Distributors & Caps..... 5.38-5.42
Dockboards..... 3.18
Dome Lights..... 4.05
Drive Motors..... 4.58-4.60
Drive Tools..... 9.13
Drive Train..... 5.52-5.54
Drive Unit/Parts..... 4.49-4.56
Drum, 55 Gallon..... 1.13
Durometer..... 9.05, 11.21
Ear Protection..... 2.09
Electrical Tools..... 9.18-9.20
Electronic Cards..... 4.27-4.29
Emergency Brake Handle..... 5.29-5.30
Emergency Brake Switch..... 4.72
Encoder..... 4.53
Ergonomic Products..... 2.07
Evacuator, Fluid..... 9.17
Exhaust Pipe..... 5.32
Expandable Sleeving..... 8.46
Extraction Tools..... 9.19-9.20
Eye
Wash..... 2.08, 8.52
Wash Station..... 2.08, 8.50
Face Shields..... 2.11
Fall Protection..... 2.03-2.05
Fan..... 6.07
Fan
Belts..... 5.46-5.47
Blades..... 5.45
Filler, Repair Body..... 1.27
Filters, Air, Fuel, Hydraulic & Oil..... 1.28-1.48, 5.13-5.14
Fire Extinguisher..... 2.15
First Aid Kits..... 2.18
Flaps..... 11.29
Flashing Lights..... 2.16, 4.07, 6.07
Flashlight..... 1.03, 9.04, 9.16
Float Systems & Parts..... 8.23-8.26, 8.28-8.31

Floor
 Cleaner..... 1.13, 3.08, 8.51
 Mats..... 1.22, 2.17, 3.19, 8.51
 Signs..... 3.09-3.10
 Tape..... 3.05-3.08
 Fluids..... 1.04-1.05
 Fluorescent Dye..... 1.03
 Fork..... 7.09-7.10, 7.17
 Covers, Magnetic..... 7.11
 Extenders..... 7.11
 Flags..... 7.09
 Labels..... 7.09
 Pallet Protector..... 7.12
 Pin Kits..... 7.08
 Wear Calipers..... 7.10, 9.05
 Forklift
 Cover..... 6.19
 Jack..... 9.06
 Laser Guidance Systems..... 6.16-6.18
 Fuel Filters..... 1.28-1.48, 5.14
 Fuel/Water Separators Filters..... 1.28-1.48, 5.14
 Fuses..... 4.20-4.23
 Gas Springs..... 4.55, 5.61
 Gaskets..... 1.26-1.27, 5.19, 5.52
 Gear Oil..... 1.03
 Genie OEM Parts..... 3.22-3.23
 Glasses, Safety..... 1.03, 2.07-2.08
 Gloves..... 1.16-1.18, 2.13
 Goggles..... 2.08
 Grease..... 1.06-1.07, 1.12
 Guns..... 1.07, 9.23
 Fittings..... 4.45, 5.59
 Pump..... 1.07
 Grip, Handle..... 4.50-4.51
 Grounding Strap..... 4.12
 Hand Cleaners..... 1.08
 Hand Truck Dolly..... 3.15, 9.05
 Hand Trucks
 P-Handle..... 3.15
 Personal..... 3.15, 9.05
 Handles..... 4.48, 4.50-4.51, 5.29, 8.43
 Hard Hat..... 2.14
 Harnesses
 Body..... 2.03-2.04
 Wire..... 4.48, 4.51, 7.04
 Heat Shrink Tubing..... 8.47
 Hopper..... 3.16-3.17
 Horn..... 4.09-4.10, 5.62
 Parts..... 4.52, 4.70-4.71, 5.62
 Hose..... 5.24, 5.62, 8.24-8.31, 8.33-8.36, 10.04-10.08
 Sheave..... 5.29, 5.61
 Hour Meters..... 4.31-4.32
 Hubs..... 11.30-11.31
 Cover..... 5.61
 Hydraulic
 Filters..... 1.28-1.48, 5.64
 Fluid..... 1.04-1.05
 Oil..... 1.02-1.03
 Oil Additive..... 1.03
 Pump..... 5.19
 Tools..... 9.09-9.12
 Hyster, Yale, Raymond Parts Breakdown
 4.33-4.35, 4.48-4.49
 IC Lift Truck Tools..... 9.22-9.23

Ignition
 Coils..... 5.42
 Rotors..... 5.38-5.42
 Switches..... 4.16-4.18
 Wire Sets..... 5.38-5.41
 InfoLink® Replacement Parts..... 7.04
 Injector..... 5.13-5.14
 Injector Watering System..... 8.32-8.36
 Intercell Shroud..... 8.38
 Intercells..... 8.38
 Jacks.....
 Forklift..... 9.06
 Machinery..... 3.13-3.14
 Trailer..... 3.14
 Jump Packs..... 8.22
 Key Pad..... 2.16, 6.08
 Keys..... 4.16-4.18
 Knee Pads..... 2.07
 Knife, Utility..... 1.24
 Knuckles..... 5.64
 Knurled Nut Replacements..... 4.18
 Labels
 Fork Tip Indicator..... 7.09
 Protectors..... 3.08
 Sideshift..... 7.10
 Ladders..... 3.10
 Lamps..... 4.04-4.07
 Lanyards..... 2.05-2.06, 2.11
 Lasers, Forklift Guidance System..... 6.16-6.18
 Lead, Pellets & Sticks..... 8.39-8.40
 Lead Wire..... 4.19
 Leadhead Shrouds..... 8.38
 Leadheads..... 8.39-8.40
 Leaf Chain..... 7.07
 Leak Detection..... 1.03
 LED
 Flashlight..... 9.04
 Knit Cap with LED Light..... 2.13
 Strobe..... 4.06-4.07
 Tail Lights..... 4.05
 Work Lights..... 4.03-4.05, 4.08, 6.07
 Lights
 Bulbs..... 4.02
 Dome..... 4.05, 6.07
 Flashing..... 4.07, 6.07
 LED..... 4.03-4.09
 Spotlight..... 4.03-4.05, 4.08-4.09
 Light Kits, Blue/Red..... 4.08
 Strobes..... 4.06-4.07, 6.07, 7.04
 Tail..... 4.05
 Work..... 4.03-4.05, 6.07
 Liners, Trash Can..... 1.21
 Lithium-Ion Batteries..... 8.16, 8.18
 Lithium Compact Batteries..... 8.18
 Load Wheel Assemblies..... 4.44, 11.10
 Load Wheel Kits..... 11.12-11.15
 Lockout Devices..... 2.15
 LPG
 Tanks..... 5.10
 Parts..... 5.10-5.14
 LPG Safety Valve..... 5.11
 Lubricants..... 1.12, 1.25
 Mask, Breathing..... 2.10
 Master Cylinders..... 4.68, 5.33

Mats, Floor..... 1.22, 2.17, 3.19, 8.51
 Mechanical Tools..... 9.05-9.08
 Meters..... 4.31-4.32, 9.14-9.16
 Mirrors
 Inspection..... 3.04, 9.03
 Safety..... 2.02
 Warehouse..... 3.04
 Modules, InfoLink®..... 7.03
 Monitors..... 6.14
 Motor Oil..... 1.02
 Motors
 Drive..... 4.58-4.60
 Pump..... 4.57-4.58
 Steer..... 4.60-4.61
 Neutralizing Wash..... 1.13, 8.51
 Oil Additive..... 1.03
 Oil Filters..... 1.28-1.48
 Oils..... 1.02-1.03
 Operator Training..... 12.02-12.03
 Pad
 Brake..... 5.29
 Contact..... 7.13
 Deadman..... 4.56
 Kneeling..... 2.07
 Spill Absorbent..... 2.17
 Paint..... 1.15
 Suit..... 2.13
 Pallet Trucks (PTH & PTH50S/PS)..... 7.05-7.06
 Pallets & Accessories..... 3.11
 Parking Block..... 3.12, 8.48
 Pin Kits, Fork..... 7.08
 Pins, Axles & Shafts
 4.33-4.42, 4.51, 5.56-5.58, 11.11-11.15
 Pipe..... 5.32
 Planned Maintenance & Tune-Up Kits..... 5.37
 Platforms..... 3.10, 6.08
 Plug Kits..... 4.11
 Pneumatic Tires..... 11.27-11.29
 Pogo Stick..... 8.08-8.09
 Poly Tires..... 11.19-11.20
 Potentiometer..... 3.20, 4.53, 9.15
 Power Cable..... 4.19, 8.46
 Power Cord, Replacement..... 4.70, 8.12
 Power Supply..... 4.29, 7.04
 Fuel/LPG Parts..... 5.10-5.14
 Propane Tanks..... 5.10
 Protection
 Breathing..... 2.10
 Charger Stand..... 8.06
 Rack..... 3.03
 Ear..... 2.09
 Fall..... 2.03-2.05
 Prybar..... 9.08
 Pumps
 Battery Watering..... 8.24, 8.28, 8.33
 Grease..... 1.07
 Hand..... 1.03, 1.08, 1.13, 9.12
 Hydraulic..... 5.19
 Motors..... 4.57-4.58
 Transmission Charging..... 5.52
 Water..... 5.18-5.19
 Quick Change Load Wheels..... 11.10
 QuickPick® Remote..... 6.19

Section 13 - Index

Rack	
Battery Display	8.19
Tire	11.21
Rack Protection	3.03
Radiators & Accessories	5.22-5.25
Rags	1.18-1.21
RAM Mounts	6.09-6.12
Ramp	9.05
Raymond, Hyster, Yale Parts Breakdown	
.....	4.33-4.35, 4.48-4.49
Regulator	5.12, 8.29-8.31, 8.36, 8.50
Repair Body Filler	1.27
Rescue Booster Pack	8.22
Reservoir	4.68
Cap	5.55
Resilient Tires	11.27-11.29
Respiratory	
Cartridges	2.10
Masks	2.10
Rightline	
Replacement Parts	7.18-7.20
Fork Assemblies	7.17
Rims	11.29
Risers	4.33-4.36
Roller Chain	7.08
Rotors	5.38-5.42
Rubber Tires	11.22-11.26
Safety	
Cones	2.16
Glasses	1.03, 2.07-2.08
Vests	2.12
Sanding Discs	1.15, 9.23-9.24
Sealant	1.24-1.27
Seals	5.48-5.51
Seat	
Belts	2.02, 5.09
Cushions	5.08
Switches	5.02-5.08
Tracks	5.08
Seats	5.02-5.07
Self-Retracting Lanyard	2.05
Self-Retracting Life Line	2.06
Sensor	4.53, 4.69, 4.72, 5.14, 5.53-5.54, 7.04
Service Training	12.04-12.05
Shafts, Axles & Pins	
.....	4.33-4.42, 4.48-4.49, 4.53-4.55, 11.11-11.15
Shoe Covers	2.11
Shoes, Brake	5.26-5.28
Shop Vac	9.05
Shrink Wrap	1.24
Shrink Wrap Holders	6.02, 6.06
Shrouds, Leadhead & Intercell	8.38
Sideshift Label	7.10
Signs	3.09-3.10
Sleeving	8.46
Solenoids	3.20, 3.22, 4.30-4.31, 4.48, 4.70, 5.17, 5.61
Spark Plug	
Tube	5.42
Wires	5.37-5.41

Spark Plugs	5.43-5.45
Spill Kits	1.13, 2.17-2.18, 8.51-8.52
Spotlights	4.04-4.05, 4.08
Spray Nozzle Quarts	1.14
Sprayer/Bottles	1.14
Springs	4.46, 4.48, 4.51, 4.54, 4.71-4.72
Brake	5.28-5.31
Brush	4.66-4.68
Gas	4.48, 4.55, 5.61-5.62
Return	4.51, 4.55, 4.72
Starters	5.15-5.17
Static Strap	4.12
Steer Motors	4.60-4.61
Steering Link	5.59-5.60
Steering Tools	9.16
Storage Net	6.05
Storage Trays	3.11, 6.04-6.05, 9.04
Stretch Film	1.24
Strobe Lights	4.06-4.07, 6.07, 7.04
Suppressor	4.10
Switches	3.20, 4.12-4.18, 4.48, 4.52, 4.71-4.73, 5.02-5.08, 5.14, 5.53, 5.63
Tack Cloth	1.15
Tail Lights	4.05
Tanks, LP	5.10
Tape	
Adhesive	1.23
Applicator	3.06
Caution	2.15
Dispenser	1.24
Floor	3.05-3.08
Tender Kit	8.09
Terminal	
Battery	5.63, 8.41-8.45
Lugs	8.46
Mounting Plates	6.03
Protectors	8.41
Thermostats	5.25
Throttle, Body	5.13
Tie Rod End	5.60
Ties, Cable	1.21, 8.46
Tips, Contactor	4.26
Tire Chains	11.32
Tires	
Application Guide	11.19
Hole	11.21
Poly	4.53, 11.19-11.21
Rack	11.21
Resilient/Pneumatic	11.27-11.29
Rubber	11.22-11.26
Sweeper Scrubber	11.26
Tools	
Battery	8.30, 8.36, 8.47-8.50
Box	9.04
Brake	9.17
Crimping	4.11, 8.49, 8.50, 9.10, 9.19-9.20
Crown Branded Tools	9.02-9.04
Diagnostic	9.14-9.16

Drive	9.13
Electrical	9.18-9.20
Extraction	9.19-9.20
Hydraulic	9.09-9.12
IC Lift Truck	9.22-9.23
Mechanical	9.05-9.08
Retractor	6.08, 9.06
Steering	9.16
Towels	1.18-1.21
Traffic Cones	2.16
Training Programs	12.02-12.05
Transmission	
Evacuator	9.17
Filter	1.28-1.48
Fluid	1.04
Strainer & Cup	5.52
Trash Can Liners	1.21
Trauma Strap	2.04
Trays, Storage	3.11, 6.04-6.05, 9.04
Tubes	
Bicycle/Tricycle	3.18
Tire	11.29
Tubing, Heat Shrink	8.47
Tune-Up & Planned Maintenance Kits	5.37
Unigauges	4.31-4.32
Utility Knife & Blades	1.24
UV Flashlight	1.03, 9.16
Valve	5.14, 5.52-5.53
Vaporizer	5.12-5.13
Vest, Safety	2.12
Washer Fluid	1.05
Water Pump	5.18-5.19
Watering, Battery	8.23-8.36
Barbed	8.23
Welding Jacket	2.13
Wheel Axles	4.33-4.38, 11.07, 11.11-11.15
Wheels	
Wheel Selection & Application Guide	11.02-11.03
Casters	4.45, 11.07-11.08
Chocks	3.12-3.13, 9.21
Cylinder	5.33-5.34
Load Wheel Assemblies	11.10
Load Wheel Kits	11.10-11.15
Non-Polyurethane	11.06
Dual Tandem Load Wheels	11.11
Polyurethane	4.44, 11.04-11.06
Quick Change	11.10
Triple Load Wheel	11.11
Windshield Washer Fluid	1.05
Wiper	
Blades	1.14
Towels	1.18-1.21
Wipes, Cleaner/Disinfectant	1.11
Wire	4.19
Wire Sets, Ignition	5.37-5.41
Work Assist®	6.02-6.19
Work Lights	4.03-4.05, 4.08-4.09, 6.07
Yale, Hyster, Raymond Parts Breakdown	
.....	4.33-4.35, 4.48-4.49

START UP YOUR SYSTEM OF SAVINGS.



A full-service parts and service system provider.

Crown doesn't just want to sell parts. By observing how you use your forklift and understanding your specific needs, Crown collaborates to deliver the long-term durability and value you expect.

Combine all this with Crown's forklift quality, replacement part accessibility, part commonality, proven technical service and an operator-friendly, ergonomic design, and you'll experience uptime like no other.

With Crown and our retail network, you'll benefit from:

- ▶ A well-managed dealer parts inventory
- ▶ Quick delivery
- ▶ Online parts ordering
- ▶ Exceptional customer service

**These benefits add up to less downtime,
easier and faster parts replacement and
longer truck life.**

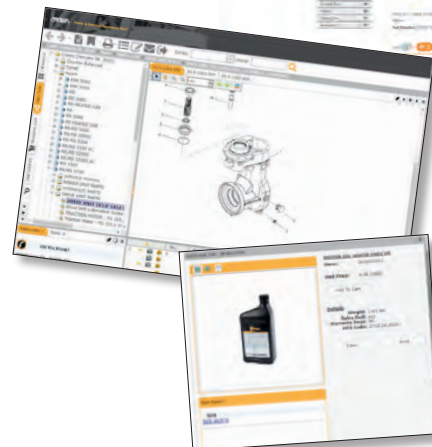

◀ Our online Parts and Service Resource Tool (PSRT) system allows customers to find exactly what they need.

Red LED Arc Light

- Projects a red arc on the floor in the direction of travel.
- Polycarbonate lens; can be used in food applications.
- Internal components protected from moisture, vibration and corrosion.
- Sleek and compact.
- Easy to install.



See Section 4 for
Electric Truck Components

CROWN

V-FORCE

100-277V Single Phase Charger

Now Available

- Lead-Acid and Lithium-Ion capable.
- Multi-voltage charge capacity: charges 12V, 24V, 36V, and 48V.
- Output options of 48A, 85A, 120A, and 240A.
- 100-277V Single Phase Charger.
- Available in both full-feature (HFM³) and economy (HFE³) versions.



See Battery and
Charger section

CROWN

Contact Your Local Dealer:

Note: 1910.178(q)(5) (1998) of the Occupational Safety and Health Act (OSHA) requires that "All parts of any such industrial truck requiring replacement shall be replaced only by parts equivalent as to safety with those used in the original design."

CROWN

Crown Equipment Corporation

New Bremen, Ohio 45869 USA

Tel 419-629-2311

Fax 419-629-2099

crown.com

Because Crown is continually improving its products, specifications are subject to change without notice.

Crown, the Crown logo, the color beige, Crown Integrity Parts, Integrity Parts System, Integrity Service System, Wave, Work Assist, Demonstrated Performance, V-Force, One Source Lift Truck Parts, and InfoLink, are trademarks of the Crown Equipment Corporation in the United States and other countries.

Other trademarks are the property of their respective owners.

Copyright 2005-2024 Crown Equipment Corporation
PF14434 Rev. 02-24 Vol. 34 Printed in U.S.A.