



2024 PRODUCT CATALOG



WAREHOUSE SOLUTIONS

YOUR SOLUTION FOR
WAREHOUSE PRODUCTS

Built to Handle Virtually Anything

Standard Features:

- 5000 lb. weight capacity
- 5" lift height
- Durable hydraulic system
- Easily replaceable pump valve cartridge
- Sealed and lubricated for life bushings and bearings
- Articulating steer wheels



Model Numbers:

- PTH 50-27-48 (width 27", length 48")
- PTH 50-20-48 (width 20", length 48")
- PTH 50-20-36 (width 20", length 36")

Standard Features:

- 4500 lb. weight capacity
- Max. Lift Height of 9.25"
- Heavy-Duty drive unit
- AC traction system
- e-GEN® braking
- X10 Handle®



Model Numbers:

- WP 3225
- WP 3230
- WP 3235
- WP 3240
- WP 3245

Only Crown delivers the newest and widest range of rental trucks backed by the industry's most responsive and qualified dealer network.

Call Crown today for the
RIGHT TRUCK
RIGHT NOW

1-877 RNT LIFT

1-877-768-5438

crown.com



RM 6000
Narrow-Aisle Reach Truck

CROWN



Warehouse Solutions

2024 Catalog

Table of Contents

Warehouse Design	2
Before & After	4
Featured Products	6
Featured Suppliers	41
Rack & Shelving	49
Safety	101
Shop & Warehouse	124
Battery Handling	180
Hand Trucks & Carts	192
Storage	226
Drum Handling/Cylinder Storage	241
Dock Equipment	249

Crown takes an integrated approach to your material handling needs

Crown material handling specialists can help you find solutions that improve throughput, enhance efficiency and reduce costs. Our associations with quality manufacturers and suppliers ensure a comprehensive selection of material handling products. No matter what material handling challenges you face, Crown has the material handling expertise and resources to deliver solutions that give you a distinct advantage.

One of the most common material handling challenges is the need to maximize space and productivity. Crown specializes in warehouse design that enables the lift truck and rack to work as a system. A careful analysis enables Crown material handling specialists to save you valuable square footage and reduce the time required to store and retrieve products.

Choosing the right rack system is one way to make a significant difference. Your local Crown branch can help you determine the ideal solution based on your individual needs and the benefits you wish to achieve.

With Crown, you'll benefit from a full range of solutions with the flexibility to choose products from quality manufacturers and suppliers based on your unique requirements.

Many facilities install selective rack systems, while others choose rack systems integrating combinations of double-deep, drive-thru, cantilever, push-back, flow-thru racks and other options. The type of lift truck also determines how effectively you can maximize space and improve your material handling.

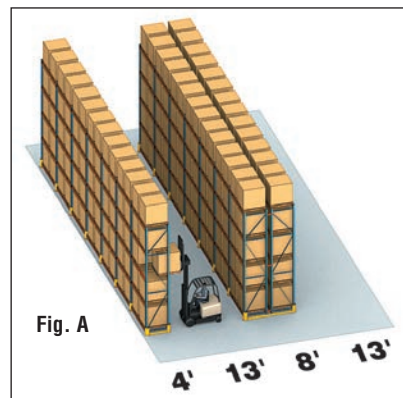

Selective Rack
Counterbalanced Lift Truck

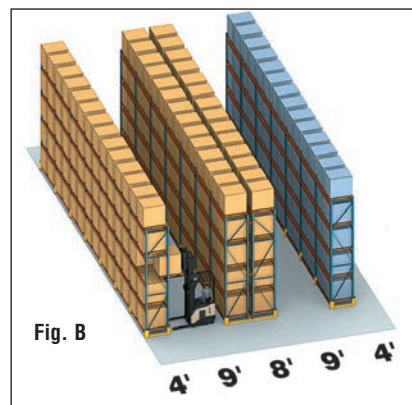

Selective Rack
Rider Reach Truck
33% more storage over Fig. A

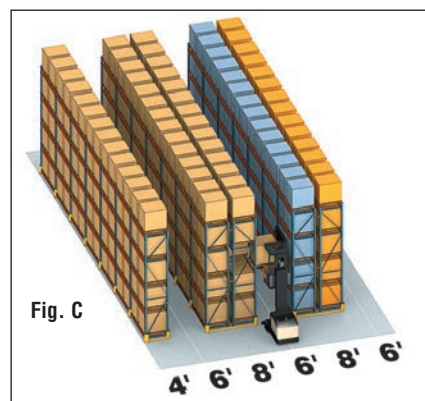

Selective Rack
Turret Stockpicker
25% more storage over Fig. B; 66% more storage over Fig. A

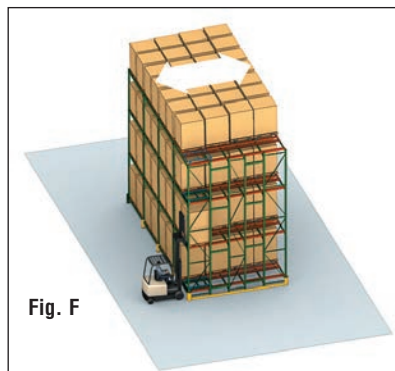

Push-Back Rack
First-in, last-out
Variable truck and aisle

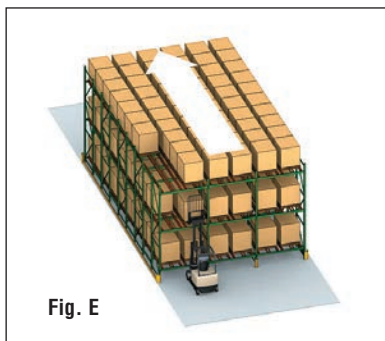

Flow-Thru Rack
First-in, first-out
Variable truck and aisle

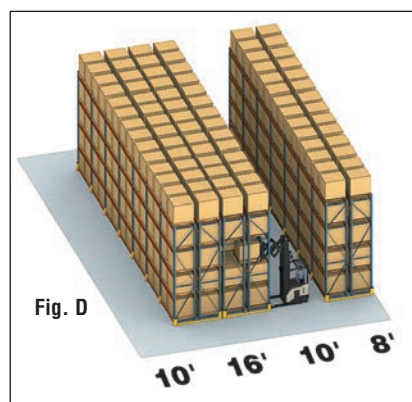

Double-Deep Rack
Double Reach Lift Truck
8.5'-11' aisle width

Let us help you design, plan and install your next warehouse project.

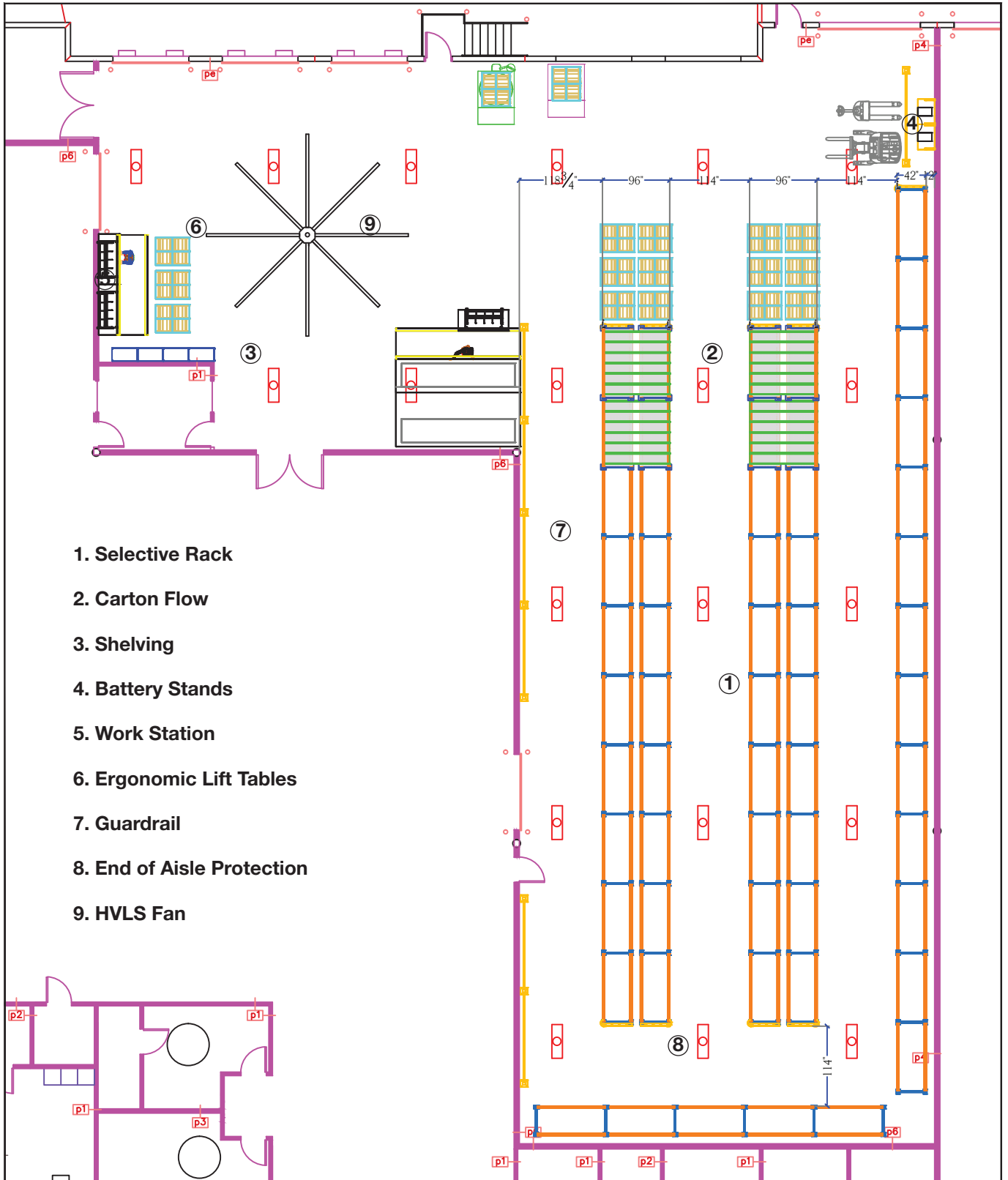

Innovation at work; see the results ...

Before



After



Vertical space was utilized for handling long loads with a Crown SP 3500 Series Stockpicker and cantilever rack.



A new 85,000 sq. ft. facility transformed with customized racking for 10,334 pallet positions. Designed for efficient material handling using Crown's RM 6000 Reach Trucks, RC 5500 Stand-Up Counter-Balanced Trucks, and PC 4500 Center Control Pallet Truck.



Very narrow aisle cube utilization for low volume picking. This electronics company gained an additional 80,000 cu. ft. of storage by going up. The shelving system is over 18' high and Crown SP 3500 Stockpickers are used to pick and fill orders.

Before



After



A paper company in Massachusetts added 60,000 sq. ft. to their facility to house more than 5,800 additional pallet positions. The new distribution center utilizes 300" Crown RM 6000 Series Reach Trucks, 270" SP 3500 Stockpickers, to case pick orders and RC 5500 Stand-Up Counter-Balanced Trucks in the dock area to receive and ship product.

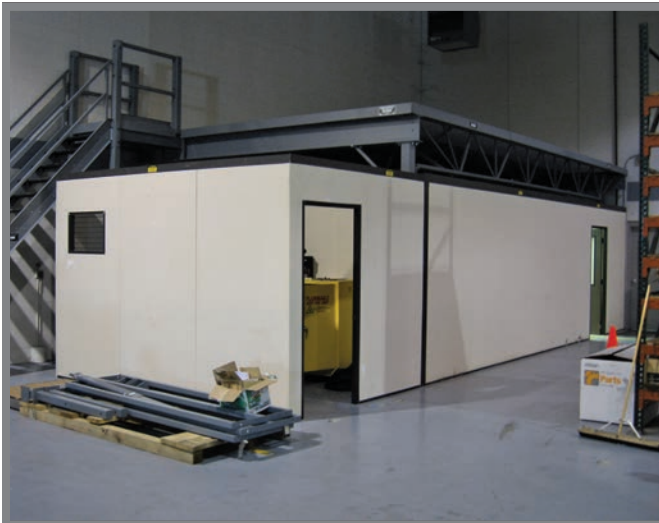

Instead of expanding the building, this customer incorporated a modular office above and below a work platform. The end result: three offices and a new training room.



A party rental store added an additional 10,000 square feet of storage by going up. The shelving system is over 18' high and uses Crown SP 3500 Stockpickers to fill orders.

RACKING

Pallet racking systems are designed using two basic components: welded vertical end frames and one-piece interlocking horizontal beams. Beams engage into frames on 3" increments and come standard with safety clips to prevent disengagement from frames. All racking systems are designed and manufactured in accordance with applicable regulations and specifications.

FRAMES: Standard sizes are available in 24" to 72" depths. Special sizes are available. We will design and manufacture to suit any customer requirement.

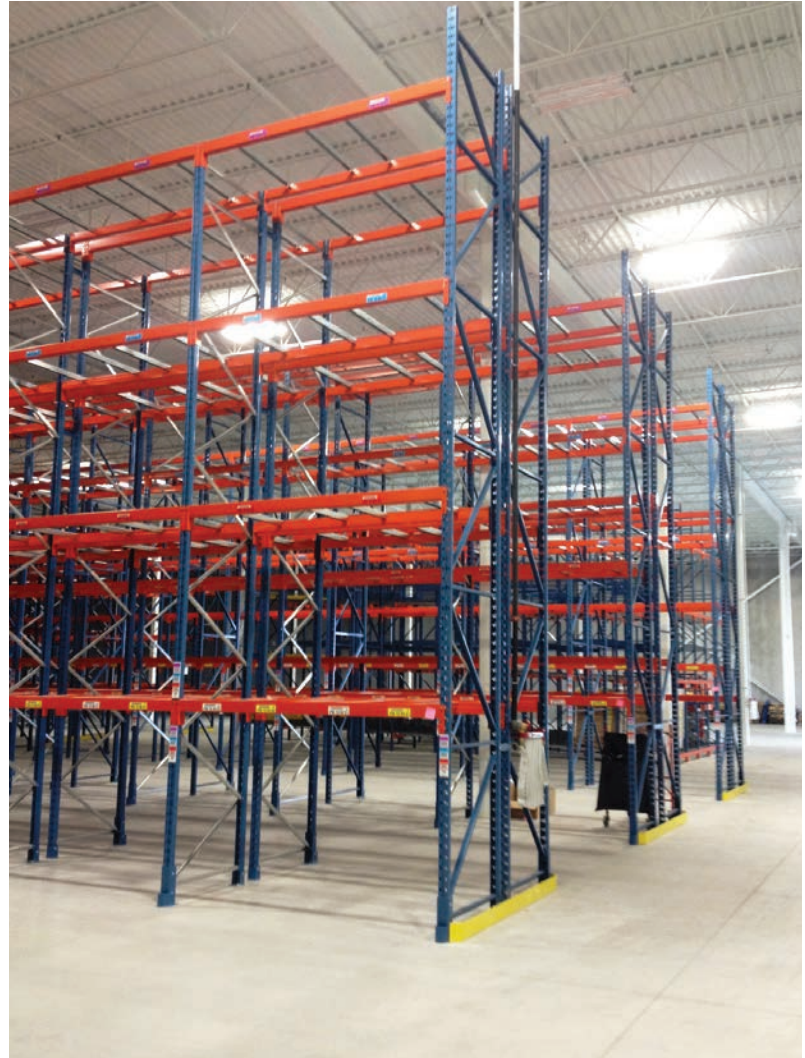

BEAMS: Available in roll formed or structural steel. Beam capacities range from 1,000 lbs. to 12,000 lbs. per pair and are available in many lengths. Beams are typically used to store conventional pallets and work best using accessories such as safety bars or wire mesh decks. Step beams allow for drop-in panels, wooden shelves, wire mesh and many additional accessories designed for product stacking and hand pick applications.

GUARDING

A SAFE WORKPLACE FOR ALL



**Safety 24/7.
Install a guard rail
system and create
a protective shield
between your workers
and your equipment.**

SHELVING

Boltless shelving allows for ease of installation without compromising on safety or capacity.

It also looks great.



SHELF SIZE

CAPACITY

12" x 36"	800 lbs*
15" x 36"	800 lbs*
18" x 36"	800 lbs*
24" x 36"	800 lbs*

12" x 42"	650 lbs*
15" x 42"	650 lbs*
16" x 42"	650 lbs*
18" x 42"	650 lbs*
24" x 42"	650 lbs*

12" x 48"	550 lbs*
15" x 48"	550 lbs*
18" x 48"	575 lbs*
24" x 48"	600 lbs*

**Uniformly distributed load*





MODULAR IN-PLANT OFFICES

Manufactured by A-WALL

Two-Story Warehouse Offices

The Flexible Alternative to Permanent Construction

When you need to enclose personnel, a process or products, consider modular offices over permanent construction.

- Cost Effective
- Versatile
- Customizable

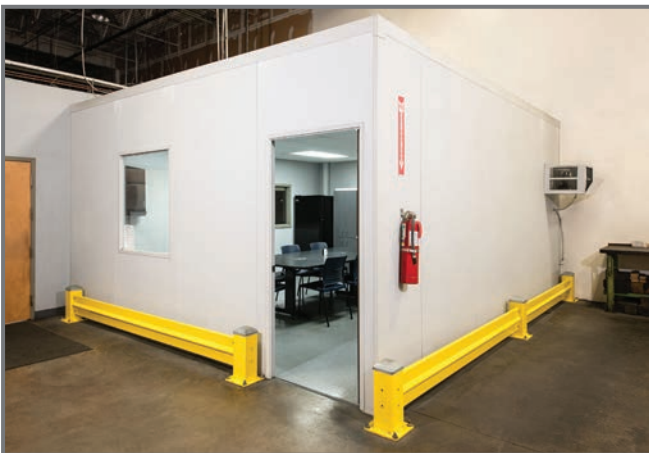

Warehouse Break Room Sharing a Common Wall



A-WALL's In-Plant Office with Gray Panels and Carpet

STORAGE PLATFORMS



Allow our Warehouse Solutions Specialist to provide an innovative storage solution for you

Whether you need additional space in your warehouse, parts department, office, or retail store, there is always a good reason to install a storage platform. We can

build an industrial strength platform around the existing layout of your facility, matching its exact height, area and load requirements.

Safety Products

Personnel Barriers

Machine Guarding

Rack Protection

Shelf Protection

Column Protection

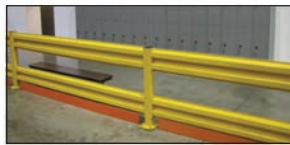

Safety Rail



Safety Barrier



End of Aisle Guards



Rack Upright Guards



Guide Rail



Building Post Guard

Please contact your local Crown representative.



Bollards





Pallet Trucks

Hand Pallet Trucks

Recognized for their exceptional versatility and durability, hundreds of thousands of Crown hand pallet trucks are in use around the globe today. Our hand pallet trucks demonstrate the Crown commitment to quality, offering years of productive use at a lower total cost of ownership.

Walkie Pallet Trucks

Crown walkies are considered the workhorse of their operations by many customers. Designed for exceptional maneuverability, precise control and superior load stability, the WP 3200 is the ideal truck for working in tight spaces in fast-paced, demanding operations. The ultra-rugged PW Series improves productivity when handling heavier load weights and working in the most extreme environments.

Rider Pallet

Crown rider pallet trucks lead the market for both low-level order picking and high-speed transporting. Key operator productivity preferences are addressed with either the end controlled PE Series, the center controlled PC Series with electronic power steering or the side-stance rider PR Series, with power steering.

Crown's PC 4500 equipped with QuickPick® operator assist technology transforms low-level order picking.

Tow Tractors

The TR 4500 features a powerful AC drive unit for long lasting performance and a rugged design to provide superior uptime in the most demanding applications.

Crown's tugger can be equipped with electronic power steering or manual steering.



PTH 50 Series
Hand Pallet Truck
Load Capacity: 5,000 lbs.
Available with:
• Load Tray



PTH 50S Manual Scissor Lift
PTH 50PS Powered Scissor Lift
Hand Pallet Truck
Load Capacity: 2,200 lbs.
Max. Lift Height: 31.3 in.

Manual Shown



WP 3200 Series
Walkie Pallet Truck
Load Capacity: 4,500 lbs.



PW 3500 Series
Walkie Pallet Truck
Load Capacity: 6,000 - 8,000 lbs.



PE 4500 Series
End-Control Pallet Truck
Load Capacity: 6,000 - 8,000 lbs.
Forks: Double and triple lengths available
Power steering available



PR 4500 Series
Rider Pallet Truck
Load Capacity: 6,000 - 8,000 lbs.
Forks: Double and triple lengths available



PC 4500 Series
Center-Control Pallet Truck
Load Capacity: 6,000 - 8,000 lbs.
Forks: Double and triple lengths available



RT 4000 Series
Rider Pallet Truck
Load Capacity: 4,500 lbs.
Forks: Double length available

Available with:
• QuickPick Remote and Rapid Systems



TR 4500 Series
Tow Tractor
Rolling Load Capacity: 10,000 lbs.



Walkie Stackers

Straddle and Fork-Over

Straddle stackers work in extremely confined spaces, allowing more efficient use of limited storage areas. They give you the benefits of low initial cost and low operating expenses. Many models include adjustable outriggers so you can straddle multiple size loads.

Fork-over designs are also available to efficiently handle wire baskets, plastic pallets and products on skids. Because the outriggers are positioned underneath the forks, the outrigger space required for straddle stackers is eliminated, increasing cube utilization.

Reach

The addition of a pantograph reach mechanism on a conventional stacker adds tremendous load-handling versatility. Designed for heavy-duty cycles and harsh surroundings, Crown walkie reach trucks offer years of reliable use.

Counterbalanced

The Crown counterbalanced design offers the versatility of a counterbalanced fork lift and the economy of a walkie stacker. It handles many tasks that otherwise would require the use of more expensive equipment.

M 3200 Series
Walkie Straddle Stacker
Load Capacity: 2,000 lbs.
Max. Lift Height: 144 in.



ST 3200 Series
Walkie Straddle Stacker
Load Capacity: 2,500 lbs.
Max. Lift Height: 168 in.



SX 3200 Series
Walkie Straddle Stacker
Load Capacity:
3,000 - 4,000 lbs.
Max. Lift Height: 192 in.



SHR 5500 Series
Heavy-Duty Walkie
Reach Stacker
Load Capacity:
2,500 - 3,000 lbs.
Max. Lift Height: 192 in.



SH 5500 Series
Heavy-Duty Walkie
Straddle Stacker
Load Capacity: 4,000 lbs.
Max. Lift Height: 132 in.



SHC 5500 Series
Heavy-Duty Counterbalance
Walkie Stacker
Load Capacity: 2,500 - 4,000 lbs.
Max. Lift Height: 172 in.



ES 4000 Series
Fork over Stacker
Load Capacity: 3,500 lbs.
Max. Lift Height: 132 in.





Man-Up Trucks

Very Narrow-Aisle Turret Trucks

The TSP Series line of turret trucks offers the versatility to handle a wide range of warehousing challenges including full pallet handling and case picking. Industry-unique features like the MonoLift® Mast, MoveControl® Seat and Crown's Regenerative Lowering System provide the edge to get more done and use less energy. Lifting to heights up to 675 inches and with a maximum capacity of 3300 lbs., the TSP Series operates in aisles only inches wider than the truck itself.

Order Pickers

Every element of the Crown SP 3500/4000 Series lift truck is designed to work with the operator to optimize the order picking process. Based on operational needs, Crown can deliver more speed, capacity at height and features including variable lift/lower and regen lower. The Crown Stockpicker family also includes two SP 3500 Four-Point Series models for handling non-standard loads and low level order picking with the MPC 3000 Series and GPC Series.

Wave® Work Assist Vehicle

Elevates a person to effective work heights up to 17 feet, along with merchandise, tools or other materials weighing up to 200 lb. The Wave® allows one person to do a job that would normally require two employees, and does it safer, reducing the risk of worker injury and product damage.



TSP 1000 Series (shown)
Turret Stockpicker
Load Capacity: 3,300 lbs.
Max. Lift Height: 531 in.

TSP 1500 Series
Turret Stockpicker
Load Capacity: 3,300 lbs.
Max. Lift Height: 675 in.

- Available with:**
- Auto Positioning System
 - Auto Fence



SP 1500 Series
Stockpicker
Load Capacity: 3,000 lbs.
Max. Lift Height: 402 in.



SP 3570F Series
Straddle
Load Capacity: 3,000 lbs.
Max. Lift Height: 366 in.



MPC 3000 Series
Order Picker with Mast
Load Capacity: 2,600 lbs.
Max. Lift Height: 169 in.

- Available with:**
- QuickPick Remote System

SP 3580F Series (shown)
Platform and Cart Handler
Load Capacity: 1500 lbs.
Max. Lift Height: 366 in.



WAV 60 Series
Work Assist Vehicle
Load Capacity: 300 lb. operator,
200 lb. load tray, 250 lb. load deck
Platform Lift Height: 118 in.



GPC 3000 Series
Low Level Order Picker
Load Capacity: 6,000 lbs.
Forks: Available only in double length
Platform Lift Available

- Available with:**
- QuickPick Remote System

TSP 1500





RC 5700 Series

Tire: Cushion
 Power: Electric 36V
 Load Capacity: 3,000 - 4,000 lbs.
 Max. Lift Height: 276 in.



SC 5700 Series

Tire: Cushion Pneumatic
 Power: Electric 36/48V
 Load Capacity: 3,000 - 4,000 lbs.
 Max. Lift Height: 276 in.



FC 5700 Series

Tire: Cushion
 Power: Electric 36/48V
 Load Capacity: 4,000 - 6,500 lbs.
 Max. Lift Height: 312 in.



SC 6200 Series

Tire: Pneumatic
 Power: Electric 48V
 Load Capacity: 3,500 - 4,300 lbs.
 Max. Lift Height: 295 in.



C-B Series

Tire: Pneumatic
 Power: Electric 80V
 Load Capacity: 8,000 - 10,000 lbs.
 Max. Lift Height: 238 in.



Rider Counterbalanced Trucks

3-Wheel Stand-Up

The RC Series excels at dock work, transporting and put-away tasks with its easy on/off ergonomic operator compartment designed for exceptional comfort and performance.

3-Wheel Sit-Down

The highly maneuverable three-wheel SC design is ideal for precision load placement in tight spaces.

4-Wheel Sit-Downs

The SC Series four-wheeled forklift is a multi-purpose truck with an increased maximum lift height that offers a unique edge on ergonomics, stability and maneuverability. The higher capacity, attachment-friendly four-wheel FC fork lift truck is designed to handle the toughest applications.

RC 5700



FEATURED PRODUCTS

SC 6200





Reach Trucks

Conventional Mast

The RR 5700 Series was designed to deliver the optimum performance you require for your specific application. The RR Series delivers the right lift, lower and travel speeds to match operator, application and task, as well as OnTrac® Anti-Slip Traction Control and variable side-stance positioning.

A fold-down seat on the RR 5700 S Class Series Reach Truck allows operators to sit, lean or stand, increasing their comfort and productivity in the fast-paced, narrow-aisle environment.

MonoLift® Mast

The RM 6000 Series with the exclusive MonoLift® mast delivers breakthrough heights, capacities, visibility and energy for greater operator, truck and operation-wide productivity.

The RM 6000 Series includes industry-leading travel and lift speeds, as well as OnTrac® Anti-Slip Traction Control and variable side-stance positioning. The operator compartment of the RM 6000S Class Series allows operators to sit, lean or stand for optimal comfort throughout the shift.

Moving-Mast (Sit-Down)

The ESR 1200 Series moving mast reach truck is flexible enough to do the job of multiple trucks from dock to transport and replenishment/retrieval.



RR 5700 Series
Load Capacity: 3,500 - 4,500 lbs.
Max. Lift Height: 400 in.



RR 5700S Series
Load Capacity: 4,500 lbs.
Max. Lift Height: 442 in.

RD 5700 Series
Deep Reach
Load Capacity: 3,200 lbs.
Max. Lift Height: 400 in.

RD 5700S Series
Deep Reach
Load Capacity: 3,200 lbs.
Max. Lift Height: 442 in.



RM 6000 Series
Load Capacity: 4,500 lbs.
Max. Lift Height: 400 in.



RM 6000S Series
Load Capacity: 4,500 lbs.
Max. Lift Height: 505 in.



ESR 1200 Series
Load Capacity: 3,000 - 4,500 lbs.
Max. Lift Height: 534 in.

RMD 6000 Series
MonoLift® Mast Deep Reach
Load Capacity: 3,200 lbs.
Max. Lift Height: 400 in.

RMD 6000S Series
MonoLift® Mast Deep Reach
Load Capacity: 3,200 lbs.
Max. Lift Height: 505 in.

RM 6000



RR 5700

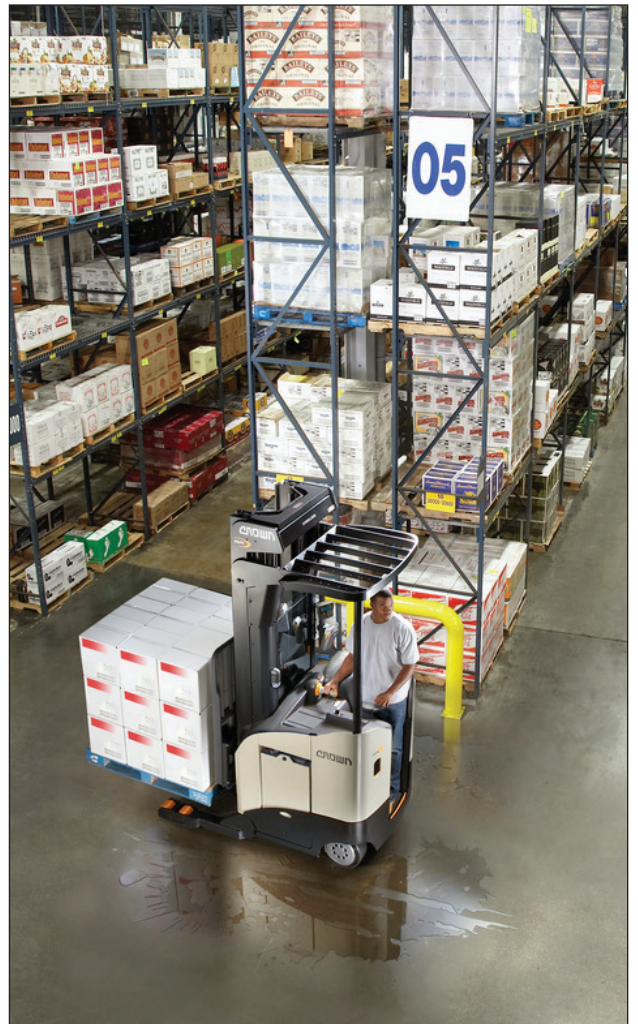



Internal Combustion Trucks

Cushion Tire

The C-5 Series cushion tire truck offers more power to do more work and includes revolutionary features that provide uptime benefits to lower users' total cost of ownership. In addition, the C-G Series truck is perfectly suited to handle larger load capacities in the most extreme environments.



C-5 Series

Tire: Cushion
 Power: Internal Combustion (LPG)
 Load Capacity: 4,000 - 6,500 lbs.
 Max. Lift Height: 294 in.



C-G Series

Tire: Cushion
 Power: Internal Combustion (LPG)
 Load Capacity: 8,000 - 12,000 lbs.
 Max. Lift Height: 276 in.

C-G Series

Tire: Cushion
 Power: Internal Combustion (LPG)
 Load Capacity: 3,000 - 4,000 lbs.
 Max Lift Height: 236 in.





Pneumatic Lift Trucks

Crown 8,000 to 12,000 pound pneumatic forklifts combine truck performance and operator-centric design with Crown's proven support network to deliver a tough material handling solution that exceeds expectations.

Crown 13,500 to 55,000 pound pneumatic forklifts merge rugged strength and durability with the comfort, control and confidence inspired by their operator-focused compartments.



C-5 Series

Tire: Pneumatic
 Power: Internal Combustion (LPG)
 Load Capacity: 4,000 - 6,500 lbs.
 Max. Lift Height: 294 in.



C-5 Pneumatic Diesel

Tire: Pneumatic
 Power: Internal Combustion (Diesel)
 Load Capacity: 5,000 - 6,500 lbs.
 Max. Lift Height: 294 in.

3,000-4,000 lb.
 capacity



C-G Series

Tire: Pneumatic
 Power: Internal Combustion (LPG)
 Load Capacity: 3,000 - 4,000 lbs.
 Max. Lift Height: 236 in.

8,000-12,000 lb.
 capacity



C-G/C-D Series

Tire: Pneumatic
 Load Capacity:
 8,000 - 12,000 lbs.
 13,500 - 20,000 lbs.
 Max. Lift Height:
 238 in.
 276 in.



13,500-20,000 lb. capacity



C-D Series

Tire: Pneumatic
 Power: Internal Combustion (Diesel)
 Load Capacity: 22,000 - 36,000 lbs.
 Max. Lift Height: 256 in.



C-D Series

Tire: Pneumatic
 Power: Internal Combustion (Diesel)
 Load Capacity: 40,000 - 55,000 lbs.
 Max. Lift Height: 236 in.





Mobile Work Positioning Solutions

Scissor Lifts

Elevate comfort and productivity with Crown's hand pallet truck with scissor lift. Available with manual or electrically powered hydraulics, scissor lifts provide ergonomic advantages for raising and transporting open-bottom containers and skids.



PTH 50S

Capacity: 2,200 lb
Max. Lift Height: Up to 31.3 in.



PTH 50PS

Capacity: 2,200 lb
Max Lift Height: Up to 31.3 in.



Mobile Work Positioning Solutions

Walkie Stackers

Designed with flexibility in mind, Crown stackers satisfy a wide range of applications with easy to use features to meet multiple needs. These include: stacking vertically on a rack system, positioning a portable work station at optimal height, simplifying maintenance tasks, shipping and receiving at ground level.



FEATURED PRODUCTS



M 3200 Series
Capacity: 2,000 lbs.
Max Lift Height: 144 in



ES 4000 Series
Capacity: 3,500 lbs.
Max Lift Height: 132 in

Contact your local Crown dealer or
Visit crown.com to learn more.

ATTACHMENTS



Choose from a variety of products that enable the conventional lift truck to become a more versatile and efficient materials handling tool. These products enable a lift truck to pull, push, clamp, lift, sideshift and rotate practically any unit load imaginable.



Carton Clamp

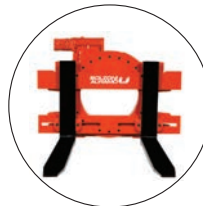
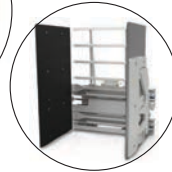

Rotator



Single Double Pallet Handler

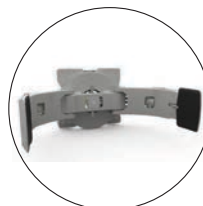

Paper Roll Clamp



Push Pull Attachment



Why Choose Crown FleetSTATS®?

Customers who select Crown's fleet maintenance management solution over other OEM or third party offerings see tremendous value in Crown's thorough, systematic approach to fleet tracking.

Proven: Many of Crown's largest fleet customers have used FleetSTATS for years to effectively manage fleets and control costs.

Focused: As an OEM with vested interest in our customers' total experience, we have a focused, long-term commitment to helping customers achieve lowest total cost of ownership.

Experienced: As a global brand with a dedicated dealer infrastructure, we deliver an experienced team that's fully aligned to help customers achieve their goals.

Leader: Crown has a track record of innovation—developing and deploying solutions that help material handling professionals achieve industry-leading operational results.

 **Crown FleetSTATS helps users consistently COLLECT valuable data, better CONTROL processes and CAPITALIZE on accurate, operation-wide information.**

FleetSTATS changes the way you manage—for the better. Customers experience better decision support and substantial savings since FleetSTATS provides an accurate picture of true maintenance costs.

crown.com

InfoLink

It's time to make the most of your connections.

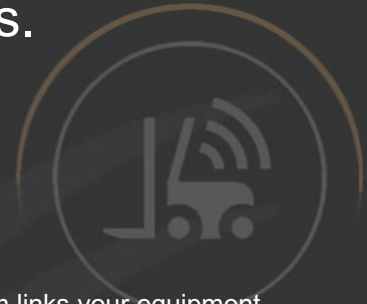
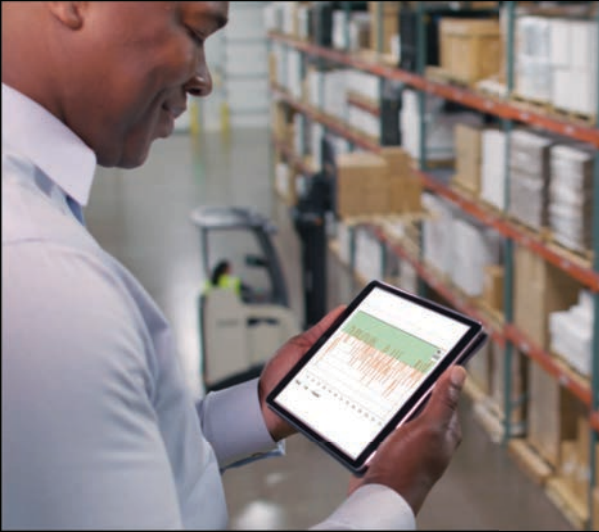

Crown's InfoLink system links your equipment, people and processes and connects you to information that matters, allowing you to make informed decisions about your fleet.



Improve operator safety by revealing best practices and areas of risk to help with targeted improvements for new and existing operators.



Accelerate improvement by optimizing your fleet to increase productivity in your operation.

InfoLink reinforces an experience-first approach that inspires operators and motivates safe behaviors. The interactive data keeps everyone informed.



InfoLink helps increase uptime by scheduling planned maintenance, encouraging proper battery care practices, capturing event codes and utilizing checklist feedback to identify repairs early.

Manage your assets more efficiently within the InfoLink software and connect with your fleet anytime, anywhere.



Customized reporting and interactive graphs can help you right-size your fleet and anticipate peak demand, reducing overall fleet costs.



Contact your local Crown dealer today and experience better results with InfoLink.

WORK EASIER

5-Second Charging and Pairing



Ready for Cold Storage

Order picking in cold storage environments typically requires gloves. The Fast-Charge Ring easily fits over gloves while buttons simplify operation. The QuickPick Rapid system is well suited to perform in temperatures as low as -25°F (-32°C).



Visit crown.com
See QuickPick Rapid in Action

Work Assist® Accessories & Options

Crown knows a clean, organized work environment means increased operator productivity. That's why Crown offers **Integrated Truck Solutions** that are designed to make the operator's job faster, easier, and more productive.



Clip Pad



Clip Pad and Hook



Shrink Wrap Holder



Storage Pocket



Shrink Wrap Tray



Cup Holder



Terminal Mounting Plates

For your warehouse management system or InfoLink terminal



ANATOMY OF AN encore[®] ELECTRIC FORKLIFT

Appearance

The interior of an electric Encore truck gets special attention during the remanufacturing process, including steam cleaning, dent/bent metal repair and new floor mats/pads.

Electrical

Crown replaces potentiometers, brushes, fuses and contactor assemblies. In addition, all wire harnesses, power cables, lights, gauges and switches are checked and replaced as necessary.

reNEWed Drive Units

Gear oil and the drain plug gaskets are replaced in every Encore lift truck. We also replace anything needed—without question—to ensure superior performance.

Structural

During remanufacturing, poly mast stops/bumpers, lift chains, mast shimming, forks, overhead guard, frame, power unit/mast mounting and other components—including every nut and bolt—are checked and replaced as necessary.

Brakes

To ensure the safe operation of each Encore lift truck, we perform a complete brake overhaul that includes the replacement of cylinders, pads, rotors and fluids.

Hydraulics

During truck remanufacturing, the hydraulic system, filters, hydraulic oil, cylinders, packing, hoses and other worn hardware are replaced.

1-Year Warranty

Contact Your Local Crown Dealer Today
And Experience The Crown Difference.

crown.com



Crown Rental Program

Right Truck. Right Now.

Seasons change and your business needs can change with them. Whether you need a lift truck for a few days, or a few weeks, Crown has the right lift truck for the job.



FEATURED PRODUCTS



RM 6000
Narrow-Aisle Reach Truck



RR 5700
Narrow-Aisle Reach Truck



C-5
LPG Cushion



C-5
LPG Pneumatic



SC 5700
Three-Wheel Counterbalance



FC 5700
Four-Wheel Counterbalance

Call Today 1-877-RNT-LIFT
1-877-768-5438

**Contact Your Local Crown Dealer Today
And Experience The Crown Difference.**

crown.com



Maximize Value Minimize Downtime

By offering a variety of maintenance programs – each with optional services – your local Crown dealer can provide a maintenance solution that best fits your company’s individual needs.



Programs ▶	Time & Material	Planned	Full	Complete
Integrity Service System®	✓	✓	✓	✓
Integrity Parts System®	✓	✓	✓	✓
Truck PMs		✓	✓	✓
Periodic Maintenance			✓	✓
Wearable Components			✓	✓
Major Components			✓	✓
Side Shift Attachment Repair			✓	✓
Wheels and Tires				✓
Light Bulbs and Fuses				✓
Misuse or Abuse (\$500 or less)				✓
Detailed Service Reports	✓	✓	✓	✓
Customized Billing Cycle Options	✓	✓	✓	✓
Battery PMs* (Optional)		✓	✓	✓
Battery Repairs* (Optional)	✓	✓	✓	✓
Charger PMs* (Optional)		✓	✓	✓
Charger Repairs* (Optional)	✓	✓	✓	✓

*Note: Consult your Crown representative for details.

**Contact Your Local Crown Dealer Today
And Experience The Crown Difference.**



Nationwide, GPS-Tracked Service Fleet
4 hour or less response time



Minimum 40 Hours Training Per Year
Exceptional first time fix rate



Comprehensive, Tablet-Based Service Platform
Access to service history, warranty info and service manuals



Parts Availability
Over 90% at local location



Extensive Support Team
Advanced field support backed by a factory-based call center



Service Request App
Instant access to service from your mobile device



Long-Lasting Parts Lower Cost Of Ownership

Whether you're looking for parts for Crown forklifts or virtually any other brand, depend on Crown to provide only high quality parts built to last longer and maximize uptime. By reducing the frequency of parts replacement and unexpected downtime, you'll increase productivity, reduce cost and achieve lower cost of ownership.



**Contact Your Local Crown Dealer Today
And Experience The Crown Difference.**



Hundreds of Thousands of Parts for More Than 50 Material Handling Brands



Computerized Parts Inventory with Over 90% Local Availability



Nationwide Fleet of Service Vehicles Stocked with the Most Commonly Used Parts



On-Site Parts Consignment Program to Place Parts at Your Fingertips



Electronic Parts & Service Resource Tool (PSRT) Provides Online Parts Ordering



Detailed Parts Usage Analysis Helps Determine the Parts You Need Most



COLUMBIA

BUILT FOR WORK



Columbia Vehicle Group, is an electric vehicle manufacturer whose history dates back to 1946. Based in Reedsburg, Wisconsin, Columbia manufactures vehicles built for work in industrial and commercial environments. Designed to enhance productivity, comfort and utility, Columbia vehicles optimize operational performance in transporting, carrying, and towing - all with zero emissions.

Contact your local Crown Representative for specifications and pricing.



COLUMBIA

BUILT FOR WORK

COMPLETE SOLUTIONS

A complete solution for your application may include custom branding, additional safety features, special paint colors, fleet evaluation and long term management, or a custom engineered upfit geared toward making your job easier and more efficient.





PAYLOADER

- Up to 4000 lb. capacity
- Strongest frame in class
- Hydraulic brakes
- Ideal upfit platform



CHARIOT

- 14 gauge steel body
- 3 times faster than walking
- Fits through 30 inch doorway
- Best in class turning radius



EXPEDITER

- 14 gauge steel body
- Up to 750 lb. rated capacity
- Up to 2 passengers
- 3 or 4 wheel options



STOCKCHASER

- Up to 1200 lb. capacity
- Up to 6000 lb. towing
- Extremely maneuverable
- Best in class turning radius

c o l u m b i a v e h i c l e s . c o m



JOURNEYMAN 2XL

- Up to 2 passengers
- Up to 1,100 lb. capacity
- Indoor & outdoor operation
- Long bed



UTILITRUCK 2XL

- Up to 2 passengers
- Up to 1,250 lb. capacity
- Indoor & outdoor operation
- Long bed



JOURNEYMAN 2X

- Up to 2 passengers
- Up to 800 lb. capacity
- Indoor & outdoor operation
- Short bed



UTILITRUCK

- Up to 2 passengers
- Up to 1,500 lb. capacity
- Indoor & outdoor operation
- Shown with options



JOURNEYMAN 4X

- Up to 4 passengers
- Up to 1,100 lb. capacity
- Indoor & outdoor operation
- Short bed



UTILITRUCK

- Up to 2 passengers
- Up to 1,150 lb. capacity
- Indoor & outdoor operation
- Shown with options



Facility and Grounds Care Solutions

Tennant Company is a world leader in manufacturing sustainable cleaning solutions that help create a cleaner, safer, healthier world.

Its products include cleaning equipment for maintaining surfaces in industrial, commercial and outdoor environments; innovative chemical-free and other sustainable cleaning technologies such as ec-H2O™ Nano-Clean and Orbio®; and coatings for upgrading floor, wall, and parking deck surfaces.

Please contact your Crown representative for more information.



T1B Battery Walk-Behind Scrubber

- Micro-Scrubber
- Cord-free flexibility allows cleaning even when people are present
- Optional lithium-ion battery provides up to 20 hours longer battery life and can clean multiple times per day
- Compact, forward and reverse scrubbing and drying delivers best-in-class cleaning of congested spaces



S10 Walk-Behind Sweeper

- Sweeps tight and open spaces better than any other walk-behind sweeper available
- Increase productivity with the largest hopper of any walk-behind sweeper; holds up to 150 lb / 68 kg of debris
- Exceptional dust control protects facility and employees



5700 Walk-Behind Scrubber

- Industrial-Strength Floor Scrubber
- Superior cleaning performance from aggressive scrubbing system delivering up to 300 lbs. of down pressure
- Maximized machine longevity from industry-leading engineering and industrial-grade construction
- Just-scrubbed floors are clean, dry and safe for traffic in seconds with ec-H2O™ and FaST® technologies



T16 Rider Scrubber

- Battery-powered rider scrubber
- Achieve lower cost of ownership with Tennant's quality construction and innovative technologies
- Clean anytime, anywhere with the quiet T16 at 68 dBA
- Enhance productivity and safety with unparalleled user-friendly design and Touch-n-Go™ controls



T17 Rider-Scrubber

- High-Performing, Heavy-Duty, Battery Rider Scrubber
- Maximize your floor cleaning capacity in the harshest industrial locations
- Reduce slips and falls with water recovery system that leaves floors virtually dry
- Clean effectively with ec-H2O™ technology





S20 Rider Sweeper

- Compact in size, big on performance and durability
- Simple, easy-to-use controls reduce operator training with all levers-forward design
- Unrivaled dust control performance with the SweepMax® system and ShakeMax® 360 technology



Facility and Grounds Care Solutions

Tennant Company is a recognized leader of revolutionary cleaning equipment and technologies.

Focused on cleaning more of our customer's spaces more effectively, we are passionate about developing innovative and sustainable solutions to help our customers address their indoor and outdoor cleaning challenges.

Please contact your Crown representative for more information.



M30 Rider Scrubber-Sweeper

- Large Integrated Scrubber-Sweeper
- Superior results in just one pass – with FloorSmart® integrated cleaning system
- Lower Total Cost of Ownership™ without compromising safety or performance
- Maximum productivity with ec-H2O™ or FaST® technology for cleaning three times longer than conventional scrubbing methods



S30 Rider Scrubber

- Mid-Sized Rider Sweeper
- Provide excellent indoor and outdoor dust control with the SweepMax® Plus system
- Achieve consistent cleaning results in the toughest applications
- Deliver easy operation and maintenance while running at peak performance



Shown with optional cab



Operator Training The most important component is you

Safety in Your Application

We can help you in your effort to provide a safe and productive powered industrial lift truck work environment not only with equipment designed around your operator, but with training products and services for your operators, trainers, supervisors, technicians and even your workplace pedestrians.



- ▶ We have been setting the standard for years!
- ▶ Unmatched customer service, quality & value
- ▶ Highly interactive classes with extensive practical hands-on training provides higher retention rates, ensuring a safer workplace
- ▶ In-depth, custom tailored programs available at customer's location
- ▶ Seasoned instructors, qualified to train on all brands/types of equipment

Lift Truck Operator Training Programs

Part Number	Description
24500	It's Up to You (Required prerequisite to programs marked with *)
200135	*M Series Intermediate-Duty Walkie Stackers
200106	*PW 3000 Serie Walkie Pallet Trucks
200021	*PR 3000/4000 Series Rider Pallet Trucks
200030	*TWR/TR 3000-45000 Series
200027	*SH/SHR ST/SC WE/WS 2300 Series
200142	*RC 3000 Series Stand-Up Rider
200059	*TSP 6000 Series Turret Stockpickers
200112	*SC 4000/5000 Series Three Wheel Sit Down Lift Trucks
200062	Wave Work Assist Vehicle Program
200125	*WP 2300/3000 Series Walkie Pallet Trucks
200009	*FC 4000/4500 Series Four Wheel Sit Down Lift Trucks
200111	RC 5500 Series Stand_Up Rider
200016	IC Class IV and V
200055	RR/RM 5000-6000 Series Reach Trucks
200043	PC 4500 Series Rider Pallet Trucks
200125	WP 2300/3000 Series Walkie Pallet Trucks
200143	SP 3000/4000 Series Stockpickers
200068	RT 4000 Series
36002	PE 4000/4500 Series Rider Pallet Trucks
200069	MPC 3000 Series
43400	Pedestrian Safety
1539	Infolink for Operators
36700	LeadSafe Training for Supervisors

Infolink Training for Operators available



Ridg-U-Rak is one of the leading rack manufacturers in North America and is one of the founding members of the Rack Manufacturers Institute (RMI). Ridg-U-Rak provides selective and high-density storage racks, multi-level pick modules, drive-in, push-back, light-duty wide-span racks and specialized storage systems for manufacturing, warehousing, logistics and distribution operations. Ridg-U-Rak pallet racking is provided with a powder-coat finish for improved longevity and durability. Standard frame color is forest green. Standard beam color is safety orange.



UNARCO has the most diverse line of material handling storage options available, offering both structural and roll-formed pallet rack as well as numerous gravity flow options, including carton flow, pallet flow, and pushback rack. High density storage choices include cantilever, drive-in/drive-thru, and highly engineered pick modules. UNARCO interchangeable pallet rack can attach to other manufacturers' keyhole design rack to add to existing systems. Bolted or automatic locking devices connect to any rack system and change as your warehouse storage needs grow, providing an efficient and sturdy solution.



FEATURED SUPPLIERS



Rack Builders Inc. designs and manufactures structural storage solutions to suit the wide scope of needs that warehousing professionals have. Utilizing our wealth of engineering and fabricating experience, RBI has the solution to any warehousing problem. All of our systems - from selective rack to drive in rack to pick modules - feature damage-resistant design and industry-leading details. RBI pushback rack - including an industry-exclusive seven deep system - increases productivity and density, while reducing damage and overall life-cycle cost. From our centrally-located 160,000 square foot manufacturing plant, we ship large and small projects all across the United States and North America.



Pallet Runner Deep Lane Storage Provides:

- Increased Throughput
- Maximum Storage Density
- Unsurpassed Utilization
- Maximum Selectivity
- FIFO & LIFP Configuration
- Unlimited Lane Depth
- Reduction in Rack Damage
- Decreased Product Damage
- Capacity of 4,400 lbs.
- Increased Operator Productivity



Mallard is the leading resource for quality, engineered gravity flow storage products for manufacturing and distribution facilities worldwide. They handle projects of any size and scope, custom designed and manufactured for your unique application. And, they will even test your system to make sure it's the best design for your pallets, boxes or totes; all while staying within your budget. All of their Pallet Flow and Carton Flow systems provide high density storage for optimal space utilization, inventory control, labor efficiency and equipment savings.



BoxLogix has performed a broad spectrum of material handling projects across the United States. This includes projects throughout many different market types, from new green field state-of-the-art facilities to retrofits of existing facilities. We have developed tremendous industry partnerships to provide top of the line equipment and solutions customized to the needs of your project and we pride ourselves on outstanding customer service.



BHS, Inc. is a leading manufacturer of forklift battery handling and custom warehouse equipment based in St. Louis, MO. BHS tailors its industry-leading products to customer specifications, focusing on enhancing ergonomics and productivity while providing a complete set of solutions for clients in a variety of industries.





DECKING SOLUTIONS

The industry's most commonly requested accessories for pallet rack systems.

WIRE MESH CONTAINERS

Industrial wire mesh containers for distribution and manufacturing applications around the world.

PALLET RACK PROTECTION

Safeguard your pallet rack investment against the high cost of pallet rack damage.



At Nashville Wire Products, we turn wire into wonderful: Designed, engineered, and manufactured to take you further, go higher, store more, sell more, do more, and be more. Better, more honest construction. People you can trust and grow with. A true partner that delivers, on time, every time. Whether material handling products for the nation's warehouses or engineered components, we manufacture American-made products, with American-made quality, and American-made confidence.



FEATURED SUPPLIERS



Mighty Line® patented floor tape is the most durable floor tape available. Spend more time on value added actions – producing, receiving, and shipping materials – and less time on non-value added activities such as painting floor lines. Mighty Line floor tape is available in many colors and patterns in four different widths.



Magliner hand trucks are made with aluminum components for the highest strength-to-weight ratio in the industry. Lightweight trucks put less strain on users, reduce user fatigue, and lead to fewer injuries – and that means increased productivity.



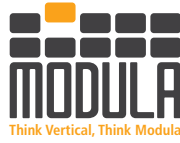

Lift your warehouse into the future with Modula.

Lack of space, inaccurate inventory, and inefficient workflows limit future possibilities. Modula's American-made automated storage solutions dramatically boost productivity and accuracy, reduce storage space and enhance worker safety and job satisfaction.

Get the lift you need today.

www.modula.com

FEATURED SUPPLIERS



Rousseau designs and manufactures professional-grade drawers, shelving and workstation systems, which are marketed primarily through our North American distribution network to companies operating in a variety of industries. Rousseau's various product lines scale to your specific needs and evolve as your business grows. Specialists are on hand to offer personalized solutions to address the storage and ergonomic challenges of your work environment. We are recognized as an industry leader for our creativity, expertise and continued dedication to developing innovative, differentiated, value-added products that are true solutions to our customers' requirements.



For over thirty years, Western Pacific Storage Solutions has established itself as a premier supplier and manufacturer of industrial shelving and work platforms (mezzanines) to some of the world's largest corporations. The company's operations in California, Texas and Kentucky include two state-of-the-art manufacturing plants, and three strategically-located distribution centers.



You can rely on Tensco's high-quality line of storage and industrial solutions to meet your needs. The broad product line includes shelving, bulk storage racks, work benches, packing tables, shop equipment, drawer units, cubbies and cell phone lockers.





A-WALL Building Systems by Warwick Products manufactures modular offices and in-plant buildings that are easy to install and relocate. They require fewer parts than comparable building systems and the electrical devices are factory-installed in the wall panels. This means your initial installation and future changes will require less time and cost.



Safety rails, headers, bollards and other safety equipment from Heartland Engineered Products are recognized throughout the industry for providing high quality, durable solutions delivered on time and on budget. Stairways and accessories are designed and fabricated to stand up to constant, daily abuse while providing the highest-quality personnel protection. Our structural steel platforms and mezzanines are designed to add valuable floor space and provide superior conveyor system support.



Wildeck products are "Made in the USA" and incorporate the highest standards of structural, mechanical, and electrical design for material handling and facility safety applications. Our team of employee-owners have the knowledge and industry experience to ensure that your projects run smoothly from concept to completion. With quality products tailored to your individual requirements, you'll receive a level of strength, durability, service and support you won't find anywhere else.



- GUARDS
- MEZZANINES
- LIFTS
- ACCESS



WireCrafters® is the nation's leading manufacturer of Wire Partitions, Wire Cages and Wire Machine Guarding Systems. Our woven and welded wire mesh systems are uniquely designed to your specific application utilizing stocked or custom components. WireCrafters® also manufactures pallet rack enclosures, including RackBack™, a wire mesh pallet rack safety system designed to keep your inventory secure and your employees safe from potential falling items. In addition to our full line of wire mesh products, WireCrafters® is also known for our tough and rugged GuardRail systems which are ideal for facility safety and protecting valuable equipment.

WireCrafters

FEATURED SUPPLIERS



Begin saving up to 90% on your lighting energy.

Green Light National is a leading Energy Services Company specializing in ROI prioritized lighting upgrades and retrofits. Green Light National specializes in LED Lighting solutions for warehouses, offices, roadways and building exteriors.



Since developing the first HVLS prototype in 1998, MacroAir continues to serve as the "engineers of air™", through a commitment to innovation and design of the most durable and cost-effective commercial ceiling fans on the market.



Tennant Company is a world leader in manufacturing sustainable cleaning solutions that help create a cleaner, safer, healthier world. Its products include cleaning equipment for maintaining surfaces in industrial, commercial and outdoor environments; innovative chemical-free and other sustainable cleaning technologies such as ec-H2O™ Nano-Clean and Orbio®; and coatings for upgrading floor, wall, and parking deck surfaces.



As a leading, global manufacturer of aerial lift equipment, Genie® aerial equipment, including S® telescopic, Z® articulating and TZ™ trailer-mounted boom lifts, GS™ slab scissor lifts, GTH™ telehandlers, aerial work platforms, material lifts and vertical mast lifts, is used in a variety of industries and applications worldwide. And, Genie jobsite support equipment, including Terex® and Genie light towers, as well as the Genie line of options and accessories, are designed to increase operators' productivity in the field.





Hunter Industrial & Commercial has the right fan for any building, any industry, and any need. Whether you own a warehouse, gym, airplane hangar, restaurant... you name it, Hunter Industrial & Commercial provides reliable, consistent airflow solutions. Partner with Hunter and rest assured knowing that your facility will remain safe, comfortable, and productive.



J-tec Industries is a custom designer, fabricator and manufacturer of material handling equipment, such as industrial carts (or dollies as they are commonly referred), warehouse equipment, shipping racks and more. Our own CarryMore® Tugger Cart System is a leading example in the industry of our design capabilities. Both center-steer and quad-steer versions of this industrial tugger cart (or mother cart) are available and allow for virtually unlimited customization and heavy weight capacities in the roller carts (or daughter carts) that ride on top.

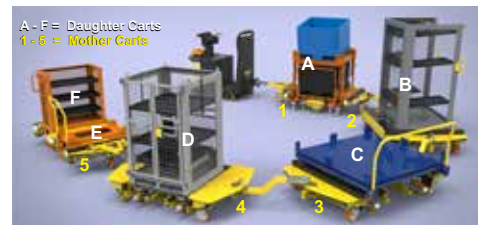

FEATURED SUPPLIERS



Since 1891, Nutting has been the premier manufacturer of high quality, engineered carts and trailers. Nutting's full line of products include lightweight order picking carts, heavy duty furniture picking carts, and heavy duty tracking trailers along with many more custom options available. Nutting's expert sales and engineering team will work with you to develop the safest and most efficient solution in the industry.

Tough – Cart and trailer solutions up to 100 Ton capacity
Durable – Built to the highest industry safety standards and quality
Dependable – Designed and manufactured in Watertown, SD



New Age specializes in "Build to Order" Order Picker and Ladder Cart solutions. Our Made in the USA aluminum products are fabricated to fit your exact needs. Unlike steel; Our primary grade aluminum extrusions ensure that our products are lightweight, heavy duty and will never rust - Increasing productivity and product longevity.





Dexco Industrial Storage products consist of heavy-duty structural racking systems engineered using the American Institute of Steel Construction (AISC) standards for buildings and bridges. Manufactured by Ross Industrial, all rack arms, bases, columns and shelves are fabricated using wide flange beams with a 50 KSI minimal yield to offer greater strength and durability compared to roll-formed and tube steel. Pre-drilled holes and heavy hex ASTM A325 bolts with oversized heads are provided to create fully adjustable rack arms and shelves.

dexco[®]
STRUCTURAL STEEL
I-BEAM RACKING SYSTEMS



WHEN DURABILITY MATTERS



Columbia's fleet of industrial and commercial vehicles are 100% electric and manufactured to increase productivity and utility, all while transporting, carrying and towing! Our full line of vehicles are designed to meet the demands of whatever environment your work requires and are truly Built for Work!

columbiavehicles.com



For handling long, bulky or heavy loads HUBTEX produces side loaders, multi-directional industrial trucks, compact forklifts and special vehicles. Innovative features, low maintenance technology, durability and high quality standards promise the reduction of operating and energy costs and guarantee an increase in efficiency during operation.

Hubtex also offers a large, comprehensive range of long and oversized load handling equipment. Lift trucks that are ideal for any industry application where long and bulky materials need to be moved through tight spaces inside and outside safely and efficiently.



Crown has 76 branch locations and 25 independent dealer locations to serve your needs nationwide.

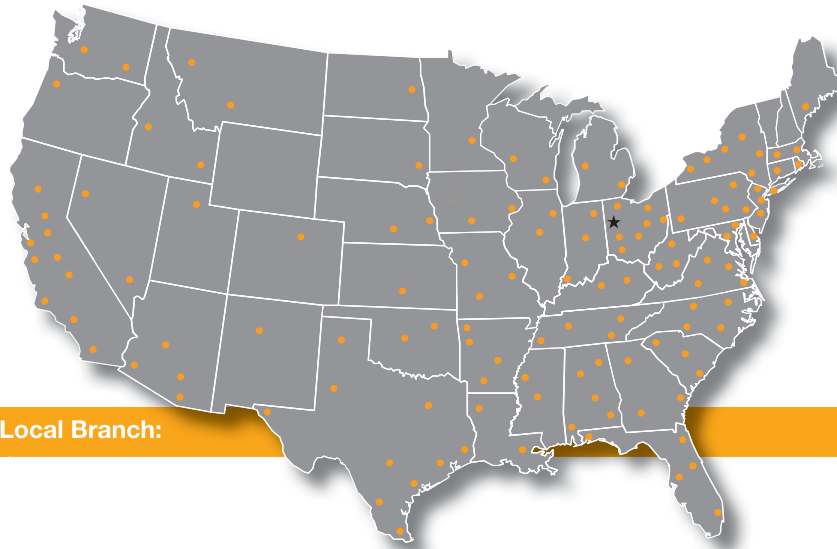

Contact Your Local Branch:

With 76 branch locations throughout the United States, and over 1,000 years of combined industry experience, Crown's Warehouse Solutions Team is not only one of the most professional choices to partner with for your storage solution needs, but one of the most knowledgeable. From sales coordinators to CAD designers to project managers, Crown has you covered with the most dedicated team in the industry to see to it that your operational goals are achieved. Communication and trust are pillars to developing the very best solution to YOUR specific operation. We will not present a specific product unless we determine it should be part of a specific solution that solves YOUR specific problem.



Professional Installation Services

- Local and National installation crews to handle any size project
- Dedicated project manager, no matter what size the project
- Our installers are required to meet all Crown insurance requirements
- Crown certified rental equipment on every project
- Your safety regulations are our safety regulations on every project

Need permit management assistance? We can help. From initial contact with your local building inspector to final project occupancy, Crown can help guide you through this sometimes challenging process.

Material Handling expertise.

Crown's real-world material handling expertise, along with a consultative business approach, distinguishes Crown as an industry leader; providing you the best offering of integrated material handling products and solutions.

Is your facility space at a premium? Could you save time and costs with more effective rack or shelving arrangements? How can you improve throughput? What tools would help your personnel work faster and more efficiently? How can you create a safer, more productive work environment?

Crown material handling specialists can help you find solutions that improve throughput, enhance efficiency and reduce costs. Our associations with quality manufacturers and suppliers ensure a comprehensive selection of material handling products. No matter what material handling challenges you face, Crown has the material handling expertise and resources to deliver solutions that give you a distinct advantage.

Our material handling specialists make dozens of calls each week partnering with customers across a broad range of industries. They evaluate and troubleshoot thousands of issues, helping businesses determine the best combination of products and resources for a customized solution. With their extensive training and experience, you can be assured they will work with you to find the most efficient solutions focused on your specific needs.

RACK & SHELVING



One of the most common material handling challenges is the need to maximize space. Of the many products on the market, which selection will provide the best results?

The Crown advantage comes from a focused, customized approach that meets your exact requirements. A careful analysis enables Crown material handling specialists to save you valuable square footage and reduce the time required to store and retrieve products.

Choosing the right rack system is one way to make a significant difference. Your local Crown branch can help you determine the ideal solution based on your individual needs and the benefits you wish to achieve.

If your application requires selectivity of product, you can maximize space by utilizing selective rack with the appropriate lift truck. You can also rely on Crown to help you maximize space by combining different types of rack, carton flow, conveyors, or pick modules specifically configured to meet your facility's needs.

You can also rely on Crown to help you maximize space with modular in-plant offices and mezzanines. Along with space savings, these solutions allow you to save on new construction costs while creating organized, efficient work areas.

With Crown, you'll benefit from a full range of solutions with the flexibility to choose products from quality manufacturers and suppliers based on your unique requirements.

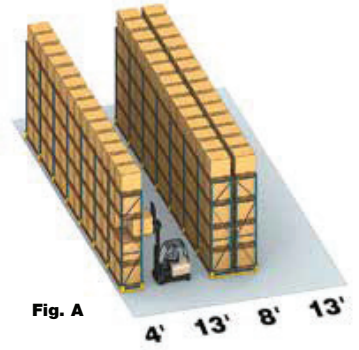

Fig. A

Selective Rack
Counterbalanced Lift Truck

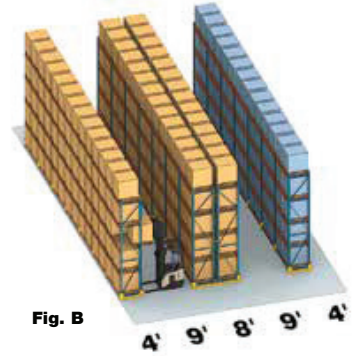

Fig. B

Selective Rack
Rider Reach Truck
33% more storage over Fig. A

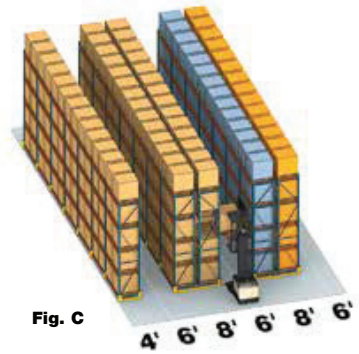

Fig. C

Selective Rack
Turret Stockpicker
25% more storage over Fig. B
66% more storage over Fig. A

Maximize space with a customized approach.



Push-Back Rack
First-in, last-out
Variable truck and aisle



Flow-Thru Rack
First-in, first-out
Variable truck and aisle

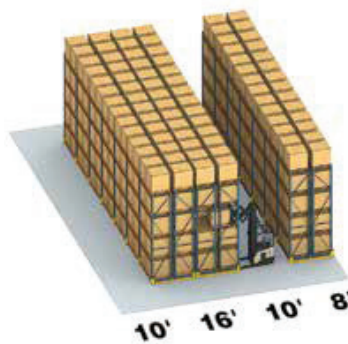

Double-Deep Rack
Double Reach Lift Truck
8.5'-11' aisle width

Many facilities install selective rack systems, while others choose rack systems integrating combinations of double-deep, drive-thru, cantilever, push-back, flow-thru racks and other options. The type of lift truck also determines how effectively you can maximize space and improve your material handling.

Counter-Balanced Layout

10.5' - 13' Aisle

In a typical counter-balanced application, the clear height is 30' or less. The lift height of the truck is usually 240" or less and the collapsed height of the truck allows the lift truck to enter a semi-trailer and stack the load directly into the rack system.

FC - COUNTER-BALANCED LAYOUT

32' CLEAR HEIGHT - 4 PALLETS HIGH, 1,230 BAYS OF RACK, 9,840 PALLET POSITIONS
BUILDING= 125,421 SQUARE FEET, 12.7 SQ. FT. PER PALLET POSITION



FRONT ELEVATION VIEW

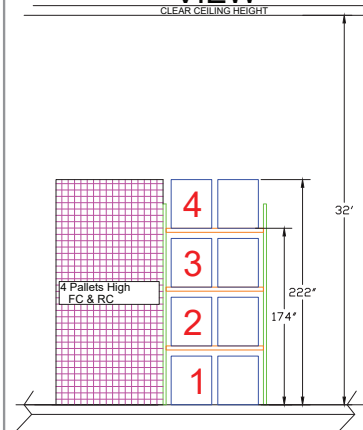

Counter-balanced lift truck applications usually require the lift to go into a trailer to retrieve the load and place it directly into the rack system. Thus, the lift height is restricted by the collapsed height of the mast required to enter into the trailer. Thus the lift height of the FC layout is limited to 4 pallets high.

RACK & SHELVING



Reach Truck Layout

Narrow Aisle 9'-10'

A reach truck can lift as high as 505" and is used with selective rack. The width of the aisle is dependent on the lift truck specifications and lift height, but a typical clear aisle is between 8' – 9'6".

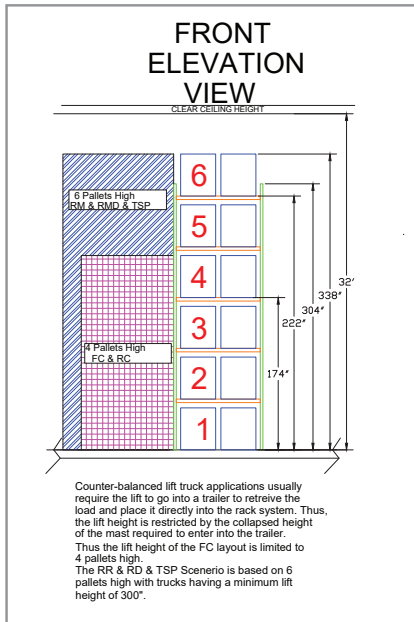

RM - REACH TRUCK LAYOUT
32' CLEAR HEIGHT - 6 PALLETS HIGH, 825 BAYS OF RACK, 9,900 PALLET POSITIONS
BUILDING= 71,820 SQUARE FEET, 7.3 SQ. FT. PER PALLET POSITION

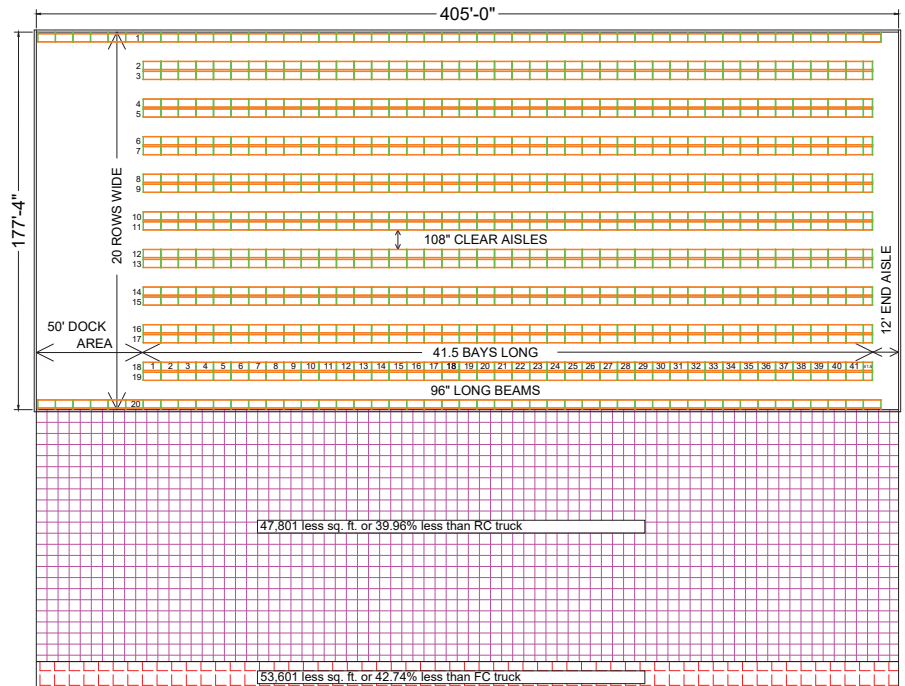

RACK & SHELVING

TSP Layout

VNA Aisle ~ 6'

TSP's are VNA (very narrow aisle) lift trucks. They can lift as high as 675" and can typically work in a clear aisle of 66" – 78". The truck is either wire guided or rail guided. The specifications of the truck, the load dimensions, the weight of the product, and the flatness of the floor help determine the clear aisle needed. The flatness of the floor plays a big factor in the design and performance of the TSP. F-min is a floor flatness rating used for define path trucks such as turret trucks and stockpickers. The turret truck is typically used with selective rack and provides good product density. The turret truck can also be used with push-back or flow rack to gain even more density.

RACK & SHELVING

TSP - TURRET TRUCK LAYOUT
 32' CLEAR HEIGHT - 6 PALLETS HIGH, 826 BAYS OF RACK, 9,912 PALLET POSITIONS
 BUILDING= 58,609 SQUARE FEET, 5.9 SQ. FT. PER PALLET POSITION

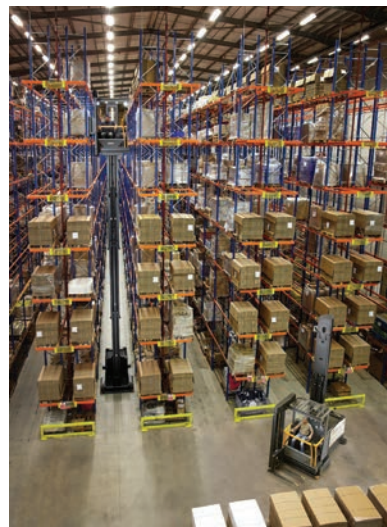
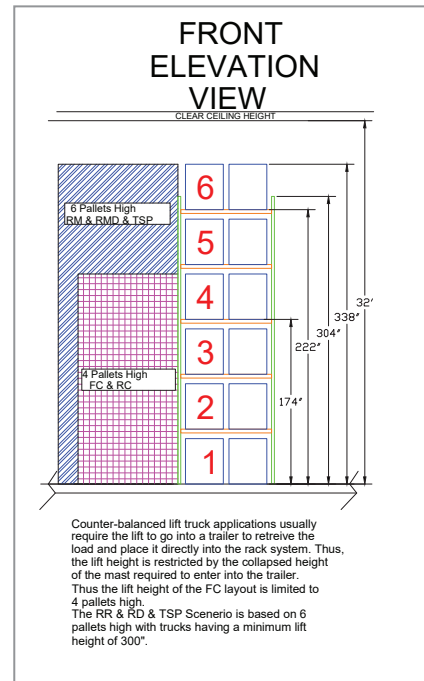
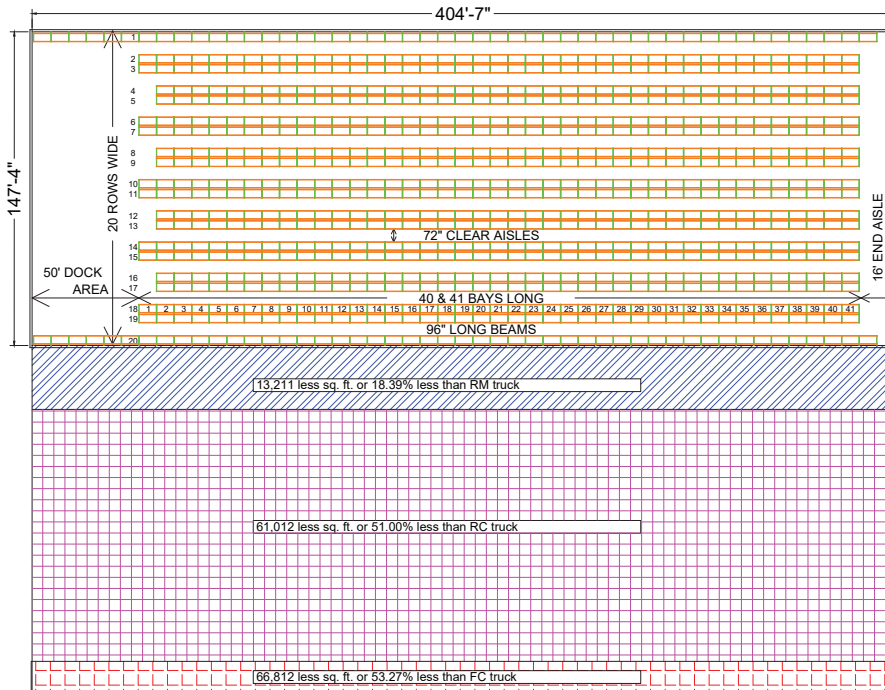

Deep Reach Layout

Aisle ~ 9.5' to 10.5'

Deep-reach trucks provide two deep product storage and is a good solution for LIFO (last-in, first-out) product rotation. A deep-reach truck can lift as high as 505". The outriggers of the truck must enter into the rack system so the design must accommodate the proper beam spacing. Since the deep-reach truck is placing pallets 2-deep into a rack system, the design will require more lift-off and will typically use wire decks or pallet supports (especially at higher lift heights) to aid in the placement of the loads.

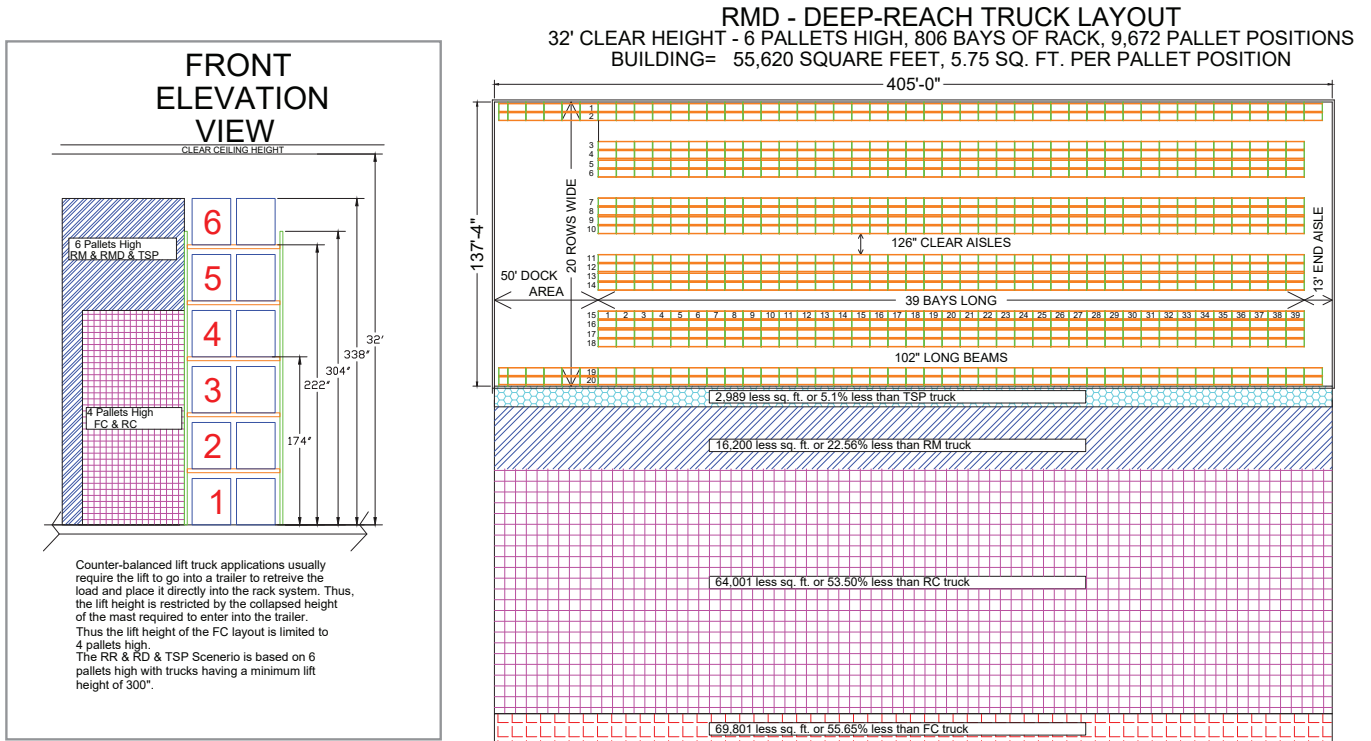

RACK & SHELVING





Rack Builders designs and manufactures high-quality, customer-focused structural rack systems — creating the ideal solution for your needs and reducing your overall cost of ownership.

- Selective Rack
- Drive In Rack
- Push Back Rack (2 to 6 deep)
- Pallet Flow Rack
- Picking Systems
- Specialty Rack
- Heavy Duty Rack Protection

- AWS certified digital welding
- Five-stage painting process
- Custom colors available

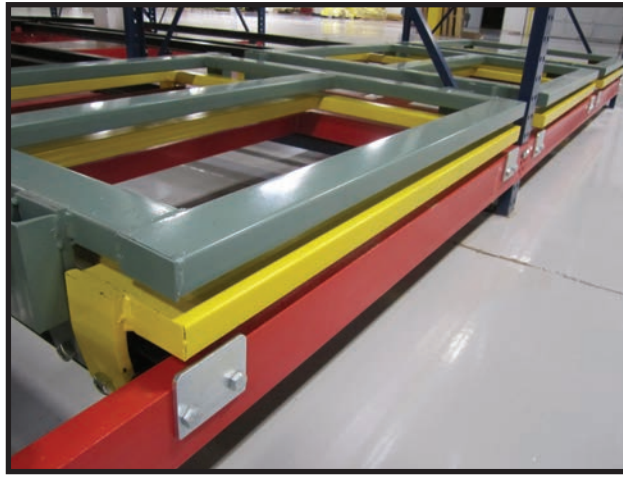

All RBI products are designed and manufactured to ensure quality and performance.

- Designed by licensed engineers to comply with applicable specifications
- High-strength structural steel from highly efficient mini-mills
- Certified welding utilizing digital welding technology
- High-strength hardware furnished by ISO 9001 suppliers
- Attractive, durable and environmentally-friendly painted finish (powder-coating also available)
- Two-year standard warranty



Please contact your local Crown dealer for layout design consulting and a quote.



- Additional pallet positions and the ability to use a shorter beam equates to an increase of bays of storage per row
- Increased efficiency & faster throughput as forklift operators do not need to avoid racking base plates & anchors
- Lower rack maintenance cost
- Lower forklift outrigger maintenance cost
- No need for post production (cost save on post protection materials and installation helps to offset the upgraded upright)

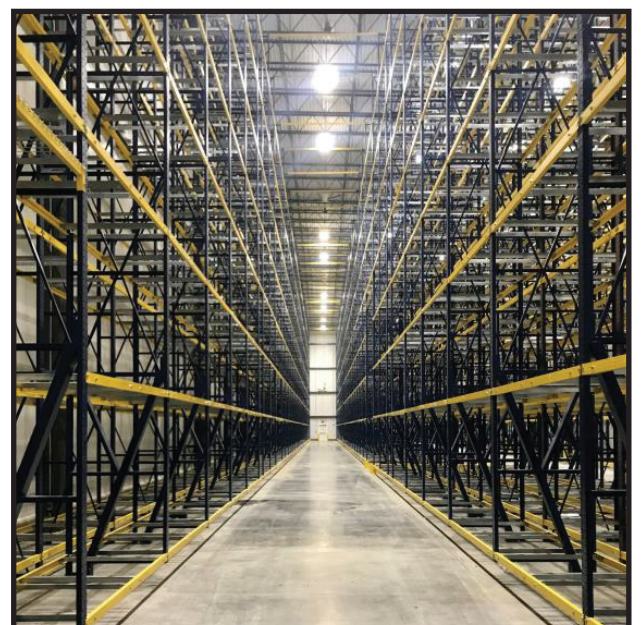
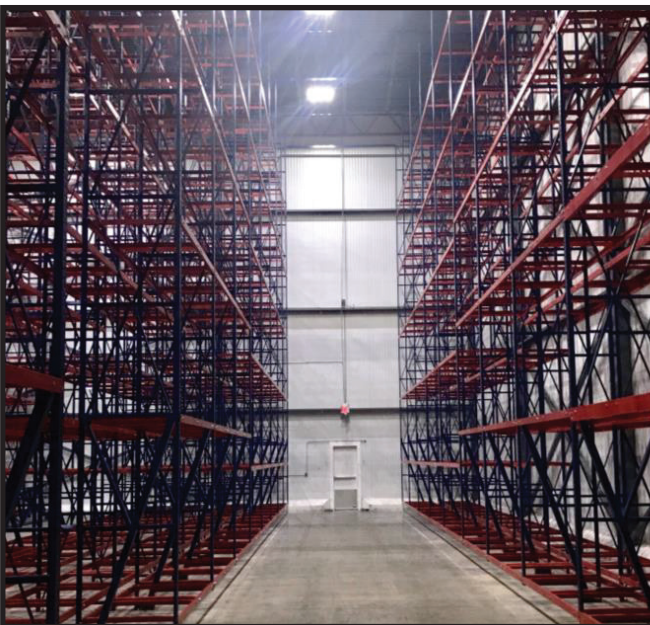
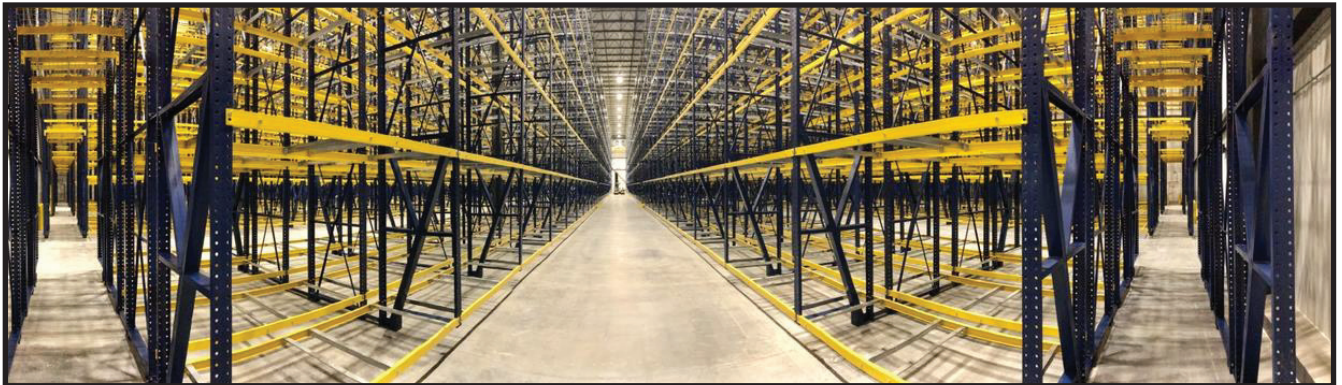
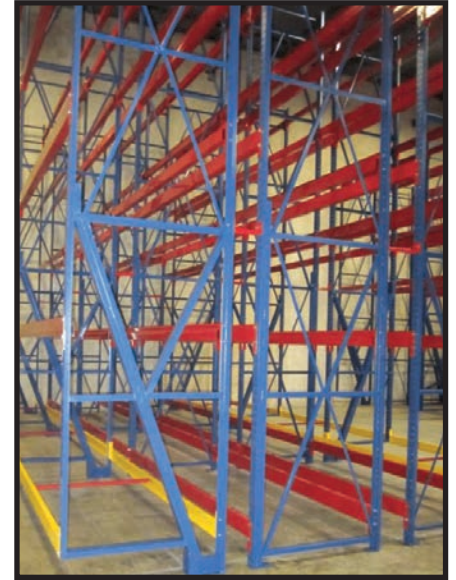

Ridg-U-Rak is one of the leading rack manufacturers in North America and is one of the founding members of the Rack Manufacturers Institute (RMI).

Ridg-U-Rak provides selective and high-density storage racks, multi-level pick modules, drive-in, push-back, light-duty wide-span racks and specialized storage systems for manufacturing, warehousing, logistics and distribution operations.

Ridg-U-Rak pallet racking is provided with a powder-coat finish for improved longevity and durability.

Standard frame color is forest green. Standard beam color is safety orange.

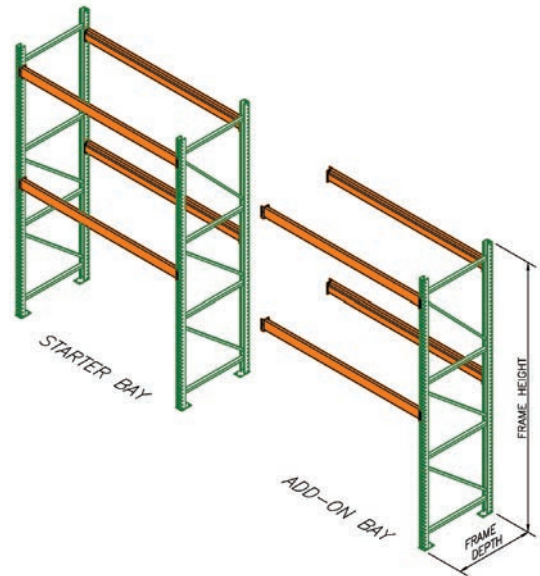

Teardrop Pallet Rack

36" Deep Frames

CAT. NO.	HEIGHT	CAPACITY (LBS.)*	LBS.
UF-S311-08.00-36.00A01-00-0100	96"	16,700	43
UF-S311-10.00-36.00A01-00-0100	120"	16,700	52
UF-S321-12.00-36.00A01-00-0100	144"	20,600	72

42" Deep Frames

CAT. NO.	HEIGHT	CAPACITY (LBS.)*	LBS.
UF-S311-08.00-42.00A01-00-0100	96"	16,700	45
UF-S311-10.00-42.00A01-00-0100	120"	16,700	55
UF-S321-12.00-42.00A01-00-0100	144"	20,600	75
UF-S331-12.00-42.00A01-00-0100	144"	25,100	84
UF-S331-14.00-42.00A01-00-0100	168"	25,100	96
UF-S321-16.00-42.00A01-00-0100	192"	20,600	99
UF-S331-16.00-42.00A01-00-0100	192"	25,100	111
UF-S331-20.00-42.00A01-00-0100	240"	25,100	135

48" Deep Frames

CAT. NO.	HEIGHT	CAPACITY (LBS.)*	LBS.
UF-S311-08.00-48.00A01-00-0100	96"	16,700	47
UF-S311-10.00-48.00A01-00-0100	120"	16,700	58
UF-S321-12.00-48.00A01-00-0100	144"	20,600	78
UF-S331-12.00-48.00A01-00-0100	144"	25,100	87
UF-S331-16.00-48.00A01-00-0100	192"	25,100	115

*Capacities (lbs.) based on 48" beam spacing, low-seismic application



Beams

CAT. NO.	LENGTH	HEIGHT	CAPACITY (LBS.)**	LBS.
RB-S321-250-048.000002-00-72-0	48"	2.5"	5700	12
RB-S321-355-096.000002-00-72-0	96"	3.5"	4070	26
RB-L321-410-096.000002-00-72-0	96"	4.1"	5010	25½
RB-S321-465-096.000002-00-72-0	96"	4.7"	7410	31
RB-S321-465-108.000002-00-72-0	108"	4.7"	6320	34
RB-S321-500-108.000002-00-72-0	108"	5.0"	7380	38
RB-S321-550-120.000002-00-73-0	120"	5.5"	7740	42
RB-S321-600-144.000002-00-73-0	144"	6.0"	6790	53

**Capacities are per pair of beams (lbs. uniform load), low-seismic application

SHIPPING INFORMATION: Call for Availability, F.O.B. North East, PA

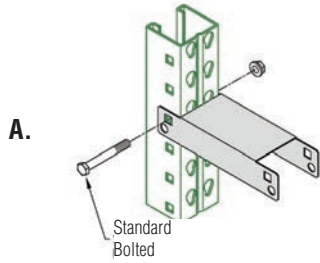

A. Row Spacers

- Price includes hardware, galvanized finish

CAT. NO.	LENGTH	LBS.
RS-L-3-006.00 13-0	6"	1
RS-L-3-008.00 13-0	8"	1
RS-L-3-012.00 13-0	12"	2

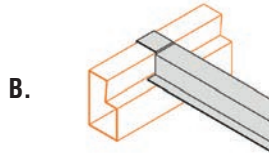

B. Flanged Cross Bars

- Galvanized finish

CAT. NO.	LENGTH	CAPACITY (LBS.)	LBS.
CBF-L-1-036.00 13-0	36"	1280	4
CBF-L-1-042.00 13-0	42"	1080	4
CBF-L-1-048.00 13-0	48"	930	5

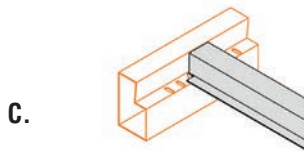

C. Tabbed Cross Bars

- Galvanized finish
- Must order beams with step punching option

CAT. NO.	LENGTH	CAPACITY (LBS.)	LBS.
CBU-L-1-036.00 13-0	36"	1280	3
CBU-L-1-042.00 13-0	42"	1080	4
CBU-L-1-048.00 13-0	48"	930	4

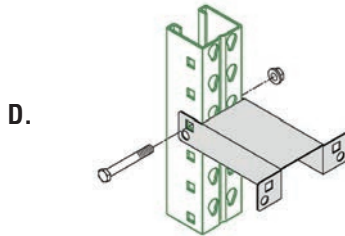

D. Wall Ties

- Price includes hardware, galvanized finish

CAT. NO.	BRACKET LENGTH	LBS.
RW-L-3-006.00 13-0	6"	1
RW-L-3-012.00 13-0	12"	2

SHIPPING INFORMATION: Call for Availability, F.O.B. North East, PA



Push Back Systems

- High Productivity
- Stock Rotations
- Lower Cost
- System Flexibility



Drive-In Systems

- Fewer Aisles
- Increased Storage Space
- Depth of System Unlimited



The Ridg-U-Rail 2000 is a roll-formed rail offering unparalleled strength and rigidity.



The Space Saver Rail saves vertical space when height is critical.





UNARCO Material Handling, Inc. was the first manufacturer of pallet rack in the United States. For over 50 years, they have helped define the material handling industry.

Teardrop frames are compatible with most industry interchangeable pallet racking. Patented locking devices for roll-formed beams provide the rigid connection needed to ensure safety.

- Uprights are painted deco green
- Beams are painted safety orange
- Beams adjust on 2" centers

Call Crown for pricing and availability.



Pallet Rack

Storage Rack Products

Product line offerings include both structural and roll-formed Pallet Rack, Carton Flow, Pallet Flow, Push-Back Rack, Cantilever, Drive-In/Drive-Thru and highly-engineered Pick Modules.

UNARCO also manufactures freezer racking applications, hybrid structural rack, mezzanines and RhinoTrac heavy-duty carton flow.

UNARCO offers a complete system solution.

Optional pallet rack accessories:

- Column Protectors
- Row Spacers
- Pallet Rack Crossbar Supports

Also available: Hybrid Pallet Rack — structural steel uprights with roll-formed beams for durability and affordability.

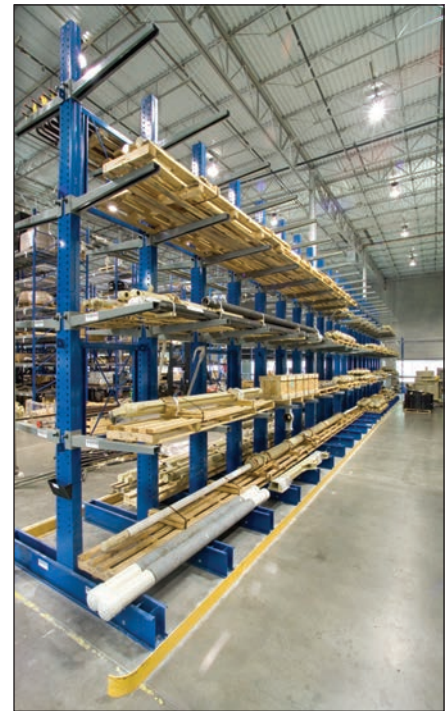

Cantilever Rack



Drive-In Rack



Push-Back Rack

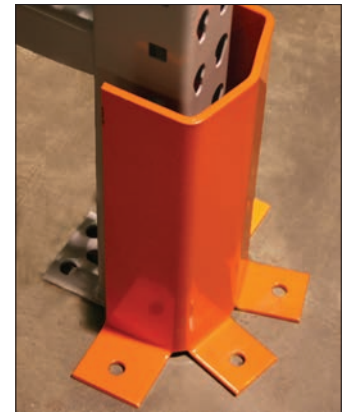

Floor Mounted Column Protector



Bolt-On Straddle Protector

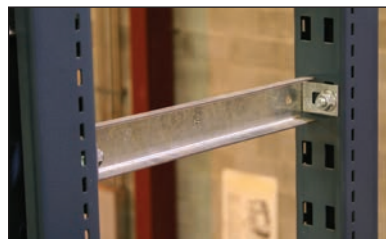

Row Spacer

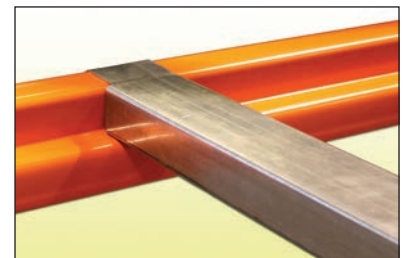

Pallet Rack Crossbar Support



PALLET RACKING

The stow Pal Rack® system consists of a full range of basic components and accessories to fulfill all of your requirements. The system is designed for the optimised storage of goods of all sizes and weights. All components have been thoroughly tested in specialised laboratories to determine their mechanical properties. These are used to calculate the safe load capacity of each component and ensure that they meet the stringent requirements of the FEM and RMI code for pallet racking.

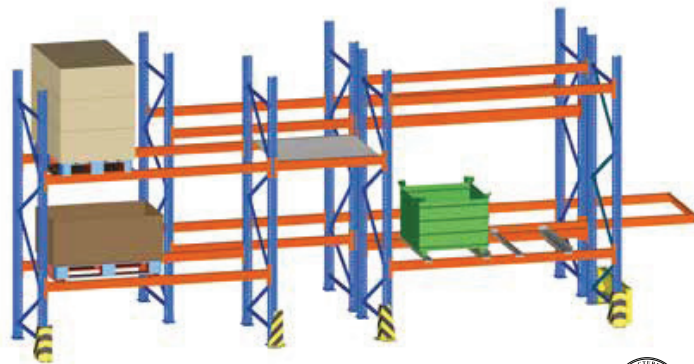

NUCOR®

WAREHOUSE SYSTEMS

TUBERACK

SMARTER. SAFER. STRONGER.

TubeRack Already Complies with Even the Most Recent Codes, Allowing Its Superior Design to Save Time, Cost and Hassle Without the Need to Retrofit.

TUBERACK BENEFITS



STRONGER.SAFER. SMARTER.

TubeRack's A500 Grade-B structural tubing design utilizes the same structural tubing used in building columns and bridges, and provides up to twice the straightness tolerances of structural channel as defined by ASTM specifications.



SAFETY ABOVE ALL

Our design significantly lowers the potential of product shed in a seismic or impact event. The 1/2" Grade 5, bolted connections eliminate the potential of a broken horizontal or diagonal brace going undetected in a typical existing racking system.



IMPACT RESISTANT

Up to 1/4" thick welded shapes with dimensions up to 5" x 3" providing the highest impact resistance in the business.



SHIPPING COSTS

TubeRack allows for maximum weight over cube, providing an average 35% savings in shipping costs.



MODULAR DESIGN

TubeRack provides a modular design making racking configuration changes or repairs simple and extremely cost effective. Both height and depth of the design can be altered affordably and with little effect on ongoing operations.



SEISMIC FORCE DEMAND TO INCREASE BY MORE THAN 50%



RMI BUILDING CODES ARE STRICTER THAN EVER

Nucor Warehouse Systems' TubeRack Already Meets the Requirements

Largest Pallet Rack Manufacturer in North America



Platforms



Cantilever

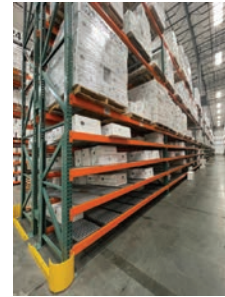

**Carton
 Flow**



Hybrid

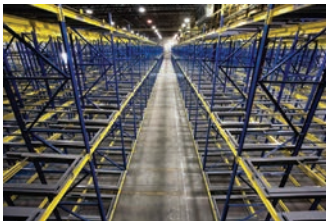

Pushback



Structural

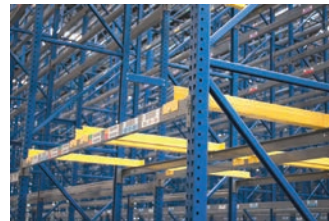

Roll Form



Drive In

Crown Equipment is one of our longest and strongest partnerships since we entered the material handling industry as Hannibal Industries more than 25 years ago.



Pallet Rack

Interlake Mecalux, the largest rack manufacturer in the Americas, has set the quality and design standards in the rack industry for decades. The welded frame design features a patented keyhole and wedge stud connection, with strength and flexibility unsurpassed in the industry. While there are many look-alike products on the market, no competitor has been able to reproduce the unique wedge stud that provides optimal strength, safety and support.

- Uprights are painted vista green.
- Beams are painted safety orange.
- Beams adjust on 2" centers.

SHIPPING INFORMATION:
1-2 Days, F.O.B. Cincinnati, OH

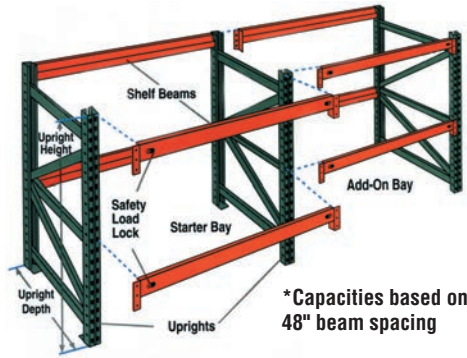

24" Deep Uprights*

CAT. NO.	HEIGHT	CAPACITY (LBS.)	LBS.
IE02509624	96"	19,300	38
IE02512024	120"	19,300	48

36" Deep Uprights*

CAT. NO.	HEIGHT	CAPACITY (LBS.)	LBS.
IE02509636	96"	19,300	43
IE02512036	120"	19,300	54
IE07014436	144"	23,000	67
IE07019236	192"	23,000	90

42" Deep Uprights*

CAT. NO.	HEIGHT	CAPACITY (LBS.)	LBS.
IE02509642	96"	19,300	46
IE02512042	120"	19,300	56
IE07014442	144"	23,000	71
IE07016842	168"	23,000	82
IE07019242	192"	23,000	93
IE07521642	216"	30,600	124
IE07524042	240"	30,600	137

48" Deep Uprights*

CAT. NO.	HEIGHT	CAPACITY (LBS.)	LBS.
IE02509648	96"	19,300	48
IE02512048	120"	19,300	59
IE07014448	144"	23,000	73
IE07016848	168"	23,000	85
IE07019248	192"	23,000	95
IE07524048	240"	23,000	140

4, 8, 9, 10 or 12-Foot Long Beams

CAT. NO.	LENGTH	CAPACITY/PAIR (LBS.)	LBS.
IB36E-48"	48"	8510	12
IB36E-96"	96"	4120	23
IB45E-96"	96"	6036	26
IB40E-108"	108"	4046	27
IB50E-108"	108"	6324	31
IB50E-120"	120"	5615	34
IB59E-144"	144"	5233	46
IB65E-144"	144"	6669	49

SHIPPING INFORMATION: 1-2 Days, F.O.B. Cincinnati, OH
(\$250.00 Minimum Order Requirement)



A.

A. Front-to-Back Support

Permits pallets to be placed on rack, prevents them from falling through.

CAT. NO.	DEPTH	CAPACITY (LBS.)	LBS.
IA004B036	36"	1350	4
IA004B042	42"	1130	5
IA004B048	48"	970	6

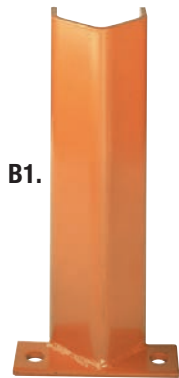

B1.



B2.

B. Impact Support Column Protector

Extra protection against abuse by mobile equipment.

B1. Separate Bolt-on with 2 Hole Lagplate

CAT. NO.	COLOR	HEIGHT	LBS.
IA57224	Orange	24"	11

B2. Floor Mount 4 Hole Lagplate

CAT. NO.	COLOR	HEIGHT	LBS.
IA570012	Yellow	12"	11

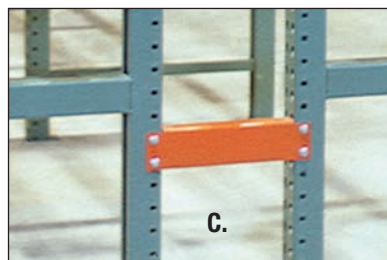

C.

C. Row Spacer

Maintains desired space between two back-to-back rows of racks. Two back-to-back ties are recommended for each pair of uprights.

CAT. NO.	LENGTH	LBS.
IA501S00600	6"	1
IA501S01200	12"	2
IA501S01800	18"	3
IA501S02400	24"	4

Pallet Runner Deep Lane Storage

Provides:

- Increased Throughput
- Maximum Storage Density
- Unsurpassed Utilization
- Maximum Selectivity
- FIFO & LIFO Configuration
- Unlimited Lane Depth
- Reduction in Rack Damage
- Decreased Product Damage
- Capacity of 4,400 lbs.
- Increased Operator Productivity



BOXLOGIX AUTOMATION

Looking to Automate your Warehouse or Distribution Operations?

Diagnose - Design - Deliver

BoxLogix is a full-service material handling system integrator. We service all North America and specialize in B2B, Direct to Consumer, Post/Parcel and Retail distribution concepts, technologies and installations to include but not limited to:

- Carton and Pallet Conveyance
- Pick Modules, AS/RS (unit-load & mini-load) & Goods to Person Solutions
- High Speed Sortation & Palletization
- Print and Apply, High Speed Weigh-in-Motion Scales & DIM Solutions
- Robotics (picking and palletizing), Voice & RF
- Preventative Maintenance

BoxLogix has performed a broad spectrum of material handling projects across the United States. This includes projects throughout many different market types, from new green field state-of-the-art facilities to retrofits of existing facilities. We have developed tremendous industry partnerships to provide top of the line equipment and solutions customized to the needs of your project and we pride ourselves on outstanding customer service.

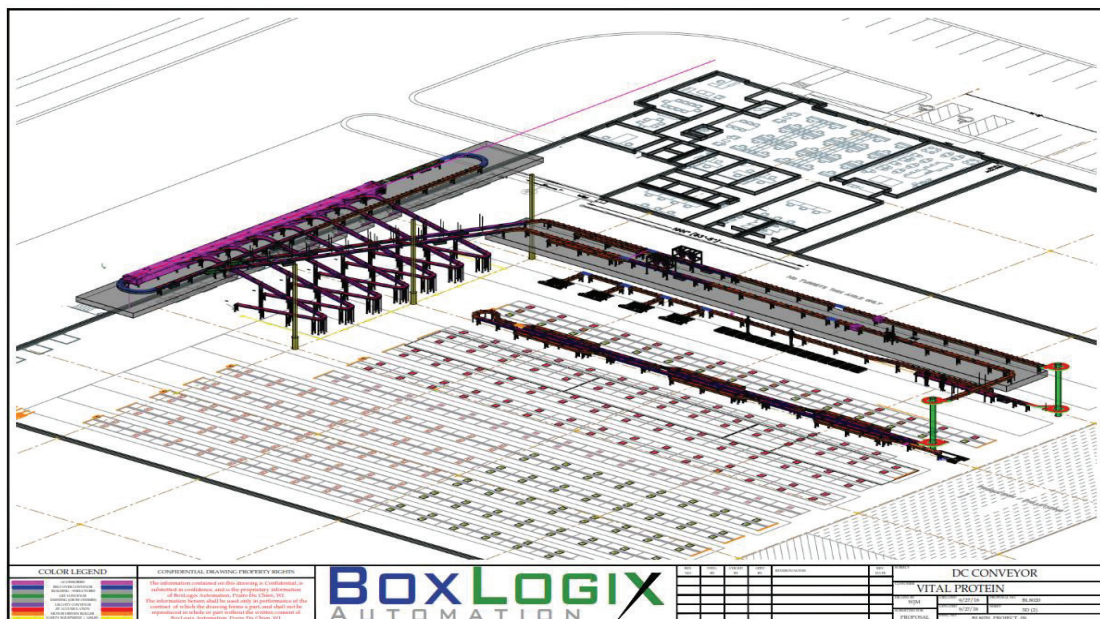

BOXLOGIX AUTOMATION

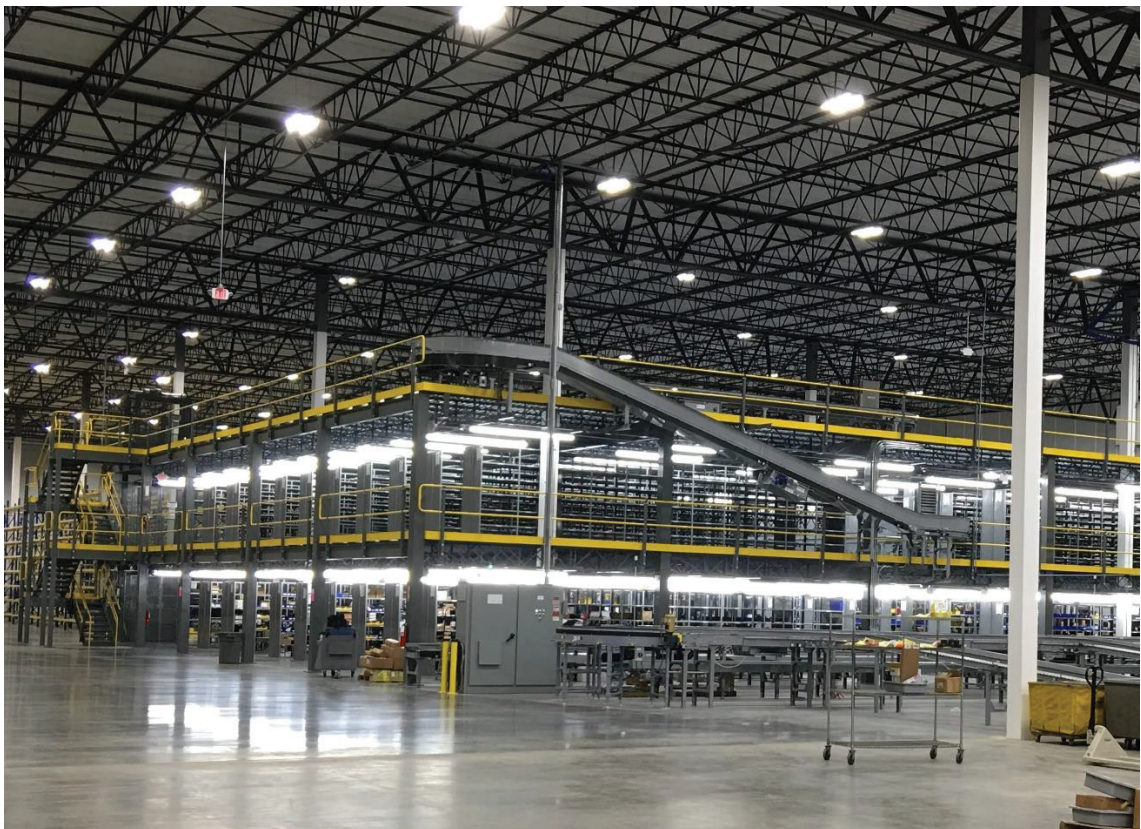

RACK & SHELVING

WAREHOUSE RACKING SOLUTIONS DESIGNED FOR SAFETY, DURABILITY, AND MAXIMUM EFFICIENCY



Dexco Industrial Storage products consist of heavy-duty structural racking systems engineered using the American Institute of Steel Construction (AISC) standards for buildings and bridges. **Manufactured by Ross Industrial, all rack arms, bases, columns and shelves are fabricated using wide flange beams with a 50 KSI minimal yield to offer greater strength and durability compared to roll-formed and tube steel.** Pre-drilled holes and heavy hex ASTM A325 bolts with oversized heads are provided to create fully adjustable rack arms and shelves.

RACK & SHELVING

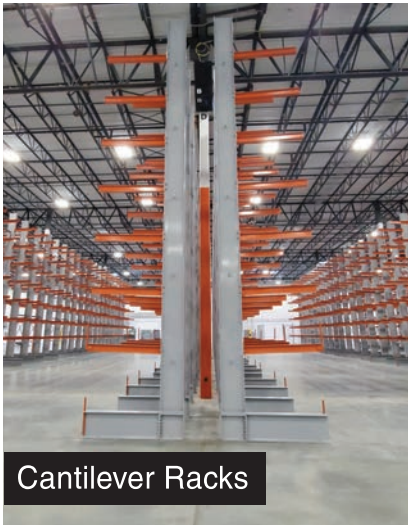

Cantilever Racks

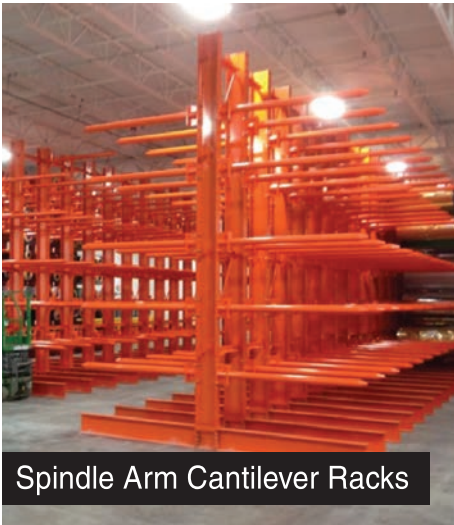

Spindle Arm Cantilever Racks

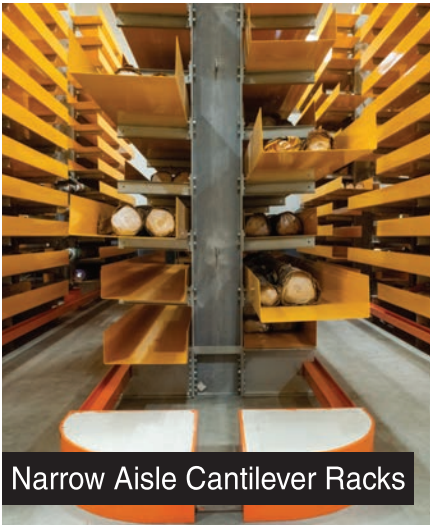

Narrow Aisle Cantilever Racks

Manufactured by



WAREHOUSE RACKING SOLUTIONS DESIGNED FOR SAFETY, DURABILITY, AND MAXIMUM EFFICIENCY

Engineered to safely meet almost any weight requirement, Dexco Racks are ideal for storing industrial materials such as lumber, coils, dies, pipe, tubing, plate, sheet metal and film. Typical cantilever systems support loads ranging from 1,000 pounds to 20,000 pounds per individual rack arm. Coil and die racks commonly support loads ranging from 2,000 pounds to 80,000 pounds per shelf. Engineered designs for higher load requirements are also available.



Die Racks

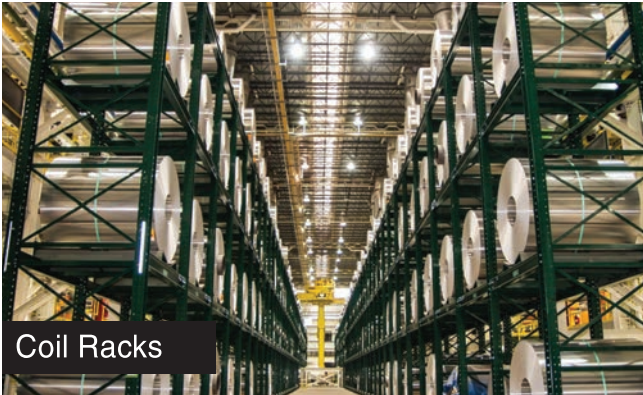

Coil Racks

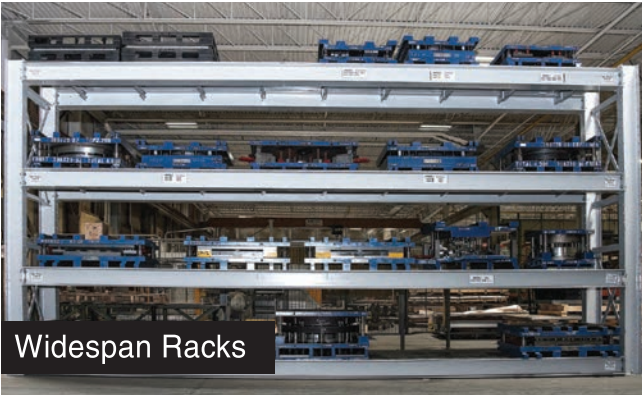

Widespan Racks

RACK & SHELVING

“ CONTACT YOUR CROWN REP FOR OUR FREE DESIGN GUIDE ”



Stanchion Racks

Founded in 1962, Ross custom engineers and manufactures Dexco Racks in Leola, Pennsylvania and ships product throughout the United States, Canada and Mexico.

Manufactured by



HUBTEX.

For Handling Long, Bulky or Heavy Loads

HUBTEX produces siders, multidirectional industrial trucks, compact forklifts and special vehicles. Innovative features, low-maintenance technology, durability and high quality standards promise the reduction of operating and energy costs and guarantee an increase in efficiency during operation.

Please contact your local Crown representative for more information.

Trucks for a Wide Range of Industries

Hubtex offers a large, comprehensive range of long and oversized load handling equipment. Lift trucks that are ideal for any industry application where long and bulky materials need to be moved through tight spaces inside and outside safely and efficiently.



MAXX - up to 9,900 lbs | up to 295" lift height



XENIUS - up to 12,000 lbs | up to 360" lift height



FLUX - up to 8,800 lbs | up to 295" lift height



DIE HANDLER - up to 66,000 lbs

RACK & SHELVING

BAUMANN 2-WAY SIDELOADERS

Baumann is a world-class manufacturer of electric and diesel side-loaders from 6,000 to 130,000 lbs capacity with a reputation for handling the most difficult challenges.

Please contact your local Crown representative for specifications and pricing.

CAVAION SIDELOADERS
BAUMANN



GX/GXS DIESEL
Capacities to 110,000 lbs



EHX ELECTRIC
Capacities to 11,000 lbs



GX DIESEL
Capacities to 44,000 lbs



GX DIESEL
Capacities to 17,600 lbs



EGX ELECTRIC
Capacities to 17,500 lbs



HX DIESEL
Capacities to 11,000 lbs

RACK & SHELVING

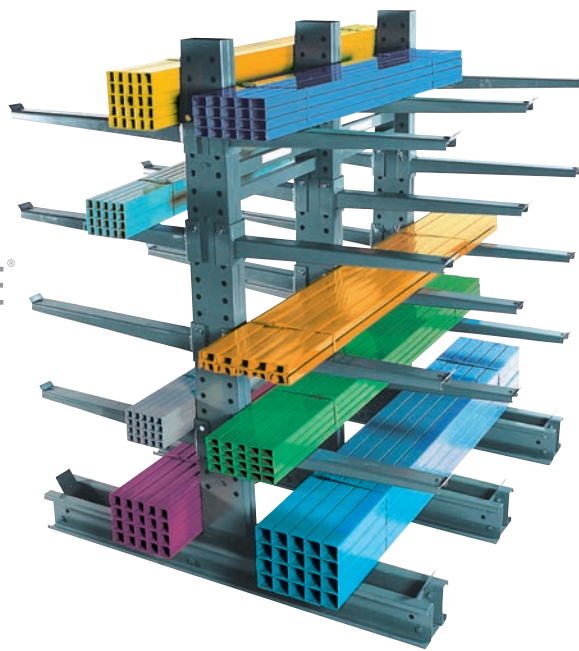

Steeltree 25 Series Cantilever Racks

The Steeltree Heavy Duty is for storing large amounts of heavy materials in a compact area.

Steeltree is an excellent option for handling awkward or extremely heavy stock with a fork lift. Ideal for bar and tube stocks and sheet material. Units assemble as a single rack or a continuous assembly of multiple racks to handle longer materials.

Standard features & benefits:

- 800 lbs. to 3,000 lbs. capacity per arm
- Tapered column design compensates for deflection ($\frac{1}{8}$ " per foot)
- Double tube bracing
- Sold as units or as component parts
- Single and double sided racks in four column heights: 8', 10', 12', 15'
- Straight or inclined arms in lengths from 12" to 60"
- Arms adjust on 3" centers. Removable lips on the ends are available
- Assembly is quick & easy no special tools needed

SHIPPING INFORMATION:
10 Days, F.O.B. Freeport, IL

Single-Sided Uprights

CAT. NO.	CAPACITY (LBS.)	HEIGHT	BASE	ARMS USED	LBS.
25CS31096	18520	8'	34"	12"	183
25CS31096	14950	8'	34"	18"	183
25CS37096	12530	8'	40"	24"	191
25CS46096	10780	8'	49"	30"	211
25CS46096	9460	8'	49"	36"	211
25CS58096	8430	8'	61"	42"	221
25CS58096	7600	8'	61"	48"	221
25CS31120	25650	10'	34"	12"	201
25CS31120	20640	10'	34"	18"	201
25CS37120	16860	10'	40"	24"	209
25CS46120	14250	10'	49"	30"	229
25CS46120	12340	10'	49"	36"	229
25CS58120	10880	10'	61"	42"	239
25CS58120	9730	10'	61"	48"	239
25CS31144	26300	12'	34"	12"	233
25CS31144	20450	12'	34"	18"	233
25CS37144	16730	12'	40"	24"	241
25CS46144	14160	12'	49"	30"	261
25CS46144	12270	12'	49"	36"	261
25CS58144	10830	12'	61"	42"	271
25CS58144	9690	12'	61"	48"	271
25CS37180	16540	15'	40"	24"	371
25CS46180	14020	15'	49"	30"	385
25CS46180	12170	15'	49"	36"	385
25CS58180	10750	15'	61"	42"	402
25CS58180	9620	15'	61"	48"	402

Double-Sided Uprights

CAT. NO.	CAPACITY (LBS.)	HEIGHT	BASE	ARMS USED	LBS.
25CD53096	18520	8'	53"	12"	210
25CD53096	14950	8'	53"	18"	210
25CD65096	12530	8'	65"	24"	236
25CD82096	10780	8'	82"	30"	252
25CD82096	9460	8'	82"	36"	252
25CD106096	8430	8'	106"	42"	292
25CD106096	7600	8'	106"	48"	292
25CD53120	25650	10'	53"	12"	228
25CD53120	20640	10'	53"	18"	228
25CD65144	16860	10'	65"	24"	254
25CD82120	14250	10'	82"	30"	270
25CD82120	12340	10'	82"	36"	270
25CD106120	10880	10'	106"	42"	310
25CD106120	9730	10'	106"	48"	310
25CD53144	26300	12'	53"	12"	260
25CD53144	20450	12'	53"	18"	260
25CD65144	16730	12'	65"	24"	286
25CD82144	14160	12'	82"	30"	302
25CD82144	12270	12'	82"	36"	302
25CD106144	10830	12'	106"	42"	342
25CD106144	10831	12'	106"	42"	342
25CD82180	14020	15'	82"	30"	438
25CD82180	12170	15'	82"	36"	438
25CD106180	10750	15'	106"	42"	473
25CD106180	9620	15'	106"	48"	473

Straight Arms

W/LIP CAT. NO.	W/O LIP CAT. NO.	CAPACITY (LBS.)	LENGTH	LBS.
25ASL12	25ASO12	3300	12"	11
25ASL18	25ASO18	2500	18"	13
25ASL24	25ASO24	2000	24"	15
25ASL30	25ASO30	1600	30"	17
25ASL42	25ASO42	1145	42"	22
25ASL48	25ASO48	1000	48"	24

Inclined Arms

W/LIP CAT. NO.	W/O LIP CAT. NO.	CAPACITY (LBS.)	LENGTH	LBS.
25AIL12	25AI012	3300	12"	11
25AIL18	25AI018	2500	18"	13
25AIL24	25AI024	2000	24"	15

Braces for 8' Uprights (Set of 2)

CAT. NO.	LENGTH*	LBS.
25B2036	36"	36
25B2048	48"	45
25B2060	60"	55
25B2072	72"	65
25B2096	96"	82

Braces for 10'-14' Uprights (Set of 3)

CAT. NO.	LENGTH*	LBS.
25B3036	36"	36
25B3048	48"	45
25B3060	60"	55
25B3072	72"	65
25B3096	96"	82

*Length of braces is measured from center of upright to center of upright.

A. U-Racks

- 6000 lbs. or 10,000 lbs. capacity per pair
- Stacks up to 4 levels high, with nesting flanges trapping unit above
- All-welded construction, no tools needed for assembly
- Lightweight construction, one person set-up
- Ideally suited for changing storage requirements
- Finished in high visibility orange powder coat

CAT. NO.	STACKING CAP. (LBS.)	INSIDE DIMENSION BASE		LBS.
		W X TOP	W X H	
ULD-06	6000	16½" x 25¼"	15¾"	25
ULD-10	10,000	17½" x 25¼"	15¾"	30



B. Bar Storage Racks

Horizontal:

- 1800 lb. load capacity per unit
- Use as an island of storage or as a continuous row
- 9 arm levels extend 9" on 6" spacing
- Rack is 84" high with a 30" x 30" base that tapers upward
- Individually packaged and ships unassembled (KD)
- Painted gray

Vertical:

- 3000 lb. load capacity per unit
- Use as an island of storage or as a continuous row
- Stores long material up to 12' long
- Shelves are 12 gauge steel
- Individually Packaged and ships unassembled (KD)
- Painted gray

CAT. NO.	H X L X D	CAP. (LBS.)	LBS.
CR-833	84" x 30" x 30"	1800	105
CR-834	84" x 36" x 24"	3000	110



CR-833
Horizontal



CR-834
Vertical

C. Reel Racks

- 2000 lb. load capacity per level with 10,000 lbs. maximum capacity per rack
- Provides quick uncluttered access
- Comes standard with 4 sets of rack axle brackets, which accept axles up to 2" diameter
- Axle brackets adjust on 2" center
- 24" maximum reel dimension

STARTER UNITS

CAT. NO.	W X D X H	MAX. REE WIDTH	LBS.
RR242496	24" x 24" x 96"	24"	236
RR362496	36" x 24" x 96"	24"	252
RR482496	48" x 24" x 96"	24"	268
RR243696	24" x 36" x 96"	24"	254
RR363696	36" x 36" x 96"	24"	270
RR483696	48" x 36" x 96"	24"	286
RR2424120	24" x 24" x 120"	24"	269
RR3624120	36" x 24" x 120"	24"	285
RR4824120	48" x 24" x 120"	24"	301
RR4836120	48" x 36" x 120"	24"	321
RRAXB	Axle Brackets (1 set)		

ADD-ON UNITS

CAT. NO.	W X D X H	MAX. REE WIDTH	LBS.
RA242496	24" x 24" x 96"	24"	149
RA362496	36" x 24" x 96"	24"	165
RA482496	48" x 24" x 96"	24"	181
RA243696	24" x 36" x 96"	24"	158
RA363696	36" x 36" x 96"	24"	174
RA483696	48" x 36" x 96"	24"	190
RA2424120	24" x 24" x 120"	24"	165
RA3624120	36" x 24" x 120"	24"	181
RA3636120	36" x 36" x 120"	24"	191
RA4836120	48" x 36" x 120"	24"	207

U-Racks

Low-cost storage for long, unwieldy materials.

Bar Storage Racks

Horizontal Bar Rack is a terrific option for storing angles, bars, and pipes up to 10' long. Additional units could be positioned to accommodate items longer than 10' with two or more units.

Vertical Bar Rack has all-welded steel components that bolt together for quick and easy assembly, creating a rack that stores long material vertically. Arms extend 6" beyond shelves creating divided storage. Four separate shelf levels allow for storage of smaller lengths and drops in same bay. Use in tool rooms, maintenance areas, machine centers, storage areas and point-of-purchase displays.

Reel Racks

Convenient upright rack storage for multiple sized reels.

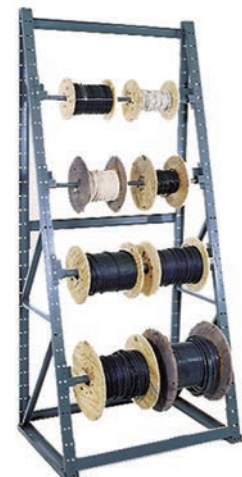

SHIPPING INFORMATION:
10 Days, F.O.B. Freeport, IL

Dyna-Flo

The Most Flexible Drop-In Carton Flow System Available

- Easy to handle drop-in sections of gravity flow wheeled conveyor to convert static pallet rack into a productive flow system.
- Easily configures for different carton sizes.
- Mix and match section widths (12" & 16") to fully fit beam width.
- Capacities shown are with no intermediate support.
- Attachment brackets for behind-the-beam mounting provides low profile.
- No reconfiguration required when box sizes or SKUs change.

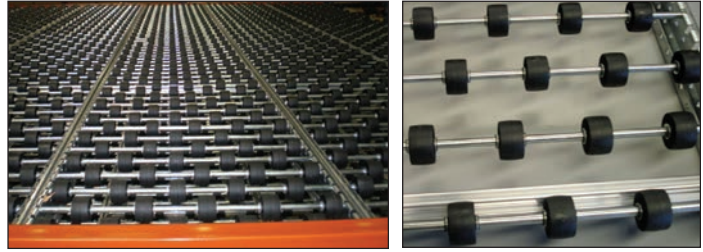

Please contact Crown Lift Trucks for a Carton Flow System quote today. Our experienced sales force will provide you with competitive pricing and assist with designing a rack layout that meets your requirements.

Capacities (Unsupported Span) lbs.

Span	DF-12	DF-16
48"	175	125
60"	108	82
72"	76	57
84"	56	41
96"	40	30
108"	28	21
120"	20	15

Cart-Trak

Carton Flow Conveyor with Steel Rollers

- Easy to handle drop-in sections of gravity flow rollers to convert static pallet rack into a carton flow system.
- Lane widths available to match carton widths.
- 3/4" diameter steel rollers available in 1", 2" and 3" centers.
- Attachment brackets for step-beam and structural mounting.

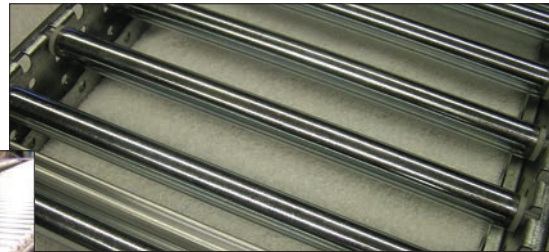
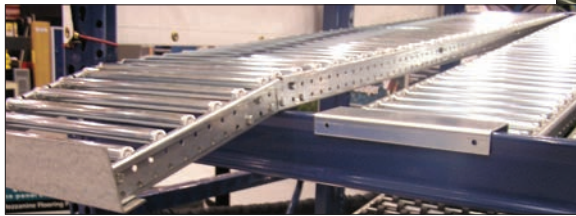

SHIPPING INFORMATION:
Call for Availability, F.O.B. Sterling, IL

Dyna Deck

Drop-In Carton Flow Shelf Repair System Drops Into ANY Carton Flow Shelf



Rails Don't Stay in Place?



Solid Bed of Wheels Solution

*Call Crown
to order a sample.*

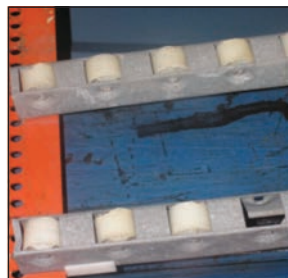

Dyna Deck Specifications:

- 1 1/2" top of roller
- 1 1/8" polypropylene wheels
- 5/16" diameter axles
- 12" and 16" widths
- 2" or 3" roller centers
- (6) 16" tracks will fill a 96" clear level
- Additional load capacity over carton flow rails, with beefed up wheels with larger diameter axles to allow improved product flow

Flow Rails

Skatewheel Rails

- 1.9" diameter, 100-lb. capacity steel skatewheels
- Mounted in 1" x 2 $\frac{5}{8}$ " x 1" 12-ga. galvanized steel channels

CAT. NO.	WHEEL CENTERS	WHEEL PATTERN	LENGTH
RF125-328-2-060	2"	In-line	5'
RF125-328-2-120	2"	In-line	10'
RF125-328S-1.5-060	1.5"	Staggered	5'
RF125-328S-1.5-120	1.5"	Staggered	10'

Optional: CRAS-02 Bolted End Stop

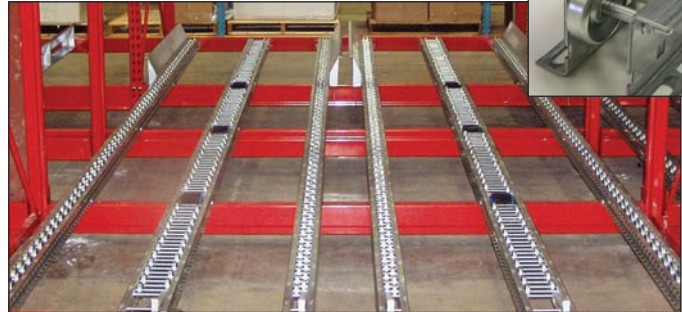

Magnum Wheeled Rails

- 2.9" diameter, 330-lb. capacity engineered resin wheels
- Mounted in 1" x 2 $\frac{5}{8}$ " x 1" 12-ga. galvanized steel channels

CAT. NO.	WHEEL CENTERS	WHEEL PATTERN	LENGTH
RF125-330-3-060	3"	In-line	5'
RF125-330-3-120	3"	In-line	10'
RF125-330S-2-060	2"	Staggered	5'
RF125-330S-2-120	2"	Staggered	10'

Optional: CRAS-03 Bolted End Stop



SHIPPING INFORMATION:
Call for Availability, F.O.B. Sterling, IL

Case Pick Pallet Separator for Pallet Flow

This simple to use device is designed to hold rear pallets back several inches from the front pallet to allow it to be free of dangerous back pressures. Rear pallets advance with a convenient foot release. Faster, safer, more efficient case picking is just a click or call away.



SHIPPING INFORMATION:
6-8 Weeks, F.O.B. Sterling, IL



**worldwide
materialhandling**

WorldDeck™ Wire Mesh Decking

Size (D x W)	Part #	Weight (lbs.)	Capacity*	Channels
Step Channel				
36" x 46"	ND3646S3C254046S00P	14.4	2500	3
42" x 46"	ND4246S3C254046A00P	16.1	2000	3
42" x 46"	ND4246S3SA254046S00P	17.9	2500	3
42" x 52"	ND4252S3SA254046S00P	19.1	2500	3
44" x 46"	ND4446S3SA254046S00P	18.9	2500	3
48" x 46"	ND4846S3SA254046S00P	20.6	2500	3
48" x 52"	ND4852S3SA254046S00P	21.9	3000	3
Flared Channel				
36" x 46"	ND3646F3FA254046S00P	15.7	2500	3
42" x 46"	ND4246F3FA254046S00P	18.0	2500	3
42" x 52"	ND4252F3FA254046S00P	19.4	2500	3
48" x 46"	ND4846F3FA254046S00P	20.6	2500	3

* Capacities (lbs.) based on UDL (uniform distributed load)
Additional sizes available; custom sizes available upon request



Step

- Most popular design
- Fits a 1-5/8" step beam

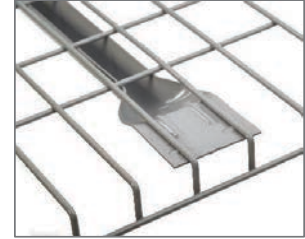

Flared

- Exclusive ribbed design
- Flared end welded to wire
- Fits on most pallet rack beams

WorldXBar™ Pallet Support Crossbars

Size	Part #	Weight (lbs.)	Capacity*	Width	Style	GA
36"	NDCBF362140H	3.8	1450	2"	Double Flanged	16
42"	NDCBF422140H	4.5	1450	2"	Double Flanged	16
42"	NDCBH422140H	3.9	1250	2"	Hat Style	16
44"	NDCBF442140H	4.7	1350	2"	Double Flanged	16
48"	NDCBF482140H	5.0	1250	2"	Double Flanged	16

* Capacities (lbs.) based on UDL (uniform distributed load)
Custom sizes and designs available

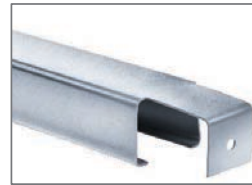

Double Flanged

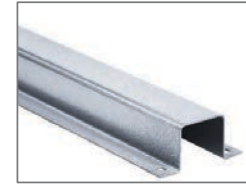

Hat Style

WorldStop™ Pallet Safety Stop

Size	Part #	Weight (lbs.)
Single Stop	NDWSS00033050050000P	3.1
12" Double Stop	NDWSD12063050156200P	4.6
18" Double Stop	NDWSD18063050156200P	6.2
24" Double Stop	NDWSD24063050156200P	7.8

Custom sizes and designs available



WorldStop Double



WorldStop Single

WorldTainer™ Wire Mesh Containers

Model	Part #	Size (D x W x H)	Weight (lbs.)	Mesh	Cap.**
Junior	NDWJ20322230SS000P	20" x 32" x 22"	52.9	1/2" x 1/2"	1,500
Medium	NDW532403460SS000P	32" x 40" x 34"	116.7	2" x 2"	4,000
Senior	NDW540483660SS000P	40" x 48" x 36"	152.6	2" x 2"	4,000
Extra Large	NDW540484260SS000P	40" x 48" x 42"	167.0	2" x 2"	4,000

* Capacities (lbs.) based on UDL (uniform distributed load)
Custom sizes and styles available
Wire baskets accessories and caster kit are only available from Chicago, IL or Los Angeles, CA.



RACK & SHELVING

SHIPPING INFORMATION: 2 Days, F.O.B.

Chicago, IL; Savannah, GA; Dallas, TX; Los Angeles, CA;
Tracy, CA; Seattle, WA; Allentown, PA

Rack Deck

- Installed on step ledges of pallet rack beams
- Cut to fit in any rack manufacturer's beams (including shelving)
- Top of deck is flush with top of beam
- Smooth top surface protects products
- Products slide easily on and off
- Available in 16, 18, 20, 22 and 24GA steel
- Widths from 6" to 36" at 6" increments
- Finishes available are painted or galvanized
- Also available perforated or vented
- Typical applications:
 - boxes (record centers/archive industry)
 - carpet and fabric
 - heavy duty die storage
 - lumber (cantilever rack)
 - palletized loads
 - fire baffles



Rain Deck

- Open area, corrugated rack deck
- Punched / perforated for sprinkler drainage
- Installed on step ledges of pallet rack beams
- Cut to fit in any rack manufacturer's step beams
- Top of deck is flush with top of beam
- Smooth top surface protects products
- Products slide easily on and off
- Available in 20, 22 and 24GA steel
- Widths from 12" to 36" at 6" increments
- Finishes available are painted or galvanized
- Typical applications:
 - boxes (record centers/archive industry)
 - carpet and fabric
 - cantilever rack
 - palletized loads

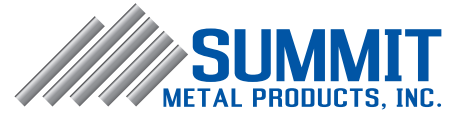

Cover Plates

- Smooth top surface protects products
- Fits over rain deck, rack deck, crossbar supports, wire deck
- Waterfall flanges formed to fit inside or outside of beams
- 10-22GA galvanized steel
- Available solid or perforated
- Typical applications:
 - furniture storage
 - retail storage
 - delicate items (fabric, carpet...)
 - goods with legs or casters

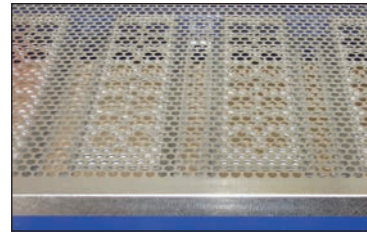

SHIPPING INFORMATION: 3-5 Weeks, F.O.B. Batavia, IL

PUNCH DECK® Corrugated Rack Deck

- Fire Protection: Designed for current fire codes
- Product Friendly: Smooth surface prevents product damage
- Uniform Strength: High capacity with low deflection
- No Waterfall Edge: Flush design for easy labeling on beam face
- Hi-Tech Look: Bright, galvanized finish or can be powder coated
- Ergonomically Designed: No product hang-ups that can cause injury

A. Punch Deck® Open Area Corrugated Rack Deck

Can be used in a variety of material handling applications, including:

- Records/archive storage — over 150,000,000 boxes now stored; used by industry leaders worldwide; available in custom sizes and capacities
- Carpet Storage — standard solid or with open area deck; lowered interior beams offer deck support; allows deep span decking for continuous deck surface
- Furniture storage — Punch Deck® Plus is Punch Deck® with perforated flat cap; provides flat surface with drainage; flat surface allows odd sizes to sit securely

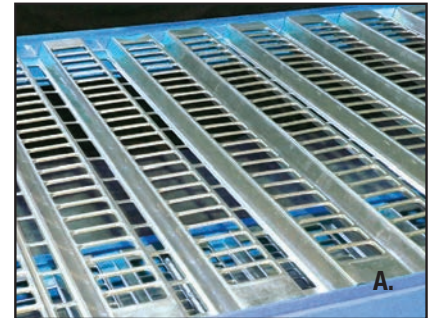

Open Area, Water Drainage Decking

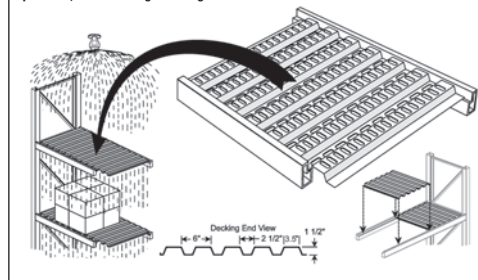

Open Area Accessory, Perforated Flat-Cap

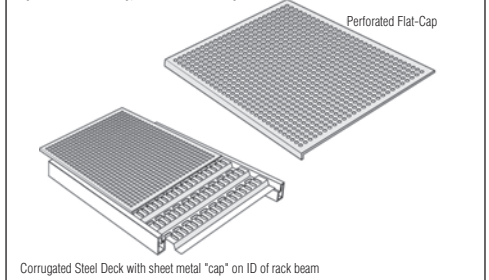

Call your Crown representative for pricing.



NASHVILLE WIRE PRODUCTS

Wire Rack Decking

Inventory is easier to see with sturdy wire decking. Reduces fire hazards and dirt and dust build-up. Keeps merchandise cleaner and safer. 1½" waterfall front and back. Decks accommodate 1½" or 1⅝" step beams. All Nashville Wire decks meet or exceed ANSI standards and are R-Marked.

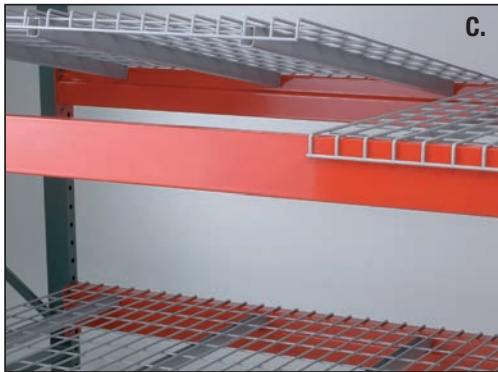

Capacities are based on an evenly distributed load. Other sizes and capacities available. Call for details.

C. Wire Rack Decking (2.5" x 4" Mesh Pattern)

CAT. NO.	CAPACITY (LBS.)	D X W	LBS.
D2446-AA-3B1	3500	24" x 46"	11
D3646-AA-3B1	2700	36" x 46"	16
D3652-AA-3B1	2700	36" x 52"	18
D3658-AA-3B1	2700	36" x 58"	19
D4246-AA-3A1	2700	42" x 46"	20
D4246-CA-3B1	2200	42" x 46"	18
D4246-EA-3A2*	2500	42" x 46"	28
D4252-AA-3A1	2700	42" x 52"	22
D4258-AA-3A1	2750	42" x 58"	23
D4846-AA-3C1	2500	48" x 46"	24
D4852-BA-3A1	2500	48" x 52"	27
D4858-BA-3A1	2500	48" x 58"	29

*Flared for box or structural beams. **Most popular sizes in bold.**

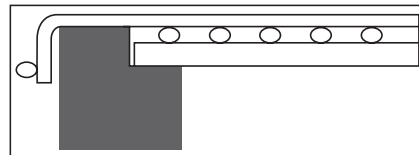

Fits standard 1⅝" and 1½" step down beams.

Quantity discounts available. Call for pricing.

SHIPPING INFORMATION: 1-2 Weeks
F.O.B. Nashville, TN; Springfield, TN; Frankfort, KY; El Paso, TX



RACK & SHELVING

Wire Mesh Containers

All Econotainers have convenient drop side gate design for easy access to products even when stacked at maximum safe heights. Econotainers meet or exceed all ANSI safety standards. Produced in TQM environment. Safety rating plates on all containers.



Collapsible containers fold to a fraction of their size when not used or when shipped empty.



Wire Mesh Containers*

CAT. NO.	CAPACITY (LBS.)	OUTSIDE DIMENSIONS W X L X H	USABLE HEIGHT	LBS.
JR1 (1 x 1 mesh)	1000	20" x 32" x 16"	16"	43
JR5 (½ x ½ mesh)	1000	20" x 32" x 16"	16"	55
C324028S4	4000	32" x 40" x 28"	28"	122
C404824S4	4000	40" x 48" x 24"	24"	150
C404830S4	4000	40" x 48" x 30"	30"	163
C404836S4	4000	40" x 48" x 36"	36"	176

*Zinc coated

SHIPPING INFORMATION: 1-2 Weeks
F.O.B. Frankfort, KY



Portable Stacking Racks

For storing or transport, these long-weathering racks save space and time.

Utilize vertical storage space by safely stacking these racks up to 5 high. Portable for easy handling of loads up to 4000 lbs. Rugged design stands up to heavy industrial requirements and prevents product damage. Save time by moving more material with fewer moves. Side and end frames are available to prevent load shifting. **Prices listed are for base frame style 4, with open deck.** For other base frame or deck styles, call for pricing.

2000 LB. CAPACITY: (S)
 Corner posts - 1 1/2" square tubing. Pockets: 1 1/2" square tubing.
4000 LB. CAPACITY: (H)
 Corner posts - 2.170" square tubing. Pockets: 2 1/2" square tubing.

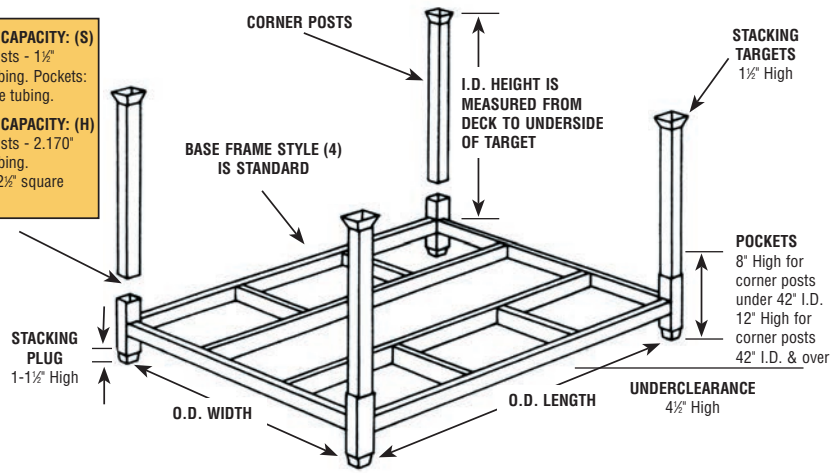

BASE FRAME

SIZE W X L (O.D.)	2000 LB. CAPACITY		4000 LB. CAPACITY	
	CAT. NO.	LBS.	CAT.	NO. LBS.
36" x 60"	S3660C2*	53	H3660D4*	75
42" x 48"	S4248C2*	49	—	—
42" x 60"	S4260C2*	55	—	—
48" x 48"	S4848C2*	52	H4848D4*	74
48" x 54"	—	—	H4854D4*	78
60" x 48"	—	—	H6048D4*	81
60" x 60"***	S6060C2*	68	H6060D4*	90

* Stock size. NOTE: All stock sizes have 12" pockets. Standard Color: Blue
 ** Style 5 base.

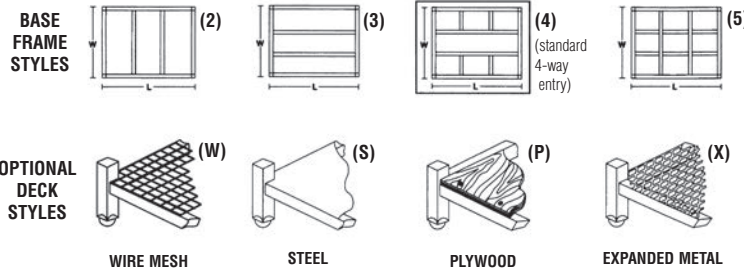

RACK & SHELVING

ADDITIONAL SIZES AVAILABLE

Let us design a storage system to fit your requirements. Specifications needed: weight of load, no. of units required, size of base, height of posts above deck, contents, stacked how high, base frame style and deck style.

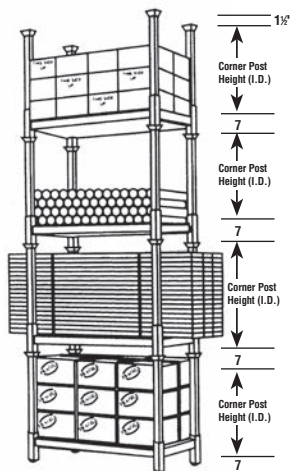

CORNER POSTS - SET OF 4

HT. ABOVE DECK (I.D.)	2000 LB. CAPACITY		4000 LB. CAPACITY	
	CAT. NO.	LBS.	CAT. NO.	LBS.
24"	P24C2	18	P24D4	26
30"	P30C2	22	P30D4	31
36"	P36C2	25	P36D4	36
48"	P48C2	31	P48D4	45
60"	P60C2	52	P60D4	70

SHIPPING INFORMATION: 1-2 Weeks, F.O.B. Mississippi

NOTE: With any changes to the above items or any other sizes, lead time varies (FOB: MS or NC).



Label Holders

Open-Edge label holders are a top-loading clear PVC label holder with an adhesive backing.

Slip-Strip label holder is a unique bottom-loading clear PVC plastic label holder with a white backing, complete with self adhesive tape for easy application to most surfaces.

Magnetic label holders are the choice for those who want a flexible option to identification.

Rack Load Signs

Rack load signs are laser printed on polyester paper stock with a permanent pressure-sensitive adhesive and applied to a 1/16" styrene backer board. Project Coordinators will need your load limit data, color and layout requirements to finalize your order.

Hanging Signs

Hanging signs are manufactured from 1/8" PVC with long-life vinyl characters in a range of sizes, colors and configurations, as well as long-range reflective bar code labels to suit individual needs.

Rack Labels

Polyester Location Labels are produced to standard sizes or tailored to individual needs.

Magnetic Location Labels are produced from a unique magnetic material that is flexible yet tough, making them ideal for use in warehouses.

Plastic Labels are a construction of four layers bonded under a heat process to create one extremely tough label.

Label Holders



A. Open-Edge

The 'U' profile design makes it one of the most popular and easy to use label holders available. Special order sizes are available.

Paper inserts are included. Sold in packages of 50.



B. Slip-Strip

A quick hold design most often used on shelving where quick changes are made and shelf faces are narrow.

Specify width and length to place an order.



C. Magnetic

Magnetic label holders allow the user to change the warehouse label and label holder as one unit or individually. Made from a unique magnetized rubber material. Paper inserts are provided. Specify width and length to place an order.



D. Floor Label Window

Easy to apply clear panel produced with chamfered edges, from the same material used to produce bullet proof glass on jet fighters. Adhesive strip backing.

One size, 10"x8", holds label/insert up to 6"x10". Sold in packs of 25.

SPECIFY SIZE	
	1" x 3"
	1/2" x 6"
	1" x 6"
	2" x 6"
	3" x 5"

HEIGHT	LENGTH
3/4"	36"
1"	48"
1 1/4"	
1 1/2"	
2"	
3"	

HEIGHT	LENGTH
1/2" x	2", 3", 4", 6", 8"
3/4" x	2", 3", 4", 6", 8", 12"
1" x	2", 3", 4", 6", 8", 12"
2" x	3", 4", 6", 8", 12"
3" x	4", 6", 8", 12"

Warehouse Signs

E. Rack Load Signs

Printed direct to board, these load signs present important information for storage structures and are approved by the Rack Manufacturers Institute (RMI).

Sold as singles and supplied with adhesive pads or screws. Request your preference.

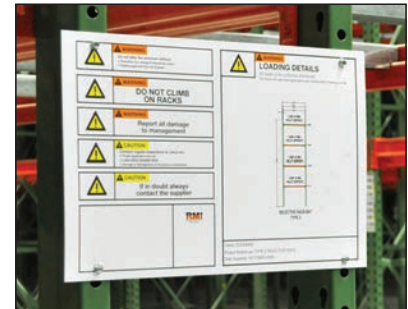

F. Hanging Signs



Installation Services Available.

Signs are supplied with a 3" return set to a 45° angle and complete with two holes so the sign can be attached to conduit or so wire can be threaded through. Specify size and quantity to order.

SPECIFY SIZE	
	9" x 12"
	9" x 16"
	9" x 24"
	13" x 16"

Pricing based on minimum order of standard sizes. If custom sizes are required, please contact your Crown representative for pricing.

SHIPPING INFORMATION:
1-2 Weeks, F.O.B. Buford, GA

Aisle Signs

Can be fitted with adhesive pads, magnetic strip or can be drilled by the user to be attached with screws. Aisle signs are manufactured from 1/2" PVC with content applied direct to board in black on white of full color configurations. Supplied as flat signs or with a 90° bend.



SINGLE-SIDED FLAT SIGNS

SIZE	INSTALLATION METHOD*
12" x 12"	*
12" x 16"	*
16" x 16"	*
12" x 24"	*
24" x 24"	*

Minimum of 5 must be ordered

DOUBLE-SIDED FOLDED SIGNS

SIZE	INSTALLATION METHOD*
12" x 10"	*
12" x 14"	*
16" x 14"	*

Minimum of 5 must be ordered

***Installation Method:** Specify adhesive, metal screws or none.

Color Configuration: Specify Black on White or Chosen Colors.

Rack Location Labels

Rack labels are designed to meet your customer needs. We list standard sizes here but can work on a custom level with full support, including installation services where needed. Produced with alpha, numeric, linear bar code and 2D codes. Full color designs available and recommended to help identify levels in areas. Various design options for placement and configuration needs.



G. Magnetic

Produced on magnetized rubber with printed polyester surface.

- Applied at almost any temperature.
- Removed without mess or scraping.
- Can be reapplied without peeling.
- Enables a dynamic numbering system.



I. Polyester Labels

The most popular rack label, polyester is an extremely strong and stable material retaining original profile, therefore print clarity and deflection is beyond almost any other.

- Hard-wearing scratch-resistant print.
- Tough base material.
- Permanent adhesive.
- Inverted characters and bar codes.



H. Reflective Labels

Specialized labels produced from reflective material with black print, to enable long range scanning, selected for high beam location labels and scanned from the ground.

- Scannable at long distance.
- Self-adhesive backing.
- Highest grade 3M material.



J. Multi Level Plastic

A thick and durable material which is ideal for rack frame uprights and beam labels. The same technology as used in durable floor labels, available with high strength adhesive.

- Vandal resistant.
- Self-adhesive backing.
- Can be reapplied without peeling.
- Ask about freezer adhesive.

STANDARD LABEL SIZES		
2" x 4"	3" x 4"	4" x 4"
2" x 5.5"	3" x 5.5"	4" x 5.5"
2" x 8"	3" x 8"	4" x 8"

PLASTIC LABEL SIZES
2 3/4" x 6" - 8"
2 3/4" x 9" - 11"
2 3/4" x 12" - 16"

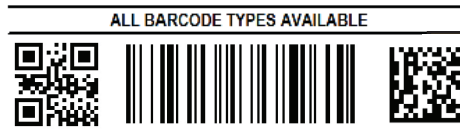

Pricing based on minimum order of standard sizes. If custom sizes are required, please contact your Crown representative for pricing.

Max Load Labels

Max load labels are designed to provide the safe load capacity limits of pallet racking and storage shelves. Choose from our standard designs and range of sizes or contact us for any customer specific requests.

SIZE	DESIGN
2" x 4"	T1, T2, T3, T4
2" x 6"	T1, T2, T3, T4
2" x 8"	T1, T2, T3, T4
2.5" x 4"	T1, T2, T3, T4
2.5" x 6"	T1, T2, T3, T4
2.5" x 8"	T1, T2, T3, T4
3" x 4"	T1, T2, T3, T4
3" x 6"	T1, T2, T3, T4
3" x 8"	T1, T2, T3, T4

All sold in packs of 25



T1: Load Limit Capacity Label



T2: Rack Capacity Label



T3: Shelf Load Capacity Label



T4: Beam Load Capacity Label

SHIPPING INFORMATION: 1-2 Weeks, F.O.B. Buford, GA

MACHINE GUARDING SOLUTIONS

We offer a flexible modular panel system, which together with our unique solutions for fixings and posts, fit our mesh, full steel, and polycarbonate panels. As many of our fixing systems use the same posts, all can be combined or interchanged with the machine guarding for the most optimal solution for your requirements.



Rapid Fix

Quick and easy access when you need it

Rapid Fix is a cleverly designed machine safety system that offers a quick and easy access to the hazard zone. The lower bracket has a slot that the panel hooks into and the upper bracket has an innovative locking mechanism that snaps the panel into its correct position.

Smart Fix

A strong and proven system

Smart Fix is our well-proven safeguard system with many unique properties. The fixings are tightened to the post and can easily be moved up and down to adjust for uneven floors and tunnels for conveyors.

Competition line, stainless

Competition-Line is a modular machine guarding system engineered for the food industry that satisfies the requirements for hygiene, ease of cleaning and safety. Competition-Line is a complete stainless steel system available in AISI 304, and acid-resistant AISI 316 upon request.

Easily adjusted on site

The system is easy to install and possible to adjust in both height and length on site. Based on welded mesh panels without frame it allows for any cut-outs you might need to make in your guarding. Such flexibility ensures that you always get the best possible individual solution for your machine protection and guarding.



Please contact your Crown representative for more information.



WIRE MESH PARTITIONS, CAGES & PALLET RACK BACKING

It is no coincidence that our systems can be adapted and constructed to suit your specific needs. Everything is well planned down to the smallest detail. Our systems can be combined with each other, something that is unique and creates a future-proof investment.

Partitioning with mesh walls

Our mesh panels or full steel panels are an excellent alternative to brick wall installations in cost terms and are an excellent complement to partitioning walls. You can build the wall right up to the existing ceiling or, alternatively, use our mesh ceiling, which provides an excellent overview, access for light and sprinkler systems and prevents unauthorized persons from gaining access.

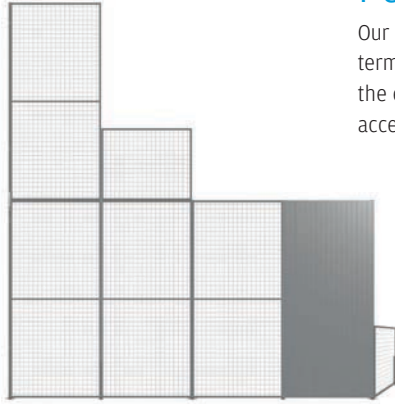

2"x 2"

50x50 mm mesh panels are an ideal solution for providing a safe working environment that allows natural light and ventilation.

Tube UR: 3/4" x 3/4" or UX: 1 1/4" x 3/4"
Wire UR: 10 guage or 8 guage.

Heights:
31 1/2" and 87"

Widths:
8", 12", 27 1/2", 31 1/2", 39 1/2", 47", 59"



Post

Our posts have a stable design and are the backbone of our systems.



Cylinder Lock

We offer a number of different Euro cylinders. Contact your seller for more information.



Padlocks

Where cylinder locked doors are not required, you can specify our doors as padlock type. Contact your seller for more information.



Panic bar

If you need emergency evacuation facilities, then choose our Panic Bar Door. The door is available as a hinged door with cylinder locking. Contact your seller for more information.

Musca Pallet Rack Backing

The Musca pallet Rack Backing system prevents any risk of spillage from pallets in warehouse storage. This is a system that has been created for safe handling and storage of products in a logistics environment.



Rack Backing

Fitting our Musca Pallet Rack Backing is easy using brackets that fit most pallet racking types. The screen prevents pallet spillage.



Musca Bracket



High Assembly



Musca Bracket

WireCrafters Pre-Engineered Enclosures

**With 4' Wide Sliding or
3' Wide Hinged Gates**

Choose the size and gate type that best fits your needs. Dimensions listed show the area to be enclosed; actual structure will be slightly larger (2" to 8"). Each item listed includes gate with cylinder lock, assembly hardware, floor anchors.

Universal construction, works for left or right hand, inside or outside mounting or swing.

Custom sizes available.

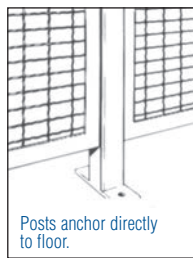

Posts anchor directly to floor.

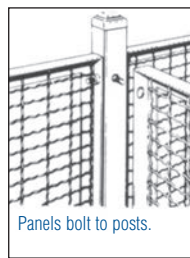

Panels bolt to posts.

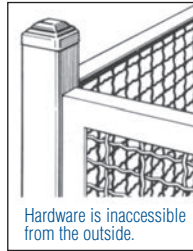

Hardware is inaccessible from the outside.

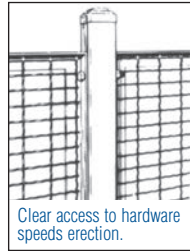

Clear access to hardware speeds erection.



L X W X H	Without Roof			With Roof		
	SLIDING GATE CAT. NO.	HINGED GATE CAT. NO.	LBS.	SLIDING GATE CAT. NO.	HINGED GATE CAT. NO.	LBS.
8' x 8' x 8'	66080	66086	319	66140	66146	445
12' x 8' x 8'	66081	66087	395	66141	66147	575
12' x 12' x 8'	66082	66088	439	66142	66148	749
16' x 8' x 8'	66083	66089	441	66143	66149	683
16' x 12' x 8'	66084	66090	485	66144	66150	864
16' x 16' x 8'	66085	66091	561	66145	66151	1017

L X W X H	Without Roof			With Roof		
	SLIDING GATE CAT. NO.	HINGED GATE CAT. NO.	LBS.	SLIDING GATE CAT. NO.	HINGED GATE CAT. NO.	LBS.
8' x 8' x 8'	66100	66106	446	66160	66166	581
12' x 8' x 8'	66101	66107	726	66161	66167	915
12' x 12' x 8'	66102	66108	642	66162	66168	961
16' x 8' x 8'	66103	66109	665	66163	66169	916
16' x 12' x 8'	66104	66110	688	66164	66170	1076
16' x 16' x 8'	66105	66111	810	66165	66171	1275

L X W X H	Without Roof			With Roof		
	SLIDING GATE CAT. NO.	HINGED GATE CAT. NO.	LBS.	SLIDING GATE CAT. NO.	HINGED GATE CAT. NO.	LBS.
8' x 8' x 8'	66120	66126	594	66180	66186	738
12' x 8' x 8'	66121	66127	726	66181	66187	924
12' x 12' x 8'	66122	66128	866	66182	66188	1194
16' x 8' x 8'	66123	66129	838	66183	66189	1098
16' x 12' x 8'	66124	66130	937	66184	66190	1343
16' x 16' x 8'	66125	66131	1080	66185	66191	1563

Options

A. Service Windows

Lockable slide-up window secures opening when unattended. **Window opening:** 24" w x 20½" h; **shelf size:** 24" w x 18" d x 10 gauge; **shelf height:** 42¼" off floor level; **panel size:** 4' w x 8' h; transoms extend height to 10' or 12'. Counter balanced, hinged, or mechanically operated windows in various sizes are available.

B. Vertical Rise Gates

Sized to match customer specifications. Gates slide on ball-type casters. Counter balanced, pneumatic, or electric operated gates available. Often used around vertical lifts where floor space is limited; can be integrated with automated storage systems.

C. Tunnel Doors

Designed for no overhead obstruction. Leading edge of door rolls on floor casters. Rear of door hangs from door track. All sizes made to order. Ideal for high traffic areas and overhead crane access.

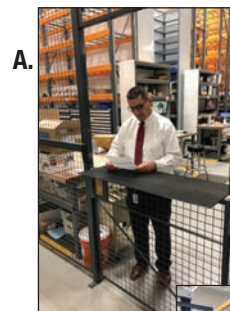

A.



B.



C.

Rack Guard

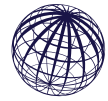

InCord[®]
Custom Safety Netting Solutions

InCord Rack Guard minimizes product loss and protects personnel. Safety netting systems are ideal for single and gravity-flow racks in warehouses, distribution centers, or manufacturing environments.

- Customized to your specifications
- Complete attachment systems

Key Applications:

- Front of rack
- Back of rack
- End of rack
- Horizontal
- Flue Spaces



RACK & SHELVING



A. PalletGard®

Constructed from 1 1/4" angle frame and 2" x 1" x 10 gauge rectangular mesh. Clips are sold separately. One package containing four clips is required per panel.

HT.	3'6" WIDE		8' WIDE		9' WIDE		10' WIDE	
	CAT. NO.	LBS.	CAT. NO.	LBS.	CAT. NO.	LBS.	CAT. NO.	LBS.
3'	390167	14	---	---	---	---	---	---
4'	390166	21	390121	55	390111	60	390101	65
5'	390165	26	390021	65	390011	70	390001	75

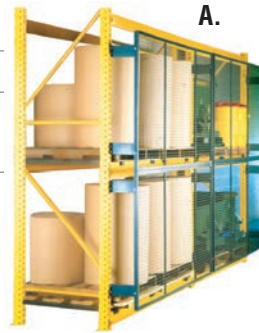

A.



PalletGard®

Keep objects from falling off loaded pallet racks by using PalletGard panels. Easy to install, just bolt clips to pallet rack upright and fasten to panel. The 3'6" wide panels are used to enclose ends of racks. Painted dark gray.

All units have a safety retaining chain and trip rope assembly.

B. Clips

Clips are designed to fit most standard, drilled pallet racks spaced 2" on center. Painted dark gray. Four clips in each package. Includes nuts and bolts.

CAT. NO.	LENGTH	LBS.
393200	1 1/4"	2
393210	4"	3
393220	6"	4
393230	8"	5



B.

SHIPPING INFORMATION:
1-3 Weeks, F.O.B. Litchfield, MI

NOTE: Wire mesh panels require a shipping crate

C. RapidWire™ RackBack® Safety Panels

Panels have mounting holes on six inch centers and are provided with flush mount or offset brackets to allow for pallets that overhang the beams.

CAT. NO.	BEAM W X H	LBS.
RB68	6' x 8'	301
RB88	8' x 8'	325
RB98	9' x 8'	335
RB810	8' x 10'	349
RB910	9' x 10'	353
RB1010	10' x 10'	363
RB812	8' x 12'	380
RB912	9' x 12'	395
RB1012	10' x 12'	410
RB814	8' x 14'	404
RB914	9' x 14'	413
RB1014	10' x 14'	428
RB816	8' x 16'	435
RB916	9' x 16'	455
RB1016	10' x 16'	475

All material painted gray and palletized for shipment.

SHIPPING INFORMATION: 1 Week, F.O.B. Louisville, KY



C.

WireCrafters

RapidWire™ RackBack® Safety Panels

Improve warehouse safety — contain falling items. Modular-sized panels mount directly to pallet rack system. Installs quickly and provides safety. System is made of 2" x 2" x 10 gauge steel-welded wire mesh, welded into a 1 1/4" x 1 1/4" x 13 gauge steel angle frame. Custom sizes available.

D. Distribution Lockers - 2' W x 8'5 1/4" Overall Height

Each locker contains four 2' W x 1'8" H tiers and sheet metal header panel above - wire mesh ceilings - no back panels - powder coat gray - padlock lugs only.

CAT. NO.	LOCKER QTY.	LBS.
DL1	1	714
DL2	2	1020
DL3	3	1326
DL4	4	1632
DL5	5	2087
DL6	6	2593
DL7	7	2899
DL8	8	3205
DL9	9	3659
DL10	10	3965



D.



SHIPPING INFORMATION: 4-5 Weeks, F.O.B. Louisville, KY



Open & Closed Clipper® Heavy Duty Shelving Units - 028 Gray

QuickShip

Use an **Open Clipper Basic Unit** to start a single unit or a row of shelving. Add additional Clipper Basic Units to add to a row. To end a row or single unit, finish the unit with an **Open End Kit**.

Use a **Closed Clipper Basic Unit** to start a single unit or a row of shelving. Add additional Clipper Basic Units to add to a row. To end a row or single unit, finish the unit with a **Closed End Kit**.

Open Clipper Basic Unit

- 1 Front Box Post - 14 Ga.,
- 2 Rear Offset Angle Posts - 14 Ga.,
- 1 Side & 1 Back Sway Brace, Heavy-Duty Hi-Performance® Shelves

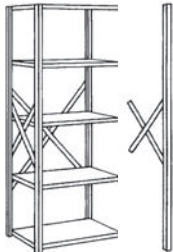

Open Clipper End Kit

Used to end single units or a row of Heavy Duty Open Clipper Units

- 1 Front Box Post - 14 Ga.,
- 1 pair of Side Sway Braces

(Order End Kits in the appropriate depth)

Color: 028 Gray

Closed Clipper Basic Unit

- 1 Front Box Post - 14 Ga.,
- 2 Rear Offset Angle Posts - 14 Ga.,
- 1 Side & 1 Back Panel, Heavy-Duty Hi-Performance® Shelves

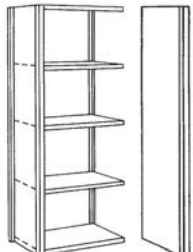

Closed Clipper End Kit

Used to end single units or a row of Heavy Duty Closed Clipper Units

- 1 Front Box Post - 14 Ga.,
- 1 Side Panel

(Order End Kits in the appropriate depth)

Color: 028 Gray

NOTE: Many additional size combinations are available outside the QuickShip program.

Open Clipper Basic Units – Heavy Duty Hi-Performance Shelves

5 SHELVES

	W X D X H	CAT. NO.	CAP./SHELF (LBS.)	LBS.
	36" x 12" x 87"	1H7015028	800	62.0
36" x 18" x 87"	1H7025028	850	73.4	
36" x 24" x 87"	1H7035028	800	84.3	
48" x 12" x 87"	1H7075028	500	73.6	
48" x 18" x 87"	1H7085028	500	88.0	
48" x 24" x 87"	1H7095028	530	102.3	

6 SHELVES

	W X D X H	CAT. NO.	CAP./SHELF (LBS.)	LBS.
	36" x 12" x 87"	1H7016028	800	69.3
36" x 18" x 87"	1H7026028	850	82.9	
36" x 24" x 87"	1H7036028	800	95.9	
48" x 12" x 87"	1H7076028	500	82.6	
48" x 18" x 87"	1H7086028	500	99.8	
48" x 24" x 87"	1H7096028	530	116.9	

7 SHELVES

	W X D X H	CAT. NO.	CAP./SHELF (LBS.)	LBS.
	36" x 12" x 87"	1H7017028	800	76.6
36" x 18" x 87"	1H7027028	850	92.4	
36" x 24" x 87"	1H7037028	800	107.5	
48" x 12" x 87"	1H7077028	500	91.7	
48" x 18" x 87"	1H7087028	500	111.7	
48" x 24" x 87"	1H7097028	530	131.5	

8 SHELVES

	W X D X H	CAT. NO.	CAP./SHELF (LBS.)	LBS.
	36" x 12" x 87"	1H7018028	800	83.9
36" x 18" x 87"	1H7028028	850	101.9	
36" x 24" x 87"	1H7038028	800	119.1	
48" x 12" x 87"	1H7078028	500	107.7	
48" x 18" x 87"	1H7088028	500	123.5	
48" x 24" x 87"	1H7098028	530	143.2	

Open Clipper End Kits

To end row of open shelving. Consists of front box post and 1 pair of side sway braces.

	D X H	CAT. NO.	LBS.
	12" x 87"	101287028	10.1
18" x 87"	101887028	10.5	
24" x 87"	102487028	10.9	

Closed Clipper Basic Units – Heavy Duty Hi-Performance Shelves

5 SHELVES

	W X D X H	CAT. NO.	CAP./SHELF (LBS.)	LBS.
	36" x 12" x 87"	1H8015028	800	83.7
36" x 18" x 87"	1H8025028	850	98.1	
36" x 24" x 87"	1H8035028	800	112.1	
48" x 12" x 87"	1H8075028	500	103.4	
48" x 18" x 87"	1H8085028	500	120.8	
48" x 24" x 87"	1H8095028	530	138.2	

6 SHELVES

	W X D X H	CAT. NO.	CAP./SHELF (LBS.)	LBS.
	36" x 12" x 87"	1H8016028	800	91.0
36" x 18" x 87"	1H8026028	850	107.6	
36" x 24" x 87"	1H8036028	800	123.7	
48" x 12" x 87"	1H8076028	500	112.5	
48" x 18" x 87"	1H8086028	500	132.7	
48" x 24" x 87"	1H8096028	530	152.9	

7 SHELVES

	W X D X H	CAT. NO.	CAP./SHELF (LBS.)	LBS.
	36" x 12" x 87"	1H8017028	800	98.3
36" x 18" x 87"	1H8027028	850	117.1	
36" x 24" x 87"	1H8037028	800	135.3	
48" x 12" x 87"	1H8077028	500	121.6	
48" x 18" x 87"	1H8087028	500	144.5	
48" x 24" x 87"	1H8097028	530	167.5	

8 SHELVES

	W X D X H	CAT. NO.	CAP./SHELF (LBS.)	LBS.
	36" x 12" x 87"	1H8018028	800	105.6
36" x 18" x 87"	1H8028028	850	126.6	
36" x 24" x 87"	1H8038028	800	146.9	
48" x 12" x 87"	1H8078028	500	130.6	
48" x 18" x 87"	1H8088028	500	156.4	
48" x 24" x 87"	1H8098028	530	182.1	

Closed Clipper End Kits

To end row of closed shelving. Consists of front box post and side panel.

	D X H	CAT. NO.	LBS.
	12" x 87"	1C1287028	14.1
18" x 87"	1C1887028	17.5	
24" x 87"	1C2487028	21.0	

Front bases must be ordered separately.

All shelving parts are painted 028 Gray with powder-coat enamel.

SHIPPING INFORMATION: 1 Week, F.O.B. Bensalem, PA

RACK & SHELVING

Long Span - Riv II

W X D X H	PER SHELF CAP. (LBS.)	Starter - 4 Shelves - With Decking		Adder - 4 Shelves - With Decking	
		CAT. NO.	LBS.	CAT. NO.	LBS.
48" x 18" x 7'	1000	07UL4818-4W*	75.6	07UL4818-4AW*	59.2
48" x 24" x 7'	1000	07UL4824-4W*	60.7	07UL4824-4AW*	56.0
48" x 30" x 7'	1200	07UL4830-4W*	83.6	07UL4830-4AW*	67.2
48" x 36" x 7'	1200	07UL4836-4W*	68.0	07UL4836-4AW*	71.2
48" x 48" x 7'	1400	07UL4848-4W*	94.8	07UL4848-4AW*	78.4
60" x 18" x 7'	800	07UL6018-4W*	83.6	07UL6018-4AW*	67.2
60" x 18" x 7'	1200	07UL6018-4HW**	90.0	07UL6018-4AHW**	73.6
60" x 24" x 7'	800	07UL6024-4W*	87.6	07UL6024-4AW*	71.2
60" x 24" x 7'	1200	07UL6024-4HW**	96.0	07UL6024-4AHW**	79.6
60" x 30" x 7'	800	07UL6030-4W*	91.6	07UL6030-4AW*	75.2
60" x 30" x 7'	1200	07UL6030-4HW**	102.0	07UL6030-4AHW**	85.6
60" x 36" x 7'	900	07UL6036-4W*	85.6	07UL6036-4AW*	79.2
60" x 36" x 7'	1300	07UL6036-4HW**	107.6	07UL6036-4AHW**	91.2
60" x 48" x 7'	900	07UL6048-4W*	102.8	07UL6048-4AW*	86.4
60" x 48" x 7'	1300	07UL6048-4HW**	118.8	07UL6048-4AHW**	102.4
72" x 18" x 7'	600	07UL7218-4W*	91.6	07UL7218-4AW*	75.2
72" x 18" x 7'	1000	07UL7218-4HW**	77.6	07UL7218-4AHW**	81.6
72" x 18" x 7'	1400	07UL7218-4HCW***	88.0	07UL7218-4AHCW***	83.4
72" x 24" x 7'	600	07UL7224-4W*	95.6	07UL7224-4AW*	79.2
72" x 24" x 7'	1000	07UL7224-4HW**	104.0	07UL7224-4AHW**	87.6
72" x 24" x 7'	1400	07UL7224-4HCW***	93.6	07UL7224-4AHCW***	89.0
72" x 30" x 7'	600	07UL7230-4W*	99.6	07UL7230-4AW*	83.2
72" x 30" x 7'	1000	07UL7230-4HW**	110.0	07UL7230-4AHW**	93.6
72" x 30" x 7'	1400	07UL7230-4HCW***	98.8	07UL7230-4AHCW***	94.2
72" x 36" x 7'	600	07UL7236-4W*	94.3	07UL7236-4AW*	87.2
72" x 36" x 7'	1000	07UL7236-4HW**	103.6	07UL7236-4AHW**	99.2
72" x 36" x 7'	1400	07UL7236-4HCW***	104.4	07UL7236-4AHCW***	99.8
72" x 48" x 7'	700	07UL7248-4W*	110.8	07UL7248-4AW*	94.4
72" x 48" x 7'	1000	07UL7248-4HW**	126.8	07UL7248-4AHW**	110.4
72" x 48" x 7'	1500	07UL7248-4HCW***	133.4	07UL7248-4AHCW***	110.6
96" x 18" x 7'	500	07UL9618-4W*	98.8	07UL9618-4AW*	94.2
96" x 18" x 7'	1000	07UL9618-4HCW***	112.6	07UL9618-4AHCW***	108.0
96" x 24" x 7'	500	07UL9624-4W*	106.0	07UL9624-4AW*	101.4
96" x 24" x 7'	1000	07UL9624-4HCW***	119.8	07UL9624-4AHCW***	115.2
96" x 30" x 7'	500	07UL9630-4W*	113.2	07UL9630-4AW*	108.6
96" x 30" x 7'	1000	07UL9630-4HCW***	127.0	07UL9630-4AHCW***	122.4
96" x 36" x 7'	500	07UL9636-4W*	120.4	07UL9636-4AW*	115.8
96" x 36" x 7'	1000	07UL9636-4HCW***	134.2	07UL9636-4AHCW***	129.6
96" x 48" x 7'	500	07UL9648-4W*	134.8	07UL9648-4AW*	130.2
96" x 48" x 7'	1000	07UL9648-4HCW***	148.6	07UL9648-4AHCW***	143.4

*Includes SS only; **H models include 14 ga. SS in conjunction with one STS; ***HC models include 14 ga. Channel SSC in conjunction with one or two STS depending on width of unit and use SS beams for bottom shelf level

Long Span - Riv II - Extra Shelf With Decking

W X D	PER SHELF CAP. (LBS.)	CAT. NO.	LBS.	W X D	PER SHELF CAP. (LBS.)	CAT. NO.	LBS.
48" x 24"	1000	UL4824W	11.8	72" x 30"	600	UL7230W	16.8
48" x 30"	1200	UL4830W	12.8	72" x 30"	1000	UL7230HW	19.4
48" x 36"	1200	UL4836W	13.8	72" x 30"	1400	UL7230HCW	23.0
48" x 48"	1400	UL4848W	15.6	72" x 36"	600	UL7236W	17.8
60" x 18"	800	UL6018W	12.8	72" x 36"	1000	UL7236HW	20.9
60" x 18"	1200	UL6018HW	14.4	72" x 36"	1400	UL7236HCW	24.4
60" x 24"	800	UL6024W	13.8	72" x 48"	700	UL7248W	19.6
60" x 24"	1200	UL6024HW	15.9	72" x 48"	1000	UL7248HW	23.6
60" x 30"	800	UL6030W	14.8	72" x 48"	1500	UL7248HCW	27.2
60" x 30"	1200	UL6030HW	17.4	96" x 18"	500	UL9618HW	20.4
60" x 36"	900	UL6036W	15.8	96" x 18"	1000	UL9618HCW	25.0
60" x 36"	1300	UL6036HW	18.8	96" x 24"	500	UL9624HW	21.4
60" x 48"	900	UL6048W	17.6	96" x 24"	1000	UL9624HCW	26.0
60" x 48"	1300	UL6048HW	21.6	96" x 30"	500	UL9630HW	24.0
72" x 18"	600	UL7218W	14.8	96" x 30"	1000	UL9630HCW	38.6
72" x 18"	1000	UL7218HW	16.4	96" x 36"	500	UL9636HW	25.8
72" x 18"	1400	UL7218HCW	20.0	96" x 36"	1000	UL9636HCW	30.4
72" x 24"	600	UL7224W	15.8	96" x 48"	500	UL9648HW	29.4
72" x 24"	1000	UL7224HW	17.9	96" x 48"	1000	UL9648HCW	34.0

Low Profile - Riv II

W X D	PER SHELF CAP. (LBS.)	Starter - 5 Shelves - With Decking		Adder - 5 Shelves - With Decking		Extra Shelf - With Decking	
		CAT. NO.	LBS.	CAT. NO.	LBS.	CAT. NO.	LBS.
36" x 12"	350	07U3612-5W	38.1	07U3612-5AW	31.6	U3612W	2.9
36" x 18"	350	07U3618-5W	39.9	07U3618-5AW	32.5	U3618W	2.9
36" x 24"	350	07U3624-5W	41.7	07U3624-5AW	33.4	U3624W	2.9
48" x 12"	250	07U4812-5W	43.9	07U4812-5AW	37.4	U4812W	3.9
48" x 18"	250	07U4818-5W	45.7	07U4818-5AW	38.3	U4818W	3.9
48" x 24"	250	07U4824-5W	47.5	07U4824-5AW	39.2	U4824W	3.9



The original boltless shelving!

RiveTier® Boltless Shelving assembles quickly and easily using only a rubber mallet. No Cross Braces means you have double-sided access to your materials for efficient loading and unloading. In minutes, your RiveTier storage system is ready to work!

- 40% less expensive than metal shelving
- 30% less expensive to assemble than metal shelving
- Heavy-duty bulk or low profile applications
- Typically utilizes particle board decking – wire or steel shelves available



SHIPPING INFORMATION: 7-10 Days, F.O.B. Paris, KY; Plano, TX; San Dimas, CA



Heavy-Duty Welded Steel Shelving

Reinforced 12-gauge steel shelves with 2000 lb. capacity per shelf. 2" x 2" x 3/16" corner angles have footpads with anchor. 72" overall height with 3 1/2" bottom shelf underclearance. Ships set up and ready for immediate use.

4 Shelf, 20 3/4" Shelf Clearance

D X W	CAT. NO.	LBS.
18" x 32"	4SH-1832-72	156
24" x 36"	4SH-2436-72	195
24" x 48"	4SH-2448-72	253
24" x 60"	4SH-2460-72	298
30" x 48"	4SH-3048-72	291
30" x 60"	4SH-3060-72	344

5 Shelf, 15" Shelf Clearance

D X W	CAT. NO.	LBS.
18" x 32"	5SH-1832-72	179
24" x 36"	5SH-2436-72	227
24" x 48"	5SH-2448-72	299
24" x 60"	5SH-2460-72	356
30" x 48"	5SH-3048-72	247
30" x 60"	5SH-3060-72	414



SHIPPING INFORMATION:
2 Weeks, F.O.B. FOB University Park, IL



EZ-GLIDE Specialty Racks

High density storage, EZ-GLIDE's 100% shelf extension allows quick, efficient loading and unloading of bulky items.

Easy to install, the EZ-GLIDE has welded and bolted construction with a solid steel top deck for extra rigidity (top deck does not roll out). Top deck may be used as the pick up point to conveniently relocate empty racks and for use as additional storage.

All standard EZ-GLIDE units have available add-on units that share a common upright. The add-on is for wall-to-wall racking of shelves ... or any length in between. The add-on connects to existing shelves creating a continuous assembly of any number. Units should be anchored to the floor (anchors not included).

EZ-GLIDE Specialty Racks

- 2,000 lb. load capacity per shelf
- Full 100% extension of every shelf
- Individual shelf height adjustable, based on 2-inch centers
- Modular construction allows bolt-together expansion of multiple units
- Horizontal access by forklift truck, cart, hand truck or any method with a height adjusting bed
- Vertical access via crane, manipulator or monorail system
- Welded and bolted steel construction
- Nine starter & add-on models available
- Shipped knocked down

STARTER UNITS

CAT. NO.	W X D X H	SHELVES	LBS.
EZ363662	36 x 36 x 62 1/2	3	911
EZ483662	48 x 36 x 62 1/2	3	1053
EZ484862	48 x 48 x 62 1/2	3	1260
EZ363672	36 x 36 x 72 1/2	3	932
EZ483672	48 x 36 x 72 1/2	3	1074
EZ484872	48 x 48 x 72 1/2	3	1281
EZ483684	48 x 36 x 84 1/2	4	1348
EZ484884	48 x 48 x 84 1/2	4	1510

ADD-ON UNITS

CAT. NO.	W X D X H	SHELVES	LBS.
EZ363662A	36 x 36 x 62 1/2	3	831
EZ483662A	48 x 36 x 62 1/2	3	973
EZ484862A	48 x 48 x 62 1/2	3	1174
EZ363672A	36 x 36 x 72 1/2	3	842
EZ483672A	48 x 36 x 72 1/2	3	984
EZ484872A	48 x 48 x 72 1/2	3	1185
EZ483684A	48 x 36 x 84 1/2	4	1245
EZ484884A	48 x 48 x 84 1/2	4	1407

ADDITIONAL SHELVES

CAT. NO.	SHELF SIZE	LBS.
EZSH3636	36 x 36	210
EZSH4836	48 x 36	248
EZSH4848	48 x 48	303



RACK & SHELVING

SHIPPING INFORMATION:
10 Days, F.O.B. Freeport, IL

Q-Line Industrial Shelving

- All units are 87" high with 5 steel shelves.
- Choose from widths of 36" and 48" and depths of 12", 18" and 24".
- Both open and closed units are available.
- Choose units with 22-gauge or 20-gauge steel shelves.
- Shelves are supported with compression clips; adjustable up and down in 1" increments.
- Add-on units are used with a starter unit to create a row of shelving.
- Accessories available to customize the units to meet your needs.
- Shelf load capacities are based on evenly distributed loads.
- Shipped unassembled.
- Medium gray powder coat finish.



Open Starter



Open Add-On



Closed Starter

Q-Line Industrial Steel Shelving — 87" High With (5) 22-Gauge Steel Shelves

Open Starters			Open Add-Ons			Closed Starters			Closed Add-Ons		
W X D	CAT. NO.	LBS.	CAT. NO.	LBS.	CAT. NO.	LBS.	CAT. NO.	LBS.	CAT. NO.	LBS.	
36" x 12"	QO5-3612S	62	QO5-3612AB	56	QC5-3612S	89	QC5-3612AB	78			
36" x 18"	QO5-3618S	73	QO5-3618AB	66	QC5-3618S	107	QC5-3618AB	93			
36" x 24"	QO5-3624S	83	QO5-3624AB	77	QC5-3624S	125	QC5-3624AB	107			
48" x 12"	QO5-4812S	73	QO5-4812AB	66	QC5-4812S	108	QC5-4812AB	97			
48" x 18"	QO5-4818S	86	QO5-4818AB	80	QC5-4818S	129	QC5-4818AB	115			
48" x 24"	QO5-4824S	100	QO5-4824AB	93	QC5-4824S	150	QC5-4824AB	132			

Q-Line Industrial Steel Shelving — 87" High With (5) 20-Gauge Steel Shelves

Open Starters			Open Add-Ons			Closed Starters			Closed Add-Ons		
DEPTH	CAT. NO.	LBS.	CAT. NO.	LBS.	CAT. NO.	LBS.	CAT. NO.	LBS.	CAT. NO.	LBS.	
36" x 12"	QOH5-3612S	69	QOH5-3612AB	62	QCH5-3612S	95	QCH5-3612AB	85			
36" x 18"	QOH5-3618S	81	QOH5-3618AB	75	QCH5-3618S	116	QCH5-3618AB	101			
36" x 24"	QOH5-3624S	94	QOH5-3624AB	87	QCH5-3624S	135	QCH5-3624AB	117			
48" x 12"	QOH5-4812S	81	QOH5-4812AB	75	QCH5-4812S	116	QCH5-4812AB	106			
48" x 18"	QOH5-4818S	97	QOH5-4818AB	91	QCH5-4818S	140	QCH5-4818AB	126			
48" x 24"	QOH5-4824S	113	QOH5-4824AB	107	QCH5-4824S	163	QCH5-4824AB	145			

Extra Shelves for 36" & 48" Wide Shelving

DEPTH	36" W - 22 Gauge			48" W - 22 Gauge			36" W - 20 Gauge			48" W - 20 Gauge		
	CAT. NO.	LBS.	CAT. NO.	LBS.	CAT. NO.	LBS.	CAT. NO.	LBS.	CAT. NO.	LBS.		
12"	Q2-3612	7	Q2-4812	9	Q-3612	8	Q-4812	10				
18"	Q2-3618	9	Q2-4818	11	Q-3618	11	Q-4818	14				
24"	Q2-3624	11	Q2-4824	14	Q-3624	13	Q-4824	17				

SHIPPING INFORMATION:
1-2 Weeks,
F.O.B. Dickson, TN

Sliding Shelf Dividers

CAT. NO.	D X H	LBS.
SD-1260	12" x 6"	1
SD-1860	18" x 6"	2
SD-2460	24" x 6"	2

Shelf Box Dividers

Galvanized			
CAT. NO.	W X H	LBS.	
BXD-5	5.25" x 4.5"	0.2	
BXD-8	8" x 4.25"	0.3	

Shelf Boxes

Standard with one divider			
CAT. NO.	W X D X H	LBS.	
BX-512	5.5" x 11" x 4.5"	3	
BX-518	5.5" x 17" x 4.5"	3	
BX-812	8.25" x 11" x 4.5"	4	
BX-818	8.25" x 17" x 4.5"	3	

Front Base Strip

CAT. NO.	W X H	LBS.
FBS-362	36" x 2"	1
FBS-482	48" x 2"	2

Shelf Box Guides

Order 1 pair per shelf; use with shelf boxes

CAT. NO.	DESCRIPTION	LBS.
BXG-12	Pair-12"	1
BXG-18	Pair-18"	1

Shelf Load Capacities (per shelf)

SIZE	22-GAUGE (LBS.)	20-GAUGE (LBS.)
36" x 12"	750	1000
36" x 18"	750	850
36" x 24"	700	800
48" x 12"	500	650
48" x 18"	500	550
48" x 24"	450	550

Additional Accessories

CAT. NO.	DESCRIPTION	LBS.
HD-3687RH	Hinged Doors/Frame	63
FP-1	Floor Anchor Bracket	—



A.



B.

A. Z-Line Rivet Shelving — 84" High With (5) 22-Gauge Steel Shelves

W X D	Starters			Add-Ons		Extra Shelves	
	CAT. NO.	LBS.	SHELF CAP. (LBS.)	CAT. NO.	LBS.	CAT. NO.	LBS.
36" x 12"	ZM7-3612S-5D	59	750	ZM7-3612A-5D	58	ZMS-3612	7
36" x 18"	ZM7-3618S-5D	71	750	ZM7-3618A-5D	69	ZMS-3618	9
36" x 24"	ZM7-3624S-5D	83	700	ZM7-3624A-5D	8	ZMS-3624	11
48" x 12"	ZM7-4812S-5D	72	500	ZM7-4812A-5D	71	ZMS-4812	9
48" x 18"	ZM7-4818S-5D	87	500	ZM7-4818A-5D	89	ZMS-4818	11
48" x 24"	ZM7-4824S-5D	102	450	ZM7-4824A-5D	99	ZMS-4824	14

B. Heavy-Duty Reinforced Shelving — With (5) 16-Gauge Steel Shelves

W X D	72" High			84" High		Extra Shelves	
	CAT. NO.	LBS.	SHELF CAP. (LBS.)	CAT. NO.	LBS.	CAT. NO.	LBS.
36" x 18"	RXHS-361872	147	4000	RXHS-361884	155	RXHS-3618	25
36" x 24"	RXHS-362472	202	4000	RXHS-362484	210	RXHS-3624	36
48" x 18"	RXHS-481872	181	4000	RXHS-481884	189	RXHS-4818	32
48" x 24"	RXHS-482472	214	4000	RXHS-482484	222	RXHS-4824	38
60" x 24"	RXHS-602472	255	3250	RXHS-602484	263	RXHS-6024	45
72" x 24"	RXHS-722472	305	2750	RXHS-722484	313	RXHS-7224	56
72" x 36"	RXHS-723672	414	2750	RXHS-723684	422	RXHS-7236	79
96" x 24"	RXHS-962472	413	2600	RXHS-962484	420	RXHS-9624	78
96" x 36"	RXHS-963672	561	2600	RXHS-963684	569	RXHS-9636	108

C. Sloping Shelf Units — 84" High With (5) 16-Gauge Steel Shelves

W X D	Starters			Add-Ons	
	CAT. NO.	LBS.	SHELF CAP. (LBS.)	CAT. NO.	LBS.
36" x 18"	ZT7-3618S-5	134	400	ZT7-3618A-5	134
36" x 24"	ZT7-3624S-5	158	400	ZT7-3624A-5	158
48" x 18"	ZT7-4818S-5	184	400	ZT7-4818A-5	184
48" x 24"	ZT7-4824S-5	214	400	ZT7-4824A-5	214

All shelving units ship unassembled.

SHIPPING INFORMATION:
5 Days, F.O.B. Dickson, TN

C.



Boltless Steel Shelving

Z-Line shelving is ideal for light to medium duty applications (shelf load capacities up to 750 lbs.). Posts are 84" high. Shelves are 22-gauge steel with boxed-formed front and rear flanges and fully lapped and welded corners. Top and bottom shelves are supported on four sides with 16-gauge supports. Intermediate shelves are supported with shelf clips. Each unit consists of five shelves. Medium gray or sand finish.

Heavy-Duty Reinforced Shelving

Each shelf will support up to 4000 lbs. evenly distributed. Maximum capacity per unit is 13,000 lbs. Each unit has (5) 16-gauge shelves that waterfall over the front and back shelf supports. Shelves are supported on all four sides with 14-gauge shelf supports with double rivets. 36", 48" and 60" wide units have one center support; 72" wide units have two supports; and 96" wide units have three supports. Powder coat medium gray finish.

Boltless Sloping Shelf Units

Ideal for light to medium duty applications (shelf load capacities up to 400 lbs.). Units can be placed back-to-back with shelves positioned in a reverse slope. A second back-to-back option allows the shelves to be positioned in a continuous slope. The 16-gauge shelves have a 2" wide side flange and a ½" high front lip that acts as a product stop. 18" deep shelves have a 14° slope and 24" deep shelves have a 12° slope. Each 84" high unit consists of five angled shelves and a flat canopy frame. Medium gray or sand finish.

Boltless Shelving Units

- Choose heavy-duty or medium-duty units.
- All units are 84" high.
- Available with several decking options.
- Heavy-duty units have 3 shelves and are available in 48", 72" and 96" widths.
- Shelves are adjustable up and down in 1½" increments.
- Add-On units are used with a starter unit to create a row of shelving.
- Assembly is easy with a rubber mallet.
- Shelf load capacities are based on evenly distributed loads.
- Shipped unassembled.
- Available in sand or medium gray finishes.



Particle Board Decking



Wire Decking

PARTICLEBOARD DECKING

W X D X H	Starter Units (3 levels)			Add-On Units (3 levels)		Extra Levels	
	CAT. NO.	LBS.	SHELF CAP. (LBS.)	CAT. NO.	LBS.	CAT. NO.	LBS.
48" x 24" x 84"	ZLE7-4824S-3D	118	2250	ZLE7-4824A-3D	117	ZLES-4824D	33
48" x 36" x 84"	ZLE7-4836S-3D	156	2250	ZLE7-4836A-3D	155	ZLES-4836D	46
48" x 48" x 84"	ZLE7-4848S-3D	195	2250	ZLE7-4848A-3D	194	ZLES-4848D	59
72" x 24" x 84"	ZLE7-7224S-3D	166	1750	ZLE7-7224A-3D	165	ZLES-7224D	49
72" x 36" x 84"	ZLE7-7236S-3D	222	1750	ZLE7-7236A-3D	221	ZLES-7236D	68
72" x 48" x 84"	ZLE7-7248S-3D	278	1750	ZLE7-7248A-3D	277	ZLES-7248D	86
96" x 24" x 84"	ZLE7-9624S-3D	212	1250	ZLE7-9624A-3D	212	ZLES-9624D	65
96" x 36" x 84"	ZLE7-9636S-3D	286	1250	ZLE7-9636A-3D	285	ZLES-9636D	89
96" x 48" x 84"	ZLE7-9648S-3D	360	1250	ZLE7-9648A-3D	359	ZLES-9648D	114

WIRE DECKING

W X D X H	Starter Units (3 levels)			Add-On Units (3 levels)		Extra Levels	
	CAT. NO.	LBS.	SHELF CAP. (LBS.)	CAT. NO.	LBS.	CAT. NO.	LBS.
48" x 24" x 84"	ZLE7-4824S-3W	90	2250	ZLE7-4824A-3W	89	ZLES-4824W	24
48" x 36" x 84"	ZLE7-4836S-3W	114	2250	ZLE7-4836A-3W	113	ZLES-4836W	32
48" x 48" x 84"	ZLE7-4848S-3W	138	2250	ZLE7-4848A-3W	137	ZLES-4848W	40
72" x 24" x 84"	ZLE7-7224S-3W	124	1750	ZLE7-7224A-3W	123	ZLES-7224W	35
72" x 36" x 84"	ZLE7-7236S-3W	159	1750	ZLE7-7236A-3W	158	ZLES-7236W	47
72" x 48" x 84"	ZLE7-7248S-3W	194	1750	ZLE7-7248A-3W	193	ZLES-7248W	58
96" x 24" x 84"	ZLE7-9624S-3W	155	1250	ZLE7-9624A-3W	155	ZLES-9624W	46
96" x 36" x 84"	ZLE7-9636S-3W	202	1250	ZLE7-9636A-3W	201	ZLES-9636W	61
96" x 48" x 84"	ZLE7-9648S-3W	246	1250	ZLE7-9648A-3W	245	ZLES-9648W	76

SHIPPING INFORMATION: 5 Days, F.O.B. Dickson, TN



Particle Board
Decking



Corrugated Steel
Decking



Flat Wire Decking

*Also available in 24" and 48" deep. Contact your Crown Branch for more information.

**Bulk Storage Rack is intended to be hand-loaded only.

Bulk Storage Rack

Bulk Storage Rack is one of Tennsco's most versatile storage solutions for heavy and large items. Assembles in minutes with no hardware or tools required. Ideal for bulky items, choose from particle board decking, corrugated steel decking, or wire decking. Shelves support up to 4,000 lbs., evenly distributed, depending on size.

Particle Board

Industrial Grade 5/8" thick provides an economical deck.

Corrugated Decking

22 gauge steel provides a smooth solid surface to store item.

Flat Wire

Allows sufficient light and airflow.

Shelf Levels

Includes (1) pair of beams, decking, and require quantity of reinforcements.

RACK & SHELVING

PARTICLE BOARD DECKING											
Starter Units (3 Levels)				Add-On Units (3 Levels)		Extra Shelf Levels					
W	X	D	X	H	CAT. NO	WEIGHT	SHELF CAP. (LBS.)	CAT. NO	WEIGHT	CAT. NO	WEIGHT
48"	X	36"	X	72"	BU-483672PS	193	1,500	BU-483672PA	171	BU-4836P	50
72"	X	36"	X	72"	BU-723672PS	260	2,750	BU-723672PA	238	BU-7236P	72
96"	X	36"	X	72"	BU-963672PS	335	2,150	BU-963672PA	313	BU-9636P	97
48"	X	36"	X	96"	BU-483696PS	209	1,500	BU-483696PA	179	BU-4836P	50
72"	X	36"	X	96"	BU-723696PS	276	2,750	BU-963696PA	246	BU-7236P	72
96"	X	36"	X	96"	BU-963696PS	351	2,150	BU-963696PA	321	BU-9636P	97
48"	X	36"	X	120"	BU-4836120PS	221	1,500	BU-4836120PA	185	BU-4836P	50
72"	X	36"	X	120"	BU-7236120PS	288	2,750	BU-7236120PA	252	BU-7236P	72
96"	X	36"	X	120"	BU-9636120PS	363	2,150	BU-9636120PA	327	BU-9636P	97

CORRUGATED STEEL DECKING											
Starter Units (3 Levels)				Add-On Units (3 Levels)		Extra Shelf Levels					
W	X	D	X	H	CAT. NO	WEIGHT	SHELF CAP. (LBS.)	CAT. NO	WEIGHT	CAT. NO	WEIGHT
48"	X	36"	X	72"	BU-483672CS	163	1,500	BU-483672CA	141	BU-4836C	40
72"	X	36"	X	72"	BU-723672CS	218	2,750	BU-723672CA	196	BU-7236C	58
96"	X	36"	X	72"	BU-963672CS	275	2,150	BU-963672CA	253	BU-9636C	77
48"	X	36"	X	96"	BU-483696CS	179	1,500	BU-483696CA	149	BU-4836C	40
72"	X	36"	X	96"	BU-723696CS	234	2,750	BU-963696CA	204	BU-7236C	58
96"	X	36"	X	96"	BU-963696CS	291	2,150	BU-963696CA	261	BU-9636C	77
48"	X	36"	X	120"	BU-4836120CS	191	1,500	BU-4836120CA	155	BU-4836C	40
72"	X	36"	X	120"	BU-7236120CS	246	2,750	BU-7236120CA	210	BU-7236C	58
96"	X	36"	X	120"	BU-9636120CS	303	2,150	BU-9636120CA	267	BU-9636C	77

FLAT WIRE DECKING											
Starter Units (3 Levels)				Add-On Units (3 Levels)		Extra Shelf Levels					
W	X	D	X	H	CAT. NO	WEIGHT	SHELF CAP. (LBS.)	CAT. NO	WEIGHT	CAT. NO	WEIGHT
48"	X	36"	X	72"	BU-483672WS	148	1,500	BU-483672WA	126	BU-4836W	35
72"	X	36"	X	72"	BU-723672WS	197	2,750	BU-723672WA	175	BU-7236W	51
96"	X	36"	X	72"	BU-963672WS	251	2,150	BU-963672WA	229	BU-9636W	69
48"	X	36"	X	96"	BU-483696WS	164	1,500	BU-483696WA	134	BU-4836W	35
72"	X	36"	X	96"	BU-723696WS	213	2,750	BU-963696WA	183	BU-7236W	51
96"	X	36"	X	96"	BU-963696WS	267	2,150	BU-963696WA	237	BU-9636W	69

Spider® Shelving System — 75" High With 5 Shelves

	Open Starters	Open Add-Ons	Closed Starters	Closed Add-Ons
W X D	CAT. NO.	CAT. NO.	CAT. NO.	CAT. NO.
36" x 18"	SHD1002	SHA1002	SHD2002	SHA2002
36" x 24"	SHD1003	SHA1003	SHD2003	SHA2003
48" x 18"	SHD1032	SHA1032	SHD2032	SHA2032
48" x 24"	SHD1033	SHA1033	SHD2033	SHA2033

Spider® Shelving System — 87" High With 5 Shelves

	Open Starters	Open Add-Ons	Closed Starters	Closed Add-Ons
W X D	CAT. NO.	CAT. NO.	CAT. NO.	CAT. NO.
36" x 18"	SHD1005	SHA1005	SHD2005	SHA2005
36" x 24"	SHD1006	SHA1006	SHD2006	SHA2006
48" x 18"	SHD1035	SHA1035	SHD2035	SHA2035
48" x 24"	SHD1036	SHA1036	SHD2036	SHA2036



Spider® Shelving System

- Sturdy construction and quick assembly
 - Several dimensions available: 36", 42" and 48" W by 18" and 24" D
 - Super functional common post with fixing zones
 - Drawers can be installed in over 35 brands of shelving on the market
 - 400 lb. capacity per drawer
 - Allows you to combine units for small, medium and large parts
- Accessories:
- Doors
 - Dividers
 - Label holders
 - Perforated panels
 - Louvered panels
 - Hooks
 - Clothes hanging rail
 - Spool support

The unique design of the Spider® Shelving post is a copyright of Rousseau Metal Inc.

SHIPPING INFORMATION:
3-5 Weeks
F.O.B. Williston, VT

Extra Shelves for Spider® Shelving System

CAT. NO.	W X D
SH20-3618	36" x 18"
SH20-3624	36" x 24"
SH20-4818	48" x 18"
SH20-4824	48" x 24"

Mobile Shelving & Mini-Racking

Many Shelving and Mini-Racking units can be made mobile. Please contact your Crown representative for more information.



LED Light for Spider® Shelving

CAT. NO.	FITS ON
SH95-01	30" or 36" W Shelves
SH95-02	42" or 48" W Shelves



Eliminates shaded areas between shelves



Open Starter



Closed Starter



Mini-Racking with Steel Decking



Mini-Racking with Wire Decking

Mini-Racking — 75" High With 4 Levels/Steel Decking and Wire Decking

	Steel Decking Starters	Steel Decking Add-Ons	Wire Decking Starters	Wire Decking Add-Ons
W X D	CAT. NO.	CAT. NO.	CAT. NO.	CAT. NO.
48" x 24"	SRD5022S	SRA5022S	—	—
48" x 36"	SRD5023S	SRA5023S	SRD5023W	SRA5023W
48" x 48"	—	—	SRD5024W	SRA5024W
60" x 24"	SRD5072S	SRA5072S	—	—
60" x 36"	SRD5073S	SRA5073S	—	—
72" x 36"	SRD5123S	SRA5123S	SRD5123W	SRA5123W
72" x 48"	SRD5124S	SRA5124S	SRD5124W	SRA5124W
96" x 24"	SRD5222S	SRA5222S	—	—
96" x 36"	SRD5223S	SRA5223S	SRD5223W	SRA5223W
96" x 48"	—	—	SRD5224W	SRA5224W

Mini-Racking — 87" High With 4 Levels/Steel Decking and Wire Decking

	Steel Decking Starters	Steel Decking Add-Ons	Wire Decking Starters	Wire Decking Add-Ons
W X D	CAT. NO.	CAT. NO.	CAT. NO.	CAT. NO.
48" x 24"	SRD5026S	SRA5026S	—	—
48" x 36"	SRD5027S	SRA5027S	SRD5027W	SRA5027W
48" x 48"	—	—	SRD5028W	SRA5028W
60" x 24"	SRD5076S	SRA5076S	—	—
60" x 36"	SRD5077S	SRA5077S	—	—
72" x 36"	SRD5127S	SRA5127S	SRD5127W	SRA5127W
72" x 48"	SRD5128S	SRA5128S	SRD5128W	SRA5128W
96" x 24"	SRD5226S	SRA5226S	—	—
96" x 36"	SRD5227S	SRA5227S	SRD5227W	SRA5227W
96" x 48"	—	—	SRD5228W	SRA5228W



Drawer in Shelving

Shelving with modular drawers can eliminate problems such as poorly lit shelves and difficulty accessing materials. The modular drawers have a 400-lb. capacity and can be installed in more than 35 brands of shelving.

With sturdy construction and a distinctive appearance, Rousseau drawers are available in widths of 36", 42" and 48", and depths of 18" and 24". Four standard bank heights are available: 18", 24", 36" and 48". Your storage system will evolve with the pace of your business by adding drawers to your existing shelving units.

The unique design of the R Drawer is a copyright of Rousseau Metal Inc.

A. Shelving Unit with 18" Drawers

- Welded closed uprights with drawers and shelves
- Drawer sizes: three 4" and one 6"
- Bank of drawers includes mounting brackets; does not include shelving

	75" H WITH DRAWERS	87" H WITH DRAWERS	18" BANK OF DRAWERS
W X D	CAT. NO.	CAT. NO.	CAT. NO.
36" x 18"	R5SEC-751801	R5SEC-871801	R5LEC-1801
36" x 24"	R5SEE-751801	R5SEE-871801	R5LEE-1801
48" x 18"	R5SHC-751801	R5SHC-871801	R5LHC-1801
48" x 24"	R5SHE-751801	R5SHE-871801	R5LHE-1801



A.

B. Shelving Unit with 24" Drawers

- Welded closed uprights with drawers and shelves
- Drawer sizes: three 4" and two 6"
- Bank of drawers includes mounting brackets; does not include shelving

	75" H WITH DRAWERS	87" H WITH DRAWERS	24" BANK OF DRAWERS
W X D	CAT. NO.	CAT. NO.	CAT. NO.
36" x 18"	R5SEC-752401	R5SEC-872401	R5LEC-2401
36" x 24"	R5SEE-752401	R5SEE-872401	R5LEE-2401
48" x 18"	R5SHC-752401	R5SHC-872401	R5LHC-2401
48" x 24"	R5SHE-752401	R5SHE-872401	R5LHE-2401



B.

C. Shelving Unit with 36" Drawers

- Welded closed uprights with drawers and shelves
- Drawer sizes: three 4" and four 6"
- Bank of drawers includes mounting brackets; does not include shelving

	75" H WITH DRAWERS	87" H WITH DRAWERS	36" BANK OF DRAWERS
W X D	CAT. NO.	CAT. NO.	CAT. NO.
36" x 18"	R5SEC-753601	R5SEC-873601	R5LEC-3601
36" x 24"	R5SEE-753601	R5SEE-873601	R5LEE-3601
48" x 18"	R5SHC-753601	R5SHC-873601	R5LHC-3601
48" x 24"	R5SHE-753601	R5SHE-873601	R5LHE-3601



C.

D. Shelving Unit with 48" Drawers

- Welded closed uprights with drawers and shelves
- Drawer sizes: eight 6"
- Bank of drawers includes mounting brackets; does not include shelving

	75" H WITH DRAWERS	87" H WITH DRAWERS	48" BANK OF DRAWERS
W X D	CAT. NO.	CAT. NO.	CAT. NO.
36" x 18"	R5SEC-754801	R5SEC-874801	R5LEC-4801
36" x 24"	R5SEE-754801	R5SEE-874801	R5LEE-4801
48" x 18"	R5SHC-754801	R5SHC-874801	R5LHC-4801
48" x 24"	R5SHE-754801	R5SHE-874801	R5LHE-4801



D.

RACK & SHELVING

Standard Colors

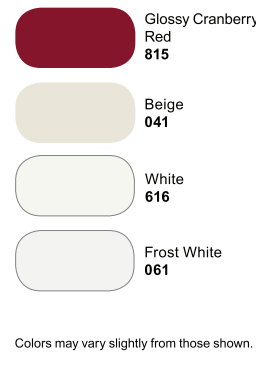
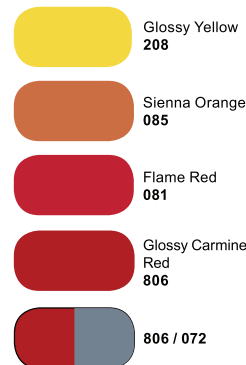
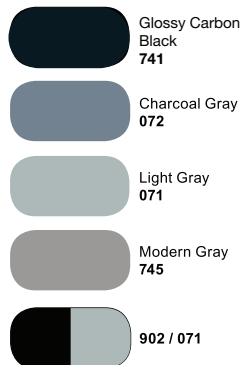
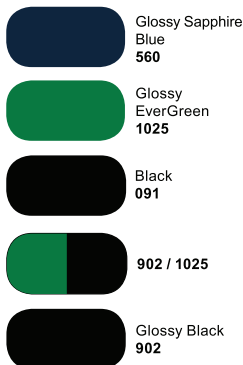
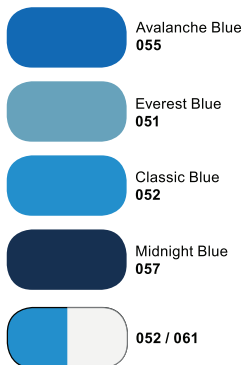

Colors may vary slightly from those shown.

SHIPPING INFORMATION: 3-5 Weeks, F.O.B. Williston, VT



RivetRite® Shelving - Double Rivet Units - 723 Light Putty

RivetRite Shelving

- 48" to 96" wide beams
- Access to stored items from all sides
- Choice of Double Rivet or Single Rivet beam construction
- Easy assembly without special tools
- Units available in 84" and 120" heights
- 723 Light Putty Powdercoat finish

Double Rivet Units (w/o Center Support)

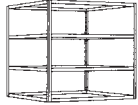

4 Shelf Starter Unit, 48" Wide

W X D X H	CAT. NO.	LBS.
48" x 18" x 84"	46001HP	59.2
48" x 24" x 84"	46002HP	62.4
48" x 30" x 84"	46003HP	65.6
48" x 36" x 84"	46004HP	68.0
48" x 48" x 84"	46005HP	80.0

4 Shelf Starter Unit, 60" Wide

W X D X H	CAT. NO.	LBS.
60" x 18" x 84"	46011HP	66.4
60" x 24" x 84"	46012HP	69.6
60" x 30" x 84"	46013HP	72.8
60" x 36" x 84"	46014HP	75.2
60" x 48" x 84"	46015HP	87.2

4 Shelf Starter Unit, 72" Wide

W X D X H	CAT. NO.	LBS.
72" x 18" x 84"	46021HP	74.4
72" x 24" x 84"	46022HP	77.6
72" x 30" x 84"	46023HP	80.8
72" x 36" x 84"	46024HP	83.2
72" x 48" x 84"	46025HP	95.2

4 Shelf Add-On Unit, 48" Wide

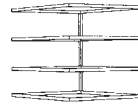

W X D X H	CAT. NO.	LBS.
48" x 18" x 84"	46006HP	57.2
48" x 24" x 84"	46007HP	60.4
48" x 30" x 84"	46008HP	63.6
48" x 36" x 84"	46009HP	66.0
48" x 48" x 84"	46010HP	78.0

4 Shelf Add-On Unit, 60" Wide

W X D X H	CAT. NO.	LBS.
60" x 18" x 84"	46016HP	64.4
60" x 24" x 84"	46017HP	67.6
60" x 30" x 84"	46018HP	70.8
60" x 36" x 84"	46019HP	73.2
60" x 48" x 84"	46020HP	85.2

4 Shelf Add-On Unit, 72" Wide

W X D X H	CAT. NO.	LBS.
72" x 18" x 84"	46026HP	72.4
72" x 24" x 84"	46027HP	75.6
72" x 30" x 84"	46028HP	78.8
72" x 36" x 84"	46029HP	81.2
72" x 48" x 84"	46030HP	93.2

5 Shelf Starter Unit, 72" Wide

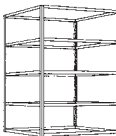

W X D X H	CAT. NO.	LBS.
72" x 30" x 120"	46041HP	104.2
72" x 36" x 120"	46042HP	107.2
72" x 48" x 120"	46043HP	122.2

5 Shelf Add-On Unit, 72" Wide

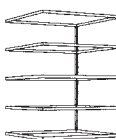

W X D X H	CAT. NO.	LBS.
72" x 30" x 120"	46044HP	101.6
72" x 36" x 120"	46045HP	104.6
72" x 48" x 120"	46046HP	119.6

NOTES

- Double Rivet Beams 48" or longer in these units are Heavy Duty; all others are Standard Beams.
- All Unit Catalog Numbers are for Steel Framing only.
- Shelf deck material must be obtained separately.

Double Rivet Units (w/Center Support)

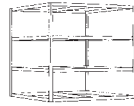

4 Shelf Starter Unit, 48" Wide

W X D X H	CAT. NO.	LBS.
48" x 18" x 84"	46W01HP	64.8
48" x 24" x 84"	46W02HP	69.6
48" x 30" x 84"	46W03HP	74.4
48" x 36" x 84"	46W04HP	78.8
48" x 48" x 84"	46W05HP	94.0

4 Shelf Starter Unit, 60" Wide

W X D X H	CAT. NO.	LBS.
60" x 18" x 84"	46W11HP	72.0
60" x 24" x 84"	46W12HP	76.8
60" x 30" x 84"	46W13HP	81.6
60" x 36" x 84"	46W14HP	86.0
60" x 48" x 84"	46W15HP	101.2

4 Shelf Starter Unit, 72" Wide

W X D X H	CAT. NO.	LBS.
72" x 18" x 84"	46W21HP	80.0
72" x 24" x 84"	46W22HP	84.8
72" x 30" x 84"	46W23HP	89.6
72" x 36" x 84"	46W24HP	94.0
72" x 48" x 84"	46W25HP	109.2

4 Shelf Starter Unit, 96" Wide

W X D X H	CAT. NO.	LBS.
96" x 18" x 84"	46W31HP	100.0
96" x 24" x 84"	46W32HP	106.4
96" x 30" x 84"	46W33HP	112.8
96" x 36" x 84"	46W34HP	119.2
96" x 48" x 84"	46W35HP	137.6

4 Shelf Add-On Unit, 48" Wide

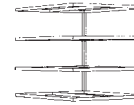

W X D X H	CAT. NO.	LBS.
48" x 18" x 84"	46W06HP	62.8
48" x 24" x 84"	46W07HP	67.6
48" x 30" x 84"	46W08HP	72.4
48" x 36" x 84"	46W09HP	76.8
48" x 48" x 84"	46W10HP	92.0

4 Shelf Add-On Unit, 60" Wide

W X D X H	CAT. NO.	LBS.
60" x 18" x 84"	46W16HP	70.0
60" x 24" x 84"	46W17HP	74.8
60" x 30" x 84"	46W18HP	79.6
60" x 36" x 84"	46W19HP	84.0
60" x 48" x 84"	46W20HP	99.2

4 Shelf Add-On Unit, 72" Wide

W X D X H	CAT. NO.	LBS.
72" x 18" x 84"	46W26HP	78.0
72" x 24" x 84"	46W27HP	82.8
72" x 30" x 84"	46W28HP	87.6
72" x 36" x 84"	46W29HP	92.0
72" x 48" x 84"	46W30HP	107.2

4 Shelf Add-On Unit, 96" Wide

W X D X H	CAT. NO.	LBS.
96" x 18" x 84"	46W36HP	98.0
96" x 24" x 84"	46W37HP	104.4
96" x 30" x 84"	46W38HP	110.8
96" x 36" x 84"	46W39HP	117.2
96" x 48" x 84"	46W40HP	135.6

5 Shelf Starter Unit, 72" Wide



W X D X H	CAT. NO.	LBS.
72" x 30" x 120"	46W41HP	115.2
72" x 36" x 120"	46W42HP	120.7
72" x 48" x 120"	46W43HP	139.7

5 Shelf Starter Unit, 96" Wide

W X D X H	CAT. NO.	LBS.
96" x 30" x 120"	46W47HP	144.2
96" x 36" x 120"	46W48HP	152.2
96" x 48" x 120"	46W49HP	175.2

5 Shelf Add-On Unit, 72" Wide

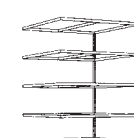

W X D X H	CAT. NO.	LBS.
72" x 30" x 120"	46W44HP	112.6
72" x 36" x 120"	46W45HP	118.1
72" x 48" x 120"	46W46HP	137.1

5 Shelf Add-On Unit, 96" Wide

W X D X H	CAT. NO.	LBS.
96" x 30" x 120"	46W50HP	141.6
96" x 36" x 120"	46W51HP	149.6
96" x 48" x 120"	46W52HP	172.6

SHIPPING INFORMATION:
84" high units F.O.B. Fort Wayne, IN;
Units higher than 84" F.O.B. Hamilton, NC

Dynamic high density storage for faster each picks

- Increases storage density by 40-60%
- Reduces labor costs up to 40%
- Transforms space into useable storage
- More SKUs - Less Space - Greater Efficiency
- Ergonomically designed



SpeedCell Bays

96" x 42/48"			
W" x D" x T"	Height	Cells	Model
11.5 x 12 x 78	13	6	SCB96-12-126LFND
11.5 x 12 x 78	11.14	7	SCB96-12-147LFND
11.5 x 12 x 78	9.75	8	SCB96-12-168LFND
11.5 x 12 x 78	8.67	9	SCB96-12-189LFND
11.5 x 12 x 78	7.8	10	SCB96-12-210LFND
11.5 x 12 x 78	7.09	11	SCB96-12-231LFND
11.5 x 12 x 78	6.5	12	SCB96-12-252LFND



- Heavy gauge steel construction
- Increase space utilization by up to 50%
- Reconfigurable storage to accommodate process changes
- Compatible with all Span-Track products
- 7-year warranty

FlowCell Starter Units

W" x D" x H"	Levels	Roller	Wheelbed
72x48x72	3	FC99SR72483-S	FC99SW72483-S
72x48x72	4	FC99SR72484-S	FC99SW72484-S
72X72X72	3	FC99SR72723-S	FC99SW72723-S
72X72X72	4	FC99SR72724-S	FC99SW72724-S

FlowCell Mobile Units

36x48x54	3	FCM99sr36483	FCM99SW36483
36x60x54	4	FCM99sr36603	FCM99SW36603
36X72X54	3	FCM99SR36723	FCM99SW36723
48X48X54	3	FCM99SR48483	FCM99SW48483
48X60X54	3	FCM99SR48603	FCM99SW48603
48X72X54	3	FCM99SR48723	FCM99SW48723

For custom sizes or add-on units, please contact Crown

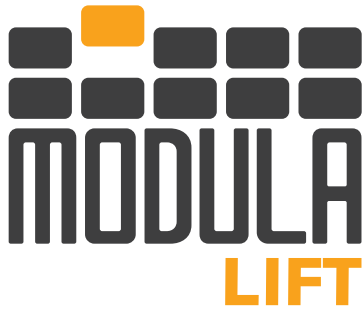

THE IDEAL SOLUTION FOR ALL POSSIBLE APPLICATIONS

Recover up to **90%** of valuable floor space. Increase the **speed, efficiency, accuracy** of your picking operations.

Technical highlights

Unit heights

10'10" - 52'10"

Net tray payload

551 - 2,182 lbs

Tray widths

59 - 75 - 98 - 122 - 161"

Throughput of up to **140 trays/hour**

Tray payload capacity of up to **2,200 lbs**

Internal, external, single or dual delivery bay

3 Bay heights
27.36" - 35.23"
50.98"

Simple & intuitive Software
10.4" touch screen operator console

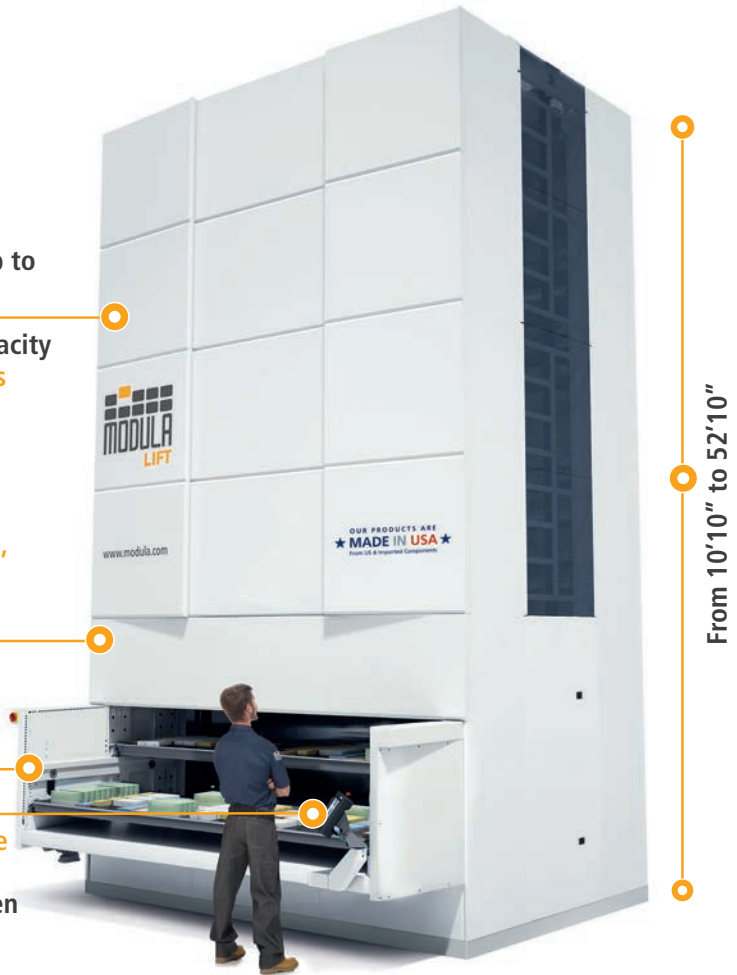

From 10'10" to 52'10"

RACK & SHELVING

As much as **9,050 sq. ft.** of storage in **only 150 sq. ft.**

154,500 lbs gross unit load capacity



Up to **300 lines** per hour



HIGH-PERFORMANCE ORDER FULFILLMENT IN LOW CEILING ENVIRONMENTS

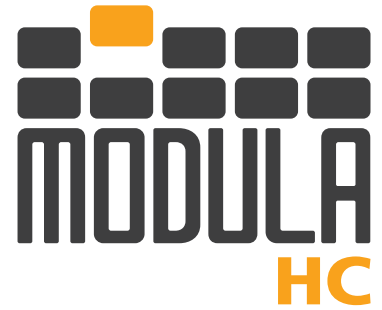

Adjustable shelf spacing of 2"

Bin capacity up to 1,200 lbs

Shelf capacity up to 250 lbs

Building on a 30 year legacy, Modula HC brings a new level of **performance, reliability, safety.**

Technical highlights

Bin width

24" or 36"

Bin depth

18" or 24"

Bin height:

84" or 96"



Automatic safety doors & 6-foot-high fencing on all models

Simply and Intuitive Interface



RACK & SHELVING

High productivity
with carousels in pod

One WMS Platform
to operate all Modula products



Up to **500 lines**
per hour





Work Assist Vehicle

Designed and manufactured by Crown to help people work faster and safer.

- Works efficiently and quietly in almost any indoor application
- Elevates a person to nearly 10 ft.
- Travels nearly twice as fast as the average walking speed
- Navigates easily in the tightest working spaces

Specifications

- Operator pick height: 17 ft.
- Load tray capacity: 200 lbs.
- Vehicle weight: 1420 lbs.
- 24 volt electrical system with built-in charger
- Optional power load tray
- Optional lithium-ion power source

CALL FOR A FREE DEMONSTRATION



RACK & SHELVING

SHIPPING INFORMATION: 2-6 Weeks, F.O.B. New Bremen, OH



Mighty Line Floor Tapes

Mighty Line® patented floor tape is the most durable floor tape available. Spend more time on value added actions—producing, receiving, and shipping materials—and less time on non-value added activities such as painting floor lines. Mighty Line floor tape is available in many colors and patterns in four different widths.

Benefits of Mighty Line!

- Separating pedestrian traffic from motorized vehicles.
- Illuminating walkways during power failures.
- 5S lean manufacturing improvements.
- Color code different areas with specific color tapes.
- Easy to install and lasts!
- 3 year limited warranty.

Mighty Glow Floor Tapes

Mighty Glow® a unique floor tape developed for emergency purposes. Mighty Glow's ½" luminescent center line high-lights exit paths during power outages.

Mighty Line Solid Colored Floor Tapes

CAT. NO.	SIZE	DESCRIPTION
● 351097-042	2" x 100'	Solid Yellow Floor Tape
● 351097-093	3" x 100'	Solid Yellow Floor Tape
● 351097-130	4" x 100'	Solid Yellow Floor Tape
● 351097-010	2" x 100'	Solid Red Floor Tape
● 351097-063	3" x 100'	Solid Red Floor Tape
● 351097-124	4" x 100'	Solid Red Floor Tape
○ 351097-012	2" x 100'	Solid White Floor Tape
○ 351097-064	3" x 100'	Solid White Floor Tape
○ 351097-126	4" x 100'	Solid White Floor Tape
● 351097-005	2" x 100'	Solid Green Floor Tape
● 351097-060	3" x 100'	Solid Green Floor Tape
● 351097-119	4" x 100'	Solid Green Floor Tape
● 351097-002	2" x 100'	Solid Blue Floor Tape
● 351097-057	3" x 100'	Solid Blue Floor Tape
● 351097-116	4" x 100'	Solid Blue Floor Tape
● 351097-001	2" x 100'	Solid Black Floor Tape
● 351097-056	3" x 100'	Solid Black Floor Tape
● 351097-115	4" x 100'	Solid Black Floor Tape
● 351097-004	2" x 100'	Solid Gray Floor Tape
● 351097-059	3" x 100'	Solid Gray Floor Tape
● 351097-118	4" x 100'	Solid Gray Floor Tape
● 351097-006	2" x 100'	Solid Orange Floor Tape
● 351097-061	3" x 100'	Solid Orange Floor Tape
● 351097-120	4" x 100'	Solid Orange Floor Tape

Mighty Line Diagonal Striped Floor Tapes

CAT. NO.	SIZE	DESCRIPTION
● 351097-044	2" x 100'	Yellow w/bk diagonals
● 351097-094	3" x 100'	Yellow w/bk diagonals
● 351097-132	4" x 100'	Yellow w/bk diagonals
○ 351097-013	2" x 100'	White w/bk diagonals
○ 351097-065	3" x 100'	White w/bk diagonals
○ 351097-127	4" x 100'	White w/bk diagonals
○ 351097-014	2" x 100'	White w/red diagonals
○ 351097-066	3" x 100'	White w/red diagonals
○ 351097-128	4" x 100'	White w/red diagonals

Mighty Line Specialty Floor Tapes

CAT. NO.	SIZE	DESCRIPTION
● 351097-041	4" x 100'	Yellow w/Glow Center
● 351097-194	4" x 100'	Yellow Frigid Freezer

Safety YELLOW - Caution: Pedestrian Aisle Ways

Safety RED - Safety Areas – Emergency Exit Ways and Do Not Block Fire Extinguishers

Safety WHITE - Production Equipment – Machines, Carts, Incoming Racks

Safety GREEN - Safety Related Equipment/Raw Material Areas – Eye Wash Stations & Spillage Showers

Safety ORANGE - Parts for Machinery Area

Safety BLUE - Work in Process Area or Equipment Under Repair Zone

Safety BLACK - Finished Goods Area

Safety YELLOW/BLACK - Extra Caution Areas – Pedestrian Walkways or Aisle Ways

Safety RED/WHITE - Safety Equipment Areas – Fire Extinguishers, Electrical Panels, AED Machines, etc.



Mighty Line 5s Floor Color Recommendations

Use Mighty Line safety tapes, floor markers, and safety floor signs to identify, communicate, and reinforce proper safety practices.

Your facility will shine with the proper placement inventory tools, and machinery identified with brightly colored Mighty Line floor tapes, markers and signs.

Set things in order by using different color Mighty Line floor tapes and floor markings to show work flow patterns, establish borders between work areas and mark the proper placement of tools, inventories, and machinery. Sort your critical work areas and crucial inventory areas with Mighty line floor tape and floor markers to obtain optimal production.

Sustain your 5s implementation by standardizing your 5s procedures and using the same Mighty Line floor tape products for certain areas throughout the facility.

SHIPPING INFORMATION: 9-10 Days, F.O.B. Wadsworth, OH



Mighty Line Floor Tapes

Mighty Line® patented floor tape is the most durable floor tape available. Spend more time on value added actions—producing, receiving, and shipping materials—and less time on non-value added activities such as painting floor lines. Mighty Line floor tape is available in many colors, patterns and four different widths.

Benefits of Mighty Line!

- Separating pedestrian traffic from motorized vehicles.
- Illuminating walkways during power failures.
- 5S lean manufacturing improvements.
- Color code different areas with specific color tapes.
- Easy to install and lasts!
- 3-year limited warranty.

Mighty Line Angles

Mighty Line Angles aid in 5S practices and are used for the proper placement of inventory, equipment and vehicles.

Mighty Line Floor Signs

Mighty Line Safety Signs reinforce safe activities throughout your facility. Mighty Line floor signs are available in a variety of shapes and sizes.

Mighty Line Label Protectors

Mighty Line clear Label Protectors are used to prolong the life of your floor location labels.

Mighty Line Cleaner

Mighty Line offers an all purpose heavy duty cleaner and degreaser that can be used for any cleaning purpose.



Mighty Line 5S Angles

CAT. NO.	SIZE	DESCRIPTION	QTY
351097-037-01	6" x 6" x 2"	Solid Yellow Angle	1
351097-029-01	6" x 6" x 2"	Solid Red Angle	1
351097-031-01	6" x 6" x 2"	Solid White Angle	1
351097-023-01	6" x 6" x 2"	Solid Green Angle	1
351097-015-01	6" x 6" x 2"	Solid Black Angle	1
351097-021-01	6" x 6" x 2"	Solid Gray Angle	1
351097-025-01	6" x 6" x 2"	Solid Orange Angle	1

CAT. NO.	SIZE	DESCRIPTION	QTY
351097-027-01	6" x 6" x 2"	Solid Purple Angle	1
351097-019-01	6" x 6" x 2"	Solid Brown Angle	1
351097-017-01	6" x 6" x 2"	Solid Blue Angle	1
351097-038-01	6" x 6" x 2"	Yellow/bk Diagonals	1
351097-032-01	6" x 6" x 2"	White/bk Diagonals	1
351097-033-01	6" x 6" x 2"	White/red Diagonals	1



Mighty Line Floor Signs

CAT. NO.	SIZE	DESCRIPTION
351097-208	24" x 36"	Keep Clear Do Not Block
351097-205	24" x 24"	STOP
351097-223	48" x 48"	STOP
351097-206	24" x 36"	Do Not Block Fire Ext.
351097-224	24" x 24"	Trash Can Floor Sign



Mighty Line Specialty Products

CAT. NO.	SIZE	DESCRIPTION	QTY
351097-165-01	10" x 6"	Clear Label Protectors	1
351097-364		2", 3", and 4" Tape Applicator	1
351097-164	1 Gallon	Heavy Duty Degreaser Cleaner	1



SHIPPING INFORMATION: 9-10 Days, F.O.B. Wadsworth, OH



A MODERN SOLUTION FOR YOUR SIGNAGE CHALLENGES

Durable. Flexible. Safe.

These signs and equipment can be used in rugged conditions within high traffic and high-risk areas, on moving equipment and in low light environments. Use in wet, cold humid, or dusty environments where painted and adhesive signage can wear off quickly. Increase safety with projected signage that withstands both foot and vehicle traffic.

- Improve OSHA compliance and safety
- UL approved (PCE-series projectors)
- Minimize maintenance costs
- Works where paint and tape is impractical
- Active signage = better visibility
- Easy in-house installation



Eco Spot PCE Series Projectors

- For Rugged, Dusty and Wet Environments
- Passive cooling, no fans or motors
- Long service intervals
- Power 20-300W, 95-277V
- UL/cUL rated for wet environments



Sign Projector Options:

- C20PCE: Specs for Bright Conditions
Sign Size: up to 3' / Projection Dist.: up to 16'
- C40PCE: Specs for Bright Conditions
Sign Size: up to 4' / Projection Dist.: up to 32'
- C60PCE: Specs for Bright Conditions
Sign Size: up to 6' / Projection Dist.: up to 40'
- B90PCE: Specs for Bright Conditions
Sign Size: up to 9' / Projection Dist.: up to 40'
- B150PCE: Specs for Bright Conditions
Sign Size: up to 12' / Projection Dist.: up to 48'

ECO Lines Virtual LED Projectors

ECO Lines Virtual Line LED Projectors project a 4 to 6 inch thick, permanent floor line that eliminates the need for repainting. Compared to laser projectors, the lines are much thicker. ECO Lines projectors are designed for rugged and wet environments and require no maintenance.



SAFETY



PROJECTED VS TRADITIONAL SIGNAGE

Compare	Projected Signage	Traditional Signage (Paint or Adhesive)
Longevity	Long: Life of the projector (6+ yrs*)	Short: 3-9 months*
Maintenance	Low: Inexpensive and fast. Minimal impact on production.	High: Expensive and time intensive. Significantly slows or halts production.
Cost	Low: \$500 to \$6k one-time investment*. Typical ROI time 1-2 yrs*	High: \$1k to \$4k annually*
Visibility	Excellent: Active projection = better visibility. Blinking, rotating, and motion sensor capabilities can further enhance visibility.	Limited: Workers become accustomed to traditional signage. Worn signage is hard to see.
Durability	High: No wear and tear from foot or vehicle traffic. Stands up to humidity, cold, and dirt.	Low: Foot and vehicle traffic wears off both adhesive and painted signage.
Flexibility	High: Swap out the gobo to change signage or just reposition.	Limited: Signs must be scraped off and reapplied.

PROJECTED SOLUTION



TRADITIONAL SOLUTION



*Based on typical scenarios, the outcome may vary widely depending on specific applications.

SIGN OPTIONS

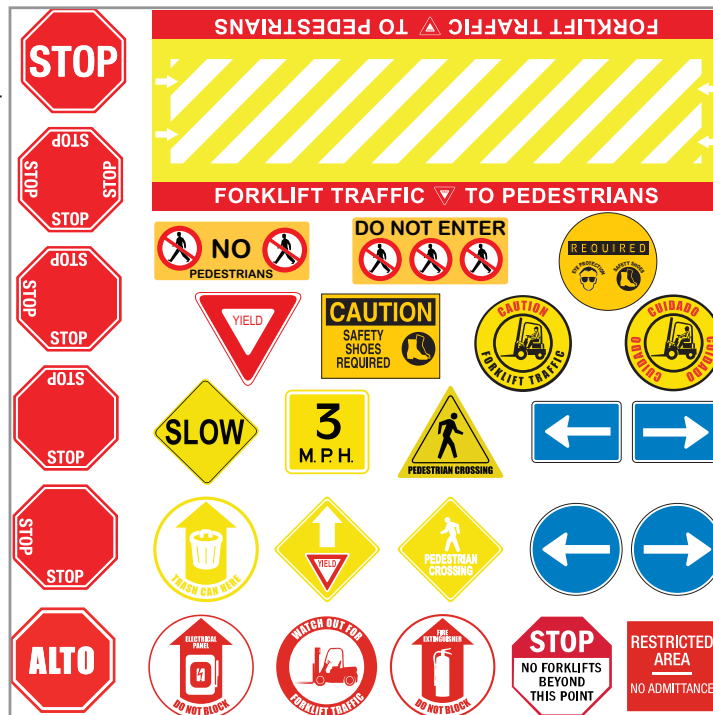

SAFETY



Projection of safety images, speed zones, pedestrian crossings, company logos on floor (with examples of projected images).

- Large projection sizes and distances
- Highly efficient design
- Interchangeable projection lenses
- Various projectors available – Please contact Crown for specific requirements



APPLICATIONS



Walkways

- Typical size 10-15 ft.
- Projector power 90-300W
- Typical projector distance 10-42 ft.

Laser Walkways / Thruways



Large Intersections

- Spans longer than 15 ft. are done with multiple projectors

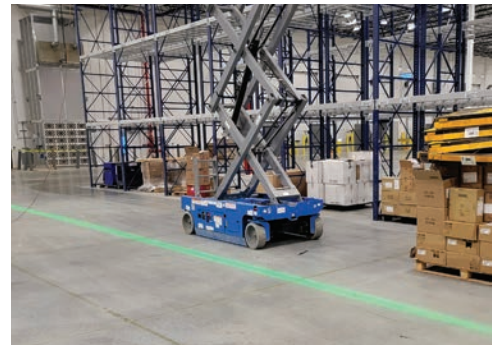

Signs

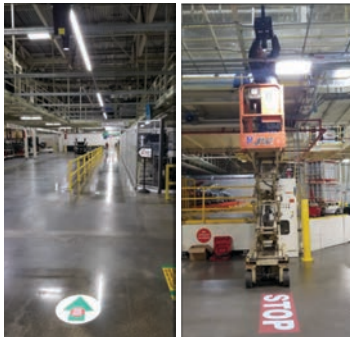

Small

- Sign size 2-5 ft.
- Projector power 25-60W
- Typical projector distance 6-36 ft.

Large

- Typical size 6-12 ft.
- Projector power 90-150W
- Typical projector distance 10-36 ft.





Corner Sentry™

Corner Sentry is the only energy absorbing corner protector that bounces back to retain its shape impact after impact. Ultra-flexible and molded from an EVA polymer, Corner Sentry installs using fasteners (not included) through integrated grommet recess, adhesives, or by strapping around included belt recess.

Park Sentry®

Park Sentry is the original, minimal footprint bump-n-go column protector for parking applications. Molded from proprietary ARPRO® material. Available in square, round and wall configurations in standard yellow or black. All sizes 39.3" tall.

Square: Four corners, four panels interlock to surround square or rectangular columns. Standard product fits 24" x 24" column. Customizable.

Round: Shaped to wrap around any diameter round column. Panels come with integrated tab and slot system and can be cut to any diameter. Layer for additional protection.

Wall System: Provides a tough layer of protection to walls vulnerable to vehicle collision damage. Adheres to the space using pre-mounted wall clips (purchased separately).

Rack Sentry®

The original impact-absorbing rack upright protector. Molded of ultra-flexible EVA polymer, the product absorbs impact to reduce or eliminate forklift collision damage. This product is easily attached to the rack by two nylon straps with hook-n-loop fasteners. Five widths and three configurations mean Rack Sentry fits on virtually any pallet rack upright.



Corner Sentry

- Corner Sentry is a 90° corner protector
- 42" tall
- Projects 4" from each corner
- With 4 recessed grommet holes



CAT. NO.	DESCRIPTION	LBS.
CNR42	4" x 4"	6.5

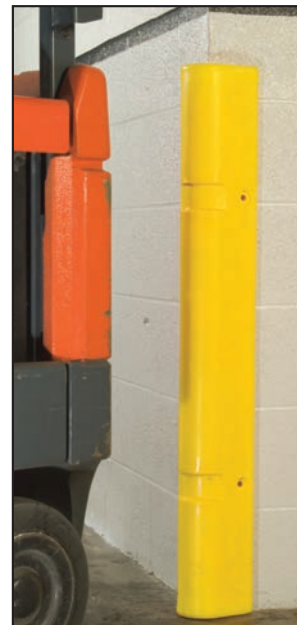

Park Sentry

Square: 4 corners, 4 panels; covers 24" x 24" square column.

Round: 3 panels; covers 24" diameter column (1 layer).

CAT. NO.	DESCRIPTION	PIECES/CARTON
PSC-060-Y-CTN	Square corner/yellow	4
PSP-050-Y-CTN	Square panel/yellow	4
PSC-060-B-CTN	Square corner/black	4
PSP-050-B-CTN	Square panel/black	4
PSR-045-Y-CTN	Round/yellow	3
PSR-045-B-CTN	Round/black	3
PSS-2500-BR-SL	Strap 100" black w/locking buckle	2
PSS-4000-BR-SL	Strap 158" black w/locking buckle	2
PSS-4000-YR-SL	Strap 158" yellow w/locking buckle	2
PSWC-FL-BL-1400	Wall Clip - flat black 55.5"	2

NOTE: An increase in raw material costs may increase catalog prices.

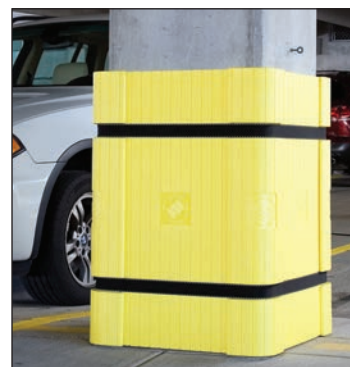

Rack Sentry®

- All Rack Sentry products are 18" tall
- Products are sized to match the width of the rack upright
- All are installed with 2 nylon belts with hook-n-loop fasteners

CAT. NO.	DESCRIPTION (W X D)	LBS.
RS75	3" x 3"	2.6
RS75CO	3" x 3" w/cutout	2.6
RS75END	3" for end of rack	2.6
RS80	3¼" x 3"	2.6
RS90	3½" x 3"	3.0
RS100	4" x 3"	3.0
RS100CO	4" x 3" w/cutout	3.0
RS120	4¾" x 3"	3.25



SHIPPING INFORMATION: 1-2 Weeks, F.O.B. Brook Park, OH

NOTE: An increase in raw material costs may increase catalog prices.



The inventor of impact-resistant equipment for industrial buildings. All Sentry products are highly

visible, incredibly easy to install and highly resistant to impacts. Reduce or eliminate expenses from vehicle collisions with Sentry's protective products.

Column Sentry®

The original, patented column protector, Column Sentry surrounds building columns with a heavy-duty layer of protection against forklift damage. Available in 15 sizes including two sizes that accommodate fire extinguishers. All sizes 42" tall. Installs easily using two nylon straps with hook-n-loop fasteners. No tools needed. Features Sentry's exclusive patented air-vent system that allows air to escape during impact without splitting the sides.

CAT. NO.	DESCRIPTION	TYPE*	LBS.
CS1442-4S	14" o.d. x 42"h w/4" x 4" i.d.	S	30
CS1442-6S	14" o.d. x 42"h w/6" x 6" i.d.	S	30
CS2442-6S	24" o.d. x 42"h w/6" x 6" i.d.	S	56
CS2442-8S	24" o.d. x 42"h w/8" x 8" i.d.	S	56
CS2442-8X10H	24" o.d. x 42"h w/8" x 10" H	H	56
CS2442-9R	24" o.d. x 42"h w/9" dia. i.d.	R	56
CS2442-10S	24" o.d. x 42"h w/10" x 10" i.d.	S	56
CS2442-10X10H	24" o.d. x 42"h w/10" X 10"H	H	56
CS2442-12S	24" o.d. x 42"h w/12" x 12" i.d.	S	56
CS3342-14S	33" o.d. x 42"h w/14" x 14" i.d.	S	75
CS3342-16S	33" o.d. x 42"h w/16" x 16" i.d.	S	75
CS3842-18S	38" o.d. x 42"h w/18" x 18" i.d.	S	90
CS3842-20S	38" o.d. x 42"h w/20" x 20" i.d.	S	90
CS3842-12X24S	38" o.d. x 42"h w/12" x 24" i.d.	S	90
CS4442-30R	44" o.d. x 42"h w/30" dia. i.d.	R	99



*Types:
R - Round
S - Square
H - H Beam or I Beam
FE - Fire Extinguisher Cutout



COLUMN SENTRY® SIZES AND SPECIFICATIONS

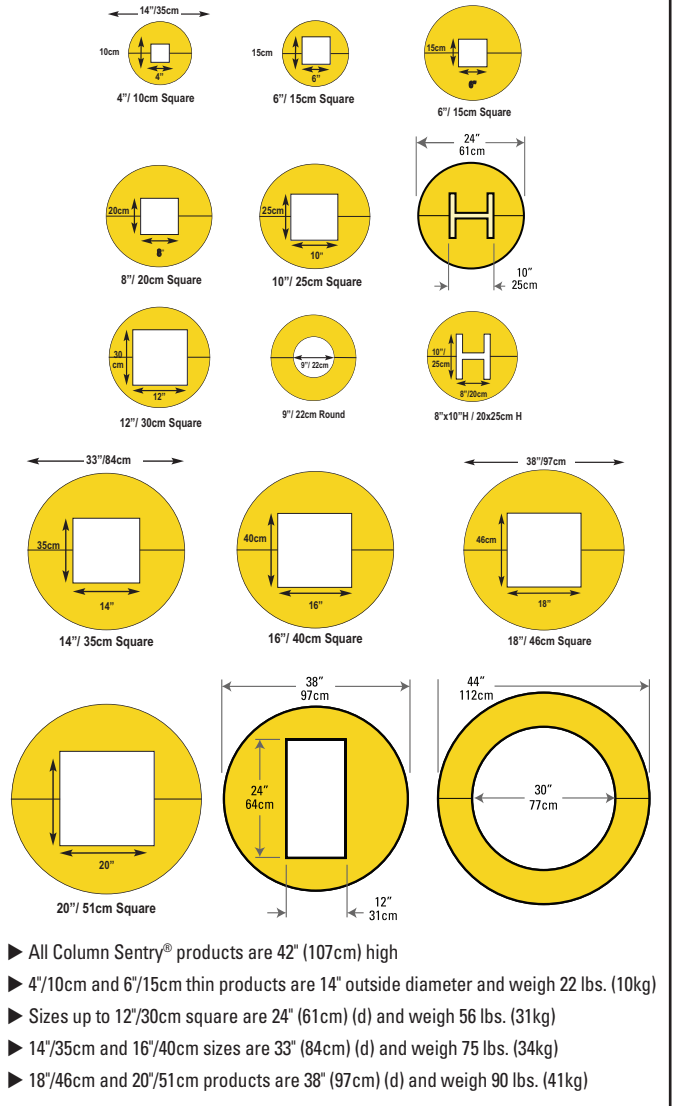

Bollard Covers

- Durable, flexible HDPE plastic designed to absorb impact
- Protects both vehicles and structures from expensive damage
- Two recessed 3M reflective stripes increase visibility and safety
- All colors are available with or without taped stripes

CAT. NO.	SIZE	DESCRIPTION
CL1385D	4.5" x 52"	Yellow/Red Tape
CL1385DD	4.5" x 52"	Yellow/No Tape
CL1385P	4.5" x 52"	Yellow/White Tape
CL1386-A	7" x 60"	Yellow/Red Tape
CL1386AA	7" x 60"	Yellow/No Tape
CL1386B	7" x 60"	Yellow/White Tape
3501R	8 7/8" x 72"	Yellow/Red Tape
3501N	8 7/8" x 72"	Yellow/No Tape
3519W	8 7/8" x 72"	Yellow/White Tape

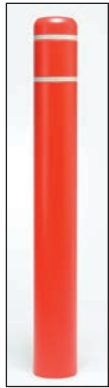

Red with White Tape

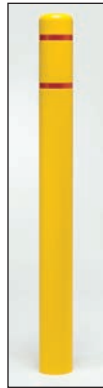

Yellow with Red Tape



Yellow without Tape

Bollard Colors:



Other colors & options available; please contact Crown.

SHIPPING INFORMATION: 3-5 Days, F.O.B. Winfield, KS

Height Guard

- Strong and impact resistant
- Fade resistant
- Closed on both ends
- Includes eye hooks & free graphics kit for customized message
- Ships in two pieces to reduce freight costs

CAT. NO.	SIZE	DESCRIPTION
HTGRD4580	4.5" x 80"	Yellow/Red Tape
HTGRD780	7" x 80"	Yellow/Red Tape

**Other colors available

**SHIPPING INFORMATION:
3-5 Days, F.O.B. Toledo, OH**



POST GUARD®
Maintenance-Free Bollard Protection

What Size Post Guard Do I Need?

If your diameter measures	Then order the
4.5" or less	4.5" POST GUARD
Greater than 4.5 but less than 7"	7" POST GUARD
Greater than 7" but less than 8-7/8"	8-7/8" POST GUARD
Greater than 8-7/8" but less than 10-7/8"	10-7/8" POST GUARD
Greater than 10-7/8" but less than 12-3/4"	12-3/4" POST GUARD



Bollard Covers

- Bollard covers are manufactured using a 1/8" thick High Density Polyethylene (HDPE) with stronger intermolecular forces, tensile strength and solvent resistance
- Contains ultraviolet additives that resist fading and it withstands extreme temperatures
- Guaranteed to be fade resistant for 6 years - longest in the industry
- Quick, easy installation and secure fit



Height Guard

- High Density Polyethylene (HDPE)
- Designed for all weather conditions
- Easily adapts for quick installation
 - 4.5" Dia. x 80"
 - 7" Dia. x 80"



RamGuard™ Column Protection

- Molded of energy-absorbing rubber with a "U-shaped" steel insert and force-distributing rubber voids
- Protects rack structure from frontal, angled and side impacts
- Significantly lowers impact damage to pallet rack columns
- Requires no hardware or straps to retain the guard on column
- Endures many impacts with no loss of performance

SHIPPING INFORMATION:
Call for Availability
F.O.B. North East, P

D. RamGuard™ Column Protection

- Available in 12" heights; snaps onto roll-formed or structural steel columns, 3" wide and up to 3" deep

CAT. NO.	DESCRIPTION	QTY.
572185	RamGuard 5" Column Protection	8-48*
		56-376*
		376+*
556811	RamGuard 12" Column Protection	4-24**
		28-188**
		188+**
700561	RamGuard Velcro Strap (each)	1

*Must order in multiples of eight (8); **Must order in multiples of four (4)



Rubber Shim Kit (Cat. No. 558289): 2 rubber shim pcs/kit; used for 3 x 1½ Roll-Form and 3" Structural Columns.

Rubber Shim Kit (Cat. No. 558290): 2 rubber shim pcs/kit; used for 3 x 2¼ Roll-Form Columns.

E. Column Guards

- Price includes (3) ½" wedge anchors, painted safety yellow

CAT. NO.	LENGTH	LBS.
CG-G-S-3-12-00.0-00085-03.68-0	12"	11
CG-G-S-3-18-00.0-00085-03.68-0	18"	15



Rack Armour Rack Protection

- Proven to reduce racking damage by 80%
- Conforms to European standards for racking protection
- HDPE shell deflects impacts while inner foam absorbs and diffuses energy
- Cylindrical shape protects from all angles and keeps FLT forks in line
- No installation cost
- Slides up for inspection
- Sold worldwide

RA-3A-24-Y



RA-3B-24-Y



C.

C. Rack Armour Rack Protectors — Yellow

- A size is for 1¾" deep rollformed and 3" structural and is 24" H
- B size is for 3" wide x 3" deep rollformed and Mecalux and Ridg-U-Rak w/outer returns 24" H
- C size is for 4" wide x 3" deep teardrop and structural rack and is 24" H
- All models are resistant to most solvents and chemicals and are good to -40°

CAT. NO.	DESCRIPTION	CARTON QTY.
RA-3A-24-Y	A Size 24" Tall	24
RA-3B-24-Y	B Size 24" Tall	18
RA-4C-24-Y	C Size 24" Tall	16

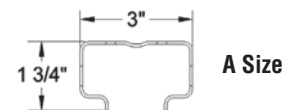

A Size

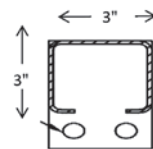

B Size

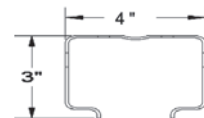

C Size

SHIPPING INFORMATION:
1-2 Weeks,
F.O.B. Corry, PA

SAFETY

A. Stand Guard Ribbed Rails

All-welded lift-out design standard

CAT. NO.	LENGTH	LBS.
RRIB-2-C	2'	23
RRIB-3-C	3'	27
RRIB-4-C	4'	33
RRIB-5-C	5'	40
RRIB-6-C	6'	46
RRIB-7-C	7'	53
RRIB-8-C	8'	59
RRIB-9-C	9'	66
RRIB-10-C	10'	69

B. Columns

CAT. NO.	DESCRIPTION	HEIGHT	LBS.
4RPE-18	End Post	18"	35
4RPC-18	Corner Post	18"	35
4RPIN-18	Inline Post	18"	35
4RPE-42	End Post	42"	59
4RPC-42	Corner Post	42"	59
4RPIN-42	Inline Post	42"	59
4RPE-42-Offset	Offset End Post	42"	49

C. Economy Outrigger Post Protector

CAT. NO.	DESCRIPTION
PP-5BONB-3/8"	Economy Outrigger, no base, mount to frame*

*Eliminates need to drill into concrete; hardware extra.

D. 4" Tall Outrigger Post Protectors

CAT. NO.	DESCRIPTION
PP-4-OR-14	"V" Face, 3.25 Clear, 1/4" Material
PP-4-OR-38	"V" Face, 3.25 Clear, 3/8" Material

E. Post Protectors

Prevent rack damage, costly repairs and frame replacement.

CAT. NO.	DESCRIPTION	MATERIAL THICKNESS	LBS.
PP-12V	12" V-Face 4 1/4" clear opening	3/16"	9
PP-18V	18" V-Face 4 1/4" clear opening	3/16"	13
PP-24V	24" V-Face 4 1/4" clear opening	3/16"	17
PP-12V-1/4"	12" V-Face	1/4"	9
PP-24V-1/4"	24" V-Face	1/4"	17

F. Side Mount

CAT. NO.	HEIGHT
PP-12V-SM	12"
PP-24V-SM	24"

G. Seismic Post Protectors

CAT. NO.	HEIGHT
PP-12V-55	12"
PP-18V-5.5	18"
PP-24B-5.5	24"
PP-12V-8.25	12"
PP-24V-8.25	24"

SHIPPING INFORMATION: All Items in Stock and Ship within 24 Hours; F.O.B. St. Charles, IL

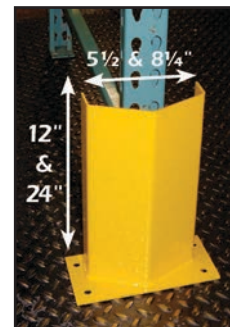
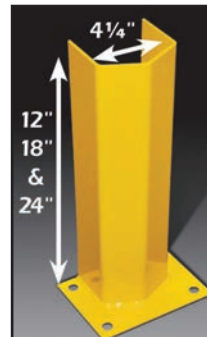
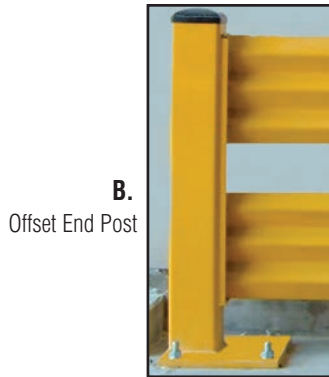
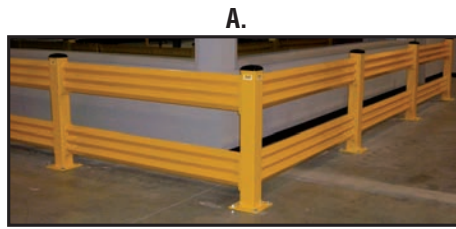

"Save"ty Yellow Products
FACILITY ASSET PROTECTION

Stand Guard Ribbed Rails

- Sleeves are welded to posts; no costly brackets
- Rail fits both 4" and 5" posts with 10" x 10" base plate
- 3 post heights available: 18", 26" and 42" with powder-coated steel caps
- Rails are 2' through 10'
- 5/8" x 4.75" anchors in-stock and available upon request
- Custom lengths available; Contact Savety Yellow for quote

V-Shaped Bolt Down Post Protector

- 4 mounting holes
- Powder-coated safety yellow
- 1/2" x 3.75" anchors available upon request

Side Mount

- The 3.25" clear Side Mount attaches directly to the rack upright.
- There is no base plate. They are available in 12" and 24" high.
- Mounting hardware is not included, but is available in stock.

Seismic Post Protectors

- The Seismic post protectors are the same as the regular V-face, but with 5.5" or 8.25" clearance to accommodate rack with seismic base plates.
- The 5.5" comes 12", 18", and 24" high, while the 8.25" is 12" high.

WorldPro™ Pallet Rack Protection



VGuard



ColumnGuard



WorldGuard



AisleGuard

WorldPro™ protection solutions are designed to fit all types of pallet rack applications protecting the bottom of the upright where most damage occurs. All-welded construction and high-quality, powder coat safety yellow finish will increase awareness and prevent damage to your pallet rack investment.

Size	Part #	Weight (lbs.)	Style
VGuard & VGuard Pro			
4"	NDPV0403125Y	5.8	Outrigger deflector - VGuard
4" Pro	NDPVP403125Y	14.1	Outrigger deflector – VGuard Pro
ColumnGuard and WorldGuard			
12"	NDPP1204000Y	10.9	Traditional Bolt to Floor Design
18"	NDPP1804000Y	14.3	Traditional Bolt to Floor Design
24"	NDPP2404000Y	17.9	Traditional Bolt to Floor Design
24"	NDPW2403000Y	10.5	WorldGuard – bolt-on and bolt to floor
AisleGuard			
42"	NDEA12LC42630Y	66.1	Left Round End
42"	NDEA12RC42630Y	66.1	Right Round End
42"	NDEA12DC42630Y	84.0	Double Round End
48"	NDEA12LC48630Y	72.7	Left Round End
48"	NDEA12RC48630Y	72.7	Right Round End
48"	NDEA12DC48630Y	90.6	Double Round End

Custom sizes and designs available

WorldRail™ Industrial Safety Guard Rail



Preinstalled stainless steel threaded inserts for fast installation



Optional lift out cuff (sold separately)

- 4-3/4" x 4-3/4" x 3/16" thick post
- 4-way designed post, punched on all sides for maximum versatility
- 10" x 10" x 1/2" thick footplate
- Posts available in 42" or 18" heights
- Rail lengths from 2' thru 10' on post centers in 12" increments

Size	Part #	Weight (lbs.)	Style
Guard Rail Posts			
18"	NDGRP185545S1150000Y	31.0	Guard Rail - Post
42"	NDGRP425545S1150000Y	52.6	Guard Rail - Post
Guard Rails (includes 4 bolts per rail)			
24"	NDGRR024A0192800000Y	18.7	Guard Rail - Rail
36"	NDGRR036A0312800000Y	26.4	Guard Rail - Rail
48"	NDGRR048A0432800000Y	34.0	Guard Rail - Rail
60"	NDGRR060A0552800000Y	41.7	Guard Rail - Rail
72"	NDGRR072A0672800000Y	49.3	Guard Rail - Rail
84"	NDGRR084A0792800000Y	57.0	Guard Rail - Rail
96"	NDGRR096A0912800000Y	64.7	Guard Rail - Rail
108"	NDGRR108A1032800000Y	72.3	Guard Rail - Rail
120"	NDGRR120A1152800000Y	80.4	Guard Rail - Rail

SHIPPING INFORMATION: 2 Days, F.O.B.
Chicago, IL; Charlotte, ND; Dallas, TX; Los Angeles, CA;
Seattle, WA; Allentown, PA

Saf-T-Rail Systems

Reduce machinery downtime, inventory loss, and work-related injuries. Heavy-duty columns and rails form protective barriers for in-plant work areas, office walls, doorways, building passages and driveways. All steel construction. 10,000 lb. load at 4 MPH rating. All anchors and hardware included.

Safety Products

Correcting the effects of plant accidents on people and equipment after they've happened is extremely expensive and time consuming. Now you can reduce these and lower the associated costs of downtime, lost inventories, workers' compensation claims and building repairs.

Saf-T-Header

Protects overhead mechanical lines and conveyors. Protects automatic overhead doors and reduces costly repairs in plants, warehouses, shipping areas, etc. "Banger Bar" warns operator. Quick, easy installation. Adjusts to fit width/height required. Bright OSHA yellow finish.

Saf-T-Gard

Keep your personnel and visitors safe and out of the way from high traffic and dangerous areas.

- An economical and versatile handrail system for plants, warehouses, etc.
- Quick, easy installation
- Lightweight and reusable
- OSHA two-rail and BOCA three-rail compliant
- Polished aluminum fittings

A. Protective Guard Rails*

CAT. NO.	LENGTH	LBS.
R10	10'	84
R9	9'	75
R8	8'	67
R7	7'	59
R6	6'	51
R5	5'	43
R4	4'	35
R3	3'	27

*Lift-Out rails available. Call for pricing.

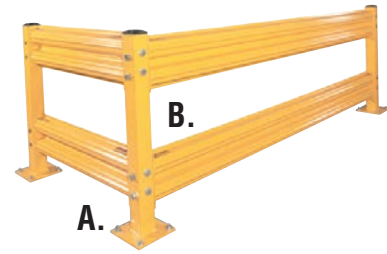

B. Protective Columns

Columns are 4" square. Base plates are 10" square.

CAT. NO.	HEIGHT	LBS.
C1	18" (single rail)	31
C2	42" (dual rail)	51
C3	42" (triple rail)	52



C. Bollards

CAT. NO.	DESCRIPTION	LBS.
B4SD	4" Dia. x 40" Tall Std. Duty (sch10)	24
B4HD	4" Dia. x 40" Tall Heavy Duty (sch40)	42
B6SD	6" Dia. x 40" Tall Std. Duty (sch10)	49
B6HD	6" Dia. x 40" Tall Heavy Duty (sch40)	81

D. Trak Armor (per set)

- Protects vulnerable and costly door track.
- Deflects blows away from door track.
- Manufactured from 1/4" steel.
- Floor anchors included; wall anchors not included.

CAT. NO.	HEIGHT	LBS.
TA24HD	24"	60
TA36HD	36"	84
TA48HD	48"	116

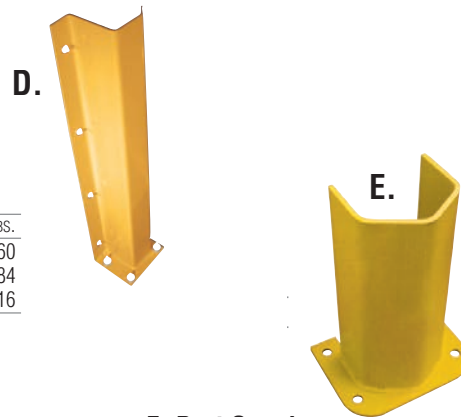

E. Post Guards

- Requires 1/2" wedge anchors (not provided).
- Heavy-duty 1/4" steel upright welded to 3/8" base.

CAT. NO.	HEIGHT	LBS.
P12HD	12"	12
P18HD	18"	17
P24HD	24"	21
P36HD	36"	31

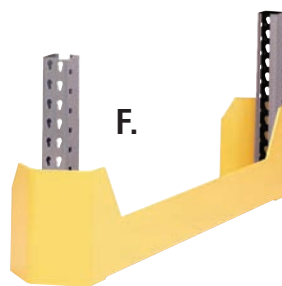

F. Rack Guards

- Anchors included

CAT. NO.	DESCRIPTION	LBS.
RG42	42" Deep	50
RG48	48" Deep	60
RG42(L/R)*	42" Deep	45
RG48(L/R)*	48" Deep	45

*For use with back to back racks. Please specify if the channel guard should be on the left or right side.

SHIPPING INFORMATION:
1-2 Weeks, F.O.B. Harrison, OH & Lodi, CA

WILGARD XT



Wilgard® XT Heavy-Duty Rack Protection

Half-Moon Head: 12" H x ½" thick
Angle: 4" W x 6" H x ½" thick

CAT. NO.	DESCRIPTION	LBS. W/ANCHORS
WRPXT26-ROS	26" Right Side Rack Protector	61
WRPXT26-LOS	26" Left Side Rack Protector	61
WRPXT36-ROS	36" Right Side Rack Protector	74
WRPXT36-LOS	36" Left Side Rack Protector	74
WRPXT42-ROS	42" Right Side Rack Protector	83
WRPXT42-LOS	42" Left Side Rack Protector	83
WRPXT48-ROS	48" Right Side Rack Protector	94
WRPXT48-LOS	48" Left Side Rack Protector	94
WRPXT60-ROS	60" Right Side Rack Protector*	113
WRPXT60-LOS	60" Left Side Rack Protector*	113
WRPXT72-ROS	72" Right Side Rack Protector*	133
WRPXT72-LOS	72" Left Side Rack Protector*	133
WRPXT48-EXY	48" Extension Angle	67

*Custom

WILGARD MT



Wilgard® MT Medium-Duty Rack Protection

Half-Moon Head: 8" H x ⅝" thick
Angle: 3½" W x 6" H x ⅝" thick

CAT. NO.	DESCRIPTION	LBS. W/ANCHORS
WRPMT42-ROS	42" Right Side Rack Protector	55
WRPMT42-LOS	42" Left Side Rack Protector	55
WRPMT48-ROS	48" Right Side Rack Protector	61
WRPMT48-LOS	48" Left Side Rack Protector	61
WRPMT48-EXY	48" Extension Angle	40

WILGARD LT



Wilgard® LT Light-Duty Rack Protection

Special Formed Head: 8" H x ¼" thick
Angle: 3" W x 5" H x ¼" thick

CAT. NO.	DESCRIPTION	LBS. W/ANCHORS
WRPLT42-ROS	42" Right Side Rack Protector	30
WRPLT42-LOS	42" Left Side Rack Protector	30
WRPLT48-ROS	48" Right Side Rack Protector	35
WRPLT48-LOS	48" Left Side Rack Protector	35
WRPLT48-EXY	48" Extension Angle	27



SHIPPING INFORMATION: 2 Days, F.O.B. Waukesha, WI

WILGARD XT



Wilgard® XT Guard Rail

Impact Rating: 13,000 lbs. at 4 mph
Columns: 5" x 5" x ⅜" structural tube
Base Plates: 12" x 12" x ¼" plate steel
Rails: 12" high, 11-gauge steel

CAT. NO.	DESCRIPTION	LBS.
WG10	10' Guard Rail	71
WG9	9' Guard Rail	65
WG8	8' Guard Rail	58
WG7	7' Guard Rail	52
WG6	6' Guard Rail	45
WG5	5' Guard Rail	39
WG4	4' Guard Rail	32
WG3	3' Guard Rail	26
WG2	2' Guard Rail	19
XT Columns		
WC18	18" Single Rail	50
WC44	44" Double Rail	75
WCT44	44" Triple Rail	75

WILGARD MT



Wilgard® MT Guard Rail

Impact Rating: 10,000 lbs. at 4 mph (industry standard)
Columns: 4" x 4" x ⅜" structural tube
Base Plates: 10" x 10" x ⅝" plate steel
Rails: 12" high, 12-gauge steel

CAT. NO.	DESCRIPTION	LBS.
WM10	10' Guard Rail	67
WM9	9' Guard Rail	61
WM8	8' Guard Rail	55
WM7	7' Guard Rail	49
WM6	6' Guard Rail	43
WM5	5' Guard Rail	37
WM4	4' Guard Rail	31
WM3	3' Guard Rail	25
WM2	2' Guard Rail	18
MT Columns		
WCM18	18" Single Rail	33
WCM44	44" Double Rail	52
WCMT44	44" Triple Rail	52

WILGARD LT



Wilgard® LT Guard Rail

Impact Rating: Light Duty
Columns: 3½" x 3½" x ⅜" structural tube
Base Plates: 7" x 7" x ⅝" plate steel
Rails: 12" high, 14-gauge steel

CAT. NO.	DESCRIPTION	LBS.
WL10	10' Guard Rail	50
WL9	9' Guard Rail	45
WL8	8' Guard Rail	41
WL7	7' Guard Rail	37
WL6	6' Guard Rail	32
WL5	5' Guard Rail	28
WL4	4' Guard Rail	23
WL3	3' Guard Rail	19
WL2	2' Guard Rail	15
LT Columns		
WCL18	18" Single Rail	18
WCL44	44" Double Rail	36
WCLT44	44" Triple Rail	36

Note: Required hardware is included in XT, MT and LT guard rail and rack protector.

SHIPPING INFORMATION: 2 Days, F.O.B. Waukesha, WI

Row End Guards

- ½" structural steel construction
- AWS-certified welding
- ¾" diameter anchors
- Durable finish
- Custom colors and lengths available

Jumbo Truss

- Built-in protection at ends of rows and tunnels
- Maximize your aisle width
- Compatible with your existing structural rack
- 1" anchors
- Durable finish; custom colors available

Protect Your Investment

RBI heavy-duty rack protection adds structural steel integrity to your new or existing rack installation.

Row End Guards - Single

CAT. NO.	LENGTH	RIGHT OR LEFT	ANCHORS NEEDED	LBS.
SR-24	24"	Right	2	62
SL-24	24"	Left	2	62
SR-36	36"	Right	3	78
SL-36	36"	Left	3	78
SR-42	42"	Right	3	86
SL-42	42"	Left	3	86
SR-48	48"	Right	3	94
SL-48	48"	Left	3	94
SR-50	50"	Right	3	97
SL-50	50"	Left	3	97

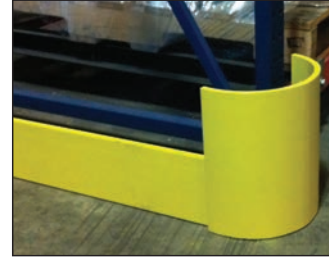

Row End Guards - Double

CAT. NO.	LENGTH	ANCHORS NEEDED	LBS.
DB-24	24"	2	91
DB-36	36"	3	107
DB-42	42"	3	115
DB-48	48"	3	123
DB-60	60"	4	140
DB-72	72"	4	156
DB-84	84"	4	172
DB-96	96"	5	188
DB-102	102"	5	196
DB-108	108"	5	204

Note: ¾" diameter anchors available separately.



SHIPPING INFORMATION: 4-6 Weeks, F.O.B. Quincy, IL

Machine Guards

Specifications:

Steel Tube — 5 x 5" x ¾"

Base Plate — 9" x 9" x ¾"

Heights — 10", 24" and 42"

CAT. NO.	DESCRIPTION
WG-1036	10" H x 36" W
WG-1048	10" H x 48" W
WG-2436	24" H x 36" W
WG-2448	24" H x 48" W
WG-4236	42" H x 36" W
WG-4248	42" H x 48" W



SHIPPING INFORMATION:
5-7 Business Days,
F.O.B. Waukesha, WI



Machine Guards

Safeguard expensive machinery and employees from lift truck impacts with high-visible machine guards. Built to last, these safety guards are made from tubular steel.

Assembled as a complete "U" shaped unit, Wildeck machine guards can be bolted to the surface or secured in concrete for maximum safety.

Features:

- Solid, quality construction
- Easy, fast installation
- Functional, reliable design
- Painted safety yellow



DSTACKER^{GS}

GRAVITY SERIES
ZERO POWER REQUIRED!



The world's only **Pallet Dispenser with DC Control System** for order filling applications that is improving the warehouse...one pallet at a time.

QTEK Design is the first to introduce a series of Pallet Dispensing options that streamlines your processes, improves performance, reduces your pallet storage footprint, and aids in the reduction of work-related injuries from handling pallets.

- 100 %** reduction in pallet handling injuries
- Strong ROI of less than twelve months**
- 50 %** reduction in pallet dispensing standard time

Key Features:

- Designed for wood/plastic four-way-entry pallets, half-pallets, and/or nestable pallets.
- 30,40, 50, and up to 150 pallets capacity configurations
- Touchless operation with minimum maintenance cost.

- Safety
- Pallet Quality
- Productivity
- Reduces Pallet Store Space
- Moral
- Flexible Lease Terms

- Maximizes premium real state utilization
- Minimize Order Picker fatigue
- Increase morale and productivity
- Zero AC Power models.



High Density Pallet Storage

PALLET TOWER



Store up to 80 48"x40" pallets in a 5'x 5' footprint.

The Pallet Tower is loaded and unloaded from the bottom by a forklift. 4 seconds per pallet.

Maximize floor space, minimize forklift operator travel time and eliminate wasting time manipulating pallets.

Strong ROI. Any type of 48x40 pallet. Call for custom.

Increase safety, eliminate risk of pallets breaking or becoming unstable, therefore leading to severe injuries and product damage.

- Benefits
- Safety
 - Revenue
 - Forklift
 - 5S Housekeeping
 - Maximize Floor Space
 - Flexible Lease Terms

Improving the Warehouse...one pallet at a time.



Pallet Splitting / Layer Picking
THE BOMBER



No Product Damage

Low Level Pallet Exchange
PALLET X



No Inverting

Pallet Dispensing
DSTACKER^{GS}



No More Manual Pallet Handling

High Density Pallet Storage
PALLET TOWER



Free Up Floor Space

SAFETY



READY FOR IMPACT



BOPLAN has been a leader in safety ever since it introduced flexible guardrails to the industrial market. Our polymer products “flex” upon impact, absorbing up to 80% of impact energy, and immediately returns to its original shape, highly reducing the damages typically associated with traditionally barrier products.

- Extremely strong, offering optimal safety
- Flexible material, doesn't get damaged
- After impact, guard rails return to original shape
- Drastically reduce repairs to guard rails and concrete floors!
- Long product life, easy to install

Flex Impact®

Our Flex Impact® brand stands for the very best flexible safety products available on the market today including:

Handrails: Our flexible handrails are just great to use when you want to separate pedestrians from traffic by creating a physical barrier in a light or parallel traffic area. They will absorb a slight impact but are not meant to stop heavy impacts. Our handrails are modular and extremely easy to install.

Guardrails: Our flexible guardrails are the best solution on the market today to protect your people, machines or infrastructure from impacts by forklift trucks. We have a vast offer of guardrails that meet your needs based on both height and strength requirements.

Gates: We have a full range of swinging, sliding and lift gates ranging from 3' to 6' to meet all your requirements.

Kick Plates: Our PL Hexa kick plates are made from heavy duty polymer to be mounted directly onto the floor, typically used as an alternative to angle iron, and can be used as a barrier or stop for low speed impacts.

Rack Protection: Our RackBull snaps on uprights in 3 seconds and offers market leading protection to your uprights, while our Rack Protectors are guardrails that are specifically made to protect your rack “ends”.

Column Protection: BOPLAN has a full range of high quality corner and column protections which have been designed with a purposely smooth finish so that forks or lifts cannot grab onto them. These column protectors have an award winning design and are made from heavy duty polymer to give them the needed elasticity to protect your columns.

Flex Impact® Flip

Our FLIP range of kickrails offers full ground level protection and is available in different strengths and versions depending on the needs. The innovative and robust I-shaped rail absorbs impacts of 3.000 Joules (Flip 120) up to 16.000 Joules (Flip 200 Force). FLIP is quick and easy to install and can be combined with other Boplan traffic barrier systems for maximum safety. Our latest product FLIPTM, available in different lengths, covers all angles thanks to its flexible and modular design with connection pieces.



Reference List Flex Impact® Flip

Size (inch)	FLIP 120 (YELLOW/Black)	FLIP 120 (BLACK/Yellow)	FLIP 180 (YELLOW/Black)	FLIP 180 (BLACK/Yellow)	FLIP 200 (YELLOW/Black)	FLIP 200 (BLACK/Yellow)
24 (2fix)	PL1210-0610-0001YB	PL1210-0610-0001BY	PL1810-0610-0001YB	PL1810-0610-0001BY	PL2020-0500-0001YB	PL2020-0500-0001BY
36 (2fix)	PL1210-0915-0001YB	PL1210-0915-0001BY	PL1810-0915-0001YB	PL1810-0915-0001BY	PL2020-1000-0001YB	PL2020-1000-0001BY
48 (2fix)	PL1210-1220-0001YB	PL1210-1220-0001BY	PL1810-1220-0001YB	PL1810-1220-0001BY	PL2020-2000-0001YB	PL2020-2000-0001BY
60 (3fix)	PL1210-1525-0001YB	PL1210-1525-0001BY	PL1810-1525-0001YB	PL1810-1525-0001BY	PL2020-3000-0001YB	PL2020-3000-0001BY
72 (3fix) 25-51 (2fix) FLIP 200	PL1211-1828-0001YB	PL1211-1828-0001BY	PL1810-1828-0001YB	PL1810-1828-0001BY	PL2021-1300-0001YB	PL2021-1300-0001BY
78 (3fix) 52-86 (3fix) FLIP 200	PL1211-1980-0001YB	PL1211-1980-0001BY	PL1810-1980-0001YB	PL1811-1980-0001BY	PL2021-2200-0001YB	PL2021-2200-0001BY
120 (4fix) 87-118 (4fix) FLIP 200	PL1211-3048-0001YB	PL1211-3048-0001BY	PL1810-3048-0001YB	PL1811-3048-0001BY	PL2021-2999-0001YB	PL2021-2999-0001BY

SAFETY

Flex Impact® TB400 Polymer Guardrail

The Flex Impact® TB400 is the original polymer traffic barrier. At 16" high, it has been conceived to protect machinery and infrastructure from accidental forklift impacts.



Order Ref	Description	Includes	Weight
TB41060S	TB400 5'10" Starter Set	2 x End Post + 1 Tube	84 lbs
TB41060E	TB400 5' Extension Set	1 x Mid Post + 1 Tube	48 lbs
TB41048E	TB400 4' Extension Set	1 x Mid Post + 1 Tube	45 lbs
TB41036E	TB400 3' Extension Set	1 x Mid Post + 1 Tube	42 lbs

TB 400 & 400 Plus will stop light to medium forklift impacts.

You can extend the 5' Starter Set with either 5, 4 or 3 ft Extension Sets to create the desired length.

Flex Impact® TB400 Plus Polymer Guardrail

The Flex Impact® TB400 Plus is our bestselling polymer traffic barrier and is ideal for creating walkways. At 43" high, it has been conceived to protect people, machinery and infrastructure from accidental forklift impacts.

Order Ref	Description	Includes	Weight
TBP41060S	TB400 Plus 5'10" Starter Set	2 x End Post + 1 Tube + 2 rails	104 lbs
TBP41060E	TB400 Plus 5' Extension Set	1 x Mid Post + 1 Tube + 2 rails	53 lbs
TBP41048E	TB400 Plus 4' Extension Set	1 x Mid Post + 1 Tube + 2 Rails	48 lbs
TBP41036E	TB400 Plus 3' Extension Set	1 x Mid Post + 1 Tube + 2 rails	43 lbs



Flex Impact® HP Plus Handrail

The BOPLAN HP Plus handrails are made from polymer and will absorb light impacts, after which they'll return to their original shape. This means no more paint jobs and highly reduced maintenance and repairs! The HP Plus is 43" high, has three rails and is the perfect system to create walkways and direct pedestrian traffic flow in light-traffic areas. The HP Plus is fully modular. You can extend the 5' Starter Set with either 5, 4 or 3 ft. Extension Sets to create the desired length.



Order Ref	Description	Includes	Weight
HP1060S	HP Plus 5' Starter Set	2 x End Post + 3 Rails	49
HP1060E	HP Plus 5' Extension Set	1 x Mid Post + 3 rails	30
HP1048E	HP Plus 4' Extension Set	1 x Mid Post + 3 rails	28
HP1036E	HP Plus 3' Extension Set	1 x Mid Post + 3 rails	26

Flex Impact® TB400D Double Polymer Guardrail

The Flex Impact® TB400 Double is our heavy-duty polymer traffic barrier. At 30" high, it has been conceived to protect people, machinery and infrastructure from accidental forklift impacts. Made from flexible Polymer, the TB400 Plus will absorb the impact energy and immediately return to its original shape.



TB400 Double will stop medium to heavy forklift impacts.

You can extend the 5' Starter Set with either 5, 4 or 3 ft Extension Sets to create the desired length.

Order Ref	Description	Includes	Weight
TBD41060S	TB400 Double 5'10" Starter Set	2 x End Post + 2 Tubes	157 lbs
TBD41060E	TB400 Double 5' Extension Set	1 x Mid Post + 2 Tubes	94 lbs
TBD41048E	TB400 Double 4' Extension Set	1 x Mid Post + 2 Tubes	89 lbs
TBD41036E	TB400 Double 3' Extension Set	1 x Mid Post + 2 Tubes	83 lbs

Flex Impact® RackBulls

The Flex Impact® RackBull is the optimal way to protect your pallet rack uprights. The RackBull easily mounts in 3 seconds and snaps around your upright to offer protection against smaller accidental impacts. This highly reduces the cost of install when compared to traditional protection. The RackBull has gained wide acceptance as a market leader because of both the level of protection it offers as well as ease of installation.

The RACKBULL XL fits on all uprights with 3" depth and max 4" width. The RACKBULL L fits on all racks with a 1-5/8" depth. Please call us if you are not sure about the size.

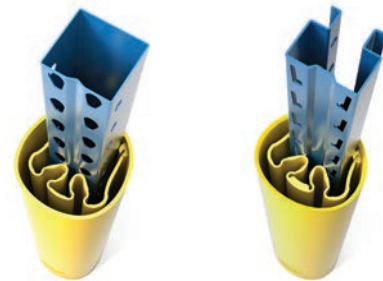

Rack Bull XL for 3" deep uprights

Rack Bull L for 1-5/8" deep uprights

Order Ref	Description	Qty	Height	Weight
RBX-0001	RackBull XL	1	H 24"	4.5 lbs
RBX-0060	RackBull XL	60	H 24"	4.5 lbs
RBX-0600	RackBull XL	600	H 24"	4.5 lbs
RBX-1200	RackBull XL	1200+	H 24"	4.5 lbs
RBL-0001	RackBull L	1	H 24"	3.5 lbs
RBL-0060	RackBull L	60	H 24"	3.5 lbs
RBL-0600	RackBull L	600	H 24"	3.5 lbs
RBL-1200	RackBull L	1200+	H 24"	3.5 lbs

Ergonomic, Anti-Fatigue & Safety Matting

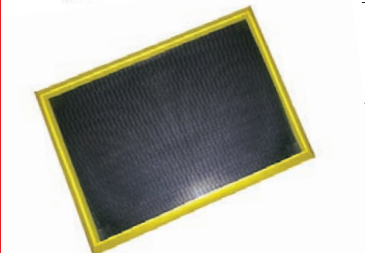
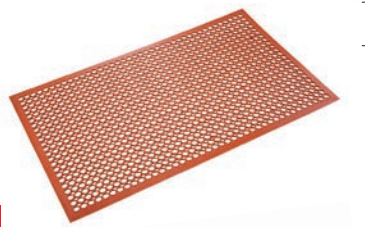

THICKNESS	TYPE	SIZE	ITEM CODE	COLORS	UOM	APPLICATION
-----------	------	------	-----------	--------	-----	-------------

#410 SAFE-N-EASY RIB https://www.crownmats.com/products/tuff-spun-foot-lover						
3/8"	Mats	2' x 3'	SE 3823YB	Black w/Yellow Borders	EA	DRY ENVIRONMENT
		3' x 5'	SE 3835YB			
		3' x 12'	SE 3832YB			
	Rolls	2' x 60'	SER3824YB			
		3' x 60'	SER3836YB			
4' x 60'	SER3848YB					

#500 INDUSTRIAL DECK PLATE https://www.crownmats.com/products/industrial-deck-plate						
9/16"	Mats	2' x 3'	CD 0023xx	DB (Black) DG (Gray) YB (Black w/Yellow Borders)	EA	DRY ENVIRONMENT
		3' x 5'	CD 0035xx			
		3' x 12'	CD 0312xx			
	Rolls	2' x 75'	CDR0024xx-75			
		3' x 75'	CDR0036xx-75			
4' x 75'	CDR0048xx-75					

#505 INDUSTRIAL DECK PLATE https://www.crownmats.com/products/industrial-deck-plate						
7/8"	Mats	2' x 3'	CD 3423xx	DB (Black) DG (Gray) YB (Black w/Yellow Borders)	EA	DRY ENVIRONMENT
		3' x 5'	CD 3435xx			
		3' x 12'	CD 3432xx			
	Rolls	2' x 75'	CDR3424xx-75			
		3' x 75'	CDR3436xx-75			
4' x 75'	CDR3448xx-75					

THICKNESS	TYPE	SIZE	ITEM CODE	COLORS	UOM	APPLICATION
-----------	------	------	-----------	--------	-----	-------------

#645 SAFEWALK-LIGHT GENERAL PURPOSE https://www.crownmats.com/products/safewalk-light						
1/2"	Mats	3' x 5' Bulk (50 pcs)	WS BT35BK	BLACK	SKID EA EA EA EA	OILY ENVIRONMENT
		3' x 5'	WS CT35BK			
		3' x 10'	WS CT31BK			
		3' x 15'	WS CT15BK			
		3' x 20'	WS CT32BK			

#646 SAFEWALK-LIGHT GREASE RESISTANT https://www.crownmats.com/products/safewalk-light						
1/2"	Mats	3' x 5' Bulk (50 pcs)	WS BT35TC	TERRA COTTA	SKID EA EA EA EA	OILY ENVIRONMENT
		3' x 5'	WS CT35TC			
		3' x 10'	WS CT31TC			
		3' x 15'	WS CT15TC			
		3' x 20'	WS CT32TC			

TYPE	SIZE	ITEM CODE	COLORS	UOM	APPLICATION
------	------	-----------	--------	-----	-------------

#102 DISINFECTANT BOOT BATH https://www.crownmats.com/products/disinfectant-boot-bath					
Mats	32" x 39" Bulk (20 pcs)	BD B239YB	BLACK/YELLOW	SKID	STERILE ENVIRONMENTS, HEALTHCARE, ETC.
	32" x 39" Boxed	BD 3239YB		EA	

#820 PRO-TEKT RUNNER https://www.crownmats.com/products/pro-tekt-runner					
Rolls	3' x 60'	PBR1836BK	BLACK	EA	STOCK ROOMS OR STORAGE SPACE, WAREHOUSES, AREAS TO PROTECT FLOORS
	4' x 60'	PBR 1848BK			
	6' x 60'	PBR1872BK			

Ergonomic, Safety & Anti-Fatigue Matting

A. 3/8" Soft Foot

CAT. NO.	DESCRIPTION	THICKNESS	SIZE	UOM
20-160-Color-2X3	3/8" Soft Foot Std	3/8"	2' x 3'	Each
20-160-Color-3X5	3/8" Soft Foot Std	3/8"	3' x 5'	Each
20-160-Color-2X60	3/8" Soft Foot Std	3/8"	2' x 60'	Each
20-160-Color-3X60	3/8" Soft Foot Std	3/8"	3' x 60'	Each
20-160-Color-4X60	3/8" Soft Foot Std	3/8"	4' x 60'	Each
20-160-Color-6X60	3/8" Soft Foot Std	3/8"	6' x 60'	Each

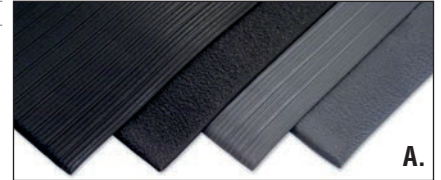

SPECIAL LENGTH CUTS UP TO 60' IN LENGTH

20-160-Color-2'CutsX?	3/8" Soft Foot Std	3/8"	2' Widths up to 60' in Length	Sq. Ft.
20-160-Color-3'CutsX?	3/8" Soft Foot Std	3/8"	3' Widths up to 60' in Length	Sq. Ft.
20-160-Color-4'CutsX?	3/8" Soft Foot Std	3/8"	4' Widths up to 60' in Length	Sq. Ft.
20-160-Color-6'CutsX?	3/8" Soft Foot Std	3/8"	6' Widths up to 60' in Length	Sq. Ft.

B. 3/8" Safety Soft Foot

CAT. NO.	DESCRIPTION	THICKNESS	SIZE	UOM
20-163-0903-2X3	3/8" Safety Soft Foot Pebble	3/8"	2' x 3'	Each
20-163-0903-3X5	3/8" Safety Soft Foot Pebble	3/8"	3' x 5'	Each
20-163-0903-2X60	3/8" Safety Soft Foot Pebble	3/8"	2' x 60'	Each
20-163-0903-3X60	3/8" Safety Soft Foot Pebble	3/8"	3' x 60'	Each
20-163-0903-4X60	3/8" Safety Soft Foot Pebble	3/8"	4' x 60'	Each



SPECIAL LENGTH CUTS UP TO 60' IN LENGTH

20-163-0903-2'CutsX?	3/8" Safety Soft Foot Pebble	3/8"	2' Widths up to 60' in Length	Sq. Ft.
20-163-0903-3'CutsX?	3/8" Safety Soft Foot Pebble	3/8"	3' Widths up to 60' in Length	Sq. Ft.
20-163-0903-4'CutsX?	3/8" Safety Soft Foot Pebble	3/8"	4' Widths up to 60' in Length	Sq. Ft.

C. 1/2" Invigorator

CAT. NO.	DESCRIPTION	THICKNESS	SIZE	UOM
SOLID BLACK				
34-470-0900-2X3	1/2" Invigorator B	1/2"	2' x 3'	Each
34-470-0900-3X5	1/2" Invigorator B	1/2"	3' x 5'	Each
34-470-0900-2X75	1/2" Invigorator B	1/2"	2' x 75'	Each
34-470-0900-3X75	1/2" Invigorator B	1/2"	3' x 75'	Each
34-470-090-4X75	1/2" Invigorator B	1/2"	4' x 75'	Each

SPECIAL LENGTH CUTS UP TO 75' IN LENGTH

34-470-0900-2'CutsX?	1/2" Invigorator BY	1/2"	2' Widths up to 75' in Length	Sq. Ft.
34-470-0900-3'CutsX?	1/2" Invigorator BY	1/2"	3' Widths up to 75' in Length	Sq. Ft.
34-470-0900-4'CutsX?	1/2" Invigorator BY	1/2"	4' Widths up to 75' in Length	Sq. Ft.

YELLOW BORDER

34-470-0903-2X3	1/2" Invigorator YB	1/2"	2' x 3'	Each
34-470-0903-3X5	1/2" Invigorator YB	1/2"	3' x 5'	Each
34-470-0903-2X75	1/2" Invigorator YB	1/2"	2' x 75'	Each
34-470-0903-3X75	1/2" Invigorator YB	1/2"	3' x 75'	Each
34-470-0903-4X75	1/2" Invigorator YB	1/2"	4' x 75'	Each

SPECIAL LENGTH CUTS UP TO 75' IN LENGTH

34-470-0903-2'CutsX?	1/2" Invigorator YB	1/2"	2' Widths up to 75' in Length	Sq. Ft.
34-470-0903-3'CutsX?	1/2" Invigorator YB	1/2"	3' Widths up to 75' in Length	Sq. Ft.
34-470-0903-4'CutsX?	1/2" Invigorator YB	1/2"	4' Widths up to 75' in Length	Sq. Ft.



SHIPPING INFORMATION: F.O.B. Calhoun, GA

SAFETY

Ergonomic, Safety & Anti-Fatigue Matting

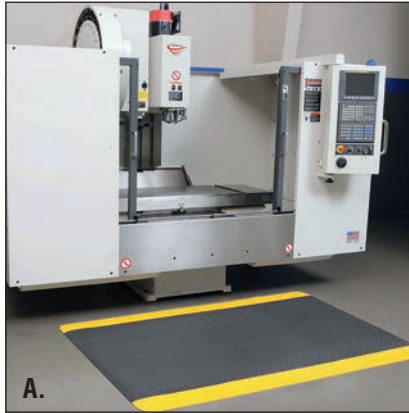

A. 15/16" Ultimate Diamond Foot

CAT. NO.	DESCRIPTION	THICKNESS	SIZE	UOM
ULTIMATE DIAMOND PLATE MATS BLACK/YELLOW				
39-565-0903-2X3	15/16" Ultimate Diamond Foot B/Y	15/16"	2' x 3'	Each
39-565-0903-3X5	15/16" Ultimate Diamond Foot B/Y	15/16"	3' x 5'	Each
39-565-0903-3X10	15/16" Ultimate Diamond Foot B/Y	15/16"	3' x 10'	Each
39-565-0903-2X75	15/16" Ultimate Diamond Foot B/Y	15/16"	2' x 75'	Each
39-565-0903-3X75	15/16" Ultimate Diamond Foot B/Y	15/16"	3' x 75'	Each
39-565-0903-4X75	15/16" Ultimate Diamond Foot B/Y	15/16"	4' x 75'	Each
SPECIAL LENGTH CUTS UP TO 75' IN LENGTH				
39-565-0903-2'CutsX?	15/16" Ultimate Diamond Foot B/Y	15/16"	2' Widths up to 75' in Length	Sq. Ft.
39-565-0903-3'CutsX?	15/16" Ultimate Diamond Foot B/Y	15/16"	3' Widths up to 75' in Length	Sq. Ft.
39-565-0903-4'CutsX?	15/16" Ultimate Diamond Foot B/Y	15/16"	4' Widths up to 75' in Length	Sq. Ft.
ULTIMATE DIAMOND PLATE MATS SOLID BLACK				
39-565-0900-2X3	15/16" Ultimate Diamond Foot Blk	15/16"	2' x 3'	Each
39-565-0900-3X5	15/16" Ultimate Diamond Foot Blk	15/16"	3' x 5'	Each
39-565-0900-3X10	15/16" Ultimate Diamond Foot Blk	15/16"	3' x 10'	Each
39-565-0900-2X75	15/16" Ultimate Diamond Foot Blk	15/16"	2' x 75'	Each
39-565-0900-3X75	15/16" Ultimate Diamond Foot Blk	15/16"	3' x 75'	Each
39-565-0900-4X75	15/16" Ultimate Diamond Foot Blk	15/16"	4' x 75'	Each
SPECIAL LENGTH CUTS UP TO 75' IN LENGTH				
39-565-0900-2'CutsX?	15/16" Ultimate Diamond Foot Blk	15/16"	2' Widths up to 75' in Length	Sq. Ft.
39-565-0900-3'CutsX?	15/16" Ultimate Diamond Foot Blk	15/16"	3' Widths up to 75' in Length	Sq. Ft.
39-565-0900-4'CutsX?	15/16" Ultimate Diamond Foot Blk	15/16"	4' Widths up to 75' in Length	Sq. Ft.



B. 9/16" Diamond Foot

CAT. NO.	DESCRIPTION	THICKNESS	SIZE	UOM
DIAMOND PLATE MATS BLACK/YELLOW				
39-065-0903-2X3	9/16" Diamond Foot B/Y	9/16"	2' x 3'	Each
39-065-0903-3X5	9/16" Diamond Foot B/Y	9/16"	3' x 5'	Each
39-065-0903-3X10	9/16" Diamond Foot B/Y	9/16"	3' x 10'	Each
39-065-0903-2X75	9/16" Diamond Foot B/Y	9/16"	2' x 75'	Each
39-065-0903-3X75	9/16" Diamond Foot B/Y	9/16"	3' x 75'	Each
39-065-0903-4X75	9/16" Diamond Foot B/Y	9/16"	4' x 75'	Each
SPECIAL LENGTH CUTS UP TO 75' IN LENGTH				
39-065-0903-2'CutsX?	9/16" Diamond Foot B/Y	9/16"	2' Widths up to 75' in Length	Sq. Ft.
39-065-0903-3'CutsX?	9/16" Diamond Foot B/Y	9/16"	3' Widths up to 75' in Length	Sq. Ft.
39-065-0903-4'CutsX?	9/16" Diamond Foot B/Y	9/16"	4' Widths up to 75' in Length	Sq. Ft.
DIAMOND PLATE MATS SOLID BLACK				
39-065-0900-2X3	9/16" Diamond Foot Blk	9/16"	2' x 3'	Each
39-065-0900-3X5	9/16" Diamond Foot Blk	9/16"	3' x 5'	Each
39-065-0900-3X10	9/16" Diamond Foot Blk	9/16"	3' x 10'	Each
39-065-0900-2X75	9/16" Diamond Foot Blk	9/16"	2' x 75'	Each
39-065-0900-3X75	9/16" Diamond Foot Blk	9/16"	3' x 75'	Each
39-065-0900-4X75	9/16" Diamond Foot Blk	9/16"	4' x 75'	Each
SPECIAL LENGTH CUTS UP TO 75' IN LENGTH				
39-065-0900-2'CutsX?	9/16" Diamond Foot Blk	9/16"	2' Widths up to 75' in Length	Sq. Ft.
39-065-0900-3'CutsX?	9/16" Diamond Foot Blk	9/16"	3' Widths up to 75' in Length	Sq. Ft.
39-065-0900-4'CutsX?	9/16" Diamond Foot Blk	9/16"	4' Widths up to 75' in Length	Sq. Ft.



C. Knee Saver

CAT. NO.	DESCRIPTION	THICKNESS	SIZE	UOM
39-098-0900-01400021	KneeSaver	1"	14" x 21"	Case of 6

SHIPPING INFORMATION: F.O.B. Calhoun, GA



Ergonomic, Safety & Anti-Fatigue Matting

A. 1/2" K-Marble

CAT. NO.	DESCRIPTION	THICKNESS	SIZE	UOM
39-064-Color-2X3	1/2" K-Marble Foot PVC	1/2"	2' x 3'	Each
39-064-Color-3X5	1/2" K-Marble Foot PVC	1/2"	3' x 5'	Each
39-064-Color-2X60	1/2" K-Marble Foot PVC	1/2"	2' x 60'	Each
39-064-Color-3X60	1/2" K-Marble Foot PVC	1/2"	3' x 60'	Each
39-064-Color-4X60	1/2" K-Marble Foot PVC	1/2"	4' x 60'	Each

SPECIAL LENGTH CUTS UP TO 60' IN LENGTH

39-064-Color-2'CutsX?	1/2" K-Marble Foot PVC	1/2"	2' Widths up to 60' in Length	Sq. Ft.
39-064-Color-3'CutsX?	1/2" K-Marble Foot PVC	1/2"	3' Widths up to 60' in Length	Sq. Ft.
39-064-Color-4'CutsX?	1/2" K-Marble Foot PVC	1/2"	4' Widths up to 60' in Length	Sq. Ft.

Colors: Black/White (0908), Blue (0500), Gray/Black/White (0700)

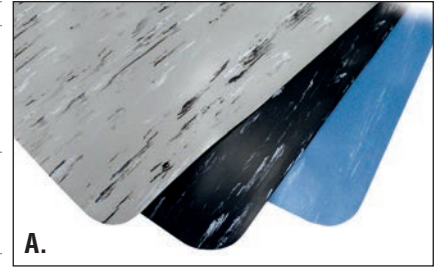

A.

B. 7/8" Safety Tru Tread

CAT. NO.	DESCRIPTION	THICKNESS	SIZE	UOM
SAFETY DRAINAGE MATS 4-SIDED B - BLACK/YELLOW				
46-504-0903-40X52	7/8" Safety Tru Tread	7/8"	40" x 52"	Each
46-504-0903-40X64	7/8" Safety Tru Tread	7/8"	40" x 64"	Each
46-504-0903-40X124	7/8" Safety Tru Tread	7/8"	40" x 124"	Each

SAFETY DRAINAGE MATS 4-SIDED B - BLACK/ORANGE

46-504-0933-28X40	7/8" Safety Tru Tread	7/8"	28" x 40"	Each
46-504-0933-40X52	7/8" Safety Tru Tread	7/8"	40" x 52"	Each
46-504-0933-40X64	7/8" Safety Tru Tread	7/8"	40" x 64"	Each
46-504-0933-40X124	7/8" Safety Tru Tread	7/8"	40" x 124"	Each

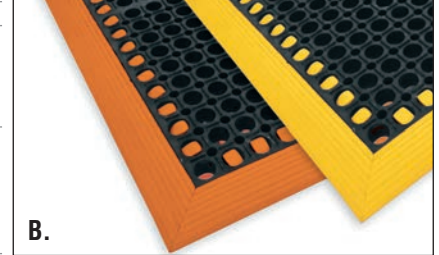

B.

C. 1/2" Work Step

CAT. NO.	DESCRIPTION	THICKNESS	SIZE	UOM
39-378-0920-30000500	WorkStep	1/2"	3' x 5'	Each
39-378-0920-30001000	WorkStep	1/2"	3' x 10'	Each
39-378-0920-30001500	WorkStep	1/2"	3' x 15'	Each
39-176-0920-30000500	WorkStep w/Grit Tuff	1/2"	3' x 5'	Each
39-176-0920-30001000	WorkStep w/Grit Tuff	1/2"	3' x 10'	Each
39-176-0920-30001500	WorkStep w/Grit Tuff	1/2"	3' x 15'	Each



C.

D. Plush Tuff Olefin Entrance Matting

CAT. NO.	DESCRIPTION	SIZE	UOM
CARPET MATS STANDARD			
01-030-Color-20000300	Plush Tuff Olefin	2' x 3'	Each
01-030-Color-30000400	Plush Tuff Olefin	3' x 4'	Each
01-030-Color-30000500	Plush Tuff Olefin	3' x 5'	Each
01-030-Color-30000600	Plush Tuff Olefin	3' x 6'	Each
01-030-Color-30001000	Plush Tuff Olefin	3' x 10'	Each
01-030-Color-40000600	Plush Tuff Olefin	4' x 6'	Each
01-030-Color-40000800	Plush Tuff Olefin	4' x 8'	Each
01-030-Color-30006000	Plush Tuff Olefin	3' x 60'	Each
01-030-Color-40006000	Plush Tuff Olefin	4' x 60'	Each
01-030-Color-60006000	Plush Tuff Olefin	6' x 60'	Each

SPECIAL LENGTH CUTS UP TO 60' IN LENGTH

01-030-Color-3'CutsX?	Plush Tuff Olefin	3' Widths up to 60' in Length	Sq. Ft.
01-030-Color-4'CutsX?	Plush Tuff Olefin	4' Widths up to 60' in Length	Sq. Ft.
01-030-Color-6'CutsX?	Plush Tuff Olefin	6' Widths up to 60' in Length	Sq. Ft.

Colors: Charcoal (1701), Beige (1405), Walnut (1403), Red/Black (2190), Blue (1500), Smoke (1714), Hunter Green (1210)



D.

E. RBI Matting

CAT. NO.	DESCRIPTION	SIZE	UOM
01-033-Color-20000300	Apache Rib	2' x 3'	Each
01-033-Color-30000400	Apache Rib	3' x 4'	Each
01-033-Color-30000500	Apache Rib	3' x 5'	Each
01-033-Color-30000600	Apache Rib	3' x 6'	Each
01-033-Color-30001000	Apache Rib	3' x 10'	Each
01-033-Color-40000600	Apache Rib	4' x 6'	Each
01-033-Color-40000800	Apache Rib	4' x 8'	Each
01-033-Color-30006000	Apache Rib	3' x 60'	Each
01-033-Color-40006000	Apache Rib	4' x 60'	Each
01-033-Color-60006000	Apache Rib	6' x 60'	Each

SPECIAL LENGTH CUTS UP TO 60' IN LENGTH

01-033-Color-3'CutsX?	Apache Rib	3' Widths up to 60' in Length	Sq. Ft.
01-033-Color-4'CutsX?	Apache Rib	4' Widths up to 60' in Length	Sq. Ft.
01-033-Color-6'CutsX?	Apache Rib	6' Widths up to 60' in Length	Sq. Ft.



E.

SHIPPING INFORMATION: F.O.B. Calhoun, GA

SAFETY



MATS FOR PROFESSIONAL USE

Ergonomic, Anti-Fatigue & Safety Matting

Cushion Trax® #479

Diamond surface provides non-directional slip resistance. Choose your level of comfort for a variety of single or multi-shift dry applications needing fatigue prevention and sure footing.

Diamond Sof-Tred™ #419

The only mid-priced/high-performance anti-fatigue sponge mat available. Durability approaches that of competitive "laminated" mats. Extends service life by 50%.

Saddle Trax™ - Grande™ #979

The durable vinyl diamond-plate design provides non-directional traction and is easy to clean. Vinyl top surface made from 100% recycled PVC.

Cushion-Ease® #550

Recommended for wet environments where comfort and durability are critical. A resilient rubber compound and unique support design offers exceptional fatigue relief. Large hole drainage design keeps moisture and debris free from worker platform.

Cushion-Ease® Solid #556

Recommended for dry environments where comfort and durability are critical. A resilient rubber compound and unique support design offers exceptional fatigue relief. Can be locked together on-site with Cushion-Ease® #550.

Beveled Drain Step Classic #504

Features molded-in beveled edges to reduce trip hazards. Drainage system removes liquid and debris from worker platform. Low profile for easy cart access.

A. Cushion Trax® #479

Durable vinyl diamond-plate top surface is combined with dense closed cell foam base utilizing NoTrax® exclusive UniFusion™ technology. Top surface is made from 100% recycled PVC. RedStop™ backing virtually eliminates the slipping and sliding of mat. Overall mat thickness is ¾". Sloped beveled foam on all four undersides affords easy access onto and off of mat. Laminate.

CAT. NO.	DESCRIPTION	LBS.
479	2' x 3' Black	9
479	2' x 3' Black/Yellow	9
479	3' x 5' Black	20
479	3' x 5' Black/Yellow	20

SPECIAL LENGTH CUTS UP TO 75' IN LENGTH

479	2' Width/Up to 75' in Length - Black
479	2' Width/Up to 75' in Length - Black/Yellow
479	3' Width/Up to 75' in Length - Black
479	3' Width/Up to 75' in Length - Black/Yellow

▲ WARNING: Cancer and reproductive harm - www.P65Warnings.ca.gov

B. Diamond Sof-Tred™ w/Dyna-Shield® #419

Diamond-plate top pattern to fit the needs of work stations where longer lasting fatigue protection is required. Unlike urethane or acrylic top coats that are applied after the mat is produced, Dyna-Shield® is manufactured into the mat to provide long-wearing protection. Outperforms competitive products in tear resistance and tensile strength. Mat thickness is ½". All four sides are beveled to minimize trip hazards. Sponge.

CAT. NO.	DESCRIPTION	LBS.
419	2' x 3' Black	5
419	2' x 3' Black/Yellow	5
419	3' x 5' Black	12.2
419	3' x 5' Black/Yellow	12.2

SPECIAL LENGTH CUTS UP TO 60' IN LENGTH

419	2' Width/Up to 60' in Length - Black
419	2' Width/Up to 60' in Length - Black/Yellow
419	3' Width/Up to 60' in Length - Black
419	3' Width/Up to 60' in Length - Black/Yellow

▲ WARNING: Cancer and reproductive harm - www.P65Warnings.ca.gov

C. Saddle Trax™ - Grande™ #979

Saddle Trax™ is thicker, heavier and stronger, engineered to meet the toughest requirements of today's industrial applications and is particularly suited for multi-shift operations in dry work areas. At a full 1" thick, it is the ultimate anti-fatigue product, maximizing worker productivity and comfort. Laminate.

CAT. NO.	DESCRIPTION	LBS.
979	2' x 3' Black	12
979	2' x 3' Black/Yellow	12
979	3' x 5' Black	30
979	3' x 5' Black/Yellow	30

SPECIAL LENGTH CUTS UP TO 75' IN LENGTH

979	2' Width/Up to 75' in Length - Black
979	2' Width/Up to 75' in Length - Black/Yellow
979	3' Width/Up to 75' in Length - Black
979	3' Width/Up to 75' in Length - Black/Yellow

▲ WARNING: Cancer and reproductive harm - www.P65Warnings.ca.gov

D. Cushion-Ease® #550*

Easy to snap together mats on-site for custom work station platforms. Optional nitrile rubber borders available for trip-resistant platform. Overall thickness is ¾". Rubber.

CAT. NO.	DESCRIPTION	LBS.
550	3' x 3' Black	24

▲ WARNING: Cancer and reproductive harm - www.P65Warnings.ca.gov

E. Cushion-Ease® Solid #556*

Easy to snap together mats on-site for custom work station platforms. Optional nitrile rubber borders available for trip-resistant platform. Overall thickness is ¾". Rubber.

CAT. NO.	DESCRIPTION	LBS.
556	3' x 3' Black	24

▲ WARNING: Cancer and reproductive harm - www.P65Warnings.ca.gov

F. Beveled Drain Step Classic #504*

Available in general purpose (black) and heavy-duty (red) rubber compounds for varying degrees of grease and oil protection. Lightweight for easy handling and cleaning. Thickness is ½". Rubber.

CAT. NO.	DESCRIPTION	LBS.
504	3' x 5' Black	23

▲ WARNING: Cancer and reproductive harm - www.P65Warnings.ca.gov

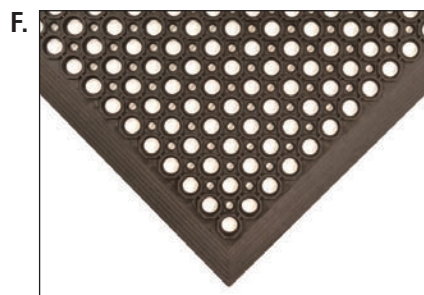
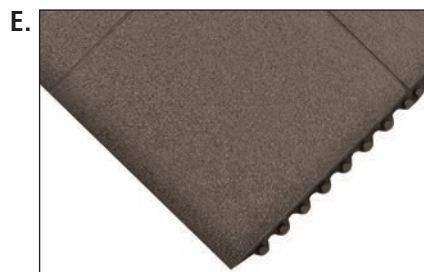



A. Durite 108

Perfect for in-plant applications at workstations, along assembly lines, in front of machines, or in aisles and passages. Special sizes, beveled edges and irregular configurations available upon request. **Material:** Recycled rubber links woven on galvanized wires. **Thickness:** 5/8"; **Surface:** Open mesh herringbone weave **Color:** Black.

CAT. NO.	SIZE
108H2030	20' x 30"
108H2437	24' x 37"
108H3048	30' x 48"
108H3660	36' x 60"
108H3672	36' x 72"

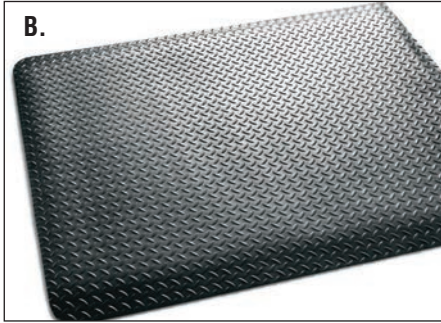

B.

B. Diamond-Dek Sponge HD (7/8" Thick)

Sponge backing is resistant to many common oils, alkylides and acids. **Material:** 5/32" vinyl Diamond-Dek surface bonded to a resilient 3/4" thick sponge. **Thickness:** 7/8". **Surface:** Diamond tread. **Colors:** Solid black, black with yellow safety border.

CAT. NO.	SIZE
442SHD23	2' x 3'
442SHD35	3' x 5'
442CHD24	2' up to 75'
442CHD36	3' up to 75'
442CHD48	4' up to 75'



C.

C. Diamond-Dek Sponge (5/16" Thick)

Sponge backing is resistant to many common oils, alkylides and acids. **Material:** 5/32" vinyl Diamond-Dek surface bonded to a resilient 3/8" thick sponge. **Thickness:** 5/16". **Surface:** Diamond tread. **Colors:** Solid black, black with yellow safety border.

CAT. NO.	SIZE
442S23	2' x 3'
442S35	3' x 5'
442C24	2' up to 75'
442C36	3' up to 75'
442C48	4' up to 75'

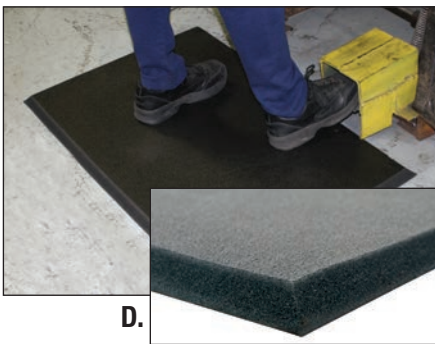

D.

D. Comfort Stand HD (7/8" Thick)

Built in beveled edges and the embossed textured surface provide safety and traction. Not recommended for use with cleated shoes and spiked heels. **Material:** Polyvinyl chloride & butadiene-nitrile rubber textured surface. **Thickness:** 7/8" +/- 10% (7/8", 875 mils). **Color:** Black

CAT. NO.	SIZE
597S23BK	2' x 3'
597S34BK	3' x 4'
595S35BK	3' x 5'
597S46BK	4' x 6'
597C24BK	2' up to 30'
597C36BK	3' up to 30'
597C48BK	4' up to 30'



Ergonomic, Anti-Fatigue & Safety Matting

Durite 108

One of the toughest, long-lasting anti-fatigue mats available today. The original tire-link mat helps create foot comfort and safety traction, especially where people stand for long period of time – indoors or out. The open mesh construction provides excellent drainage and dirt retention. Durite 108 mats are easily rolled up for thorough cleaning and convenient storage.

Diamond-Dek Sponge HD

Heavy duty matting with diamond tread pattern provides sure footing in a variety of applications. Beveled edges and colored safety borders promote safety while the industrial grade sponge reduces fatigue on legs and back.

Diamond-Dek Sponge

Heavy duty matting with diamond tread pattern provides sure footing in a variety of applications. Beveled edges and colored safety borders promote safety while the industrial grade sponge reduces fatigue on legs and back.

Comfort Stand HD

The ultimate comfort from a single layer sponge. Comfort Stand HD is ideal in industrial, commercial, and retail applications where standing for long periods of time is required. The nitrile sponge mat is 2-3 times more resilient than a standard vinyl sponge mat.

SHIPPING INFORMATION:
1 Week, F.O.B. Norwalk, OH



Heavy-Duty Workbenches

Heavy-Duty Welded Workbenches have an extra strong 7 gauge (0.180") reinforced steel top with rounded comfort edges than can support up to 10,000 lbs. UDL.

Fixed Height Welded Steel Workbenches

Smooth 12 gauge steel top is double-reinforced with angle iron on the underside and gussets in the corners for exceptional strength and rigidity. Supports up to 5000 lbs. UDL.

Welded Steel Workbenches with Butcher Block Tops

Butcher block top is 1¾" thick, helps deaden sounds, and absorbs impact. Replaceable top is attached to an all-welded steel frame. Half lower shelf constructed of 12 gauge steel with 3" high lip at rear. Supports up to 3000 lbs.

SHIPPING INFORMATION:
2 Weeks,
F.O.B. University Park, IL

A. Heavy-Duty Workbenches

- Heavy 2" x 2" angle legs are ¼" thick with welded 7 gauge gussets
- Stationary models have footpads with a 5/8" diameter anchor hole
- Sturdy 12 gauge lower shelf has a 500 lb. capacity for added storage
- All models are welded and ship set up, ready for immediate use
- **Fixed-Height Benches:** 34" high
- **Adjustable-Height Benches:** 28" to 37" high on 1" centers



SIZE D X W	FIXED HEIGHT		ADJUSTABLE HEIGHT	
	CAT. NO.	LBS.	CAT. NO.	LBS.
30" x 36"	WW-3036	151	WW-3036-ADJ	176
30" x 48"	WW-3048	187	WW-3048-ADJ	212
30" x 60"	WW-3060	220	WW-3060-ADJ	245
36" x 60"	WW-3660	250	WW-3660-ADJ	275
36" x 72"	WW-3672	287	WW-3672-ADJ	312
42" x 84"	WW-4284	421	WW-4284-ADJ	446

B. Fixed Height Welded Steel Workbenches

- Legs and lower braces are 1½" x 1½" x 3/16" thick angle iron
- Legs have footpads with a 5/8" hole for mounting to the floor
- Sturdy 12 gauge lower shelf has a 500 lb. capacity for added storage
- These all-welded units ship fully assembled and ready for immediate use
- 36" overall height
- **Workbench with Half Lower Shelf:** Half depth 12 gauge lower shelf with lip at rear provides room for additional storage while leaving ample room for legs when seated. Capacity 500 lbs.
- **Workbench with Open Base:** Angle iron cross braces are centered to allow leg room on both sides



SIZE D X W X H	CAP.	WITH LOWER SHELF		WITH OPEN BASE	
		CAT. NO.	LBS.	CAT. NO.	LBS.
24" x 48" x 36"	5000	WST2-2448-36	109	WST1-2448-36	87
24" x 60" x 36"	4500	WST2-2460-36	136	WST1-2460-36	109
30" x 48" x 36"	5000	WST2-3048-36	124	WST1-3048-36	98
30" x 60" x 36"	4500	WST2-3060-36	153	WST1-3060-36	121
30" x 72" x 36"	4000	WST2-3072-36	186	WST1-3072-36	142
36" x 60" x 36"	4500	WST2-3660-36	174	WST1-3660-36	136
36" x 72" x 36"	4000	WST2-3672-36	201	WST1-3672-36	157
36" x 84" x 36"	3000	WST2-3684-36	224	WST1-3684-36	177

C. Welded Steel Workbenches with Butcher Block Tops

- Available in fixed and adjustable heights
- Optional factory installed locking drawer measures 13" W x 17" D x 4½" H (right side mount)
- Ships fully assembled and ready for immediate use



		WITHOUT DRAWER		WITH DRAWER	
FIXED HEIGHT MODELS - 37¾" OVERALL HEIGHT					
SIZE D X W	CAT. NO.	LBS.	CAT. NO.	LBS.	
24" x 48"	WSJ2-2448-36	125	WSJ2-2448-36-DR	168	
30" x 48"	WSJ2-3048-36	141	WSJ2-3048-36-DR	184	
30" x 60"	WSJ2-3060-36	169	WSJ2-3060-36-DR	211	
30" x 72"	WSJ2-3072-36	194	WSJ2-3072-36-DR	236	
ADJUSTABLE HEIGHT MODELS - 28¾" TO 42¾" HIGH IN 2" INCREMENTS					
SIZE D X W	CAT. NO.	LBS.	CAT. NO.	LBS.	
24" x 48"	WSJ2-2448-AH	123	WSJ2-2448-AH-DR	166	
30" x 48"	WSJ2-3048-AH	139	WSJ2-3048-AH-DR	182	
30" x 60"	WSJ2-3060-AH	173	WSJ2-3060-AH-DR	215	
30" x 72"	WSJ2-3072-AH	199	WSJ2-3072-AH-DR	241	

Adjustable Height Workbenches

CAT. NO.	W X D	LBS.
Steel Top		
WBA-1-3048S	48" x 30"	98
WBA-1-3060S	60" x 30"	110
WBA-1-3660S	60" x 36"	129
WBA-1-3072S	72" x 30"	127
WBA-1-3672S	72" x 36"	141
WBA-1-3696S	96" x 36"	202
Plastic Laminate Top		
WBA-1-3060P	60" x 30"	133
WBA-1-3660P	60" x 36"	179
WBA-1-3072P	72" x 30"	145
WBA-1-3672P	72" x 36"	179
Compressed Wood Top		
WBA-1-3060C	60" x 30"	150
WBA-1-3660C	60" x 36"	175
WBA-1-3072C	72" x 30"	173
WBA-1-3672C	72" x 36"	204
Hardwood Butcher Block Top		
WBA-1-3060W	60" x 30"	119
WBA-1-3660W	60" x 36"	143
WBA-1-3072W	72" x 30"	140
WBA-1-3672W	72" x 36"	160

WARNING: Cancer - www.P65Warnings.ca.gov

Accessories for Work Stations

Shelf Risers — 12" High

Adds extra storage to benches for tools and testing equipment. Can be double stacked. Riser is 16-gauge steel with a load rating of 200 lbs./square foot evenly distributed. Riser (except 48"W) has knockouts for four duplex outlets and a switch (order optional wiring kit).

CAT. NO.	DESCRIPTION	LBS.
R-1048	Standard Riser w/End Supports 48"W x 10"D	19
RE-1060	Electric Riser w/End Supports 60"W x 10"D	27
RE-1072	Electric Riser w/End Supports 72"W x 10"D	31
RE-1096	Electric Riser w/End Supports 96"W x 10"D	41

Side & Back Rail Kits

Provides 3" high barrier on sides and back to keep small objects from rolling off the bench top. Made of 14-gauge steel.

CAT. NO.	DESCRIPTION	LBS.
SB-3048	Side/Back Stop 48"W x 30"D	12
SB-3060	Side/Back Stop 60"W x 30"D	14
SB-3660	Side/Back Stop 60"W x 36"D	15
SB-3072	Side/Back Stop 72"W x 30"D	16
SB-3672	Side/Back Stop 72"W x 36"D	17
SB-3696	Side/Back Stop 96"W x 36"D	20

Lower Shelf/Foot Rest

Adds extra storage space under bench top. 16-gauge steel shelf doubles as a foot rest.

CAT. NO.	DESCRIPTION	LBS.
S-48	Lower Shelf 48"W x 14"D	16
S-60	Lower Shelf 60"W x 14"D	20
S-72	Lower Shelf 72"W x 14"D	23
S-96	Lower Shelf 96"W x 14"D	31

Stackable Drawer

Has a divider and a removable tray. Drawer operates smoothly on nylon rollers and can be set on top of the bench or mounted below the top. Drawers can be bolted together for additional storage.

CAT. NO.	DESCRIPTION	LBS.
WBD-1MG	Drawer 15"W x 18"D x 7"H	18
CL-1	Drawer Cam Lock	—



Steel Top



Plastic Laminate Top



Compressed Wood Top



Hardwood Butcher Block Top; shown with optional accessories added

tennsco
Storage Made Easy

Adjustable Height Workbenches

Workbench height is adjustable from 29½" to 37" to meet changing work requirements. Welded 13-gauge legs have knockouts for one duplex electrical outlet in each leg. Stringer across the back ties the legs together, adding rigidity to the bench. Standard bench includes top, stringer and legs. Choose from four top options: steel, plastic laminate, compressed wood or hardwood butcher block. Accessories include a 12" high shelf riser, 3" high side and back rail kit, lower shelf/foot rest, stackable drawer with optional cam lock, wiring kit and caster kit. Shipped unassembled. Color: medium gray.

Wiring Kit for Shelf Riser

Pre-wired for quick and easy installation. Comes complete with four duplex receptacles, on/off switch with pilot light, 8-foot grounded cord and plug, 15 amp, 115-volt service and circuit breaker. For use in Shelf Riser.

CAT. NO.	LBS.
WK-1	3



Caster Kits

Adds mobility to the workbench (for 30" and 36" deep benches). Kit includes two mounting brackets with 5" diameter casters. Mounting brackets bolt to the workbench legs. Two casters are fixed and two are swivel with locks. The kit raises the bench 6⅞".

CAT. NO.	LBS.
WBCK-3036	16



SHIPPING INFORMATION:
5 Days, F.O.B. Dickson, TN

A. Open Style

SR-57: Stationary desk with foot rest (height is 53"); ships partially assembled. **SR-57M:** Mobile desk on casters with full lower shelf (height is 52"); ships partially assembled and includes casters.

CAT. NO.	DESCRIPTION	LBS.
SR-57	Open style	97
SR-57M	Open style w/casters	113



A.

SR-57M

B. Closed Style

SR-58: Stationary desk with 26½" h storage cabinet with three-point locking system and one adjustable shelf (height 53"); ships knocked down. **SR-58M:** Mobile desk on casters same as SR-58 (height 52"); ships knocked down and includes casters.

CAT. NO.	DESCRIPTION	LBS.
SR-58	Closed style	155
SR-58M	Closed style w/casters	164



B.

SR-58

C. Wall-Mounted Style

SR59: Mounts to the wall to conserve floor space; ships partially assembled.

CAT. NO.	DESCRIPTION	LBS.
SR-59	Wall-mounted style	83



C.



Foreman's Desks

- Angled writing surface with compartmentalized storage riser at the back for forms and papers
- Locking drawer, 22" w x 23" d x 3½" h; supplied with two keys
- 34½" w x 29" d
- Mobile units have 5" PVC casters
- Medium gray powder-coated finish

SHIPPING INFORMATION: 5 Days, F.O.B. Dickson, TN



Complete Workbenches

The Rousseau system offers a multitude of possible layouts, thanks to numerous accessories which allow you to create a work center that responds to your exact need.

The Rousseau Advantages

- The upper frame structure can be installed on most industrial workbenches on the market.
- Reconfiguring your upper frame is easy and can be done without tools.
- High-quality drawers feature: 100% full extension; 100-lb. capacity per drawer; precision ball bearing slide system

Under the Work Surface Accessories Available

- Pedestals; drawer unit; shelf; ergonomic footrest; keyboard tray; and much more

A. Workbench with Stringer — 30" D x 34" H

	60" W	72" W
TOP	CAT. NO.	CAT. NO.
Laminated Wood	WSA2031	WSA2035
Steel	WSA1031	WSA1035
Plastic Laminate	WSA3031	WSA3035
Acrylic/PVC	WSA9031	WSA9035



B. Workbench with Cabinet — 30" D x 34" H

- Drawer sizes: two 3", one 6" and one 12"; folder hanging bar, partitions and dividers available; central locking mechanism on the cabinet

	60" W	72" W
TOP	CAT. NO.	CAT. NO.
Laminated Wood	LG2101L3C	LG2102L3C
Steel	LG1101L3C	LG1102L3C
Plastic Laminate	LG3101L3C	LG3102L3C
Acrylic/PVC	LG9101L3C	LG9102L3C



C. Electronic Workbench with Cabinet — 30" D x 52" H

- Drawer sizes: four 3" and two 6"; partitions and dividers available
- Central locking mechanism on the cabinet
- 12" deep shelf - same material as top
- Electric outlet on both sides

	60" W	72" W
TOP	CAT. NO.	CAT. NO.
Laminated Wood	LG2104L3C	LG2105L3C
Plastic Laminate	LG3104L3C	LG3105L3C
Dissipative	LG4104L3C	LG4105L3C



D. Basic Workstation

- Single upper frame 28" W x 48" H
- Includes 2 tiltable shelves; 2 plastic bin rails & 5 plastic bins; 1 power outlet strip; 6 partial dividers
- Includes 1 vertical adaptor for electrical and air outlets; 2 open legs; 1 stringer

CAT. NO.	TOP	W X D X H
WSC0133	Steel	60" x 30" x 80"

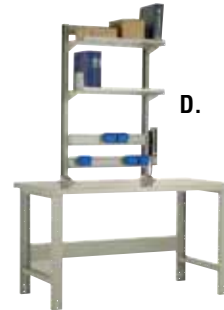

E. Assembly Workstation

- Double upper frame 56" W x 48" H
- Includes 2 plastic bin rails & 5 plastic bins; 1 document holder with arm; 1 perforated panel

CAT. NO.	DESCRIPTION	W X D X H
LC3001	Plastic Laminate	60" x 30" x 80"



F. Upper Frame

- Can be installed on most industrial workbenches on the market

CAT. NO.	DESCRIPTION	W X H
WM11-2848	Single-Unit Frame	28" x 48"
WM11-5648	Double-Unit Frame	56" x 48"



(Image as reference only)

G. Cabinets

- All models include a central locking mechanism and a 4" base
- Drawers: 100% full extension; 100-lb. capacity per drawer; high quality ball-bearing slides
- Many drawer accessories available: partitions and dividers, foam for tools, plastic bins, folder hanging bar and PVC liner

CAT. NO.	DRAWER DESCRIPTION	W X D X H	LBS.
L3ABD-2418L3C	One 4", two 5" and one 6"	18" x 21" x 28"	81
L3ABG-2418L3C	One 4", two 5" and one 6"	18" x 27" x 28"	94
L3ABD-2816L3C	Two 4", two 8"	18" x 21" x 32"	89
L3ABG-2816L3C	Two 4", two 8"	18" x 27" x 32"	103
L3ABD-4034L3C	One 4", two 5", one 6" and two 8"	18" x 21" x 44"	123
L3ABG-4034L3C	One 4", two 5", one 6" and two 8"	18" x 27" x 44"	142



L3ABD-2418L3C

L3ABD-2816L3C

L3ABD-4034L3C

Optional Locking Features

CAT. NO.	DESCRIPTION
HA51-L3	Lock for L Drawer (L3)
HA49-L3	Lock for L Door (L3)

SHIPPING INFORMATION: 3-5 Weeks, F.O.B. Williston, VT



A.

A. Full Function Packing Station

Basic packing station with the addition of a roll bar kit, cutter bar and knife assembly, and metal drawer. Carton rack: 6 dividers.

CAT. NO.	BENCH SIZE	LEG ADJUST	DOCUMENT SHELF	METAL DRAWER OD.
PBS-911	83" x 33"	29"-36"	64" x 9" x 9½"	15½" x 19½" x 7½"



B.

B. Over-The-Conveyor Manifest Station

This freestanding stand is ideal for shipping and manifesting areas. Stand comes complete with (2) CRT monitor holders with keyboard trays, (2) flat printer shelves, and (1) slat wall panel with accessories. Accessories include (1) label dispenser, (1) literature tray, (3) small parts storage bins and (3) slat wall hooks.

CAT. NO.	W X D X H
MS-1302	62" x 30" x 70"

C. Roll Storage Stand

Can be used with the rotary shear or as a stand-alone system. Stand is constructed of 1½", 16 gauge steel tubing and supports up to 300 lbs. Sway supports are provided for added strength. 48" diameter roll capacity. Casters are available to make stand portable - sold separately; call for pricing.

CAT. NO. STAND	MAX. MATERIAL WIDTH	CAT. NO. CUTTER	MAX. MATERIAL WIDTH
RS 3044	30"	RC 3044	30"
RS 4054	40"	RC 4054	40"
RS 5064	50"	RC 5064	50"
RS 6074	60"	RC 6074	60"
RS 7286	72"	RC 7286	72"

Shear Cutter

The rotary Shear Cutter comes completely assembled and ready to operate. The rotary knife is safely enclosed in the cutting head and cuts a wide variety of material:

- Paper
- Plastic
- Vinyl
- Packing Foam
- Bubble
- Fiberglass

D. Portable Carton Rack

- 48" x 18" x 24"
- 5 dividers

CAT. NO.	DESCRIPTION
D-9060	Rack
D-9078	Casters

E. Carton Stand with Deck

- Adjustable flat shelf w/4 dividers
- 4" casters – 2 fixed, 2 swivel

CAT. NO. CS-1102



Packing Stations

Pack-Bench Systems can help organize packaging areas, improving the efficiency and increasing the productivity of workers in the area.



C.

*Stand and cutter sold separately.

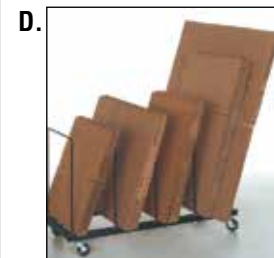

D.

*Shown with optional casters.



E.

SHIPPING INFORMATION: 1-2 Weeks, F.O.B. Buffalo, NY

Height Adjustable Steel Stools

CAT. NO.	DESCRIPTION	LBS.
HBRB18	Steel Hardboard Round Seat w/Backrest 18"-27"	15.0
HBRB24	Steel Hardboard Round Seat w/Backrest 24"-33"	15.0
HB18	Steel Hardboard Seat 18"-27"	8.7
HB24	Steel Hardboard Seat 24"-33"	9.5
HBSB18	Steel Hardboard Square Seat w/Back Rest 18"-27"	10.7
HBSB24	Steel Hardboard Square Seat w/Back Rest 24"-33"	11.5
UPSB18	Upholstered Seat & Back Rest 18"-27"	15.2
UPSB24	Upholstered Seat & Back Rest 24"-33"	16.0
UPS18	Upholstered Seat 18"-27"	8.7
UPS24	Upholstered Seat 24"-33"	9.5



SHIPPING INFORMATION: Northeastern: Robbinsville, NJ, 2 days; Southeastern: Buford, GA, 2 days; Midwest: Pleasant Prairie, WI, 2 days; Western: North Las Vegas, NV, 2 days.



Height Adjustable Steel Stools

Heavy-duty 18-gauge x 7/8" tubular steel electrically seam-welded construction assures strength and rigidity. Convenient steel foot ring. Telescoping legs adjust on 1" increments. Durable gray baked enamel finish. All models sold 2 per package.

BENCH IN A BOX

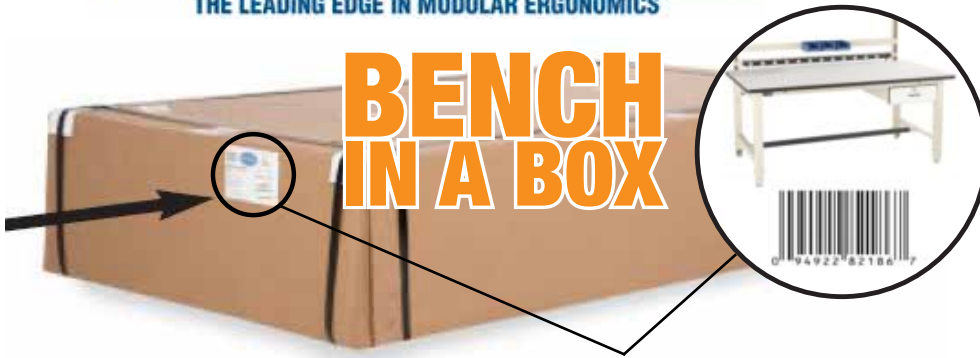

**EVERYTHING YOU NEED
IS IN THE BOX!**

Each bench is packaged separately and complete!

Bar coded inventory for your warehouse. With the bench in a box series you can easily inventory the units until you need them. The bench in the box series has each bench packaged separately and complete. Prekitted units take the guess work out of configuring the bench you need.



Models A, B, C, D

Model A Part # BIB1
Plastic Laminate Bench

- 60"L x 30"D x 30" TO 36"H Base Bench
- Footrest, 6" drawer with lock, 12 outlet power supply
- Overhead adjustable light
- 12" x 60" laminate shelf. Bin Holder

Model B Part # BIB2
Same items but with ESED laminate

Model C Part # BIB3
Same items but 72"L x 30" D with plastic laminate

Model D Part # BIB4
Same items but 72"L x 30" D with ESD laminate

⚠ WARNING: Cancer - www.P65Warnings.ca.gov

SHIPPING INFORMATION: 5 Days, F.O.B. Haverhill, MA



Models Q, R, S, T

Model Q Part # BIB15
Plastic Laminate Bench

- 60"L x 30"D x 30" TO 42"H
- Height Adjustable Ergonomic Base Bench
- 6" drawer, Bin Holder
- 120 volt 15 amp power supply
- Overhead light
- 60" x 12" Cantilever shelf
- Frame painted light blue

Model R Part # BIB16
Same items as listed above with ESD laminate

⚠ WARNING: Cancer - www.P65Warnings.ca.gov

SHIPPING INFORMATION: 5 Days, F.O.B. Haverhill, MA

Model S Part # BIB17
Plastic Laminate Bench

- 72"L x 30"D x 30" TO 42"H
- Height Adjustable Ergonomic Base Bench
- 6" drawer, Bin Holder
- 120 volt 15 amp power supply
- Overhead light
- 72" x 12" Cantilever Shelf
- Frame painted light blue

Model T Part # BIB18
Same items as listed above with ESD laminate

Bench in a box

Cantilever Workbench

PROLINE
THE LEADING EDGE IN MODULAR ERGONOMICS



Models K and L

Model K Part # BIB19
Plastic Laminate Bench

Includes:

60" L x 30" D x 30" to 36" H base bench. Power supply, Bin Holder, 6" drawer, Bin Holder, 12" D shelf, deluxe light fixture. Two tone color scheme dark blue frame with black options.

Model L Part # BIB20
Same items as listed above with ESD Laminate

(All bench in a box series ESD benches include the grounding kit.)

Cantilever Workbenches
CAT. NO. BIB19
CAT. NO. BIB20

SHIPPING INFORMATION: 4-6 Weeks, F.O.B. Haverhill, MA

Bench in a box

Technical Workbenches

Model M Part # BIB11
Plastic Laminate Bench

Includes:

60" L x 30" D x 30" to 36" H base bench. 6" and 12" drawer with lock. Pad Lock Drawer Riser 60" L x 12" D x 18" H with built in outlets. Footrest. 90 degree rolled front edge.

Model N Part # BIB12
Same items as listed above with ESD Laminate

Model O Part # BIB13
Same items as listed above with Plastic Laminate and 72" L

Model P Part # BIB14
Same items as listed above with ESD Laminate and 72" L



Models M,N,O and P

Technical Workbenches
CAT. NO. BIB11
CAT. NO. BIB12
CAT. NO. BIB13
CAT. NO. BIB14

SHIPPING INFORMATION: 5 Days, F.O.B. Haverhill, MA

⚠️ WARNING: Cancer - www.P65Warnings.ca.gov

Bench in a box

Packaging Benches

Model E Part # BIB5
Plastic Laminate Bench



- Includes:**
- 60" L x 30" D x 30" to 36" H Pack Bench.**
- Lower shelf with dividers.**
- Storage Shelf with 4" clearance.**
- 60" high Uprights.**
- Paper spool holder.**
- Overhead light,**
- 60" x 18" Corrugated Storage Shelf.**
- Frame painted light gray.**
- 120 volt 15 amp power supply.**
- Bin Holder, 12" deep cantilever shelf.**

Model F Part # BIB6
Same items as listed above with ESD Laminate

Model G Part # BIB7
Same items as listed above with Solid Maple Surface



Models E, F, H and I

Model H Part # BIB8
Plastic Laminate Bench

- Includes:**
- 72" L x 30" D x 30" to 36" H Pack Bench.**
- Lower shelf with dividers.**
- Storage Shelf with 4" clearance.**
- 60" high Uprights.**
- Paper spool holder.**
- Overhead light,**
- 72" x 18" Corrugated Storage Shelf.**
- Frame painted light gray.**
- 120 volt 15 amp power supply.**

Model I Part # BIB9
Same items as listed above with ESD Laminate

Model J Part # BIB10
Same items as listed above with Solid Maple Surface



Models J and G

Packaging Benches

- CAT. NO. BIB5
- CAT. NO. BIB6
- CAT. NO. BIB7
- CAT. NO. BIB8
- CAT. NO. BIB9
- CAT. NO. BIB10

SHIPPING INFORMATION: 5 Days, F.O.B. Haverhill, MA

WARNING: Cancer - www.P65Warnings.ca.gov

PACKING TABLE



1. ROLL DISPENSER

Ideal for holding rolls of packing material.

2. CHOICE OF TOP

1-1/2" steel and 1-3/4" butcher block tops available.

3. ADJUSTABLE LEGS

Bench height is adjustable on 1-1/2" increments from 27-7/8" to 35-3/8"

4. TASK LIGHT (Optional)

Task light provides ample light across your entire workspace.

5. POWER RAIL (Optional)

Mounted power rail is very convenient for electric tools.

6. 14" DEEP LOWER SHELF

Easily accessible lower shelf allows for storage of bulky items

7. CONVENIENT DIVIDER SHELF

Perfect for storing boxes or oversized cartons.

8. BIN RAIL (optional)

Accommodates plastic or metal bins for storing parts. (Bins not sold by Tennsco)

9. EYE LEVEL SHELF

Perfect for storing items within arms reach.



Increase your shipping efficiency with Tennsco's Packing Table. With our modular design, Tennsco's Packing Table is scalable with the needs of your business – add or remove accessories as required. All tables feature either a 12 gauge steel or butcher block work surface, and are available in 30" or 36" deep varieties. Each table comes standard with a heavy duty 14 gauge lower shelf with a 350 lbs capacity and 14 gauge adjustable legs that adjust from 27-7/8" - 35-3/8". Sturdy rear uprights support an upper divided shelf, roll dispenser and storage shelf for your packing and shipping supplies. Optional accessories include a power rail, a bin rail for plastic bins and a task light. All Tennsco Products are Proudly Made in the USA.

Steel Top Packing Table

W	X	D	X	H	CAT. NO	WEIGHT
72"	X	30"	X	83 7/16"	APT-3072S	252
72"	X	36"	X	83 7/16"	APT-3672S	271

Butcher Block Top Packing Table

W	X	D	X	H	CAT. NO	WEIGHT
72"	X	30"	X	83 7/16"	APT-3072W	275
72"	X	36"	X	83 7/16"	APT-3672W	295

Optional Accessories

W	X	D	X	H	CAT. NO	WEIGHT
Power Rail						
57 3/32"	X	2 1/2"	X	1 3/4"H	PTP-60	12

Bin Rail						
57 3/32"	X	3 7/8"	X	4 3/16"	TWBR-60	7

Task Light						
50 5/32"	X	8"	X	1 25/32"	TWCTL-48	14

Task Light Bracket Kit *required for task light						
60"	X	13 1/2"	X	3 1/2"	TWLB-60	8.2

STEEL Strapping, Tools, and Accessories

A. Steel Strapping

CAT. NO.	DESCRIPTION	BREAK STRENGTH	APPROX. LENGTH PER COIL
109046	½" x .020	1180 lbs.	3089'
109062	¾" x .020	1770 lbs.	2059'
109068	¾" x .029	2770 lbs.	1647'
109051	1¼" x .029	5530 lbs.	852'

WARNING: Cancer and reproductive harm - www.P65Warnings.ca.gov



A.

B. Steel Strap Tensioner

CAT. NO.	DESCRIPTION
104092	Tensioner for ¾" to ¾"
104086	Tensioner for 1¼"

WARNING: Cancer and reproductive harm - www.P65Warnings.ca.gov



104092

B.



104086

C. Strap Cutter

CAT. NO.	DESCRIPTION
104112	Cutter for ¾" to 1¼"

WARNING: Cancer and reproductive harm - www.P65Warnings.ca.gov



C.

D. Sealer

CAT. NO.	DESCRIPTION
SDD12	Sealer for ½" x .015 - ½" x .025 Regular Duty
SDD34	Sealer for ¾" x .015 - ¾" x .025 Regular Duty
SSD114	Sealer for Side Action 1¼" x .025 - .035 Regular Duty



MIP1100

D.



RCD1431

E. Open Seals

CAT. NO.	DESCRIPTION	QTY./CASE
SS12S	½" Snap-on	5000
SS34S	¾" Snap-on	5000
121860	Seals for ¾"	200
119209	Seals for 1¼"	700



Standard Seals



E.

121860



119209

F. Mobile Hand Cart

For use with both steel and plastic strapping

CAT. NO.	DESCRIPTION	LBS.
DSHD	Heavy Duty Oscillated Steel Dispenser	55



F.

Packaging Supplies

Steel Strapping

Maximum footage with average 26% more feet per coil. Maximum tooling productivity with no new tooling required. Maximum break strength – it is lighter in gauge and the same break strength as regular oscillated.

Deluxe Tensioner

Designed for high volume work. Easy and fast package securing.

Sealer

Provides secure crimping action. Built for daily hard work.

Packaging Supplies

Polypropylene & Polyester Strapping

Excellent for rigid, heavy loads. Features great ability to retain high tension. An economical alternative to steel strapping. Primary characteristics include high elongation recovery but low retained tension. Available in both hand and machine grades and can be sealed using buckles, seals, heat seals, or friction welds. An excellent choice for light-duty palletizing, unitizing, carton closing, and bundling. Usable in all semi-automatic strapping machinery.

SHIPPING INFORMATION: 3-5 Days, F.O.B. Cincinnati, OH

PLASTIC Strapping, Tools, and Accessories

A. Polypropylene Strapping

Standard hand grade plastic strapping used to secure pallets, bundles and boxes.

CAT. NO.	DESCRIPTION	COLOR	TENSILE
HCLD	½" x 9000' embossed	Black	300 lbs.
HC500	½" x 7200' embossed	Black	500 lbs.
HC1260	½" x 7200' embossed	Black	600 lbs.
108958	¾" x 2850'	Black	750 lbs.



A.

B. Polypropylene Strap Tensioner

CAT. NO.	DESCRIPTION
TPXHD	Extra Heavy Duty Windlass Plastic Strapping Tensioner - Polypropylene and Polyester Strapping



B.

C. Open Seals

CAT. NO.	DESCRIPTION	QTY./CASE
OMS12	½" Open Metal Seals - Galvanized for Polypropylene Strapping	1000
OMS58	¾" Open Metal Seals - Galvanized for Polypropylene Strapping	1000



C.

D. Mobile Hand Cart

For use with both steel and plastic strapping

CAT. NO.	DESCRIPTION	LBS.
DSUS	Adjustable Plastic Strapping Dispenser	55



D.

E. Automatic Plastic Strapping Tool

Pulls up to 600# tension - ½", ¾" polypropylene or polyester strapping; .019" - .030" - DC brushless motor can be set for Full Auto, Semi or Manual modes; with side strap guide; with 2 batteries and charger.

CAT. NO.	DESCRIPTION
B600	Battery-Powered Friction Weld Tool



E.

F. Polyester Strapping

Smooth waxed polyester.

CAT. NO.	DESCRIPTION	COLOR	TENSILE
HPC58PTG	¾" x .035 x 4000'	Green	1400 lbs.



F.

G. Manual Plastic Sealer

CAT. NO.	DESCRIPTION	LBS.
113369	Sealer for ½"	5
113370	Sealer for ¾"	5



G.

Shipping Supplies

Bailing Wire

Special wire used to bail newspaper, etc. Corrugated for recycling.

Hi-Bulk Newsprint

Made from 100% recycled paper. Inexpensive newsprint paper is the economical and ecological choice for void fill applications.

Tape Dispenser

Carton seals quickly, efficiently and in one smooth operation. Engineered for long wear and ease of use.

Heavy Duty Poly Tape

Use this extra-strength poly tape for heavy cartons or packages. Ensures additional holding power for overweight items. Self-adhesive ... goes on fast with hand-held dispenser. Resists moisture, chemicals and oils.

SHIPPING INFORMATION:
3-5 Days, F.O.B. Cincinnati, OH



A. Bailing Wire

14' x 12 gauge. Other links and gauges available; call for pricing.

CAT. NO.	PER BUNDLE	NET PER BUNDLE
109646	125 wires	\$66.16

WARNING: Cancer and reproductive harm - www.P65Warnings.ca.gov



B. Bubble Wrap

All bubble wrap is cross perforated at 12". The rolls can be slit lengthwise by request.

CAT. NO.	DESCRIPTION	BUBBLE SIZE	NET EA.
113166	72" x 250'	1/2"	\$70.98
108966	48" x 375'	5/16"	\$61.44
103256	48" x 750'	3/16"	\$89.94
113176	12" x 175'	3/16"	\$18.53

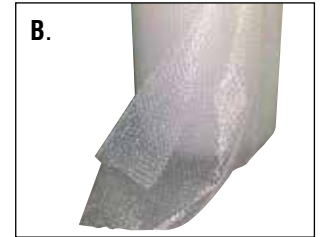

C. Hi-Bulk Newsprint

Pack and ship glassware, ceramics, etc.

CAT. NO.	DESCRIPTION	SIZE	NET EA.
107665	30# roll	18" x 1440'	\$11.23
107673	50# bundle/833 sheets	24" x 36"	\$57.75
107666	30# roll	30" x 1440'	\$18.70

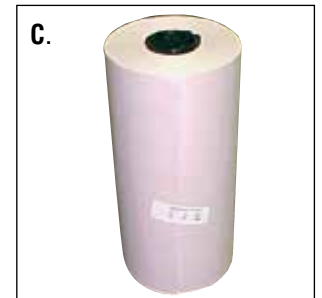

D. Kraft Wrapping Paper

Durable 40# paper is great for wrapping boxes, parts, books, and more.

CAT. NO.	DESCRIPTION	NET EA.
107615	24" x 900'	\$16.58
107620	36" x 900'	\$27.28
107627	48" x 900'	\$36.36



E. Tape Dispenser

Hand held for carton sealing.

CAT. NO.	DESCRIPTION	LBS.	NET EA.
104226	Deluxe 2" dispenser	1	\$24.86

Adjustable brake provides tape tension.



F. Heavy Duty Poly Tape

Extra strength poly tape for heavy cartons or packages.

CAT. NO.	ROLL COLOR	SIZE	MIL	NO. OF ROLLS PER CASE	LBS. PER CASE	NET EA. PER ROLL
110412	Clear	2" x 110 yds.	1.9	36	22	\$1.55
115554	Tan	2" x 110 yds.	1.9	36	22	\$1.60
110494	Clear	2" x 110 yds.	1.9	36	22	\$0.96
131669	Tan	2" x 110 yds.	1.9	36	22	\$4.25





Stretch Wrap

A. Extended Core Stretch Wrap Film

Core extends to create handles for easy hand-wrapping

CAT. NO.	SIZE	GAUGE	ROLLS PER CASE
109152	20" x 1000'	80	4



B. Stretch Wrap Dispenser

Cushioned grips for comfort. Adjustable for 12", 15" or 18" film.

CAT. NO.	LBS.
113494	4



C. Stretch Wrap Film (not shown)

Reduce product damage. Keeps cartons and boxes together during shipping.

CAT. NO.	SIZE	GAUGE	NO. ROLLS PER CASE
109102	12" x 1500'	80	4
109105	15" x 1500'	80	4
109108	18" x 1500'	80	4

SHIPPING INFORMATION: 3-5 Days, F.O.B. Cincinnati, OH



Nelson Wrap Dispensers are lightweight and help to reduce fatigue and work-related strain and injury. They accommodate various shaped pallets, from the floor up to 8' high and are manufactured with a patented brake system to ensure a tighter wrap and less film waste. Self-oiling materials provide smooth, consistent action, while tension control allows for preferred stretch. Both regular and coreless dispensers can handle 11'-20' rolls of film.



Wrap Dispenser

- Lightweight, aluminum hand-held dispenser
- Achieves tighter wrapped pallets to reduce freight claims

Wrap Dispenser

CAT. NO.	LENGTH	LBS.
NWD-1	60"	3



Coreless Stretch Wrap Dispenser

- Lightweight, heavy-duty aluminum for faster wraps
- Saves on waste hauling and cleanup
- Ecological shipping
- Achieves tighter wrapped pallets to reduce freight claims

Coreless Models

CAT. NO.	SIZE	LENGTH	LBS.
NWD-1HC	3"	60"	5
NWD-2HC	2"	60"	5

Boxed Size: 48" x 4.5" x 4.5"
Boxed weight = 6 lbs.



Ships UPS • Made in the USA

**SHIPPING INFORMATION:
1 Day, F.O.B. Bedford, PA**



Generating massive year-round energy savings while providing increased employee comfort make Hunter HVLS fans a perfect investment. Hunter fans are trusted in thousands of warehouses, factories, and other businesses worldwide.

Hunter HVLS fans are backed by a Limited Lifetime Warranty!

TITAN



FAN DIAMETER	INPUT POWER				MAX WATTS	AIR VOLUME	NOISE	WEIGHT
	480V/3PH	240V/3PH	240V/1PH	120V/1PH				
FT						CFM*	DB	LBS
14	X	X	X	-	650	122,215	<55	168
16	X	X	X	-	1075	183,096	<55	175
18	X	X	X	-	1010	205,449	<55	183
20	X	X	X	-	820	229,695	<55	190
24	X	X	X	-	1065	316,000	<55	214

ECO



FAN DIAMETER	INPUT POWER				MAX WATTS	AIR VOLUME	NOISE	WEIGHT
	480V/3PH	240V/3PH	240V/1PH	120V/1PH				
FT						CFM*	DB	LBS
8	X	X	X	-	455	46,175	<55	87
10	X	X	X	-	705	74,952	<55	97
12	X	X	X	-	675	91,043	<55	101
14	X	X	X	-	685	121,923	<55	128
16	X	X	X	-	795	154,024	<55	135
18	X	X	X	-	730	180,624	<55	138
20	X	X	X	-	820	216,255	<55	145
24	X	X	X	-	975	289,088	<55	159

XP



FAN DIAMETER	INPUT POWER				MAX WATTS	AIR VOLUME	NOISE	WEIGHT
	480V/3PH	240V/3PH	240V/1PH	120V/1PH				
FT						CFM*	DB	LBS
7	-	-	-	X	345	42,074	<55	100
8	-	-	-	X	360	45,787	<55	104
10	-	-	-	X	670	74,774	<55	108
12	-	-	-	X	730	91,901	<55	117
14	-	-	-	X	715	121,923	<55	121

JAN FAN

Jan Fan Industrial Air Circulators provide powerful, reliable airflow wherever it is needed most. Available in multiple sizes, colors, and mounting options, and backed by a full, five-year warranty!

MOUNTING OPTIONS

- C-Channel
- I-Beam
- Wall/Ceiling
- Articulating Arm*
- Pedestal
- Rugged Mobile
- Adapter Kit

*Not compatible with the 30" Jan Fan.

FAN DIAMETER	CFM	DB	Guard Blade Dia.	Power Cord Length
20"	4,250	60.2	24.6"	18'
24"	6,210	64	30.6"	18'
30"	7,710	70.9	36.6"	18'

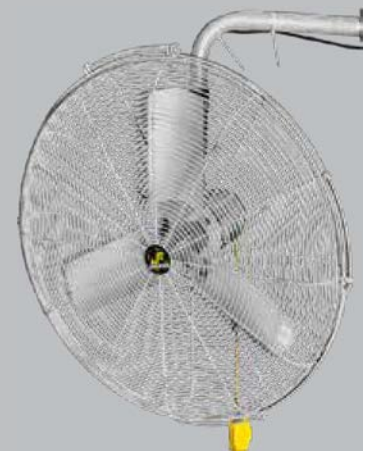
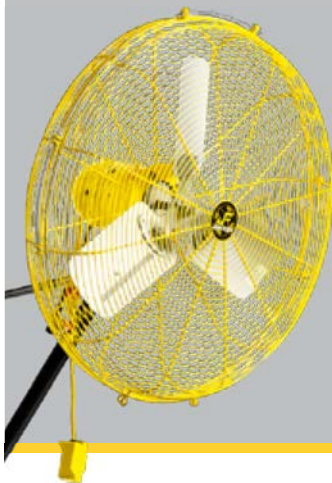

A. High Velocity Pedestal Fan

- 3-variable speed settings; heavy-duty all metal construction
- Telescoping adjustable height post; industrial high velocity motor
- OSHA-compliant safety grille; swivel head for directional airflow control

CAT. NO.	DESCRIPTION
MHD-30P	30" Blade, Direct, Pedestal Portable Fan
MAC-30POSC	Master 30" High Velocity Oscillating Pedestal Fan



B. Barrel Fan

- 2 Speeds; 4-blade, oversized fan
- Heavy-duty solid wheels; machined, built-in handle
- Powerful steel construction; low-noise, belt-drive operation
- OSHA-compliant safety guards; 10 ft. grounded power cord

CAT. NO.	DESCRIPTION
MHD-42-BDF-C	42" Blade, Belt, Floor Portable Fan
MHD-36-BDF-C	36" Blade, Belt, Floor Portable Fan
MHD-36D-C	36" Blade, Direct, Floor Portable Fan
MAC-48-BDF-C	48" Blade, Belt, Floor Portable Fan

C. Master Wall-Mount Fan

- 30" blade
- Drive type: Direct
- CFM: 6000/5000/5600
- Mount: Portable



CAT. NO.	DESCRIPTION
MHD-30W	30" High Velocity Wall Mount Fan
MAC-30WOSC	30" High Velocity Oscillating Wall Mount Fan

SHIPPING INFORMATION: 3-5 Days
F.O.B. Sauk Rapids, MN or Tullytown, PA

D. Big Dog

- Extremely quiet operations, at even the highest speeds, allowing for easy conversation and more comfortable working conditions
- Durable fiberglass air deflectors for adjusting airflow
- Fits conveniently in corridors and between sprinklers
- Specially designed cable, pole and wall mounts available for proper placement to deliver maximum airflow
- Can be used with variable speed drive for smooth speed adjustment requiring as little as 300 watts of power, leading to best in class energy efficiency of 40 cfm/watt
- Single phase model available by special order
- 2-year warranty

CAT. NO.	DESCRIPTION
BD72-208460-3	72" Ceiling Hung Circulation Fan w/Directional Louvers, 208-460V, 3 Phase



E. VersaKool Deep Guard Circulation Fan

- Deep guard design for unmatched performance, low noise levels and safety without sacrificing airflow
- Matched high quality motors and blades for maximum efficiency
- Powder coated steel guards for increased durability and corrosion resistance
- Hot dipped galvanized guards on VK12-GA and VK20-GA models for even greater rust protection
- Powder coated steel mounting bracket and power cord included
- Wide variety of mounting options available for flexible and easy installation
- Variable speed controls available
- Mistting kits available for even greater cooling
- 2-year warranty; made in the USA

CAT. NO.	DESCRIPTION
VK36	Fan Circulation 36" VersaKool 1Ph
VK36-3	Fan Circulation 36" VersaKool 3Ph



F. WayKool High Velocity Portable Evaporative Cooler

- 27 mph, reaches 70' from fan
- Reduces the temperature by up to 30° F*
- Unique oscillating outlet covers an area up to 4700 square feet
- Automatic low water shut off eliminates pump damage
- 24 gallon reservoir for up to 6 hours of cooling
- Garden hose connection for continuous use
- 2-year warranty

CAT. NO.	DESCRIPTION
WC-1HPMFA	White Portable Evaporative Cooler 1HP
WC-1HPMFAOSC	White Portable Evaporative Cooler 1HP Oscillating
WCG-1HPMFA	Grey Portable Evaporative Cooler 1HP
WCG-1HPMFAOSC	Grey Portable Evaporative Cooler 1 HP Oscillating



SHIPPING INFORMATION D. E. & F.
3-5 Days, F.O.B. Sauk Rapids, MN or Tullytown, PA

Industrial Fans

Heavy-duty pull chain switch. 12' - 3 conductor SJT type cord. Coated steel blade. Meets OSHA standards. UL Listed. One-year warranty.

Industrial Floor Fans

Fan head rotates 360° to deliver air flow to any spot in the room. 10' long, 3 conductor SJT cord. Meets OSHA standards. UL Listed. One-year warranty.

Workstation Fans

Work station mounts with one bolt or lag screw. Fan head rotates 360° horizontally and vertically. 10' long, 3 conductor SJT cord. UL Listed.

Belt-Drive Portable Blowers

Powder-coated 20-gauge steel housing. 10" hard rubber wheels, 12' long 3 conductor SJT type cord on 120V 1 phase models. UL Listed.

SHIPPING INFORMATION:
1 Week,
F.O.B. Louisville, KY

A. Industrial Fans — ¼ HP (not shown)

2-speed, 1 phase, 120V, totally enclosed, ball bearing, permanently lubricated split capacitor. Complete units with 24" or 30" diameter pedestal base.

CAT. NO.	TYPE	BLADE SIZE
ACU24-P	Stationary	24"
ACU30-P	Stationary	30"

WARNING: Cancer and reproductive harm - www.P65Warnings.ca.gov

B. Individual Fan Heads

CAT. NO.	TYPE	BLADE SIZE
IHP30H	Stationary	30"
IHP24H	Stationary	24"
ACH30	Stationary	30"
ACH24	Stationary	24"
ACH30-O	Oscillating	30"
ACH24-O	Oscillating	24"

WARNING: Cancer and reproductive harm - www.P65Warnings.ca.gov

B.



IHP30

C. Optional Fan Head Mounts

CAT. NO.	TYPE
ACM-P	Pedestal Mount
ACM-W	Wall Mount
ACM-I	I-beam Mount
ACM-C	Ceiling Mount
ACM-S	Suspension Mount
ACM-PM	Pole Mount
ACM-WK	Wheel Kit for Pedestal Mount

WARNING: Cancer and reproductive harm - www.P65Warnings.ca.gov

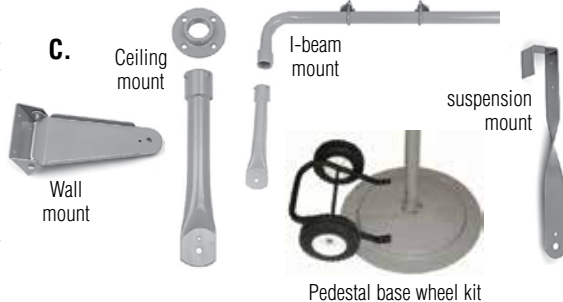

D. Industrial Floor Fans

3-speed, 1 phase, 120V sleeve bearing permanently lubricated motor.

CAT. NO.	TYPE	BLADE SIZE
F12-TE	Floor	12"
F18-TE	Floor	18"
F24-TE	Floor	24"
F18H-TE	Floor; High Stand	18"
F24H-TE	Floor; High Stand	24"

WARNING: Cancer and reproductive harm - www.P65Warnings.ca.gov

D.



E. Workstation Fans

3-speed, 1 phase, 120V sleeve bearing permanently lubricated motor.

CAT. NO.	TYPE	BLADE SIZE
U12-TE	Yolk Mount	12"
U18-TE	Yolk Mount	18"
U24-TE	Yolk Mount	24"

WARNING: Cancer and reproductive harm - www.P65Warnings.ca.gov

E.



F. Belt-Drive Portable Blowers

1-speed, permanently lubricated ball bearing motor.

CAT. NO.	TYPE	BLADE SIZE
PB36-B	Stationary	36"
PBS36-B	Swivel	36"
PB42-B	Stationary	42"
PBS42-B	Swivel	42"
PB48-B	Stationary	48"
PBS48-B	Swivel	48"

Note: Direct-drive blowers are available.

WARNING: Cancer and reproductive harm - www.P65Warnings.ca.gov



F.

AIR HAS EVOLVED.

Since developing the first HVLS prototype in 1998, MacroAir continues to serve as the “engineers of air™” through a commitment to innovation and design of the most durable and cost-effective commercial ceiling fans on the market.



A. AirVolution-D Model 370

CAT. NO.	DIAMETER	FORWARD DISPLACEMENT	MAX POWER USAGE	INDUSTRIAL SPACING
MA06XS3706	6'	19,000 CFM	110 W	28'
MA08XS3706	8'	38,000 CFM	270 W	36'
MA10XS3706	10'	47,000 CFM	190 W	40'
MA12XS3706	12'	54,000 CFM	140 W	48'

WARNING: Cancer and reproductive harm - www.P65Warnings.ca.gov



B. AirVolution-D Model 550

CAT. NO.	DIAMETER	FORWARD DISPLACEMENT	MAX POWER USAGE	INDUSTRIAL SPACING
MA08XL5506	8'	53,000 CFM	730 W	60'
MA10XL5506	10'	84,000 CFM	850 W	65'
MA12XL5506	12'	106,000 CFM	920 W	70'
MA14XL5506	14'	132,000 CFM	890 W	80'
MA16XL5506	16'	158,000 CFM	1070 W	90'
MA18XL5506	18'	181,000 CFM	900 W	95'

WARNING: Cancer and reproductive harm - www.P65Warnings.ca.gov



C. AirVolution-D Model 780

CAT. NO.	DIAMETER	FORWARD DISPLACEMENT	MAX POWER USAGE	INDUSTRIAL SPACING
MA20XL7806	20'	250,000 CFM	1180 W	105'
MA24XL7806	24'	346,000 CFM	1550 W	115'

WARNING: Cancer and reproductive harm - www.P65Warnings.ca.gov



D. AirVolution-D3

CAT. NO.	DIAMETER	FORWARD DISPLACEMENT	MAX POWER USAGE	INDUSTRIAL SPACING
MX10XL4303	10'	43,000 CFM	480W	55'
MA12XL4303	12'	84,000 CFM	510 W	60'
MA14XL4303	14'	117,000 CFM	590 W	70'
MA16XL4303	16'	125,000 CFM	430 W	75'
MA18XL4303	18'	166,000 CFM	610 W	80'
MA20XL4303	20'	211,000 CFM	780 W	90'
MA24XL4303	24'	248,000 CFM	810 W	95'

WARNING: Cancer and reproductive harm - www.P65Warnings.ca.gov

X, Y, Z Series

Looking for versatility, a true workhorse for the harshest industrial environments, or the ultimate utility fan? Then this series is for you. All use reliable gearbox-driven power units that provide huge airflow at a great value. Silent operation and sleek design features make these an excellent choice for even the chicest of spaces.

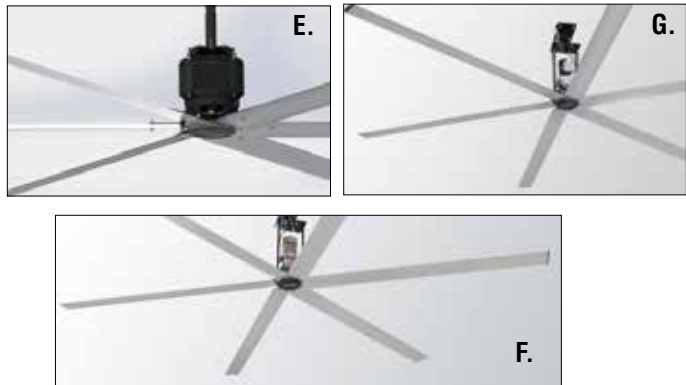

E. X Series

CAT. NO.	DESCRIPTION
MX00-0085-MA-08	8' Diameter
MX00-0085-MA-10	10' Diameter
MX00-0085-MA-12	12' Diameter
MX00-0085-MA-14	14' Diameter
MX00-0085-MA-16	16' Diameter
MX00-0085-MA-18	18' Diameter
MX00-0185-MA-20	20' Diameter
MX00-0185-MA-24	24' Diameter

F. Y Series

CAT. NO.	DESCRIPTION
MY08-0100-MA	8' Diameter
MY010-0100-MA	10' Diameter
MY12-0100-MA	12' Diameter
MY14-0100-MA	14' Diameter
MY16-0100-MA	16' Diameter
MY18-0100-MA	18' Diameter
MY20-0100-MA	20' Diameter
MY24-0100-MA	24' Diameter

G. Z Series

CAT. NO.	DESCRIPTION
MZ08-0100-MA	8' Diameter
MZ010-0100-MA	10' Diameter
MZ12-0100-MA	12' Diameter
MZ14-0100-MA	14' Diameter
MZ16-0100-MA	16' Diameter
MZ18-0100-MA	18' Diameter
MZ20-0100-MA	20' Diameter
MZ24-0100-MA	24' Diameter

WARNING: Cancer and reproductive harm - www.P65Warnings.ca.gov



Direct-Drive Motor



- Eliminates Gearbox
- Zero Maintenance

Cooling



Gentle Breeze Lowers Effective Temp. 8 °F

Heating



Bring Warm Air Down by Running in Reverse

Warranty



- Best in Industry
- 50,000 Hours

MacroAir
engineers of air™

Inventors of HVLS

Call your Crown Rep today to begin saving up to 90% on your lighting energy!



Green Light National is a leading Energy Services company specializing in ROI prioritized lighting upgrades and retrofits.

Green Light National will audit your current lighting and provide a proposal for the most cost effective LED solution for your business. Call your Crown Representative to learn more.

Green Light National specializes in LED lighting solutions for:

- Warehouse





Green Light National is a leading Energy Services company specializing in ROI prioritized lighting upgrades and retrofits.

Green Light National will audit your current lighting and provide a proposal for the most cost effective LED solution for your business. Call your Crown Representative to learn more.

Green Light National specializes in LED lighting solutions for:

- Office



- Roadway



- Building Exterior



Call your Crown Rep today to begin saving up to 90% on your lighting energy!

A-WALL™ BUILDING SYSTEMS

BY WARWICK PRODUCTS

The Flexible Alternative to Permanent Construction

A-WALL modular systems are installed faster and are more flexible than permanent construction. A-WALL can be disassembled, relocated or reconfigured as your needs change.

Additional benefits include....

- Quiet, Fire-Safe Construction
- Prefinished Panels - No Taping, Sanding or Painting
- Factory-Installed Receptacles, Switches and Data Boxes
- Significant Tax Savings
- Simple Assembly Using Common Hand Tools



Two-Story Building

Single-Story Buildings



Lab on Pre-Engineered Mezzanine



CMM Room



Warehouse Breakroom



Forkliftable Office



Modular Cleanroom

- Plant Offices
- Cleanrooms
- CMM Rooms
- Lunch Rooms
- Laboratories
- Equipment Enclosures
- Modular Office Walls
- Plant Partitions

Pre-Engineered In-Plant Buildings

Fast, Flexible, Affordable Construction



Freestanding Partition Walls

Create Controlled Environments

A-WALL environmental rooms create the conditions you require to meet today's strict manufacturing standards. Whether you need a cleanroom to improve process quality or meet a regulatory standard, an isolation room to segregate a "dirty" process from the rest of your facility or a temperature controlled CMM room, A-WALL offers a cost-effective solution.

Build Greener with A-WALL

A-WALL panels, connecting components, wood doors and windows are manufactured using partially recycled materials. Ultimately, the entire wall system can be recycled. Unlike conventional construction, A-WALL is easily disassembled, relocated and re-used, which reduces demand for raw materials, minimizes waste sent to landfills and saves energy.

A-WALL is faster than conventional construction.

Everything is pre-engineered. Wiring and windows are factory-installed in durable, prefinished panels for fast assembly. This means less disruption to your business and projects that are completed on schedule.

A-WALL changes with your requirements.

Pre-engineered A-WALL panels are interchangeable and 100% reusable. Your building can be expanded, rearranged or relocated to a new area or facility. You can't do that with stud and drywall.

Free site surveys, design assistance and estimates.

When you need to enclose personnel, a process or products, compare A-WALL to the cost of permanent construction. Your local A-WALL dealer, supported by factory engineers and talented installers, is prepared to assist you with your project from conception to completion.

One-Stop Shop

Factory Installation



Custom Cabinetry



Carpet Tiles



Sound-Dampening Panels



Guard Rails





Industrial Steel Work Platforms (Mezzanines)

Create space by building up, not out!

- Designed and manufactured to your specification requirements
- Designed for easy, fast assembly
- Specially engineered steel components quickly bolt together to form a strong and secure unitized structure
- Heavy-duty 5" x 5" x 3/16" thick columns are a standard minimum (larger sizes available), along with 12" x 12" x 3/4" thick base plates, providing rigid support while eliminating obstructive bracing



Available with Wildeck® Pallet Access Gates and Safety Gates

Decking Options

Multiple decking options exist to ensure your Wildeck® mezzanine is able to perform under your application requirements.

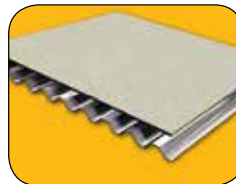

Roof Deck & Resin Board

Most economical system. Satisfactory for most mezzanine usage.

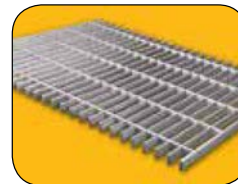

Bar Grating

Open design for ventilation and/or fire regulations; enables light to pass through.

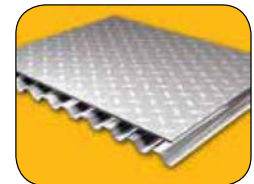

Roof Deck & Floor Plate

Ideal where local loads could be abusive or where non-combustibility is required.

Framing Options

Five structural framing options are available to meet your specific load and application requirements. Special framing options exist for seismic regions. Displayed by smaller applications (left) to larger applications (right). Capacities vary by span and framing option specified.



Bolted C-Section

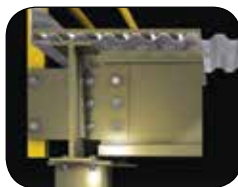

Beam & C-Section



Beam & Beam



Beam & Bar Joist



Truss Girder & Bar Joist

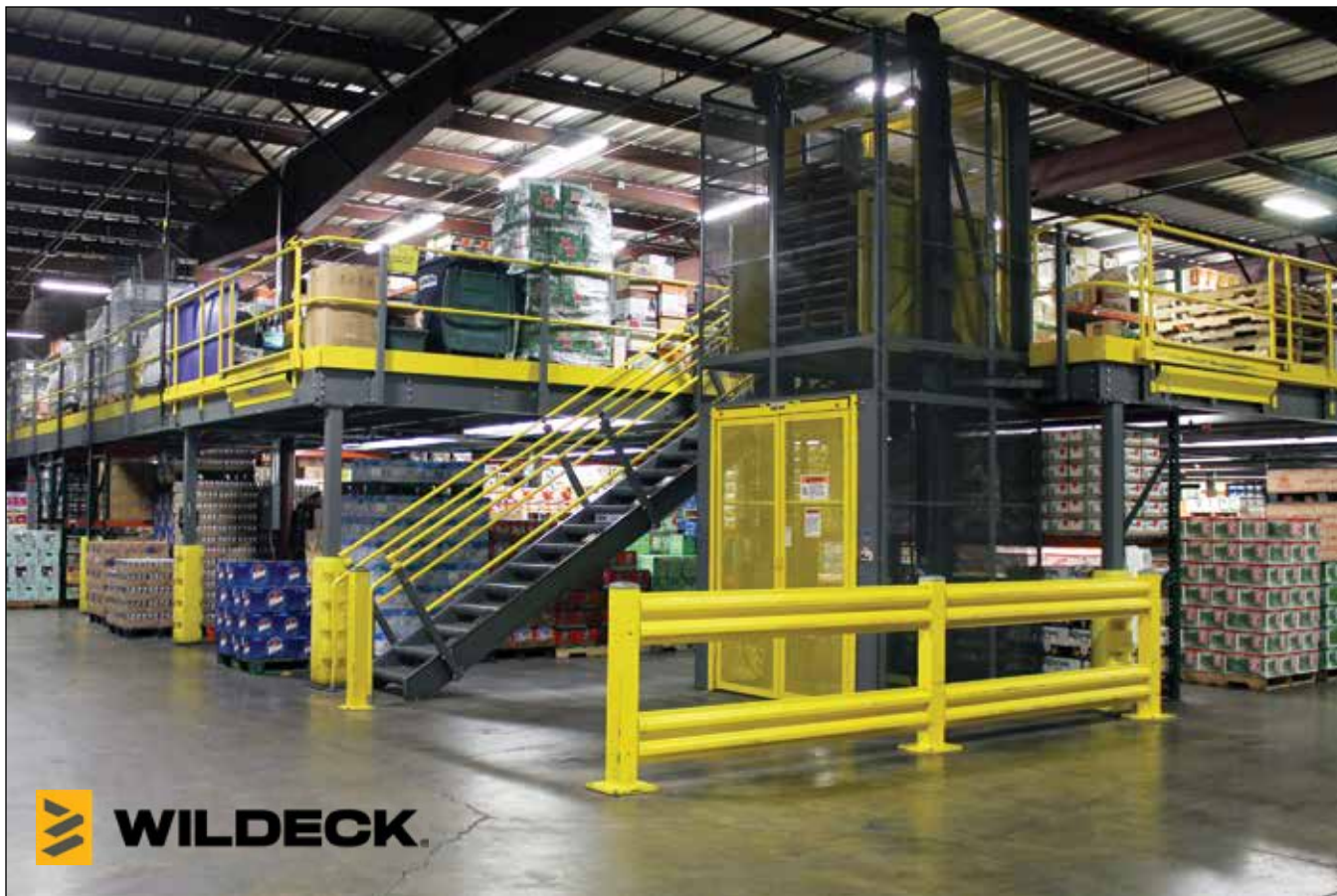

CREATE SPACE BY BUILDING UP, NOT OUT

Wildeck® structural mezzanine platforms are your best solution to fully utilize existing overhead space to operate more efficiently and profitably.

You can gain valuable space for:

- Work Stations
- Conveyors
- In-plant Offices
- Manufacturing
- Material Storage
- Distribution
- Specialty use

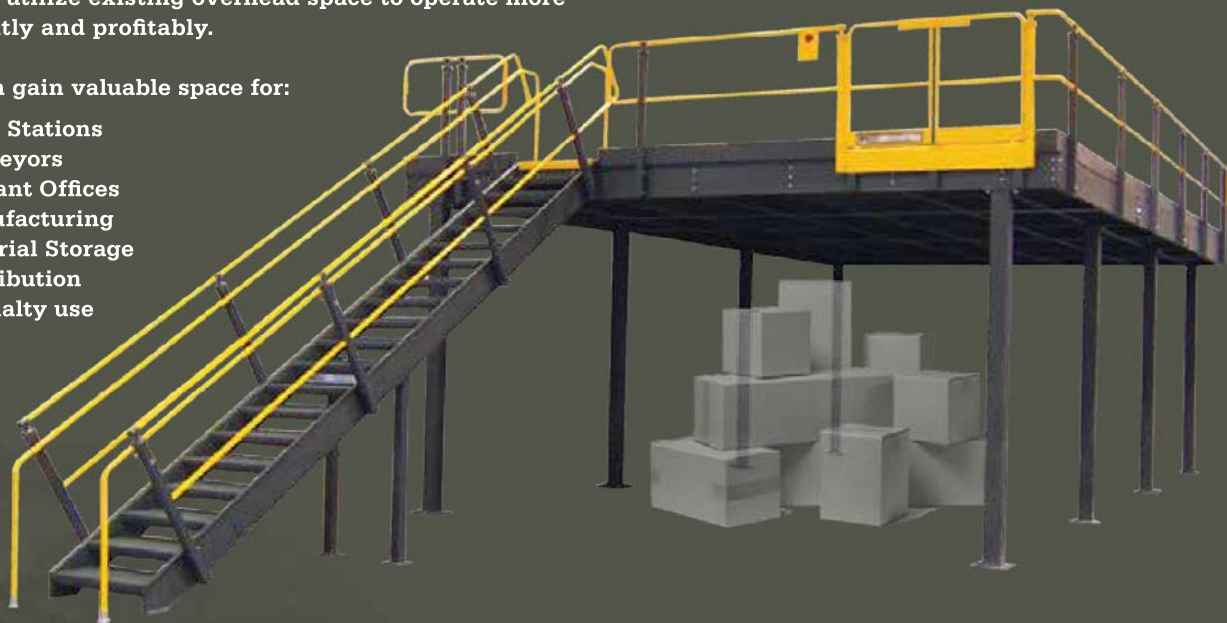



Pivot Gate



Double-Drop Gate



Overhead Gate



Impact Gate



Swing Gate



Slide Gate



Pallet Drop Zone Gate



Finger Gate



Gate Alarms



Increase safety and achieve the operational efficiency you desire from your system. Wildeck designs and manufactures a wide range of access and safety gates that can be easily integrated with your mezzanine.

Complete vertical lifting solutions



- Safely transport materials between two or more levels
- Install in new or existing buildings
- Customized to your application
- Hydraulic, mechanical, package handling, custom vertical lifts
- Multi-level, fully automatic systems
- Capacities from 10 lbs. to 100,000 lbs.
- Unlimited vertical rise
- Carriage sizes up to 30 x 30 ft.
- Guaranteed code approval
- Over 16,000 proven applications

Call Crown Lift Trucks today for a quote.

PFlow Industries has the engineering capabilities, experience and technical know-how to solve a myriad of vertical lifting problems. We have built large load work platforms, over and under equipment for assembly lines, hopper transfer systems and much more. At Pflow, we know each vertical lift application is unique. We carefully analyze your needs, cover all design & construction issues, provide complete code-approved engineered drawings and deliver unmatched, ongoing service support. Experienced engineers will design a vertical lift tailored to your needs. The focus has always been on safety and advanced technology — and creating solutions for specific vertical material handling problems.



PFlow
Industries, Inc.

Vertical Reciprocating Conveyors

Vertical Reciprocating Conveyors (VRCs) provide fast, efficient, convenient and safe access to/from mezzanines and between levels in multiple-story buildings. They can be installed for through-floor, interior or exterior applications.

The principal components of VRCs include guide columns, carriage and a mechanical or hydraulic actuating mechanism.

SHIPPING INFORMATION:
8 Weeks, F.O.B. Milwaukee, WI

offers a unique concept of structural platforms as the foundation for integrated material handling technology. With experience and expert engineering, they will provide you solutions on unique custom designs and standard platform applications.

Using different types of construction, they offer design flexibility to meet your exact specifications. Their platforms can be designed for extreme load capacities and wide clear spans.

Available deck options, include Resindex (coated and uncoated), bar grate, concrete ready, diamond plate and wood.

Heartland Engineered Products can also provide accessories for your existing facility and other applications. Their platform accessories include, Stairways, Landings, Catwalks, Steep Assent Ladders, Caged Ladders, Crossovers, Slide Gates, Swing Gates, and Handrail.

Heartland Engineered Products stairways are fabricated to be rugged and long lasting. Treads are furnished in black diamond plate up to 48" wide with bar grating available.

One piece stringers are constructed of hot-rolled channel, with heavy duty railing. The brackets for base and landing mounts, as well as all hardware is supplied.

Standard handrail and stringers are yellow, with other colors available.

Stairways are shipped unassembled for the most economical shipping cost but no field welding is required. We also offer options such as vertical pickets, 4" sphere guarding and top support columns for a free-standing stairway.

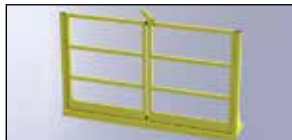



Steel Rolling Ladder

- 450 lb. rated capacity
- Perforated or serrated tread
- Ships unassembled
- 1¹/₁₆" tubular steel construction
- Powder coat gray finish
- Springloaded casters
- 2-5 step models
- Step lock 6-16 step models
- Complies with applicable OSHA & ANSI standards

Mobile Foldaway Step Stand

Combines the features and benefits of a rolling ladder and step stand.

- Easily folds for storage
- 10" deep top platform
- 7" deep steps
- 300 lb. rated capacity
- Perforated tread
- Ships knocked down
- 1¹/₁₆" tubular steel construction
- Powder coat gray finish
- Complies with applicable OSHA & ANSI standards

Tilt & Roll Ladder

- 450 lb. rated capacity
- Perforated or serrated tread
- Ships unassembled
- 1¹/₁₆" tubular steel construction
- Powder coat gray finish
- Complies with applicable OSHA & ANSI standards

SHIPPING INFORMATION:
7 Days, F.O.B. Pittsburgh, PA

Steel Rolling Ladder

PERFORATED CAT. NO.	SERRATED CAT. NO.	NO. OF STEPS	STEP WIDTH	PLATFORM HEIGHT	OVERALL HEIGHT	PLATFORM W X L	BASE W X D
WITHOUT HANDRAILS							
KDSR002166	KDSR002162	2	16"	20"	20"	16" x 10"	21" x 21"
KDSR002246	KDSR002242	2	24"	20"	20"	24" x 10"	28" x 21"
KDSR003166	KDSR003162	3	16"	30"	30"	16" x 10"	24" x 28"
KDSR003246	KDSR003242	3	24"	30"	30"	24" x 10"	30" x 28"
KDSR004166	KDSR004162	4	16"	40"	40"	16" x 10"	24" x 35"
KDSR004246	KDSR004242	4	24"	40"	40"	24" x 10"	30" x 35"

WITH HANDRAILS							
KDSR102166	KDSR102162	2	16"	20"	56"	16" x 10"	21" x 21"
KDSR102246	KDSR102242	2	24"	20"	56"	24" x 10"	28" x 21"
KDSR103166	KDSR103162	3	16"	30"	66"	16" x 10"	24" x 28"
KDSR103246	KDSR103242	3	24"	30"	66"	24" x 10"	30" x 28"
KDSR104166	KDSR104162	4	16"	40"	76"	16" x 10"	24" x 35"
KDSR104246	KDSR104242	4	24"	40"	76"	24" x 10"	30" x 35"
KDSR105166	KDSR105162	5	16"	50"	86"	16" x 10"	24" x 42"
KDSR105246	KDSR105242	5	24"	50"	86"	24" x 10"	30" x 42"
KDSR106166	KDSR106162	6	16"	60"	96"	16" x 10"	27" x 50"
KDSR106246	KDSR106242	6	24"	60"	96"	24" x 10"	35" x 50"
KDSR107166	KDSR107162	7	16"	70"	106"	16" x 10"	27" x 57"
KDSR107246	KDSR107242	7	24"	70"	106"	24" x 10"	35" x 57"
KDSR108246	KDSR108242	8	24"	80"	116"	24" x 10"	35" x 64"
KDSR109246	KDSR109242	9	24"	90"	126"	24" x 10"	35" x 69"
KDSR110246	KDSR110242	10	24"	100"	136"	24" x 10"	35" x 76"
KDSR111246	KDSR111242	11	24"	110"	146"	24" x 10"	35" x 83"
KDSR112246	KDSR112242	12	24"	120"	156"	24" x 10"	35" x 90"
KDSR113246	KDSR113242	13	24"	130"	166"	24" x 10"	40" x 96"
KDSR114246	KDSR114242	14	24"	140"	176"	24" x 10"	40" x 103"
KDSR115246	KDSR115242	15	24"	150"	186"	24" x 10"	40" x 110"

Mobile Foldaway Step Stand

CAT. NO.	NO. OF STEPS	STEP WIDTH	PLATFORM HEIGHT	OVERALL HEIGHT	PLATFORM W X L	BASE W X D
KDMF102166	2	16"	20"	44"	16" x 10"	21" x 20"
KDMF103166	3	16"	30"	54"	16" x 10"	21" x 27"
KDMF104166	4	16"	40"	64"	16" x 10"	21" x 34"

Tilt & Roll Ladder

PERFORATED CAT. NO.	SERRATED CAT. NO.	NO. OF STEPS	STEP WIDTH	PLATFORM HEIGHT	OVERALL HEIGHT	PLATFORM W X L	BASE W X D
KDTF102166	KDTF102162	2	16"	20"	56"	16" x 10"	23" x 23"
KDTF102246	KDTF102242	2	24"	20"	56"	24" x 10"	31" x 23"
KDTF103166	KDTF103162	3	16"	30"	66"	16" x 10"	24" x 30"
KDTF103246	KDTF103242	3	24"	30"	66"	24" x 10"	31" x 30"
KDTF104166	KDTF104162	4	16"	40"	76"	16" x 10"	24" x 37"
KDTF104246	KDTF104242	4	24"	40"	76"	24" x 10"	31" x 37"
KDTF105166	KDTF105162	5	16"	50"	86"	16" x 10"	24" x 44"
KDTF105246	KDTF105242	5	24"	50"	86"	24" x 10"	31" x 44"
KDTF106166	KDTF106162	6	16"	60"	96"	16" x 10"	27" x 52"
KDTF106246	KDTF106242	6	24"	60"	96"	24" x 10"	35" x 52"
KDTF107166	KDTF107162	7	16"	70"	106"	16" x 10"	31" x 59"
KDTF107246	KDTF107242	7	24"	70"	106"	24" x 10"	37" x 59"



Safety Angle Rolling Ladder

PERFORATED CAT. NO.	SERRATED CAT. NO.	NO. OF STEPS	STEP WIDTH	PLATFORM HEIGHT	OVERALL HEIGHT	PLATFORM W X L	BASE W X D
KDEC103166	KDEC103162	3	16"	30"	66"	16" x 17"	27" x 41"
KDEC103246	KDEC103242	3	24"	30"	66"	24" x 17"	35" x 41"
KDEC104166	KDEC104162	4	16"	40"	76"	16" x 17"	27" x 49"
KDEC104246	KDEC104242	4	24"	40"	76"	24" x 17"	35" x 49"
KDEC105166	KDEC105162	5	16"	50"	86"	16" x 17"	27" x 58"
KDEC105246	KDEC105242	5	24"	50"	86"	24" x 17"	35" x 58"
KDEC106166	KDEC106162	6	16"	60"	96"	16" x 17"	27" x 66"
KDEC106246	KDEC106242	6	24"	60"	96"	24" x 17"	35" x 66"
KDEC107166	KDEC107162	7	16"	70"	106"	16" x 17"	27" x 74"
KDEC107246	KDEC107242	7	24"	70"	106"	24" x 17"	35" x 74"
KDEC108246	KDEC108242	8	24"	80"	116"	24" x 17"	35" x 82"
KDEC109246	KDEC109242	9	24"	90"	126"	24" x 17"	35" x 91"
KDEC110246	KDEC110242	10	24"	100"	136"	24" x 17"	35" x 99"
KDEC111246	KDEC111242	11	24"	110"	146"	24" x 17"	35" x 107"
KDEC112246	KDEC112242	12	24"	120"	156"	24" x 17"	35" x 116"
KDEC113246	KDEC113242	13	24"	130"	166"	24" x 17"	40" x 124"
KDEC114246	KDEC114242	14	24"	140"	176"	24" x 17"	40" x 132"
KDEC115246	KDEC115242	15	24"	150"	186"	24" x 17"	40" x 141"



SHIPPING INFORMATION:
7 Business Days,
F.O.B. Pittsburgh, PA

Perforated U-Design Configurable Crossover - 50° Incline Steps

CAT. NO.	LADDER QTY.	NO. OF STEPS	STEP WIDTH	STEP DEPTH	PLATFORM HEIGHT	OVERALL HEIGHT	BASE WIDTH	VERTICAL CLEARANCE	SPAN MODEL	SPAN QT.	SPAN LENGTH
UCL5003246	2	3	24"	10"	30"	72"	26.5"	28"	UCB20246	1	20"
UCL5003246	2	3	24"	10"	30"	72"	26.5"	28"	UCB30246	1	30"
UCL5004246	2	4	24"	10"	40"	82"	26.5"	38"	UCB20246	1	20"
UCL5004246	2	4	24"	10"	40"	82"	26.5"	38"	UCB30246	1	30"
UCL5005246	2	5	24"	10"	50"	92"	26.5"	48"	UCB20246	1	20"
UCL5005246	2	5	24"	10"	50"	92"	26.5"	48"	UCB30246	1	30"
UCL5006246	2	6	24"	10"	60"	102"	26.5"	58"	UCB20246	1	20"
UCL5006246	2	6	24"	10"	60"	102"	26.5"	58"	UCB30246	1	30"

*Each U-shaped crossover design consists of 2 ladders and 1 span length.

*75° incline, 90° incline, & serrated step options also available.

SHIPPING INFORMATION:
1-2 Weeks,
F.O.B. Pittsburgh, PA



Safety Angle Rolling Ladder

- 17" deep top platform
- 50° safety angle incline
- 450 lb. rated capacity
- Perforated or serrated tread
- Ships unassembled
- 1½" tubular steel rails
- 1" x 2" reinforced back & bottom frame
- 8.5" deep steps, 10" deep 1st step
- Powder coat gray finish
- Step Lock all models
- Complies with applicable OSHA & ANSI standards

U-Design Configurable Crossovers

- 1" x 2" rectangular tube construction
- Modular, configurable components
- Standard perforated or Grip-Strut slip-resistant tread design
- 24" step width
- Custom crossover sizes available
- Powder coated yellow finish
- 1000 lb. rated capacity



Invest in the Possibilities

Over **1900** companies | **488** unique applications | **1** revolutionary solution

The Wave® has excelled in a variety of applications - from stocking shelves in retail stores to collecting parts for the assembly of goods in the manufacturing process, and everything in between. The Wave Work Assist Vehicle is smooth enough to handle historical artifacts in the Smithsonian Institute, yet rugged enough to be used in the welding process of large scale ships. The Wave has even been noted for its quiet operation at the Mormon Tabernacle.



Challenge yourself to **safely** increase your
productivity by employing the **Wave**.

Faster. Safer. Smarter.



WAV 60 Series

◀ USE THIS
INSTEAD
OF THIS ▶



It all adds up.

1 Number of free hands **OSHA** requires someone to have when moving up or down a ladder.

2 Number of people it takes to perform dozens of tasks that **can be completed by just one person using a Wave.**

5 mph Speed of the **Wave**. That's almost **twice as fast** as the average walking speed.

14 months Average time it takes for the **Wave to pay for itself.**

15 Average number of **days lost** from work per person **due to a ladder injury.**

50 Percent **increase in efficiency** reported by existing **Wave users.**

The **Wave Work Assist Vehicle** can **improve your bottom line** by replacing your labor-intensive manual methods of material handling with a safer, faster solution. See for yourself just how fast the **Wave can pay for itself.**

In independent time studies, the **Wave proved to increase productivity** while decreasing risk of injury and accidents. Because with the Wave, there's no wobbling while climbing up and down ladders with heavy loads. It's smooth *wavelike* motion allows an operator and a load to navigate the tightest aisles and travel safely at working heights up to 17 feet.

Invest in the Wave®.

You can't afford not to.

to learn more visit crown.com

Genie®

QUALITY BY DESIGN

From the first compressed air material lift in 1966 that started an industry, to the modern machines coming out of their factories today, Genie has been the leading name in mobile elevating work platforms (MEWPs). For more than 55 years, Genie has been committed to customers, focusing on high-quality, well-designed solutions and expert support for a superior end-to-end experience.

PORTABLE MATERIAL LIFTS
AERIAL WORK PLATFORMS
ARTICULATING BOOMS
TELESCOPIC BOOMS
SELF-PROPELLED SCISSOR LIFTS
TRAILER MOUNTED BOOMS
TELEHANDLERS



Contact your local Crown Lift Truck Representative for more information.

© 2023 Terex Corporation. Genie is a trademark of Terex Corporation or its subsidiaries.

Genie® GS™ Scissor Lifts

Genie® GS™ slab scissor lifts are exceptionally mobile, letting operators easily maneuver around tight indoor and outdoor worksites with firm, level surfaces. Characterized by low noise levels, they provide excellent capacity and large platform workspace.

GS-2632

Ideal for maneuvering in tight spaces, the quiet, zero emission electric Genie® GS™-2632 slab scissor lift is excellent for indoor and outdoor construction, maintenance and installation applications on firm, level surfaces.

Max Working Height (indoor)	32 ft 1 in
Max Working Height (outdoor)	25 ft
Capacity	500 lb
Machine Width	2 ft 8 in
Machine Length	8 ft

GS-3232

The Genie® GS™-3232 E-Drive slab scissor lift is an electric model ideal for operation in emission and sound-sensitive indoor and outdoor jobsites where space is limited. The standard, state-of-the-art Genie AC electric E-Drive system offers unmatched efficiency and runtime on installation, maintenance and construction jobs, especially when a significant amount of driving is required.

Max Working Height (indoor)	38 ft 1 in
Max Working Height (outdoor)	24 ft
Capacity	500 lb
Machine Width	2 ft 8.2 in
Machine Length	8 ft

GS-1432m

Designed for low-level access on sensitive flooring and space restricted applications, the Genie® GS™-1432m E-Drive scissor lift delivers quality and durability while improving total cost of ownership and productivity.

Max Working Height (indoor)	20 ft 1 in
Max Working Height (outdoor)	18 ft
Capacity	500 lb
Machine Width	32 ft
Machine Length	4 ft 7 in

GS-3246

Compact dimensions and zero inside turning radius make the Genie® GS™-3246 E-Drive slab scissor lift ideal for indoor and outdoor construction, maintenance, and installation tasks on level ground and in tight spaces. Boasting the state-of-the-art Genie AC electric E-Drive system, it offers unmatched efficiency and runtime when a significant amount of driving is required.

Max Working Height (indoor)	38 ft 1 in
Max Working Height (outdoor)	28 ft
Capacity	700 lb
Machine Width	3 ft 10 in
Machine Length	8 ft

GS-4046

Increase productivity in high-rise spaces with the Genie® GS™-4046 E-Drive slab scissor lift. With a compact footprint ideal for work in narrow aisles, it features the state-of-the-art Genie AC electric E-Drive system for unmatched performance and runtime in high indoor and outdoor jobsites that require a significant amount of driving on level ground.

Max Working Height (indoor)	45 ft 2 in
Max Working Height (outdoor)	29 ft
Capacity	770 lb
Machine Width	3 ft 10 in
Machine Length	8 ft 2 in

GS-2646

The Genie® GS™-2646 E-Drive slab scissor lift is suitable for work indoors and outdoors on firm, level surfaces where space is limited. Its state-of-the-art Genie AC electric E-Drive system offers unmatched efficiency and runtime on installation, maintenance and construction jobs where a significant amount of driving is required.

Max Working Height (indoor)	32 ft 1 in
Max Working Height (outdoor)	25 ft 8 in
Capacity	1000 lb
Machine Width	3 ft 10 in
Machine Length	8 ft



GS-1932 / GS-1932m

Productive performance in indoor and outdoor construction, maintenance and installation applications on firm, level surfaces, the Genie® GS™-1932 slab scissor lift maneuvers easily and precisely in tight spaces.

Max Working Height (indoor)	24 ft 2 in (GS-1932m) 25 ft 3 in (GS-1932)
Max Working Height (outdoor)	21 ft (GS-1932m) 20 ft 8 in (GS-1932)
Capacity	500 lb
Machine Width	2 ft 8 in (GS-1932m) 2 ft 8.2 in (GS-1932)
Machine Length	4 ft 7 in (GS-1932m) 6 ft (GS-1932)

GS-4655

The Genie® GS™-4655 E-Drive slab scissor lift is a robust and eco-friendly machine engineered with the state-of-the-art Genie AC electric E-Drive system, for unmatched performance and runtime in high indoor and outdoor jobsites requiring a significant amount of driving.

Max Working Height (indoor)	51 ft 9 in
Max Working Height (outdoor)	27 ft 6 in
Capacity	770 lb
Machine Width	4 ft 7 in
Machine Length	10 ft 2 in

Other lift heights and capacities available. All Genie equipment to be used on improved hard flat surfaces.



Genie® Boom and Vertical Mast Lifts

Both Genie® boom lifts and Runabout® lifts are designed to enhance productivity in the workplace. Each model offers a variety of options and accessories to customize the machine to match the application.

Z-30/20N RJ

The Genie® Z®-30/20N RJ articulating boom lift offers quiet, emission-free operation in the most sensitive work environments, and includes a rotating jib for 180° of horizontal rotation. Similar to the Z®-30/20N, when the machine must be driven significant distances.

Max Working Height	35 ft 2 in
Max Horizontal Reach	20 ft 6 in
Max Up and Over Clearance (riser extended)	12 ft 8 in
Platform Capacity	500 lb

Z-34/22N

The Genie® Z®-34/22N electric articulating boom lift offers quiet, emission-free operation in the most sensitive work environments, as a 48V DC machine.

Max Working Height	40 ft 6 in
Max Horizontal Reach	22 ft 3 in
Max Up and Over Clearance (riser extended)	15 ft 3 in
Platform Capacity	500 lb



Z-45 FE

Two machines in one, the Genie® Z®-45 FE hybrid articulating boom lift is the ideal, environment-friendly solution for increased efficiency and low cost of operation. In "all-electric" mode it offers a full workday of emissions-free run time on a single battery charge. In "hybrid" mode, it offers one week of run time with a single tank of diesel.

Max Working Height	51 ft 8 in
Max Horizontal Reach	22 ft 9 in
Max Up and Over Clearance (riser extended)	24 ft 7 in
Platform Capacity	660 lb



Z-45/25J DC

The Genie® Z®-45/25J DC electric articulating boom lift offer quiet, emission-free operation. With this Genie electric boom lift, operators can easily work close to buildings or around obstacles, and access overhead work from aisles and other congested areas.

Max Working Height	51 ft 9 in
Max Horizontal Reach	25 ft 1 in
Max Up and Over Clearance (riser extended)	23 ft 9 in
Platform Capacity	500 lb

GR-26J

The Genie® Runabout® GR-26J™ lift is a jib machine that offers outreach capability to get virtually any job done. A 140° rotating jib and 350° non-continuous hydraulic turntable allows for exceptional range of motion and precise positioning. These capabilities combined with the efficient electric drive motors and a low machine weight make the Genie Runabout GR-26J lift the solution for hard-to reach jobsite needs.

Max Working Height	31 ft 11 in
Capacity	440 lb
Stowed Height	6 ft 6 in
Machine Width	3 ft 3 in
Weight	5,842 lb

JLG® Lift Equipment

You need to go higher. Work faster. Do more. Check out the lift equipment from JLG that will take you to new heights, helping you conquer those challenges with confidence. From the latest access lifts to services, parts and technical support, JLG makes sure you have what you need to get the job done. JLG is a leading supplier of access equipment, including various man lifts, and mobile elevating work platforms (MEWP). A mobile elevating work platform can help you reach tasks at height with enhanced safety and greater productivity, whether you need to access work at 5 ft or 185 ft.

All your access equipment needs can be filled with our wide range of products. Explore our full product offering today.



1030P

Low-Level Access Lifts

For light maintenance and facility work, low-level access satisfies your need for a safe, efficient, and simple ladder alternative. JLG helps you get the job done with low-level access solutions that range from Push Arouds to the eco-friendly, non-powered EcoLifts™.

	Platform Height	Working Height	Width	Platform Capacity
EcoLift 50	4-ft 11-in	10-ft 11-in	2-ft 4-in	330-lb
EcoLift 70	7-ft 3-in	13-ft 3-in	2-ft 4-in	330-lb
830P	8-ft 2-in	14-ft 2-in	2-ft 6-in	440-lb
1030P	10-ft 2-in	16-ft 2-in	2-ft 6-in	550-lb



25AM

Vertical Lifts

When your maintenance or repair work requires overhead reach in tight spaces, you need vertical lift solutions that deliver full access with the productivity to finish those pressing tasks. Our range of push around vertical lifts are an efficient and productive way to tackle up and over work. They're also a safer, more efficient alternative to ladders, giving you a boost of confidence on the job.

	Platform Height	Working Height	Width	Platform Capacity
25AM	24-ft 10-in	31-ft	2-ft 6-in	350-lb
30AM	29-ft 7-in	35-ft 7-in	2-ft 5-in	300-lb
38AM	38-ft	44-ft	2-ft 5-in	300-lb

Contact your local Crown Lift Truck Representative for more information.

All JLG equipment is to be used on firm, level surfaces.



ES2632 Raised Front

ES Series Scissor Lifts

Experience the benefits of reduced charging time and longer runtime with the ES Series. Choose from a wide range of model options offering up to 1,200-lb capacity, with indoor-only and indoor/outdoor capabilities, and full proportional controls that come standard for ease of operation. Optional accessory packages enhance your productivity.

	Platform Height	Working Height	Width	Platform Capacity	Weight
ES1330L	13-ft	19-ft	2-ft 6-in	500-lb (indoor/outdoor)	1984-lb
ES1530L	15-ft	21-ft	2-ft 6-in	500-lb (indoor/outdoor)	1940-lb
ES1932	19-ft	25-ft	2-ft 8-in	507-lb (indoor/outdoor)	3450-lb
ES2632	25-ft 6-in	31-ft 6-in	2-ft 8-in	507-lb (indoor) / 275-lb (outdoor)	4400-lb
ES2646	26-ft	32-ft	3-ft 10-in	1200-lb (indoor/outdoor)	5295-lb
ES3246	32-ft	38-ft	3-ft 10-in	705-lb (indoor) / 507-lb (outdoor)	5620-lb
ES4046	39-ft 3-in	46-ft	3-ft 10-in	770-lb (indoor) / 550-lb (outdoor)	6230-lb



AE1932

All Electric Scissor Lift

The new industry benchmark—the DaVinci Series AE1932—is a fully electric scissor lift that has zero hydraulic components, which means you experience zero leaks. Its electric driveline components contribute to a 70% decrease in power consumption, enabling this machine to do more work while consuming less energy. The lower energy consumption also allows this lift to use a single, maintenance-free Lithium-Ion battery that lasts the life of the machine.

	Platform Height	Working Height	Width	Platform Capacity	Weight
AE1932	19-ft	25-ft	2-ft 8-in	606-lb (indoor/outdoor)	3510-lb



ERT2669

Electric Rough Terrain Scissor Lifts

Our family of JLG® electric powered rough terrain scissors offers four models ranging in platform heights from 26 ft to 47 ft. Each of these models is capable of driving at full height, ensuring this line provides the broadest range of machines to handle any application.

	Platform Height	Working Height	Width	Platform Capacity	Weight
ERT2669	26-ft 2-in	32-ft 2-in	5-ft 9-in	1500-lb	8250-lb
ERT3369	33-ft	39-ft	5-ft 9-in	1000-lb	9457-lb
ERT4069	40-ft 3-in	46-ft 3-in	5-ft 9-in	800-lb	10,558-lb
ERT4769	47-ft	53-ft	5-ft 9-in	800-lb	15,200-lb

Contact your local Crown Lift Truck Representative for more information.

All JLG equipment is to be used on firm, level surfaces.



EC600SJ

Electric Telescopic Boom Lifts

For challenging indoor and outdoor spaces where you have to tackle many angles with little impact, you need a machine that delivers optimal horizontal and vertical outreach. JLG telescopic boom lifts give you the height and capacity you need along with clean operation and excellent maneuverability. With zero emissions and low noise, these machines are ideal for situations that require the fewest environmental disruptions. Longer duty cycles keep productivity high from start to finish.

	Platform Height	Working Height	Width	Platform Capacity	Weight
EC600SJ	60-ft 3-in	66-ft 3-in	7-ft 11-in	500-lb	16710-lb
EC600SJP	60-ft 4-in	66-ft 4-in	7-ft 11-in	500-lb	17210-lb

Toucan Mast Boom Lifts

With the JLG Toucan® vertical mast lift, you can meet your overhead challenges head-on. Work up, over and around assembly lines, shelving, ductwork or partitions more easily and without interferences. These mast boom lifts feature thick rubber non-marking tires, clean and efficient electric power and 25% gradeability.

	Platform Height	Working Height	Width	Platform Capacity	Weight
20E	20-ft 3-in	26-ft 3-in	3-ft 3-in	500-lb	4875-lb
26E	26-ft 6-in	32-ft 6-in	3-ft 3-in	500-lb	6900-lb
32E	32-ft 3-in	38-ft 3-in	3-ft 9-in	500-lb	10140-lb



Toucan 26E



E400AJPN

Electric Articulating & Hybrid Boom Lifts

Today, more people are demanding environmentally friendly equipment. And more municipalities are requiring “green” building for new construction and renovations. The JLG line of electric boom lifts feature longer run time, greater uptime and higher productivity. These machines are specifically designed so you have fewer scheduled services, a quieter work area, less dependency on hydraulic oils and zero emissions.

	Platform Height	Working Height	Horizontal Outreach	Up and Over Height	Platform Capacity
H340AJ	33-ft 10-in	39-ft 10-in	19-ft 11-in	17-ft	500-lb
E300AJP	29-ft 5-in	35-ft 5-in	20-ft 1-in	13-ft 2-in	500-lb
E400AJPN	40-ft	46-ft	22-ft 5-in	21-ft 6-in	500-lb
E450AJ	45-ft	51-ft	23-ft 9-in	25-ft 3-in	500-lb

CROWN

Mobile Work Positioning Solutions

Scissor Lifts

Elevate comfort and productivity with Crown's hand pallet truck with scissor lift. Available with manual or electrically powered hydraulics, scissor lifts provide ergonomic advantages for raising and transporting open-bottom containers and skids.



PTH 50S
Capacity: 2,000 lbs.
Max Lift Height: 31.3 in.

Walkie Stackers

Designed with flexibility in mind, Crown stackers satisfy a wide range of applications with easy to use features to meet multiple needs. These include: stacking vertically on a rack system, positioning a portable work station at optimal height, simplifying maintenance tasks, shipping and receiving at ground level.



M 3200 Series
Capacity: 2,000 lbs.
Max Lift Height: 144 in.



PTH 50PS
Capacity: 2,200 lbs.
Max Lift Height: 31.3 in.

*Contact your local
Crown dealer or
visit crown.com to
learn more.*



ES 4000 Series
Capacity: 3,500 lbs.
Max Lift Height: 132 in.

Dandy Lifts

These inexpensive lifter transporters make any job easier. Dandy Lifts are essential anywhere that lifting, positioning, assembling, stacking, unstacking, transporting or the need for an adjustable height work surface is part of the job.

Dandy Lifts

CAT. NO.	MAX. CAPACITY (LBS.)	OVERALL DIMENSIONS L X W	PLATFORM L X W	LOW HEIGHT	RAISED HEIGHT	LBS.
L-150	330	38.2" x 17.7"	28" x 17.7"	8.3"	29.0"	85
L-250	550	38.2" x 19.7"	31.5" x 19.7"	9.5"	31.7"	115
A-500	1100	42.1" x 23.6"	35.8" x 26.6"	11.8"	36.6"	195
A-800	1760	45.9" x 23.6"	39.4" x 23.6"	13.0"	40.2"	275
A-350W	770	42.1" x 23.6"	35.8" x 23.6"	13.6"	49.8"	230
PLM-150	330	40" x 20"	31.5" x 20"	14.75"	33.25"	150
PLM-250	500	37.5" x 20"	31.5" x 20"	14.25"	32.5"	160



PLM-250



L-250



A-800

L-150 — 300-lb Capacity

L-250 — 550-lb. Capacity



L-150

- IDEAL FOR LIGHT INDUSTRIAL HANDLING
- ATTRACTIVELY FINISHED IN ENAMEL PAINT AND CHROME
- PARKING LOCK
- STEERABLE CASTER-TYPE WHEELS
- INFINITE HEIGHT ADJUSTMENT WITHIN RANGE

A-500 — 1100-lb Capacity

A-800 — 1760-lb. Capacity



A-500

- LIFTS TO OVER 3 FEET
- 20:1 MECHANICAL ADVANTAGE HYDRAULIC SYSTEM
- PARKING LOCK
- STEERABLE CASTER-TYPE WHEELS
- ATTRACTIVELY FINISHED IN ENAMEL PAINT AND CHROME
- INFINITE HEIGHT ADJUSTMENT WITHIN RANGE

A-350W — 770-lb Capacity



A-350W

- OVER 4 FEET OF LIFTING HEIGHT
- PARKING LOCK
- RAPID RISE
- STEERABLE CASTER-TYPE WHEELS
- ATTRACTIVELY FINISHED IN ENAMEL PAINT AND CHROME
- INFINITE HEIGHT ADJUSTMENT WITHIN RANGE

PLM-150 — 330-lb. Capacity

PLM-250 — 500-lb. Capacity



PLM-150

- LIFTS AND LOWERS AT THE TOUCH OF A BUTTON
- ERGONOMIC COMFORT-SHAPED HANDLE
- BATTERY STATUS INDICATOR AND ONBOARD CHARGER
- STEERABLE CASTER-TYPE WHEELS
- HIGH-SPEED ACTUATOR FOR CLEAN, PRECISE POSITIONING

SHIPPING INFORMATION: 1-2 Weeks, F.O.B. Manilla, AR

SCISSORS LIFT TABLES



SCISSORS LIFTS

Production (P) Series Scissors Lift Tables:

Product No.	Capacity	Lowered Height	Raised Height	Std Min Platform	Opt Max Platform	Speed Sec	Motor HP	Wt (lbs)
P-2536	2,500	6-1/2"	42-1/2"	24" x 48"	48" x 72"	11	2	600
P-4036	4,000	6-1/2"	42-1/2"	24" x 48"	48" x 72"	17	2	650
P-6036	6,000	6-1/2"	42-1/2"	24" x 48"	48" x 72"	23	2	680
P-8036	8,000	7-1/2"	43-1/2"	26" x 48"	48" x 72"	28	2	850
P-2548	2,500	7"	55"	24" x 64"	48" x 96"	19	2	730
P-4048	4,000	7"	55"	24" x 64"	48" x 96"	28	2	830
P-6048	6,000	7"	55"	24" x 64"	48" x 96"	38	2	850
P-8048	8,000	8-3/4"	56-3/4"	26" x 64"	48" x 96"	44	2	1,150
P-2560	2,500	10"	70"	24" x 84"	48" x 120"	28	2	1,000
P-4060	4,000	10"	70"	24" x 84"	48" x 120"	42	2	1,150
P-6060	6,000	10"	70"	24" x 84"	48" x 120"	57	2	1,175
P-8060	8,000	10"	70"	26" x 84"	48" x 120"	64	2	1,450



• **P (P) Series**
2,000 lbs to 8,000 lbs capacity

Heavy Duty (HD) Series Scissors Lift Tables:

Product No.	Capacity	Lowered Height	Raised Height	Std Min Platform	Opt Max Platform	Speed Sec	Motor HP	Wt (lbs)
HD-0836	8,000	9-3/4"	45-3/4"	30" x 60"	54" x 90"	18	5	1,450
HD-1036	10,000	9-3/4"	45-3/4"	30" x 60"	54" x 90"	26	5	1,550
HD-1236	12,000	9-3/4"	45-3/4"	30" x 60"	54" x 90"	27	5	1,600
HD-0848	8,000	10"	58"	30" x 68"	54" x 98"	24	5	1,680
HD-1048	10,000	10"	58"	30" x 68"	54" x 98"	34	5	1,800
HD-1248	12,000	10"	58"	30" x 68"	54" x 98"	35	5	1,880
HD-0860	8,000	10"	70"	30" x 84"	54" x 114"	32	5	1,950
HD-1060	10,000	10"	70"	30" x 84"	54" x 114"	47	5	2,100
HD-1260	12,000	10"	70"	30" x 84"	54" x 114"	48	5	2,190



• **Heavy Duty (HD) Series**
8,000 lbs to 12,000 lbs capacity

Multi-Stage (MSL) Series Scissors Lift Tables:

Product No.	Capacity	Lowered Height	Raised Height	Std Min Platform	Opt Max Platform	Speed Sec	Motor HP	Wt (lbs)
MSL2-248	2,000	10-1/2"	58-1/2"	30" x 42"	48" x 66"	16	2	750
MSL2-448	4,000	12-1/2"	60-1/2"	30" x 42"	48" x 66"	25	2	875
MSL2-648	6,000	13-1/2"	61-1/2"	30" x 42"	48" x 66"	37	2	1,150
MSL2-272	2,000	10-1/2"	82-1/2"	30" x 54"	48" x 78"	23	2	925
MSL2-472	4,000	12-1/2"	84-1/2"	30" x 54"	48" x 78"	37	2	1,075
MSL2-672	6,000	13-1/2"	85-1/2"	30" x 54"	48" x 78"	52	2	1,400
MSL2-1096	10,000	18-3/4"	114-3/4"	48" x 71"	66" x 95"	56	5	2,675
MSL2-1296	12,000	22-3/4"	118-3/4"	48" x 74"	66" x 98"	58	5	2,775
MSL3-8126	8,000	25-1/4"	151-1/4"	42" x 71"	54" x 95"	59	5	2,425
MSL3-10144	10,000	25-1/4"	169-1/4"	42" x 77"	54" x 101"	84	5	3,225
MSL3-12144	12,000	31-1/4"	175-1/4"	42" x 80"	54" x 104"	92	5	3,850



• **MULTI-STAGE (MSL) Series**
2,000 lbs to 12,000 lbs capacity



Standard Voltage is 230V/60/3 phase

This is just a sample of our many models. We also offer:

- **EXTRA WIDE (EW) & VERY WIDE MODELS (VW)**
- **DOUBLE WIDE, DOUBLE LONG & DOUBLE HIGH MODELS**
- **BFL SERIES WHICH ARE LARGER VERSIONS OF THE MSL LIFT SERIES**
 - **COMBINATION LIFT & TURN MODELS**
 - **COMBINATION LIFT & TILT MODELS**

ALL UNITS ARE AVAILABLE IN STAINLESS STEEL

CALL WITH YOUR EXACT REQUIREMENTS & WE WILL PROVIDE EXACT MODELS AND CURRENT PRICING

SHIPPING INFORMATION: 3 WEEKS F.O.B. ST. CHARLES, IL

SCISSORS LIFT TABLES



LOWEST COST PER CYCLE

Our warranties start at **250,000 cycles** for (P) tables, which is by far the best in the industry. We go up from there to **1,000,000 cycles** for (HC) High Cycle Lifts and **3,000,000 cycles** for (UHC) Ultra High Cycle Lifts. **This outstanding longevity means lowest cost per cycle and best value for you.**

WE DO THE HARD STUFF!

Because of our continuous R & D programs, we are continually pushing the boundaries of lift table performance. We go well beyond "clean sheet" custom design. Many of these developments can be applied to other customer applications:

- Position control systems with guaranteed accuracy of $\pm .030''$
- Simpler, less expensive position control with $\pm 1/8''$ accuracy
- 200 feet per minute down speeds
- Multi-lift synchronization on a single power unit
- "Intrinsically Safe" wiring as a low cost alternative to some explosion proof applications
- Customer control interfaces with sophisticated programmable controllers
- Super large – Super high capacity – Super unusual custom platform and lift configurations

A SAMPLING OF WHAT HAS BEEN DONE



**WE DO CUSTOM DESIGNS EVERY DAY. CALL WITH YOUR REQUIREMENTS
AND WE WILL RESPOND WITH COMPLETE SPECIFICATIONS AND CURRENT PRICING.**

SHIPPING INFORMATION: 3 WEEKS F.O.B. ST. CHARLES, IL

EZ Loader

- Rotator Ring Diameter = 43.0" (1092 mm)
- Lowered Height = 10.5" (267 mm)
- Raised Height = 30.5" (775 mm)
- Base Frame Length = 49.0" (1245 mm)
- Base Frame Width = 24.3" (617 mm)
- Minimum Self Leveling Capacity = 250 lbs. (113 kgs)
- Maximum Self Leveling Capacity = 3500 lbs. (1588 kgs)
- Maximum Load Capacity = 4000 lbs. (1814 kgs)
- Travel = 20.0" (508 mm)
- Air Pressure Capacity Adjustment = Infinite (10-60 psi/ 0.7-4.1 bar)
- On-board Capacity Adjustment = 3 position knob (light-medium-heavy)



The EZ-Adjust Knob allows adjustment of the collapsed capacity up to 1200 lbs. without the need to change air pressure.

Self-Leveling Pallet Positioner



SHIPPING INFORMATION:
2 Days, F.O.B. Ontario, CA
or Indianapolis, IN

Optional Accessories

- EZ-BRK Rotator Ring Brake to Prevent Rotation
- EZ-SLP Semi-Live Portability for Moving Unloaded Lift (2 Wheels & Dolly Handle)
- EZ-ABS Accordion Bellows Skirting with Frame

Other options are also available. Please contact your local Crown representative.

PalletPal® 360 - Spring Actuated

Dampener provides smooth, gradual raising and lowering without overshoot or bounce.

Heavy-duty springs bring pallet to most convenient height.

Rugged tubular steel frame for loads to 4500 lbs.



Low-friction bearing-supported turntable for near-side loading.

Wide base for free standing stability.

Fork pockets for relocation by fork truck.



With inherent stability and no power sources or connections, the fully automated mechanical PalletPal 360 is virtually maintenance free. The turntable is easily rotated, even when fully loaded, and allows for nearside loading and unloading without walking around the unit. It has a rugged tubular steel frame for loads up to 4500 lb. Heavy duty springs bring pallet to the most convenient loading and unloading height and the low friction bearing supported turntable aides near-side loading and unloading.

CAT. NO.	CAPACITY (LBS.)	TURNTABLE DIAMETER	LOWERED HEIGHT	RAISED HEIGHT	LBS.
PalletPal 360 Spring Range 4	220-4500	43"	9.5"	28"	420
PalletPal 360 Air	400-4500	43.625"	9.5"	27.75"	460

Note: Phenolic frame cover is available.

SOUTHWORTH

PalletPal®

Eliminate lifting, bending and stretching — the primary causes of back injury. This simple, automatic unit is ideal for most applications. It incorporates a turntable to allow nearside loading and a system of springs and shock absorbers, which lower and raise the unit as pallets are built up and broken down, to maintain a constant working height. No power or air supply is required. Pallet loads up to 4500 lbs. can be handled.

Floor Height / Floor Level Lift Tables

Southworth Floor Height / Floor Level lift tables are low-profile lift tables that feature a unique pan-style platform that lowers to floor or near floor height so that they can be fed and offloaded by hand pallet trucks.

- Pan-Style platform lowers to floor height
- Floor level platform can be loaded and unloaded with hand pallet truck
- Safety yellow, elastomeric edge protects workers



MODEL NO.	CAPACITY (LBS.)	RAISED HEIGHT	LOW HEIGHT	PLATFORM SIZE	MOTOR HP	VOLTAGE/ PHASE/Hz	LBS.
ZLS2-35	2000	35.375"	.375"	50 x 48"	1.0	115/1/60	1425

PalletPal® Pallet Rotator / Inverter

The PalletPal Pallet Rotator / Pallet Inverter eliminates the need for manually restacking pallets. Rotate a pallet load 180 degrees in under 1 minute. Uses include:

- Replace broken pallets
- Switch loads to/from in-house or shipping pallets
- Transfer from pallets to slip sheets
- Replace damaged goods at the bottom of the load



MODEL NO.	CAPACITY (LBS.)	MAX. CLAMP OPENING	MIN. CLAMP OPENING	MAX. LOAD SIZE W X D X H	LBS.
SR-44-60	4400	60"	30"	48 x 48 x 60"	3800

SHIPPING INFORMATION: 1 Week, F.O.B. Manilla, AR

Lift/Tilt Tables

1000/2000/4000 lbs.



OPTIONS

SAFETY

Velocity fuses on each cylinder to eliminate the table collapsing due to hose failure

TILT ANGLE

0-30/45°

LOWERED HEIGHT

12"

FRONT RETAINING LIP

8" high (standard)

POWER SUPPLIES

A/C 110/1/60 volt (standard)

Hand or foot operated

A/C 460/575/3/60 volt (opt.)

Hand or foot operated

Air/Hydraulic

Foot operated (standard)

Hand operated (optional)

OPTIONS

- Platforms - wider or deeper
- Bellow safety skirting
- Stainless steel, galvanized or 'steel-it' painted units
- Lift/tilt - reduced or increased

Lift/Tilt Tables

36" TRAVEL - 48" X 48" PLATFORM - TILT ANGLE 0 - 45°

CAT. NO.	CAPACITY (LBS.)	LOWERED HEIGHT (IN.)	TRAVEL (IN.)	TOTAL HEIGHT (IN.)	STANDARD	OVERSIZED	UP SPEED APPROX.	MOTOR HP
					PLATFORM & BASE W X D (IN.)	PLATFORM UP TO W X D (IN.)		
TR-SL 36-10	1000	12	36	48	48 x 48	72 x 72	20	1
TR-SL 36-20	2000	12	36	48	48 x 48	72 x 72	30	1
TR-SL 36-40	4000	12	36	48	48 x 48	72 x 72	35	1½

SHIPPING INFORMATION: 5-6 Weeks

Tote Box Tilters

2000/4000/6000 lbs.

The portable tote box tilter is designed to make the lifting, handling and positioning of small parts containers easy on the worker's back.

- Tilts hydraulically to 94°
- Makes parts easily reachable - prevents back strain; increases productivity

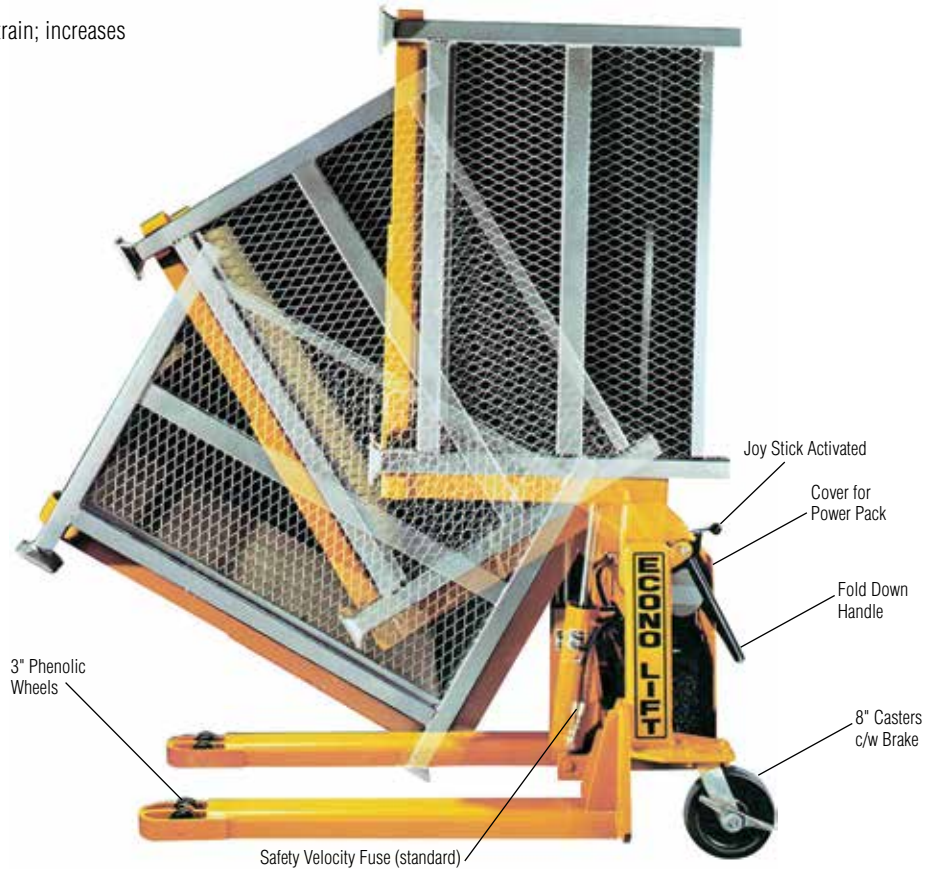

POWER SUPPLIES

D/C Battery

Joy stick controlled

Air/Hydraulic

- Foot pedal (80 psi, 20 cfm min.)
- Hand-held pendants optional

A/C 115/60/1

Hand-held pendant

OPTIONS

- Forks - longer/shorter, higher/lower to 3", wider/narrower
- Tray attachment
- Height of backplate at 90° can be higher or lower

OPTIONS

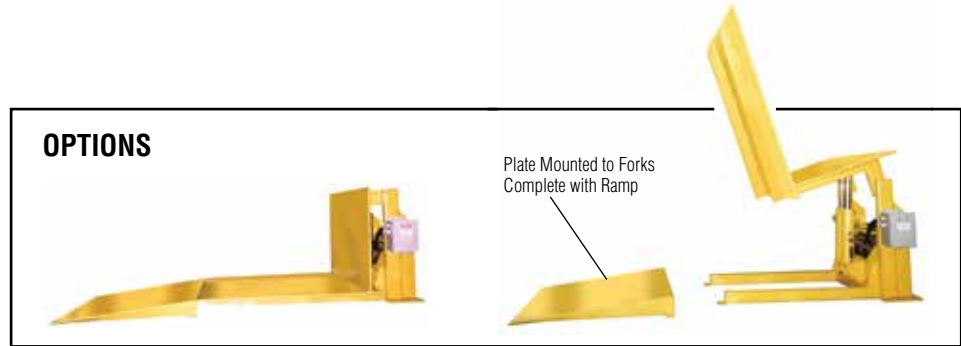

SPECIFICATIONS	TR 20	TR 40/TR 60
Capacity (lbs.)	2000	4000/6000
Load Center (in.)	17	21
Lowered Height (in.)	3½	3½
Lift (in.)	35½	35½
Tilt Angle	94°	94°
Fork Length (in.)	34	42
Fork Width O.D. (in.)	21	27
Fork Width (in.)	6	7
Overall Length (in.)	48	58
Width (in.)	28	36
Height (in.)	27½	28
Weight (lbs.)	500	600
Load Wheels (in.)	3 x 1½	3 x 1½
Caster (in.)	6	8

Tote Box Tilters

CAT. NO.	CAPACITY (LBS.)
TR20	2000
TR40	4000
TR60	6000

SHIPPING INFORMATION:
 Tot Box Tilters - 4 Weeks, F.O.B. Mississauga, ON;
 Lift/Tilt - 5-6 Weeks, F.O.B. Mississauga, ON

LIFT TABLES

2,000 / 3,000 / 4,000 / 5,000 / 6,000 LBS



SPECIFICATIONS

STANDARD 24" WIDE BASE LIFT TABLES

MODEL NO.	CAPACITY (LBS.)	STD. PLAT. BASE (W x L) (IN.)	OVERSIZED PLATFORMS (UP TO) (IN.)	LOW HT (IN.)	RAISED HT (IN.)	UP SPEED (SEC.)	MOTOR (H.P.)	VOLT/HP/HZ	SHIP WEIGHT (LBS)
24" TRAVEL - 24" WIDE x 36" LONG PLATFORM/BASE									
SL24-20	2,000	24 x 36	48 x 60	9	33	15	1	115/1/60	450
SL24-40	4,000	24 x 36	48 x 60	9	33	21	1	115/1/60	470
SL24-60	6,000	24 x 36	48 x 60	9	33	32	1	115/1/60	520
36" TRAVEL - 24" WIDE x 48" LONG PLATFORM/BASE									
SL36-20	2,000	24 x 48	48 x 72	9	45	20	1	115/1/60	600
SL36-30	3,000	24 x 48	48 x 72	9	45	30	1	115/1/60	620
SL36-40	4,000	24 x 48	48 x 72	9	45	37	1	115/1/60	650
SL36-50	5,000	24 x 48	48 x 72	9	45	40	1	208, 220, 460, 575/3/60	680
SL36-60	6,000	24 x 48	48 x 72	9	45	48	1	208, 220, 460, 575/3/60	700
42" TRAVEL - 24" WIDE x 60" LONG PLATFORM/BASE									
SL42-20	2,000	24 x 60	48 x 84	9	51	25	1	115/1/60	625
SL42-40	4,000	24 x 60	48 x 84	9	51	47	1	115/1/60	800
SL42-60	6,000	24 x 60	48 x 84	9	51	50	1	208, 220, 460, 575/3/60	950
48" TRAVEL - 24" WIDE x 72" LONG PLATFORM/BASE									
SL48-20	2,000	24 x 72	48 x 96	9	57	32	1	115/1/60	800
SL48-40	4,000	24 x 72	48 x 96	9	57	50	1	115/1/60	950
SL48-60	6,000	24 x 72	48 x 96	9	57	56	1	208, 220, 460, 575/3/60	1,200

SPECIFICATIONS - wide based units; for wider platform applications and greater stability.

36" WIDE BASE LIFT TABLES

MODEL NO.	CAPACITY (LBS.)	STD. PLAT. BASE (W x L) (IN.)	OVERSIZED PLATFORMS (UP TO) (IN.)	LOW HT (IN.)	RAISED HT (IN.)	UP SPEED (SEC.)	MOTOR (H.P.)	VOLT/HP/HZ	SHIP WEIGHT (LBS)
24" TRAVEL - 36" WIDE x 36" LONG PLATFORM/BASE									
3SL24-20	2,000	36 x 36	60 x 60	9	33	15	1	115/1/60	480
3SL24-40	4,000	36 x 36	60 x 60	9	33	21	1	115/1/60	520
3SL24-60	6,000	36 x 36	60 x 60	9	33	32	1	115/1/60	550
36" TRAVEL - 36" WIDE x 48" LONG PLATFORM/BASE									
3SL36-20	2,000	36 x 48	60 x 72	9	45	20	1	115/1/60	750
3SL36-40	4,000	36 x 48	60 x 72	9	45	38	1	115/1/60	790
3SL36-60	6,000	36 x 48	60 x 72	9	45	48	1	208, 220, 460, 575/3/60	850
42" TRAVEL - 36" WIDE x 60" LONG PLATFORM/BASE									
3SL42-20	2,000	36 x 60	60 x 84	9	51	25	1	115/1/60	830
3SL42-40	4,000	36 x 60	60 x 84	9	51	47	1	115/1/60	890
3SL42-60	6,000	36 x 60	60 x 84	9	51	50	1	208, 220, 460, 575/3/60	950
48" TRAVEL - 36" WIDE x 72" LONG PLATFORM/BASE									
3SL48-20	2,000	36 x 72	60 x 96	9	57	32	1	115/1/60	1,100
3SL48-40	4,000	36 x 72	60 x 96	9	57	50	1	115/1/60	1,200
3SL48-60	6,000	36 x 72	60 x 96	9	57	56	1	208, 220, 460, 575/3/60	1,280

48" WIDE BASE LIFT TABLES

MODEL NO.	CAPACITY (LBS.)	STD. PLAT. BASE (W x L) (IN.)	OVERSIZED PLATFORMS (UP TO) (IN.)	LOW HT (IN.)	RAISED HT (IN.)	UP SPEED (SEC.)	MOTOR (H.P.)	VOLT/HP/HZ	SHIP WEIGHT (LBS)
24" TRAVEL - 48" WIDE x 36" LONG PLATFORM/BASE									
4SL24-20	2,000	48 x 36	72 x 60	9	33	15	1	115/1/60	700
4SL24-40	4,000	48 x 36	72 x 60	9	33	24	1	115/1/60	740
4SL24-60	6,000	48 x 36	72 x 60	9	33	34	1	115/1/60	780
36" TRAVEL - 48" WIDE x 48" LONG PLATFORM/BASE									
4SL36-20	2,000	48 x 48	72 x 72	9	45	20	1	115/1/60	840
4SL36-40	4,000	48 x 48	72 x 72	9	45	38	1	115/1/60	890
4SL36-60	6,000	48 x 48	72 x 72	9	45	48	1	208, 220, 460, 575/3/60	950
42" TRAVEL - 48" WIDE x 60" LONG PLATFORM/BASE									
4SL42-20	2,000	48 x 60	72 x 84	9	51	26	1	115/1/60	890
4SL42-40	4,000	48 x 60	72 x 84	9	51	42	1	115/1/60	950
4SL42-60	6,000	48 x 60	72 x 84	9	51	50	1	208, 220, 460, 575/3/60	1,000
48" TRAVEL - 48" WIDE x 72" LONG PLATFORM/BASE									
4SL48-20	2,000	48 x 72	72 x 96	9	57	32	1	115/1/60	950
4SL48-40	4,000	48 x 72	72 x 96	9	57	50	1	115/1/60	1,100
4SL48-60	6,000	48 x 72	72 x 96	9	57	56	1	208, 220, 460, 575/3/60	1,200

See page 168 for options available.

CAPACITY

- 2,000/3,000/4,000/5,000/6,000 lbs.

PLATFORM SIZES

- 24" wide x 36" long to 72" wide x 96" long

BASE SIZES

- Standard 24", 36", 48" wide x 36", 48", 60", 72" long

TRAVEL

- 24", 36", 42", 48" vertical travel

LOWERED HEIGHT

- 9" (special heights available)

SAFETY

- Velocity fuse is standard on each cylinder
- Heavy duty hydraulic cylinders - chrome plated rod with polyurethane seals

POWER SUPPLIES

- A/C 110/1/60 volt (standard) Hand or foot operated
- A/C 460/575/3/60 volt (opt.) Hand or foot operated
- Air/Hydraulic Foot operated (standard) Hand operated (optional)

- Internally mounted
- Easily accessible for maintenance or repair
- Motors - Single phase 1 h.p. and three phase 1-1/2 h.p. - hand or foot operated standard

MAINTENANCE

- Hinged table top provides easy access to power unit and cylinders
- Self lubricated bronze bushings on all wear points

OPTIONS

- Oversized platforms
- Beveled edges for pit mounting
- Eye-bolts for pit mounting
- Rotating tops - spring detents - manual detents
- Roller conveyor, Ball transfer tops
- Bellow safety skirting
- Safety tape switch
- Safety touch bars
- Semi-portable
- Portable
- Tandem lifts
- Double scissor lifts

LIFT TABLES

2,000 / 3,000 / 4,000 / 5,000 / 6,000 LBS

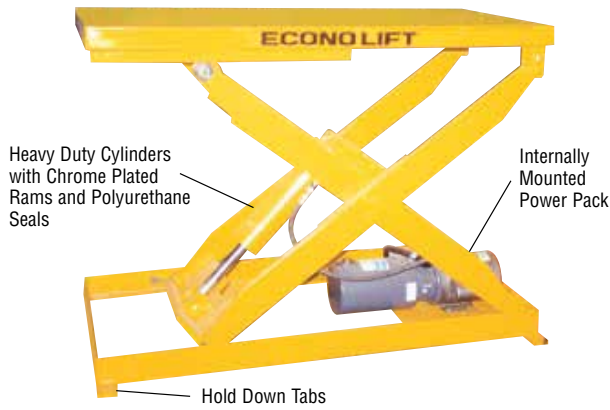

OPTIONS

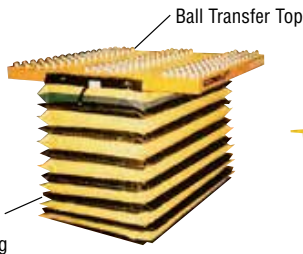
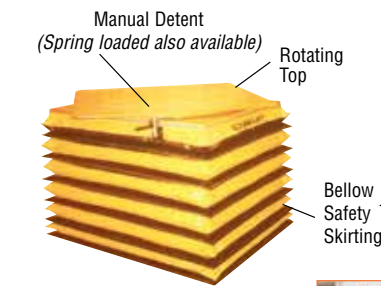

WIDE BASE LIFT TABLE
Oversize Checker Board Top

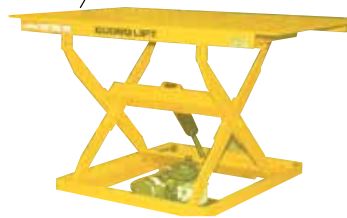

TANDEM LIFT

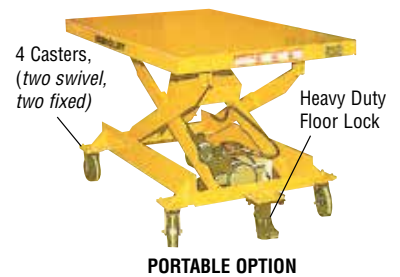
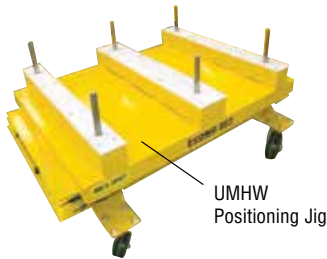

Gravity Conveyor

- 1.9" diameter, 200-lb. capacity 16-ga. galvanized steel rollers
- Mounted in 1" x 2 5/8" x 1" 12-ga. galvanized steel channels

CAT. NO.	BETWEEN FRAME DIMENSION	ROLLER CENTERS	LENGTH
RF125-191631R-16-3-060	16"	3"	5'
RF125-191631R-16-3-120	16"	3"	10'
RF125-191631R-16-2-060	16"	2"	5'
RF125-191631R-16-2-120	16"	2"	10'
RF125-191631R-24-3-060	24"	3"	5'
RF125-191631R-24-3-120	24"	3"	10'
RF125-191631R-24-2-060	24"	2"	5'
RF125-191631R-24-2-120	24"	2"	10'

Gravity Conveyor

- 1 3/8" diameter, 90-lb. capacity 18-ga. galvanized steel rollers
- Mounted in 1" x 2 5/8" x 1" 12-ga. galvanized steel channels

CAT. NO.	BETWEEN FRAME DIMENSION	ROLLER CENTERS	LENGTH
RF125-141831R-16-2-060	16"	2"	5'
RF125-141831R-16-2-120	16"	2"	10'
RF125-141831R-16-1.5-060	16"	1.5"	5'
RF125-141831R-16-1.5-120	16"	1.5"	10'
RF125-141831R-24-2-060	24"	2"	5'
RF125-141831R-24-2-120	24"	2"	10'
RF125-141831R-24-1.5-060	24"	1.5"	5'
RF125-141831R-24-1.5-120	24"	1.5"	10'

SHIPPING INFORMATION: Call for Availability, F.O.B. Sterling, IL



LiftMat Low-Profile Lift Tables

- 2200 lb. capacity
- 3.25" lowered height
- 31.5" raised height
- 24" x 66" or 48" x 72" platforms available

SHIPPING INFORMATION: 4-5 Weeks, F.O.B. Manila, AR

CAT. NO.	OVERALL CAP. (LBS.)	RAISED HEIGHT	LOWERED HEIGHT	STANDARD BASE & PLATFORM	MAXIMUM PLATFORM	MOTOR HP	VOLTAGE/ PHASE/HZ	SHIPPING WEIGHT (LBS.)
LM2.2-28	2200	34.65"	3.15"	24" x 66"	48" x 96"	1.0	115/1/60	600

Options & Accessories:

- Hand Pallet Truck Accessible Ramp - 30" long ramp with diamond plate
- Bellows Accordion Skirting - Black and yellow vinyl skirting wraps entire unit to keep underneath free from debris. Pleats expand and contract as unit raises and lowers.
- One Touch Auto Leveling - Lift platform will raise or lower a preset increment at the touch of a button. This is especially helpful in palletizing applications where box dimensions remain constant from load to load.

Backsaver Hydraulic Scissor Lift Tables

- Available in many basic sizes and capacities to lift and position loads up to 6000 lbs. at heights up to 48"
- Wide range of power options, controls, tabletops and base configurations that can be specified for each of the many basic sizes gives the user an almost unlimited choice of variations

CAT. NO.	CAPACITY (LBS.)	PLATFORM W X L	RAISED HEIGHT	LOWERED HEIGHT	LBS.
LS05-30W-16x24	500	16" x 24"	36"	6"	200
LS1-30-16x24	1000	16" x 24"	36"	6"	225
LS2-36-24x48	2000	24" x 48"	43.25"	7.25"	600
LS2-36-48x48	2000	48" x 48"	43.25"	7.25"	750
LS4-36-24x48	4000	24" x 48"	43.25"	7.25"	650
LS4-36-48x48	4000	48" x 48"	43.25"	7.25"	750



SHIPPING INFORMATION: 3 Weeks, F.O.B. Manila, AR

SOUTHWORTH

LiftMat Low-Profile Lift Tables

Get the advantage of four sided accessibility without the expense or hassle of digging a pit for your lift table. LiftMat Low-Profile lift tables have a collapsed height as low as 3.25 inches. An optional ramp allows the low-profile lift table to be fed with a hand pallet truck. A full perimeter Toe Guard stops the descent of the lift table when it comes into contact with any obstruction. LiftMat Low Profile Lift tables are best suited to applications where the load is evenly distributed.

Scissor Lift Tables

Southworth Backsaver Hydraulic Lift Tables are extremely rugged and reliable. Thousands of Backsaver Lifts are in use throughout the U.S. for machine feeding, work positioning, assembly, order picking, pallet loading and a wide range of other applications.

ROLL-A-WAY

Roller Conveyors

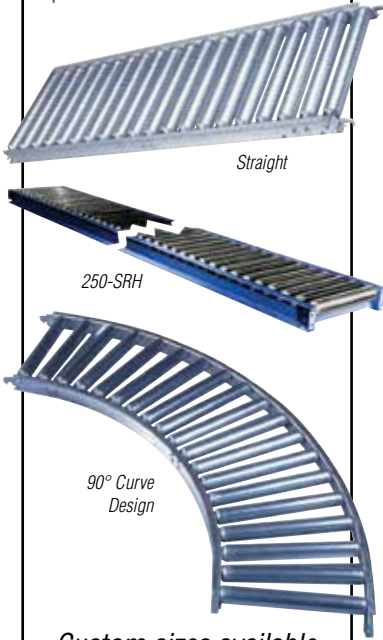
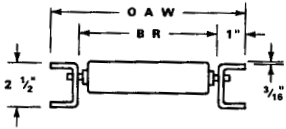

Custom sizes available

Floor Supports

- Prepunched feet for permanent installation
- Legs have adjustable plates for incline or decline
- Powder coated blue



Medium Duty

Permanent Conveyor Support

Medium-Duty Floor Supports

Formed 12 gauge channel legs. Capacity: 1000 lbs. Available in 12", 18" and 24" widths.

CAT. NO.	TOP OF SUPPORT HEIGHT
PSL-__-1417	14" to 17"
PSL-__-1723	17" to 23"
PSL-__-2430	24" to 30"
PSL-__-3137	31" to 37"
PSL-__-3844	38" to 44"



Super Duty

Super-Duty Floor Supports

4" structural steel upright. 1" adjustable increments. Capacity: 4000 lbs. Available in 12", 18" and 24" widths.

CAT. NO.	TOP OF SUPPORT HEIGHT
PSXH-__-1723	17" to 23"
PSXH-__-2430	24" to 30"
PSXH-__-3137	31" to 37"
PSXH-__-3844	38" to 44"

ROLLER CONVEYORS

1 3/8" Light-Medium Weight Packages - Available in 10', 5' and 90° sections

Model 138SR - 1 3/8" dia. Galvanized Rollers 2 1/2" x 1" x 12 ga. Steel Frame Design

CAT. NO.	ROLLER CENTERS	CAT. NO.	ROLLER CENTERS
12" Overall Width		15" Overall Width	
138SR-1512	1 1/2"	138SR-1515	1 1/2"
138SR-0312	3"	138SR-0315	3"
18" Overall Width		24" Overall Width	
138SR-1518	1 1/2"	138SR-1524	1 1/2"
138SR-0318	3"	138SR-0324	3"

1 3/8" Light-Medium Weight Packages - Available in 10', 5' and 90° sections

Model 138AR - 1 3/8" dia. Aluminum Rollers 2 1/2" x 1" x 12 ga. Aluminum Frame Design

CAT. NO.	ROLLER CENTERS	CAT. NO.	ROLLER CENTERS
12" Overall Width		15" Overall Width	
138AR-1512	1 1/2"	138AR-1515	1 1/2"
138AR-0312	3"	138AR-0315	3"
18" Overall Width		24" Overall Width	
138AR-1518	1 1/2"	138AR-1524	1 1/2"
138AR-0318	3"	138AR-0324	3"

2" Heavy-Duty Weight Packages - Available in 10', 5' and 90° sections

Model 200SRH - 2" dia. x 12 ga. Roller, 3 1/2" x 1" x 10 ga. Steel Frame Design, Welded

CAT. NO.	ROLLER CENTERS	CAT. NO.	ROLLER CENTERS
12" Overall Width		15" Overall Width	
200SRH-0312	3"	200SRH-0315	3"
200SRH-0612	6"	200SRH-0615	6"
18" Overall Width		24" Overall Width	
200SRH-0318	3"	200SRH-0324	3"
200SRH-0618	6"	200SRH-0624	6"

2 1/2" Heavy-Duty Weight Packages - Available in 10', 5' and 90° sections

Model 250SRH - 2 1/2" dia. x 11 ga. Roller, 4" x 5.4" Structural Channel Spring-Loaded Frame Design

CAT. NO.	ROLLER CENTERS	CAT. NO.	ROLLER CENTERS
12" Overall Width		24" Overall Width	
250SRH-0312	3"	250SRH-0324	3"
250SRH-0612	6"	250SRH-0624	6"
18" Overall Width		36" Overall Width	
250SRH-0318	3"	250SRH-0336	3"
250SRH-0618	6"	250SRH-0636	6"

NOTE: Rollers extend 1/2" above steel frame.

Heavy-Duty Floor Supports

2" square tubing legs. Capacity: 2000 lbs. Available in 12", 18" and 24" widths.

CAT. NO.	TOP OF SUPPORT HEIGHT
PSH-__-1723	17" to 23"
PSH-__-2430	24" to 30"
PSH-__-3137	31" to 37"
PSH-__-3844	38" to 44"

SHIPPING INFORMATION: 3 Weeks, F.O.B. Gurnee, IL



Flexible Expandable Conveyors Medium-Duty Accordion Wheel Design

226-pound capacity per lineal foot. 24" wide. 8 skatewheels per axle. Standard height adjustment 28-44". Please specify steel or nylon skatewheels.

CAT. NO.	CONTRACTED LENGTH	EXTENDED LENGTH
224-08	2'4"	8'11"
224-12	3'3"	12'10"
224-16	4'3"	16'9"
224-20	5'2"	20'9"
224-24	6'2"	24'8"

14" and 18" widths also available. Other lengths available.

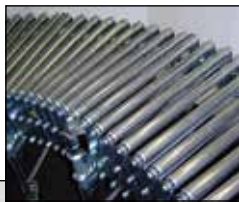

Accordion Roller Conveyors Medium-Duty Accordion Roller — 24" Widths

200-pound capacity per lineal foot. 1 1/8" O.D. galvanized steel rollers on 5 1/4" axle centers. Standard height adjustment 28-36". 5" x 1 1/2" swivel/wheel lock casters. Nine rollers per section.

CAT. NO.	CONTRACTED LENGTH	EXTENDED LENGTH	LEG SETS/UNIT	BED SECTIONS/UNIT
RLR24008S	2'7"	8'6"	3	2
RLR24012S	3'9"	12'2"	4	3
RLR24016S	4'10"	15'10"	5	4
RLR24020S	5'11"	19'6"	6	5
RLR24024S	7'0"	23'2"	7	6

SHIPPING INFORMATION: 3 Weeks, F.O.B. Jonesboro, AR

- Customized to your specifications
- Available in various mesh sizes
- Offers lightweight, durable containment
- Will not rust or dent
- Keeps views of conveyor unobstructed
- Optional non-porous liner



SHIPPING INFORMATION: 2 Weeks, F.O.B. Colchester, CT

ROLL-A-WAY

Flexible Expandable Conveyors

Lets you save valuable floor space when the conveyor is not in use. And because it's so flexible, you can position the conveyor wherever you need it. With expansion ratios up to 4:1, you can store 12 feet of conveyor in a 3-foot area. Lengths available up to 60 feet.

Accordion Roller Conveyors

Medium-duty flexible conveyors for packages with flat or irregular bottoms. Box stop, pull handle and couplers standard.

SHOP & WAREHOUSE

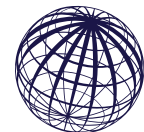

InCord[®]
Custom Safety Netting Solutions

Conveyor Guard Systems

Keep things moving!
Fall protection for stock and personnel. Call for a custom configuration to fit your needs.



Model FE - Fork Extensions

PRODUCT FEATURES:

- Ideal for oversized loads.
- Easy installation onto existing forks.
- Fits standard fork thicknesses.
- Standard fork extension widths 4" through 7".
- Standard fork extension lengths 42" through 96".

INSTOCK PROGRAM

QUICKSHIP PROGRAM



WARNING

- Extensions shall not exceed 1 1/2X the length of the existing forks.
- Extension capacities are reduced beyond existing fork tips (Approx. 60%).
- Do not tip-load the fork extensions.
- Load center of gravity must not extend past existing fork tips.
- Capacity of lift truck and attachment combination may be less than capacity shown on attachment. Consult lift truck manufacturer.

SPECIFICATIONS

Model Number (Pair)	Extension Length (in.)	Fork Width (in.)	Minimum Fork Length (in.)	Load Center (in.)	Rated Capacity Each (lbs.)	Weight Each (lbs.)
FE4-42	42	4	28	21	1925	25
FE4-48	48	4	32	24	1700	28
FE4-54	54	4	36	27	1500	32
FE4-60	60	4	40	30	1350	35
FE4-63	63	4	42	32	1275	37
FE4-66	66	4	44	33	1225	38
FE4-72	72	4	48	36	1125	42
FE5-42	42	5	28	21	2525	30
FE5-48	48	5	32	24	2200	34
FE5-54	54	5	36	27	1950	38
FE5-60	60	5	40	30	1750	42
FE5-63	63	5	42	32	1675	45
FE5-66	66	5	44	33	1600	47
FE5-72	72	5	48	36	1475	51
FE5-96	96	5	64	48	1100	67
FE6-42	42	6	28	21	3200	36
FE6-48	48	6	32	24	2800	41
FE6-54	54	6	36	27	2500	46
FE6-60	60	6	40	30	2250	51
FE6-63	63	6	42	32	2125	53
FE6-66	66	6	44	33	2025	55
FE6-72	72	6	48	36	1875	60
FE6-96	96	6	64	48	1400	80
FE7-42	42	7	28	21	4000	42
FE7-48	48	7	32	24	3500	48
FE7-54	54	7	36	27	3100	53
FE7-60	60	7	40	30	2800	59
FE7-63	63	7	42	32	2675	62
FE7-66	66	7	44	33	2550	65
FE7-72	72	7	48	36	2325	71
FE7-96	96	7	64	48	1750	94

Model FC - Fork Covers

Caldwell Fork Covers are specifically designed to protect loads which cannot be marred or scratched. Made from durable nylon webbing, these covers are economical and long lasting.

QUICKSHIP PROGRAM

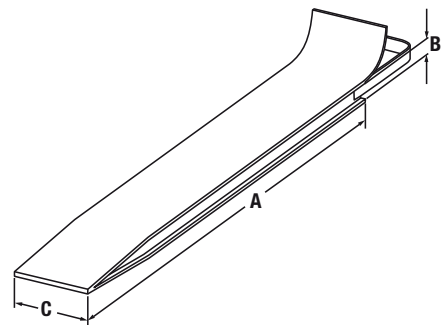

SPECIFICATIONS

Model Number (Pair)	Fork Cover Dimensions (in.)		
	A	B	C
42-1 1/2-4	42	1-1/2	4
48-1 1/2-5	48	1-1/2	5
48-2-6	48	2	6
54-1 1/2-5	54	1-1/2	5
84-4-6	84	4	6

Models 36 & 36E - Fiberglass Battery Lifting Beams

Used for applications that require a non-conductive beam such as lifting industrial fork lift truck batteries.



PRODUCT FEATURES:

- Lightweight units — 70% lighter than other beams.
- Models are available for handling batteries of equal length or of different lengths.
- Heavy duty 4,800 lb. and 7,000 lb. capacities.
- Non-conductive fiberglass beam construction.
- Acid-resistant, coated polyester straps and hooks.
- Standard drop sling length is 10", other lengths available upon request.

Model 36 - Fixed (Batteries of Equal Length)



SPECIFICATIONS

Model Number	Rated Capacity (lbs.)	Standard Spread (in.)	Dimensions (in.)						Weight (lbs.)
			A	B	C	D	E	F	
36-2.4	4800	36	5/8	3	6	11	27/32	21/32	16
36-3.5	7000	36	3/4	2-3/4	5-1/2	12	1	1	20

NOTE: For battery beams other than standard spread. Measure distance between lifting points. Specify Model 36 with beam spread (in even inches) equal to length measured.

Model 36E - Adjustable (Batteries of Different Length)

SPECIFICATIONS

Model Number	Rated Capacity (lbs.)	Standard Spread (in.)	Dimensions (in.)						Weight (lbs.)
			A	B	C	D	E	F	
36E-2.4	4800	36	5/8	3	6	21	1	1	17
36E-3.5	7000	36	3/4	2-3/4	5-1/2	22-1/2	1-1/8	1-1/8	20

NOTE: For Model 36E lifting beams, battery length cannot differ more than 6 inches from length of beam spread. For battery beams other than standard spread. Take average of shortest and longest batteries, and specify Model 36E with beam spread (in even inches) equal to average lengths. Battery length must be within 12 inches, shortest to longest.

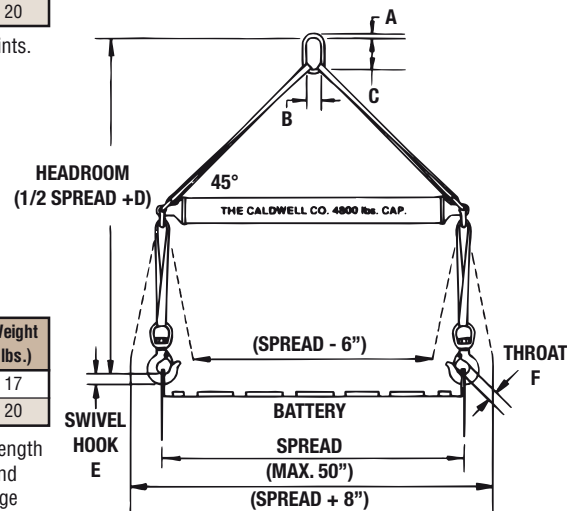
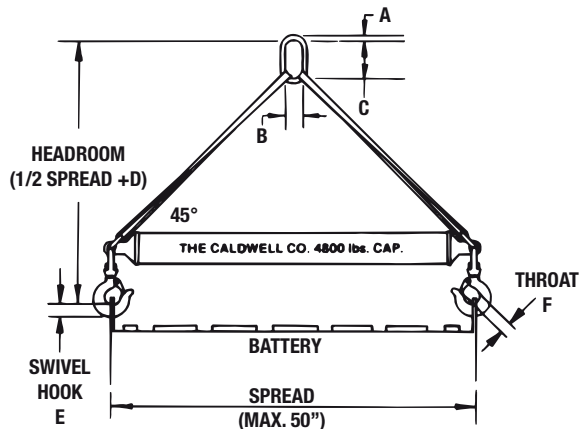

OPTION J: J-Hooks available in place of swivel hooks at a reduced cost.

NOTE: When ordering J-Hook option show Model 36 as 36J, and Model 36E as 36EJ.

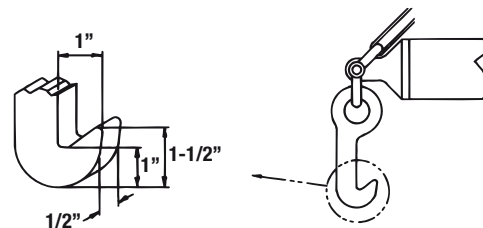



QUICKSHIP PROGRAM



Model RLR - Rug Lifting Rams

PRODUCT FEATURES:

- Available for both Class II and Class III lift trucks.
- Carriage locking pin standard.
- Minimum lost load center.
- Pole made of alloy steel.
- Class II carriage, hanger and baseplate are 1 piece.
- Class III carriage, hanger and baseplate are welded.
- Standard and heavy duty designs available.
- Fork-mounted base unit available.

SPECIFICATIONS - Standard Duty

Model Number	Rated Capacity (lbs.) @72" Load Center	Carriage Class	Pole Length (ft.)	Pole Diameter (in.)	Weight (lbs.)
8B-90	1000	II	9	2-3/4	259
8B-100	1000	II	10	2-3/4	275
8B-110	1000	II	11	2-3/4	292
8B-120	1000	II	12	2-3/4	309
8G-90	1400	II	9	3	291
8G-100	1400	II	10	3	311
8G-110	1400	II	11	3	331
8G-120	1400	II	12	3	351
9B-90	1000	III	9	2-3/4	256
9B-100	1000	III	10	2-3/4	272
9B-110	1000	III	11	2-3/4	289
9B-120	1000	III	12	2-3/4	306

SPECIFICATIONS - Heavy Duty

Model Number	Rated Capacity (lbs.) @72" Load Center	Carriage Class	Pole Length (ft.)	Pole Diameter (in.)	Weight (lbs.)
8D-90	1800	II	9	3-1/4	329
8D-100	1800	II	10	3-1/4	353
8D-110	1800	II	11	3-1/4	377
8D-120	1800	II	12	3-1/4	401
8E-90	2900	II	9	3-3/4	410
8E-100	2900	II	10	3-3/4	443
8E-110	2900	II	11	3-3/4	476
8E-120	2900	II	12	3-3/4	509
8H-90	4300	II	9	4-1/4	505
8H-100	4300	II	10	4-1/4	547
8H-110	4300	II	11	4-1/4	590
8H-120	4300	II	12	4-1/4	633

SPECIFICATIONS - Fork Mounted

Model Number	Rated Capacity (lbs.) @72" Load Center	Overall Length (ft.)	Pole Length (ft.)	Pole Dia. (in.)	Fork Pocket Size (in.)	Fork Pocket Spacing (in.)	Weight (lbs.)
8F-90	1000	11	9	2-3/4	2-1/2 X 7-1/2	31	298
8F-100	1000	12	10	2-3/4	2-1/2 X 7-1/2	31	313
8F-110	1000	13	11	2-3/4	2-1/2 X 7-1/2	31	330
8F-120	1000	14	12	2-3/4	2-1/2 X 7-1/2	31	347

WARNING

Carrying capacity is only for the rug ram. Maximum roll length is 12'.

WARNING

Capacity of lift truck and attachment combination may be less than capacity shown on attachment. Consult lift truck manufacturer.



Secure Your Pallet Jack

Both the Pallet Jack Stop and the Pallet Truck Chock function well on any surface and will not slip. To secure the pallet jack, simply roll the steering wheels up to the pallet jack stop or chock incline and into the holding area.

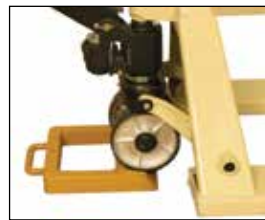

Pallet Jack Stop

Material: Black hard rubber.



Pallet Truck Chock - High Visibility Yellow

Material: Yellow hard rubber.

CAT. NO.	OVERALL DIMENSIONS W X H X D	LBS.
272949	11.75" x 2" x 14"	3.5

CAT. NO.	OVERALL DIMENSIONS W X H X D	LBS.
272175	11.75" x 2" x 14"	3.4

Lifting Slings

Lifting Webbing Slings

- Long-lasting polyester slings are built for dependable lifting, year after year.
- Soft non-scratch slings permit handling of delicate polished surfaces.

Here's a way to lift and move heavy tubing, machinery, supplies and cargo. Made from special high-strength fabrics for extra strength, wear resistance, and extreme flexibility. No factory, warehouse, work yard, or load dock should be without a time and work saving sling.



A. Pro-Edge® (Poly) - DOMESTIC - Eye & Eye Web Sling - Type III & IV

A versatile sling for general use. Use in choker, basket or vertical hitches.

CAT. NO.	SLING WIDTH	EYE LENGTH	RATED CAPACITY (LBS.)		
			CHOKER	VERT.	BASKET
EE1-91PD	1"	9"	1280	1600	3200
EE1-92PD	2"	9"	2480	3100	6200
EE1-93PD	3"	9"	3720	4650	9300
EE1-94PD	4"	12"	4960	6200	12400
EE1-96PD	6"	14"	7440	9300	18600
EE2-91PD	1"	9"	2480	3100	6200
EE2-92PD	2"	9"	4960	6200	12400
EE2-93PD	3"	12"	7440	9300	18600
EE2-94PD	4"	12"	8800	11000	22000
EE2-96PD	6"	14"	13,200	16500	33000



B. Pro-Edge® (Poly) - DOMESTIC - Endless Web Sling - Type V

For heavy-duty use. Unlimited ways of rigging – not limited by configuration of the sling.

CAT. NO.	SLING WIDTH	RATED CAPACITY (LBS.)		
		CHOKER	VERT.	BASKET
EN1-91PD	1"	2500	3200	6400
EN1-92PD	2"	5000	6200	12,400
EN1-93PD	3"	6900	8600	17,200
EN1-94PD	4"	9200	11,500	23,000
EN1-96PD	6"	13,000	16,300	32,600
EN2-91PD	1"	4900	6200	12,400
EN2-92PD	2"	9800	12,200	24,400
EN2-93PD	3"	13,000	16,300	32,600
EN2-94PD	4"	16,500	20,700	41,400
EN2-96PD	6"	23,000	28,600	52,200



C. Cargo - Integral Eye (CIE)

Adds load stability and capacity when lifting extra-wide and awkward loads. Designed as a basket hitch.

CAT. NO.	SLING WIDTH	EYE LENGTH	RATED CAPACITY (LBS.)	MINIMUM BASE LENGTH
			BASKET HITCH	
CIE 293P	6"	12"	18600	3'
CIE 294P	8"	12"	24800	4'
CIE 296P	12"	14"	37200	5'
CIE 396P	18"	24"	37200	8'

SHIPPING INFORMATION: 1 Week, F.O.B. Chicago, IL

A. Yellow Jacket Mild Steel Floor Scale

Features 4' x 4' platforms with 3" profile

CAT. NO.	PLATFORM SIZE	CAPACITY (LBS.)	LBS.
93800	4' x 4'	2500	340
93791	4' x 4'	5000	340

Optional Safety Tread Ramp - Cat. No. 30256 — 4"W x 30"L x 3"H, 225 lbs.

SHIPPING INFORMATION:
1 Week, F.O.B. St. Johnsbury, VT



A.



Yellow Jacket Mild Steel Floor Scale

- Ideal for operations with low light warehouse environments
- Unique multi-ribbed understructure support design

B. Aegis Transport Scale

Built-in break point prevents scale from rolling when lowering platform back to level.

CAT. NO.	MATERIAL	PLATFORM SIZE	CAPACITY (LBS.)	LBS.
97670	Mild Steel	24" x 30" x 1.5"	1000	395
97671	Mild Steel	24" x 30" x 1.5"	2500	395
97672	Stainless Steel	24" x 30" x 1.5"	1000	410
97673	Stainless Steel	24" x 30" x 1.5"	2500	410

SHIPPING INFORMATION:
1 Week, F.O.B. St. Johnsbury, VT



B.



Aegis Transport Scale

- Take hold easy-grip handle
- Use foot to leverage scale backward
- Scale easily rolls to desired location

C. Fork Lift Truck Scales

Indicator: FLI-225 or ZM710

- FLI-225 has two RS-232 serial ports
- ZMZ10 features Ethernet, USB, Serial and Wireless connectivity and is fully programmable
- Wireless units available on the FLSC05-II NTEP units

CAT. NO.	CARRIAGE SIZE**	CAPACITY (LBS.)	RESOLUTION (LBS.)	LBS.
QTLTS System (Non-NTEP)				
QTLTS-II-05-FLI225	16" x 37	5000	1	475
FLSC05 System (NTEP)				
FLSC-II-05-FLI225	16" x 37	5000	5	490
**FLSC-II-05-FLI225-RF	16" x 37	5000	5	510
FLSC-II-05-ZM710	16" x 37	5000	5	495
**FLSC-II-05-ZM710-RF	16" x 37	5000	5	515

** Wireless units
Other carriage widths are available

SHIPPING INFORMATION:
4 Weeks, F.O.B. Fairmont, MN



QTLTS



FLSC



Fork Lift Truck Scales

A fork lift truck scale eliminates the need for a floor scale and attaches to an existing forklift truck cleat carriage. Each electronic scale has four application designed weigh-tronix weigh bars, a weight summing assembly, coiled interface cable, choice of instruments which includes instrument overhead tilt & swivel brackets, power cable, miscellaneous installation hardware and user manual.

A. Low Profile Super Heavy-Duty Formed Base

CAT. NO.	CAPACITY	DIMENSIONS (L X W X H)	FORK OPENINGS	WEIGHT (LBS.)
212299+	.125 cu. yd./2000 lbs.	30" x 28½" x 17"	2½" x 7½" x 18" OC	210
212301+	.25 cu. yd./4000 lbs.	30" x 41½" x 17"	2½" x 10¾" x 29½" OC	260
212305+	.33 cu. yd./4000 lbs.	44" x 41½" x 24"	2½" x 10¾" x 29½" OC	370
212311*	.5 cu. yd./4000 lbs.	44" x 49½" x 24"	2½" x 10¾" x 29½" OC	410

+ - stackable when empty; base is wider than the body
 * - not stackable because the body is 48" wide and the base is "only 40.5" wide

SHIPPING INFORMATION: 2 Weeks, F.O.B. Litchfield MI



B. Large Volume, Low Profile Super Heavy-Duty Structural Base

CAT. NO.	CAPACITY	DIMENSIONS (L X W X H)	FORK OPENINGS	WEIGHT (LBS.)
212361	2.5 cu. yd./6000 lbs.	64" x 67½" x 46"	3" x 10½" x 39" OC	995
212371	3.0 cu. yd./6000 lbs.	64" x 87½" x 46"	3" x 10½" x 39" OC	1085
212376	3.5 cu. yd./6000 lbs.	64" x 101½" x 46"	3" x 10½" x 39" OC	1225

Special base required (Cat. No. 230600) for use with casters.

SHIPPING INFORMATION: 2 Weeks, F.O.B. Litchfield MI



C. Caster Options

- Available in Semi-Steel (SS), Phenolic (PH), Polyurethane (PU) or Mold-on Rubber (MR)

CAT. NO.	DIMENSIONS DIA. X W	MATERIAL	CAPACITY (LBS.)	WEIGHT (LBS.)
240211	6" x 2"	SS	4800	34
240221	6" x 2"	PU	4800	37
240231	6" x 2"	PH	4000	28
240251	6" x 2"	MR	2000	28
240311	6" x 2½"	SS	6000	51
240321	6" x 2½"	PU	600	50
240331	6" x 2½"	PH	6000	37
240351	6" x 2½"	MR	2400	38
240421	8" x 2"	PU	4800	56
240451	8" x 2"	MR	2400	43
240511	8" x 2½"	SS	6000	61
240531	8" x 2½"	PH	6000	46
240541	8" x 2½"	PU	6000	77



D. Towable Rotator Box

- 7-gauge body; 7-gauge fork pockets
- Painted Vista Green
- Palletized for shipping
- Non-stackable
- Non-stock item; manufactured to order



CAT. NO.	CAPACITY	BOX INSIDE DIMENSIONS (L X W X H)	OVERALL DIMENSIONS (L X W X H)	FORK OPENINGS	WEIGHT (LBS.)
250010	1.67 cu. yd./6000 lbs.	60" x 36" x 36"	65" x 41" x 45½" OC	3" x 8" x 28" OC	650
250020	2.00 cu. yd./6000 lbs.	72" x 36" x 36"	77" x 41" x 45½" OC	3" x 8" x 28" OC	725
250050	2.25 cu. yd./6000 lbs.	60" x 48" x 36"	65" x 53" x 45½" OC	3" x 8" x 28" OC	760
250060	2.67 cu. yd./6000 lbs.	72" x 48" x 36"	77" x 53" x 45½" OC	3" x 8" x 28" OC	810

SHIPPING INFORMATION: 5-6 Weeks, F.O.B. Litchfield MI



Low Profile Super Heavy-Duty Formed Base Dumpers

- 7-gauge body; 8-gauge base
- Stackable 3-high empty
- Non-stock item; manufactured to order

Large Volume, Low Profile Super Heavy-Duty Structural Base Dumpers

- 7-gauge body; ¼" base
- Non-stackable
- Wide-body design and convenient working height of 46" make these units natural for handling large, long bulky items. Lids not available.
- Non-stock item; manufactured to order

Caster Options

- Hoppers with casters are easy to roll
- Casters are welded to base of hoppers unless otherwise specified
- Capacity must match or exceed capacity of hopper

Towable Rotator Box

- Designed for the collection and storage of bulk materials.
- The towing tongue (wishbone style) allows for towing at up to 4 MPH.
- Rolls on 8" x 2½" polyurethane casters.
- Fork openings are 3" x 8" to be dumped with a rotating forklift attachment (not included). The box seams are continuously welded.
- Applications: machine shops managing shredded materials, recycling material, bulk material storage.



Low-Profile Manual Tilt Trucks

- Units are designed for manual handling of lightweight materials and roll on 6" x 2" mold-on rubber casters.
- Not to be used with forklift or rotator. Do not exceed your lifting capability. Units are not watertight.

Low-Profile Portable Hopper

- Will need to use knees to return unit to an upright position
- Manufactured to order

Low-Profile Manual Tilt Trucks

- Manufactured from 13-gauge steel with reinforced corners
- Overall height to the top of the push handle is 30"; bucket measures 24" from the floor to the top edge
- Painted Vista Green
- Palletized for shipping
- Manufactured to order

CAT. NO.	CAPACITY	DIMENSIONS (L X W X H)	WEIGHT (LBS.)
271211	.38 cu. yd./1000 lbs.	47 ¹ / ₁₆ " x 30 ¹ / ₁₆ " x 24"	136
271221	.75 cu. yd./1000 lbs.	47 ¹ / ₁₆ " x 57 ¹ / ₁₆ " x 24"	194

SHIPPING INFORMATION: 3-4 Weeks, F.O.B. Litchfield MI



271211

Low-Profile Portable Hopper

- 7-gauge body; 1/4" base
- Non-stackable

CAT. NO.	CAPACITY	DIMENSIONS (L X W X H)	WEIGHT (LBS.)
WITH CASTERS & KNEES, 90° DUMP			
215100	.51 cu. yd./2800 lbs.	48" x 36" x 36"	406
215150	.67 cu. yd./2800 lbs.	48" x 48" x 36"	488
WITH KNEES, 90° DUMP			
215200	.25 cu. yd./2800 lbs.	43" x 31" x 17"	295
215210	.33 cu. yd./2800 lbs.	43" x 41" x 17"	345
215220	.25 cu. yd./2800 lbs.	43" x 62" x 17"	445
215230	.50 cu. yd./2800 lbs.	55" x 48 ¹ / ₂ " x 24"	520
215240	1.00 cu. yd./2800 lbs.	55" x 63 ¹ / ₂ " x 24"	595
215250	1.50 cu. yd./2800 lbs.	76" x 62" x 24"	720

SHIPPING INFORMATION: 5 Weeks, F.O.B. Litchfield MI



215150



215250



AKRO-MILS

Akro-Tilt Trucks

Lightweight tipping trucks make it easy for one person to handle bulky, heavyweight (up to 2000 lb.) jobs

Full, wrap-around tubular frame is constructed of 1" powder-coated steel with enhanced appearance and rust protection. All trucks available in gray or black.

Akro-Carts

Non-tipping carts for large, medium-weight (up to 450 lb.) jobs

Polyethylene container has latch bars that extend around the frame for added strength. Joints are riveted and heavy-duty 90 gallon joints are welded. Frame is made from 16-gauge zinc-plated steel tubing on medium-duty models and powder-coated steel on heavy-duty models. Heavy-duty piano hinge keeps lid propped open during use. All carts available in gray, blue and green (black lid).

Akro-Tilt Trucks

- Ergonomic design makes trucks easy to maneuver.
- Caster wheel has roller bearings for extra stability when pushing, pulling or turning.
- Handle is arc welded and reinforced for optimum durability.



CAT. NO.	DESCRIPTION	W X D X H	WHEEL DIA.	CAPACITY CU. YDS.	(LBS.)	LBS.
77405	Medium Duty 100 gal. cap.	27" x 54" x 36"	12"	1/2	600	94
77505	Heavy Duty 100 gal. cap.	27" x 54" x 36"	10"	1/2	1000	115
77410	Medium Duty 200 gal. cap.	33" x 66" x 42"	12"	1	600	137
77510	Heavy Duty 200 gal. cap.	33" x 66" x 42"	10"	1	1000	150
77610	Super Heavy Duty 200 gal. cap.	33" x 66" x 42"	12"	1	2000	170
77710	Heavy Duty 300 gal. cap.	39" x 85" x 51"	12"	1 1/2	2000	231
77810	Heavy Duty 400 gal. cap.	48" x 85" x 51"	12"	2	2000	252

NOTE: Please specify color when ordering. Lids available for 200-gallon capacity.



76460



76490



76491

Akro-Carts

DESCRIPTION	W X D X H	CAPACITY (LBS.)	LBS. (WITH LID)	WITHOUT LID CAT. NO.	WITH LID (BLACK ONLY) CAT. NO.
Med.-Duty 60 gal. cap.	30 ¹ / ₂ " x 48" x 33 ¹ / ₂ "	300	51	76460	76461
Med.-Duty 90 gal. cap.	30 ¹ / ₂ " x 47" x 39 ¹ / ₂ "	350	56	76490	76491
Heavy-Duty 90 gal. cap.	30 ¹ / ₂ " x 47" x 39 ¹ / ₂ "	450	71	76590	76591

NOTE: Please specify colors when ordering. Optional carts ordered without lids cannot have lids added after production. Single units are shipped completely assembled. When multiple units are ordered, lids are shipped separately and require assembly.

SHIPPING INFORMATION: 4-6 Weeks, F.O.B. Salamanca, NY



*Casters make
hoppers easy
to roll!
Call for details.*



DUMPS ITSELF



RIGHTS ITSELF



LOCKS ITSELF

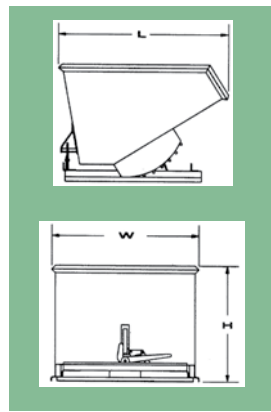

jesco
— Since 1932 —[®]

Self-Dumping Hoppers

50+ models: standard, narrow, low profile, large volume. All-welded construction for strength and durability. Handle scrap easily. Units can be moved with forklift or rolled with casters (optional). Forklift must be used to empty the hopper. Stackable formed base when empty. Hoppers are engineered to dump when the locking handle is tripped and will return to the upright locked position when empty. Units are designed to empty when heaping full to fill up the sloped front to shift the center of gravity to the mouth of the unit. View video www.jescoOnline.com.

Safety lock, Safety retaining chain and trip rope assembly are standard. Painted Vista Green optional choices available.

Super Heavy Duty Formed Base – 7 gauge, stackable

CAT. NO.	YARD CAPACITY	CAPACITY (LBS.)	L X W X H	FORK OPENINGS	LBS.
211301	.25	4000	49" x 30 $\frac{1}{2}$ " x 26 $\frac{1}{2}$ "	2 $\frac{1}{2}$ " x 20"	375
211305	.33	4000	48 $\frac{1}{2}$ " x 30 $\frac{1}{2}$ " x 31 $\frac{1}{2}$ "	2 $\frac{1}{2}$ " x 20"	405
211311	.50	4000	48 $\frac{1}{2}$ " x 41 $\frac{1}{2}$ " x 31 $\frac{1}{2}$ "	2 $\frac{1}{2}$ " x 30"	470
211321	.75	5000	56 $\frac{3}{4}$ " x 41 $\frac{1}{2}$ " x 35 $\frac{1}{2}$ "	2 $\frac{1}{2}$ " x 30"	575
211331	1.0	6000	62" x 41 $\frac{1}{2}$ " x 37"	2 $\frac{1}{2}$ " x 30"	620
211341	1.5	6000	62" x 59 $\frac{1}{2}$ " x 37"	2 $\frac{1}{2}$ " x 48"	785
211351	2.0	6000	64" x 59 $\frac{1}{2}$ " x 46"	2 $\frac{1}{2}$ " x 48"	880
211361	2.5	6000	64" x 59 $\frac{1}{2}$ " x 51"	2 $\frac{1}{2}$ " x 48"	905

Extra Heavy Duty Formed Base – 10 gauge, stackable

CAT. NO.	YARD CAPACITY	CAPACITY (LBS.)	L X W X H	FORK OPENINGS	LBS.
211531	1.0	4000	62" x 41 $\frac{1}{2}$ " x 37"	2 $\frac{1}{2}$ " x 30"	485
211541	1.5	4000	62" x 59 $\frac{1}{2}$ " x 37"	2 $\frac{1}{2}$ " x 48"	630
211551	2.0	4000	64" x 59 $\frac{1}{2}$ " x 46"	2 $\frac{1}{2}$ " x 48"	690
211561	2.5	4000	64" x 59 $\frac{1}{2}$ " x 51"	2 $\frac{1}{2}$ " x 48"	730

Heavy Duty Formed Base – 12 gauge, stackable when empty

CAT. NO.	YARD CAPACITY	CAPACITY (LBS.)	L X W X H	FORK OPENINGS	LBS.
211711	.5	2000	48 $\frac{1}{2}$ " x 41 $\frac{1}{2}$ " x 31 $\frac{1}{2}$ "	2 $\frac{1}{2}$ " x 30"	365
211731	1.0	2000	62" x 41 $\frac{1}{2}$ " x 37"	2 $\frac{1}{2}$ " x 30"	425
211741	1.5	2000	62" x 59 $\frac{1}{2}$ " x 37"	2 $\frac{1}{2}$ " x 48"	540
211751	2.0	2000	64" x 59 $\frac{1}{2}$ " x 46"	2 $\frac{1}{2}$ " x 48"	600
211761	2.5	2000	64" x 59 $\frac{1}{2}$ " x 51"	2 $\frac{1}{2}$ " x 48"	620

SHIPPING INFORMATION: 1 Week, F.O.B. Litchfield, MI



SHIPPING INFORMATION:
Stock to 10 Business Days, F.O.B. Lake City, MN
All Products Made in the U.S.A.

Product No.	Power Source	Capacity (cu.yd.)	Capacity (lbs.)
F89144	Forklift	1	2,000
F89143			4,000
F89142			6,000
F89141		2	2,000
F89140			4,000
F89139			6,000

Powered Self-Dumping Hoppers

- Secure unit to forklift.
- Connect to forklift auxiliary line using quick-connect couplers.
- Control unit ergonomically using convenient forklift controls.
- Start & stop at any point during dumping/retracting process.
- Quick 5 second cycle time.
- Leak-proof continuous solid welds.
- Secure unit to forklift with included safety chain.



F89141

Industrial Battery Chargers



V-HFM³ Series



HFM³ FS3



Features

- Modular design
- Reliable and redundant
- Multi voltage and multi amp hr
- Capable of Conventional, Opportunity, Fast or V-Force Lithium-ion profiles
- Lithium ready option
- Auto equalization by cycles or date/time
- Optional current sensing BMID available
- Downloadable event log - up to 10,000
- Marks of Conformity - UL Listed, cUL Listed, CEC-BC Compliant
- Mounting bracket included
- Warranty - 2 years full plus 1 year parts
- V-HFM³ FS6 - dual cable

Note: P.N. 300118-001 for USB cable

Note: For additional information, please reference the brochure and price pages available through your local Crown dealer or the Partner Site.



HFM³ FS4

BATTERY HANDLING

Model	FS3 Three Phase				FS4 Three Phase				FS6 Three Phase			
Battery Voltage Range	24V, 36V, 48V, 72V, 80V, 96V											
Main Voltage (Three Phase)	208 - 240Vac											
	380 - 480Vac				380 - 480Vac				380 - 480Vac			
	480 - 600Vac				480 - 600Vac				480 - 600Vac			
Module Configuration	One to Three Modules				Two to Six Modules				Two to Six Modules			
Efficiency	Up to 97%											
Battery Voltage vs. Charge Current (V)	24/36	48	72/80	96	24/36	48	72/80	96	24/36	48	72/80	96
Max Charging Current (A)	300A	255A	150A	127.5A	400A	400A	300A	255A	600A	510A	300A	255A
Dimensions (W x H x D)	12 x 9.5 x 14.5 in. (305 x 240 x 365 mm)				12 x 18.5 x 14.5 in. (305 x 470 x 365 mm)				12 x 18.5 x 14.5 in. (305 x 470 x 365 mm)			
Weight	Maximum 37.4 lbs. (17 kg)				Maximum 71.5 lbs. (32.5 kg)				Maximum 71.5 lbs. (32.5 kg)			
Marks of Conformity	UL listed, cUL Listed, CEC-BC Compliant											
Charge Profile Options	Conventional, Opportunity, Fast and V-Force Lithium-Ion available in FS3 and 4 Cabinets											

V-HFE³ Series

High-Frequency Economy Chargers



Features

- High efficiency = energy savings
- Compact and lightweight
- CE and RoHS Compliant - UL Listed
- Mounting bracket included with every charger
- Warranty - 2 year full plus 1 year parts
- Reporting capabilities
- Multiple DC voltage 24/36/48V
- Higher AC voltage range - up to 600V AC

Model Number	Cabinet Size	No. of Modules	Max Current	DC Voltage	Amp Hour Range Conventional	AC Input	Max Weight (lbs.)
FS2-MP342E-1	FS3	1	100	24 or 36	300 - 750	2088/240V	30
				48	300-650		
FS2-MP342E-2	FS3	2	200	24 or 36	300 - 1375	208/240V	34.2
				48	300 - 650		
FS2-MP344E-1	FS3	1	100	24 or 36	300 - 750	480V	30
				48	300 - 50		
FS2-MP344E-2	FS3	2	200	24 or 36	300 - 1375	480V	34.2
				48	300 - 650		
FS2-MP346E-1	FS3	1	100	24 or 36	300 - 750	600V	32.2
				48	300 - 650		
FS2-MP346E-2	FS3	2	200	24 or 36	300 - 1875	600V	30
				48	300 - 1575		

Cabinet Size FS3: 7.75" W x 15.15" D x 15.25" H

Note: For additional information, please reference the brochure and price pages available through your local Crown dealer or the Partner Site.

WARNING: Cancer and reproductive harm - www.P65Warnings.ca.gov

V-Force® Small Fleet Battery Management System

Take the guesswork out of selecting the properly charged battery

Properly charging, cooling, and load balancing your fleet's batteries can boost productivity and save money in the long run. This system easily identifies the next available battery for the operator when changing batteries, reducing swap times, and ensuring batteries are properly charged, cooled, and rotated.



INCREASE EFFICIENCY

Reduce the number of battery changes



IMPROVE BATTERY LONGEVITY

Increase battery life and gain more usage out of each battery due to longer cool down times



PROVIDE VISUAL CUES

Blue LED Sentinel Light signals to operators which batteries are cooled and fully charged



ENSURE ACCURACY

Audible alarm alerts operators when the incorrect battery is chosen during the battery swap



INSTALL EASILY

Daisy-chained data cable connections for quick install with standard tools



DEPLOY FLEXIBLY (OR UNIVERSALLY)

Manage up to 50 High Frequency, SCR and Ferro Resonant chargers in conventional battery changing applications for each battery type. Adjustable to pool battery voltage via internal jumper

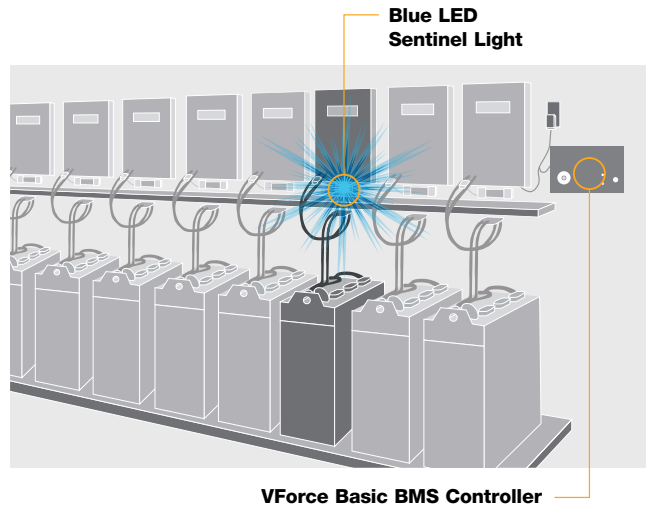

BATTERY HANDLING



**VForce Basic BMS Controller
Part No. 340640**

- Two 25' CAT 3 Sentinel data cables
- Power supply with multiple AC adapter tips
- One controller manages up to 50 chargers



**Blue LED Sentinel Light
Part No. 300314-SU6**

- One light per charger recommended
- Includes one 7' CAT 3 Sentinel data cable and couplers per light

For more details, contact your local Crown dealer or visit crown.com.



Battery Room Checklist

BATTERY HANDLING

Thank you for allowing me to conduct a survey of your current forklift battery charging and maintenance resources. The items noted below are products we recommend you consider adding or updating within your current charging area to help support proper battery maintenance, charging and safe handling. These products and many more parts and supplies can be found in the attached One Source Lift Truck Parts Catalog.

If you have any questions regarding these recommendations, or about placing an order with Crown Equipment, please contact me:

Name _____

Phone _____

Email _____

BATTERY SERVICE SUPPLIES

Part No.	Description
<input type="checkbox"/> 079528	Koorsen 2.5 lb. Fire Extinguisher, ABC*
<input type="checkbox"/> 365466	NuTend 16 Gallon Eye Wash Station*
<input type="checkbox"/> 365474	Water Additive, Case/12*
<input type="checkbox"/> 365468	ProWorks® Eye Wash Station, 1 kit*
<input type="checkbox"/> 365469-001	ProWorks® Replacement Bottle of Eye Wash*
<input type="checkbox"/> 300035	Battery Spill Kit*
<input type="checkbox"/> 365260-001	Apron, Black*
<input type="checkbox"/> 300042	Faceshield, Clear*
<input type="checkbox"/> 300041	Headgear*
<input type="checkbox"/> 300044	Acid Resistant Glove, Green*
<input type="checkbox"/> 300403-050	Reusable Battery Acid Floor and Counter Mat, 3 ft. x 50 ft.*
<input type="checkbox"/> 300421	Battery Protector® Acid Spill Absorber and Neutralizer, 5 gal.*
<input type="checkbox"/> 300421-030	Battery Protector® Acid Spill Absorber and Neutralizer, 30 gal.*
<input type="checkbox"/> 363124-001	Crown Battery Cleaner, 18 oz.
<input type="checkbox"/> 363125-001	Crown Battery Protector, 14 oz.
<input type="checkbox"/> 363133-001	QuickCable Black Battery Reconditioner, 12 oz.

*Strongly suggested per OSHA standards

CHARGER ACCESSORIES

Part No.	Description
<input type="checkbox"/> 169244-001	Rail Stop
<input type="checkbox"/> 396568	Magnet Mount Cable Holder
<input type="checkbox"/> 168175-001	Battery Pogo Stick, 39 in.
<input type="checkbox"/> 168284-001	Tender Kit
<input type="checkbox"/> 300460	Short L-Bracket for Racking
<input type="checkbox"/> 168283-001	Pogo Stick L Mounting Bracket
<input type="checkbox"/> 300038-005	Tool Balance Swivel Mount
<input type="checkbox"/> 396625-001	Retractor w/ Grommet
<input type="checkbox"/> 168176-002	HD Pogo Stick w/ Tender Kit

WATERING GUN

Part No.	Description
<input type="checkbox"/> 300236	V-Force® Battery Watering Gun

FLOAT SYSTEM - FILL OPTIONS

Part No.	Description
<input type="checkbox"/> 300224-147	120 V AC 10 Gallon Watering Cart
<input type="checkbox"/> 300224-090	120 V DC 10 Gallon Watering Cart
<input type="checkbox"/> 300226-005	V-Force® Water Deionizer

BATTERY ACID INDICATORS

Part No.	Description
<input type="checkbox"/> 340011-012	Smart Blinky Pro, 2.35 in.
<input type="checkbox"/> 340011-015	Smart Blinky Pro, 5 in.
<input type="checkbox"/> 340011-007	Blinky, 2.35 in.
<input type="checkbox"/> 340011-008	Blinky, 5 in.
<input type="checkbox"/> 340011-009	Smart Blinky, 2.35 in.
<input type="checkbox"/> 340011-010	Smart Blinky Remote, 2.35 in.
<input type="checkbox"/> 340011-011	Smart Blinky, 5 in.

BATTERY MANAGEMENT SYSTEM

Part No.	Description
<input type="checkbox"/> 340640	V-Force® Small Fleet BMS Controller
<input type="checkbox"/> 300314-SU6	Sentinel with Blue Light

SAFETY BOOTS

Part No.	Description
<input type="checkbox"/> 300413-050	V-Force® Safety Boot, SB, 50 A
<input type="checkbox"/> 300413-175	V-Force® Safety Boot, SB, 175 A
<input type="checkbox"/> 300413-350	V-Force® Safety Boot, SB, 350 A
<input type="checkbox"/> 300462-175	V-Force® Safety Boot, SBX, 175 A
<input type="checkbox"/> 300462-350	V-Force® Safety Boot, SBX, 350 A

Lead Acid Recommendation

FC PUF
(Back to Back)

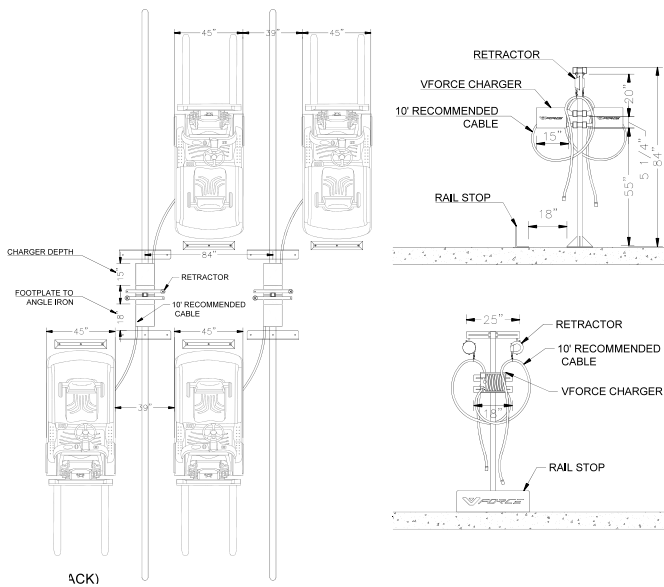

FC PUF
(Single)

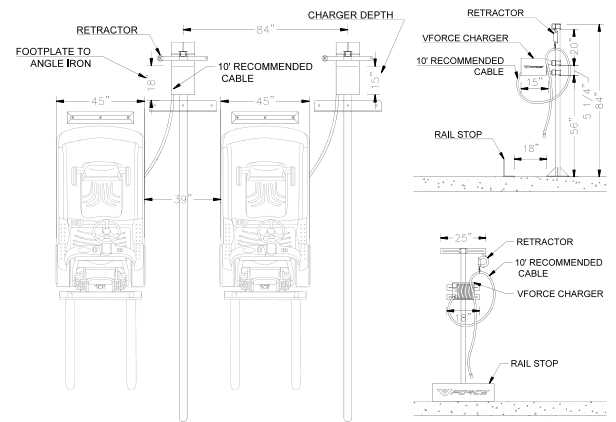

BATTERY HANDLING

Lithium Recommendation

FC PUF DIAGONAL
(Back to Back)

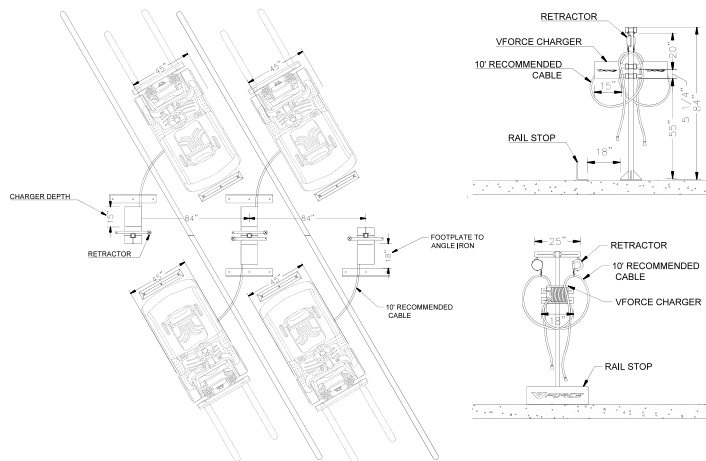

FC PUF DIAGNAL
(Single)

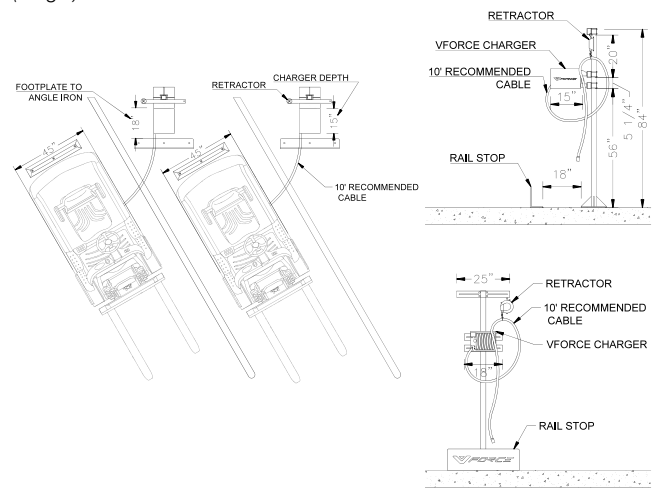

For more details, contact your local Crown dealer or visit crown.com.



Charger Stand

For use with V-HFM³, V-HFE and V-HFM

Features and Benefits

- Sleek versatile design offers multiple configuration options.
- Heavy duty steel frame construction.
- Stand securely anchors to the floor and holds chargers safely in place.
- Designed to free up valuable warehouse floor space.
- Uses mounting bracket included with charger.



Standard 55" Post

Standard 55" Post *Recommended for use with Lead Acid chargers only				
Description	Item Number	Side View	Maximum # Of Chargers	Top View
55" Post 25" Arm Single Sided	168383-055-25-1		UP TO 2	
55" Post 25" Arm Double Sided*	168383-055-25-2		UP TO 4	

*NOTE: FS3 cabinet only

Tall 84" Post

Tall 84" Post *Recommended for use with Lithium chargers, also available for Lead Acid chargers				
Description	Item Number	Side View	Maximum # Of Chargers	Top View
84" Post 25" Arm Single Sided	168383-084-25-1		UP TO 2	
84" Post 25" Arm Double Sided	168383-084-25-2		UP TO 4	

Charger Accessories

Tender 3 Hole Clamp with Clip

Part No.	Description
369500	Tender 3 Hole Clamp with Clip

⚠️ WARNING: Cancer and reproductive harm - www.P65Warnings.ca.gov

USB Cable 6'

Part No.	Description
300118-001	USB A to Micro-B 2.0 cable used to program V-HFM ³ Series High Frequency Chargers.
300118	USB A to MINI-B 2.0 cable used to program V-HFM Series High Frequency Chargers.

Charger Accessories

Battery Monitoring Identification Device (BMID)

Part Number - 396525-BTM

- Automatically programs V-Force V-HFM/V-HFM³ chargers with the correct battery charge profile.
- Dual profile configuration to optimize battery health and SOC for opportunity or fast charging.
- Records all battery events including temperature, charge and discharge cycles.
- Current sensing up to +/- 1300 amps.
- Electrolyte level sensor.
- Temperature probe senses battery temperature throughout the complete charge cycle and adjusts the charge profile as needed.



- Larger toroid to fit 4/0 cable.
- Rugged case construction resists impact, water, and battery electrolyte spills.
- Bluetooth[®] Class 1 for improved range when connecting to a laptop or tablet.
- UL Classified
- Installation kit included (P.N. 396525-KIT)

Replacement parts: Temperature Sensor - P.N. 396573; Installation Kit - P.N. 396525-KIT

Mounting Hardware

The **Mounting Bracket** is a convenient solution for mounting charger cabinets.

V-HFM³ Mounting Bracket

Part Number - 396583

- Heavy duty steel construction supports up to 50 lbs.
- Allows the FS3 charger cabinet to be mounted from the rear, side or to stand.
- Included with every HFM³ model charger.
- Frees up floor space and keeps charger secure to prevent damage.



396583



396583-001

Part Number - 396583-001

- Included with every HFM³ FS4/FS6 charger

V-HFM and V-HFE Mounting Bracket

Part Number - 396521-001

- Included with every HFM and HFE FS3 Cabinet



396521-001

WARNING: Cancer and reproductive harm - www.P65Warnings.ca.gov

Long L-Bracket is used in conjunction with a pogo stick to keep cables elevated and off the floor.



Part Number - 168283-001

- Use the longer L-bracket to mount to the wall next to the FS3 size cabinet charger.
- Can be used with both our standard and heavy duty pogo sticks.

Also available:

L-Bracket and Pogo Stick

P.N. 168176-001

L-Bracket with Heavy Duty Pogo Tender Kit

P.N. 168176-003

*Recommended for use with V-HFM³ FS3-3 models and larger.

L-Bracket includes hardware. Used to mount pogo stick to racking.

Part Number - 300460

WARNING: Cancer and reproductive harm - www.P65Warnings.ca.gov

Tower Light

Part Number - 396586-001



- HFM³ LED light indicates battery charge status from a distance.
- Includes 11.81 inch pole with mounting bracket, I/O expansion board with internal wiring loom, expansion board mounting standoff and DE9 mounting standoffs.

WARNING: Cancer and reproductive harm - www.P65Warnings.ca.gov

Remote Switch

Part No. Description

396587-001	Use with V-HFM ³ chargers that are mounted in a location not easy to access.
396555	Use with V-HFM chargers that are mounted in a location not easy to access.



396587-001

Replacement parts for Part No. 396587-001:

Remote control only - P.N. 396587

Remote control cable - P.N. 396587-002

396555



WARNING: Cancer and reproductive harm - www.P65Warnings.ca.gov

Battery Pogo Stick

Part No. Description

168175-001	Used to keep battery connectors and cables off the floor at charging stations, preventing damage and wear. 39" in length, 1" in diameter. Supports up to 10 ft of 3/0 cable.
------------	--



Replacement Rubber Grommet
P.N. 300038-001



WARNING: Cancer and reproductive harm - www.P65Warnings.ca.gov

Heavy Duty Battery Pogo Stick

Part No. Description

168175-002	Zinc plated 40". Up to 66% stronger than competitive designs. Mounting hardware included. Includes rubber grommet clamp. Recommended for HFM ³ .
------------	---



WARNING: Cancer and reproductive harm - www.P65Warnings.ca.gov

V-Force Cable Retractor

Part No. Description

396625	Cable Retractor
396625-001	Cable Retractor with Grommet/Cable Housing

396625

Balance DC charger cables or tools weighing up to 15 lbs. Spring tension adjusts easily.

396625-001



WARNING: Cancer and reproductive harm - www.P65Warnings.ca.gov

Swap out forklift batteries in minutes with industry-leading equipment from BHS, Inc. Visit BHS1.com to view our full product line.

Horizontal Battery Transfer (Roller)

OPERATOR ABOARD BATTERY EXTRACTORS

Any facility operating with a large fleet of electric forklifts will require frequent battery change-outs. BHS Operator Aboard Battery Extractors (BE) are essential for exchanging batteries from forklifts, and BHS offers a variety of BE models for operations of all sizes. BHS battery changers can reduce change-out times substantially, ensuring a more productive facility. For maximum efficiency and space-savings, BEs are also available in multi-level systems. BHS representatives will help determine which model is best for your application by considering fleet size, room dimensions, battery and charger specifications, budget requirements, and various other factors. **LEAD TIME: Consult Crown, F.O.B. St. Louis, MO**

Models custom built to YOUR specifications!



Double Stack Battery Extractor System

TRANSFER CARRIAGES

BHS manufactures exceptional battery handling equipment for lift truck fleets of any size. Our comprehensive line of battery carts & carriages provides an ideal solution for operations that conduct several battery change-outs per day. BHS' collection is highly customizable, with a wide range of options to meet your facility's battery handling needs.

LEAD TIME: Consult Crown, F.O.B. St. Louis, MO



BATTERY TRANSFER CARRIAGES

Available in 18", 24" & 30" compartment widths

Models:

- BTC-MPP** - Manual Extraction & Manual Lift
- BTC-MPPEE** - Manual Extraction & Powered Lift
- BTC-MPPEL** - Powered Extraction & Manual Lift
- BTC-MPPAE** - Powered Extraction & Powered Lift



AUTOMATIC TRANSFER CARRIAGES

(For use with existing pallet trucks.)

Available in 24", 30", 36", & 42" battery-compartment widths with either vacuum or magnetic extraction.

Models: Options:

- ATC-24** **ATC-BSELV** (Base elevations for higher roller compartment dimensions)
- ATC-30** **ATC-CAN** (Extended reach to reach beyond lift truck outriggers and other obstructions)
- ATC-36** **ATC-2TIER** (Ability to access a greater variety of roller heights of lift trucks)
- ATC-42** *Additional options available*



MOBILE BATTERY EXTRACTOR

Available with a 42" battery-compartment width with either vacuum or magnetic extraction.

Models:

- MBE-42**
- Options:**
- MBE-LA** (Lead Acid Battery)

BATTERY & CHARGER STANDS

BHS Battery Roller Stands provide convenient storage for industrial lift truck batteries. Constructed with heavy-duty steel, these stands are available in various compartment widths and compartment sizes to meet specific requirements. **LEAD TIME: 2 weeks to ship, F.O.B. St. Louis, MO**

2-COMPARTMENT STANDS

Model	Roller Width (Ea.)	LB
BS12-2	12"	215
BS15-2	15"	202
BS18-2	18"	228
BS21-2	21"	250
BS24-2	24"	300
BS27-2	27"	360
BS30-2	30"	415
BS33-2	33"	445



3-COMPARTMENT STANDS

Model	Roller Width (Ea.)	LB
BS12-3	12"	270
BS15-3	15"	289
BS18-3	18"	353
BS21-3	21"	416
BS24-3	24"	460
BS27-3	27"	530
BS30-3	30"	575
BS33-3	33"	640



WARNING: Cancer and reproductive harm - www.P65Warnings.ca.gov

Vertical Battery Transfer

HARDWOOD BATTERY STATIONS

Hardwood Battery Stations are an ideal battery storage solution for Gantry Crane and other overhead extraction applications. These rugged stations have a heavy-duty frame and a powder-coat finished for added durability. The recycled polyethylene decking is acid-resistant, nonconductive, and environmentally friendly. A charger shelf comes standard on all models. Available in 30", 42", 60", 72", 84", 96", 108", 120", and 144" widths.

Model	Width	LB
HBS-30	30"	200
HBS-42	42"	242
HBS-60	60"	322
HBS-84	84"	470
HBS-96	96"	512

If charger shelf is not required, use suffix -1.
If wood sideways are required, use suffix -WS.

WARNING: Cancer and reproductive harm - www.P65Warnings.ca.gov

BATTERY LIFTING BEAMS

Designed for integration with gantry crane systems or can be used in conjunction with a BHS Fork Attachment and Forklift, for completing a safe and efficient solution for vertical-extraction battery handling applications.

Model	Capacity (LB)	LB
BLB-6000	6,000	58

WARNING: Cancer and reproductive harm - www.P65Warnings.ca.gov

FORK ATTACHMENTS

Fork Attachments slide easily and securely onto lift truck forks to give trucks the ability to handle heavy loads with overhead, single-point lift designs. This low-cost, high-value solution is ideal from maintenance tasks on vertical-extraction forklift battery fleets.

Model	Capacity (LB)	LB
FA-2.5	2,500	8
FA-6	6,000	26

WARNING: Cancer and reproductive harm - www.P65Warnings.ca.gov

LEAD TIME: 2 Weeks to ship, F.O.B. St. Louis, MO



BATTERY HANDLING

Battery Watering Application Chart

Use the following table to help determine the best system for the application at hand. Not all applications are alike; be sure to put the appropriate product into the correct application to ensure years of cost effective & reliable operation.

Product	Watering Gun	Float System	Spider Injector System
Facility Size	1-5 batteries	5-25 batteries	25 or more batteries
Application	Light Duty Small Facility Infrequent Use Golf Course	Medium Duty Low Water Pressure Medium Facility	Heavy Duty Abusive Conditions Rapid Charge Battery Chargers
Time to Install	Not Applicable	12 Minutes	3 Minutes
Time to Fill an 18-Cell Battery	20 Minutes	2-10 Minutes	15 Seconds
Payback/ROI	\$	\$\$	\$\$\$

V-Force® Barbed Watering Float System Kits



V-Force Barbed Valve Battery Watering Float Systems make the watering of your industrial batteries faster and safer. You will need two components: a water supply (found throughout the One Source Catalog) and one of the part numbers found below. If you have a Philadelphia Scientific Water Supply, you can order a V-Force Float System (e.g. 300316-012-INJ) to replace your existing Stealth Kit or an Injector Kit.

The process is simple. First, identify the manufacturer of your water supply (e.g. Philadelphia Scientific, Battery Filling Systems (BFS), Battery Watering Technologies (BWT), V-Force, or Flow Rite). Then, identify the battery manufacturer; Douglas batteries will require a DIN adapter, which is included. Next, determine the battery voltage (24V, 36V, 48V). The final step is to select the watering system from the table below. The adapters shown are included so you can connect the kit you choose to your water supply.

Voltage	CPC 3/4" input Brands used with Crown V-Force (most common), Philadelphia Scientific Stealth and Flow-Rite. Select a system below.	CPC 1/2" input (used primarily with BWT (Battery Watering Technologies). Select a system below.	BFS input (used primarily with BWT (Battery Watering Technologies). Select a system below.	Quick Connect Input Brands used with are Philadelphia Scientific Water Injector and Water Injector Spider. Select a system below.
12V	300316-006	300316-006-BWT	300316-006-BFS	300316-006-INJ
24V	300316-012	300316-012-BWT	300316-012-BFS	300316-012-INJ
36V	300316-018	300316-018-BWT	300316-018-BFS	300316-018-INJ
48V	300316-024	300316-024-BWT	300316-024-BFS	300316-024-INJ
72V	300316-036	300316-036-BWT	300316-036-BFS	300316-036-INJ
80V	300316-040	300316-040-BWT	300316-040-BFS	300316-040-INJ

Douglas Batteries (DIN vent openings): 24V-300316-012-01, 36V-300316-018-01, 48V-300316-024-01, 80V-300316-040-01

NOTE: Tubing cutter P.N. 3003227-allation tool and P.N. 300310-022 are helpful for installation of V-Force Float Watering Systems.

NOTE: V-Force watering kits installed from the factory on V-Force lead-acid batteries (Part# ending with -INS or -INP) use the same components as the kits above.

V-Force Barbed Watering Float Valve & System Components



Barbed Valve Option

300316-007

Highly Visible Fill Level Indicator
Viewable from top and side

"One Size Fits All"
• Fills all cells to appropriate level
• Multiple float sizes not needed

Barbed Fittings
Clampless Barbed Fittings
make it easy to secure tubing

Snap-Fit Base
No separate
adapter required



Rotatable Base
Once installed

"One Size Fits"
• Fills all cells to
• Multiple float

Built-in Float Guard



V-Force Battery Watering System Components

Barbed Watering Kit Components

Component Part Number	Component Description
300316-007	V-Force Barbed Valve
300316-002-XX	V-Force Barbed Tubing
300316-001	End Plugs For V-Force Barbed Watering
300316-004	Std Barbed Input Assembly V-Force

Standard Watering Kit Components

Component Part Number	Component Description
300225-001	V-Force Float Assembly
300220-072-XX	V-Force Universal Tubing
300220-029	End Plugs for V-Force Watering
300220-083	Input Assembly V-Force

Additional Watering Kit Components

Component Part Number	Component Description
300227-015	BFS Adapter
300227-031	BWT Adapter
300227-014	Flow-Rite Adapter
300310-008	Injector Tubing - 1/2" OD, 25'
300310-018	Injector Tubing - 1/2" OD, 500'

Battery Watering — Float System

Direct Fill Link

Designed to attach to in-house plumbing. Water pressure may not exceed 80 PSI. Do not fill from a faucet.

CAT. NO. 300222



12v 10 Gallon Watering Cart

- Easy to transport to remote locations
- Easy to fill; large opening
- Charge the battery operated unit from any 120 VAC outlet with the provided charger
- Sturdy 10-gallon polypropylene tank
- 9 ft hose
- On/off switch on rear of unit
- Easy to use; instructions printed on the unit

CAT. NO.	AC/DC
300224-147	AC
300224-090	DC



5 Gallon Gravity Flow Tank-Hose

- Sturdy 5-gallon polypropylene tank
- Easy to fill
- Flow indicator
- 25 ft. hose attaches with a rugged connector
- Note: Unit needs to be mounted at least 5 feet above the top of the battery.

CAT. NO. 300223



Pressure Tank Watering Cart

- Sturdy 10 gallon (38.9 liter) steel tank
- Capacity gauge indicates how full the tank is
- No battery or electricity required — uses your building's water pressure to deliver water wherever you need it
- 9 ft. (2.7 m) of industrial input hose; 10 ft. (3 m) of industrial output hose

CAT. NO. 300234-003



Shelf For Float System Gravity Tank

- Wall-mountable shelf to hold 5-gallon gravity tank shown above
- 100 lb capacity

CAT. NO. 300223-002



Output Hose with Quick-Connect

- 10 ft. (3 m) of industrial output hose with quick-connect

CAT. NO. 300234-002



Water Deionizer

- Comes with everything you need to make pure water from the tap
- Operates at full-line pressure to dispense pure water directly from the deionizer
- Quick cartridge replacement requires no tools
- 20-ft output hose allows maximum watering flexibility and convenience
- Optional Watering Gun lets you fill a battery directly from the deionizer

CAT. NO. 300226 -005

WARNING: Cancer - www.P65Warnings.ca.gov



Battery Watering Gun

- Ergonomically Designed
- Easy-squeeze, rugged handle
 - 45° bend nozzle
 - Less bending over to fill battery

Superior Strength

- Built from rugged, engineered ABS plastic
- Weak points eliminated; pressure regulator incorporated into nozzle

Flow Diffuser

- Converts the rapid flow to a gentle spray
- Protects nozzle from damage

Secure Level Control

- Will not move over time
- Adjustable or removable
- Pre-set for optimum level for most motive power batteries
- Beveled to conform to vent well at many angles

Faster Fill

- 1.7 GPM
- Spend less time watering

CAT. NO. 300236



Battery Watering — Spider Injector System

Water Injector System

• **Very Fast Operation:** An average industrial truck battery can be filled, with precise level control, in less than 15 seconds. The savings in labor costs alone often pays for the system within its first year of operation.

• **Quality of Watering:** It extends the life of each expensive battery it is installed on due to improved quality of watering. The battery is properly watered every time.

• **Safety and Environmental Cleanliness:** There is no need to peer into cells to inspect levels as with manual filling. Spider Injector Watering Systems automatically fill each cell to the correct level, so no overfilling and no electrolyte overflow during charge.

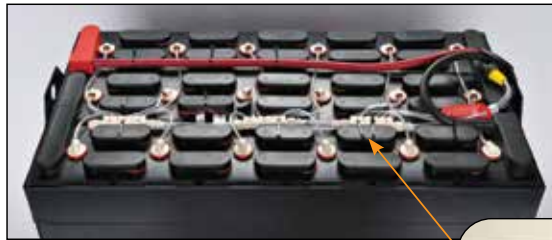

- No-Freeze Tubing
- 2-Stage Filtration
- Easy Installation
- 5-Year Warranty

CAT. NO.	DESCRIPTION
300302-012	24V Spider Injector Kit Standard
300302-018	36V Spider Injector Kit Standard
300302-024	48V Spider Injector Kit Standard
300309-012	24V Spider Injector Kit w/DIN Adapter
300309-018	36V Spider Injector Kit w/DIN Adapter
300309-024	48V Spider Injector Kit w/DIN Adapter

BATTERY HANDLING

Direct Fill Hose Injector

The Direct Fill Hose Injector requires a minimum of 25 psi of flowing water at a rate of 8 gallons per minute. If the flow is inadequate, the Injectors will not shut off. If a factory authorized water supply is not being used, water pressure from the wall must be confirmed with a 300310-027 Water Flow Pressure Measurement Tool.



CAT. NO.	LENGTH
300305	20'

Mini Hydro Cart Injector

- 10 gallon polypropylene tank
- 23 ft of total reach
- Easy to transport to remote locations
- Plug into 110 VAC outlet

CAT. NO. 300303



Hydro Cart Injector

- Sturdy 20 gallon polypropylene tank
- 30 ft of total reach, 15-ft power cord plus 15 ft of 3/8" high-output industrial hose
- Handles like a hand truck
- On/off switch and power indicator located on front of unit
- Plug into 110 VAC outlet
- Flow indicator tells when the injectors have shut off

CAT. NO. 300302



Bladder Tank 10 Gallon

- 10 gallon steel tank
- Requires no power

Tank capacities based on input pressure

Input Pressure	Tank Capacity
80 PSI	10 Gallon
70 PSI	9.5 Gallon
60 PSI	8 Gallon
50 PSI	6 Gallon

Note: Water pressure below 50 PSI will require a booster pump.

CAT. NO. 300306



Battery Acid Indicators

Blinky

Blinky Basic option is a low-cost solution for accurate electrolyte monitoring. The new LED is twice as bright as the previous model and the housing is more robust. LED blinks green when the electrolyte level is good and goes out when water is required.



CAT. NO.	PROBE LENGTH
340011-007	2.35"
340011-008	5"

Smart Blinky

Ideal for batteries where the top of the battery can be seen. The new LED is 8 times brighter than the previous model. The electrolyte probe and LED are integrated into the same housing. The LED blinks green when the electrolyte level is good and blinks red when water is needed. The new design has an "installation forgiveness zone!" This system works on 6V and 12V block and golf cart batteries.



CAT. NO.	PROBE LENGTH
340011-009	2.35"
340011-011	5"

Smart Blinky Remote

Ideal for batteries that do not leave the truck or batteries that are changed on multi-level racks because the indicator LED can be edge mounted for high visibility. The new LED is 6 times brighter than the previous model. The LED housing has a lower profile and is more robust. The LED blinks green when the electrolyte level is good and blinks red when water is needed. The new design has an "installation forgiveness zone!" This system works on 6V and 12V block and golf cart batteries.



CAT. NO.	PROBE LENGTH
340011-010	2.35"

Smart Blinky Pro

Intelligent battery monitoring with both light and sound. SmartBlinky Pro provides a bright electrolyte level indicator to know when to fill a battery. The LED is mounted on the battery cable near the connector for maximum visibility - perfect for opportunity and fast applications in which the battery never leaves the truck. SmartBlinky Pro is rugged, built to withstand the harsh environment of industrial battery applications, and UL classified.



Safety Equipment & Accessories

Chevrons Floor Tape

Floor tape, Chevrons, 100 ft. roll, 2 in., Yellow/Black.

CAT. NO. 351097-044



16 Gallon Eye Wash Station

Size: 20.5" length, 18" width, 20.5" height. 15 minute flow, required by ANSI Z358.1-2009. Includes steel wall bracket, 2 oz. sterile water solution, and test log and drainage hose.

CAT. NO. 365466



Water Additive

Add to water for 16 gallon eye wash station to eliminate contamination from stagnant water. 8 oz. per 16 gallon refill.

CAT. NO. 365474



Eye Wash Station

Two bottle wall-mounted eye wash station. Includes two 16 oz. bottles of sterile eye wash. Easily mounts to any wall.

CAT. NO. 365468



Replacement Bottle of Eye Wash

Sterile eye wash. Can be used alone or with 365468 eyewash station.

CAT. NO. 365469-001



Battery Spill Kit

Includes: 1 faceshield; 1 headgear; 2 bottles of 32 oz. acid neutralizer; 10 acid spill absorbent cleanup pads; 1 yellow heavy-duty chemical disposal bag - 33" x 39"; 1 mini broom; 1 bottle of 16 oz. eye wash flush; 1 pair of green acid resistant nitrile gloves; 1 pair of acid-resistant sleeves; 1 pair of acid-resistant rubber overboots; 1 acid-resistant apron; 1 bucket.

CAT. NO. 300035



BATTERY HANDLING



Gemini

- Convertible 2-in-1 hand truck.
- Converts from 2 to 4 wheels in seconds.
- Lightweight aluminum reduces user fatigue.
- Optional build accessories available to meet all delivery needs.

Hand Trucks

- 500 lb. capacity.
- Magliner hand trucks are made with aluminum components for the highest strength-to-weight ration in the industry. Lightweight trucks put less strain on users, reduce user fatigue, and lead to fewer injuries - and that means increased productivity. Plus, lightweight hand trucks are easier to lift and store on delivery vehicles.
- By customizing hand trucks, users can greatly reduce the effort involved to move loads and improve safety. Mix and match parts from the modular component system for the customized hand truck to meet your needs.

Custom options are available to be built for your specific application. Over 1000 configurations are possible. Call for pricing.

Brake Trucks

Magliner brake trucks are designed specifically to make your deliveries easier and safer.

- Brakes can be safely activated with one hand for maximum load control.
- Provides safer load control on ramps and inclines.
- Manages speed from a gradual stop.
- Modular, lightweight aluminum design permits rapid repair of hand trucks and reduces driver down time.



Truck becomes a functional platform truck capable of moving up to 1000 lbs.

A. Gemini® Convertible Hand Trucks

- 10½" platform height from floor
- 18" x 7½" aluminum nose plate
- 10" x 3½" pneumatic 1060 hand truck wheels
- 5" x 1¼" swivel casters

CAT NO.	DESCRIPTION	HEIGHT AS HAND TRUCK	BED LENGTH AS PLATFORM	CAPACITY LBS.	WEIGHT LBS.
GMK16UA4	Gemini® JR.	51"	38"	1000*	44
GMK81UA4	Gemini® SR.	61"	51"	1000*	45

*500 lb capacity as a hand truck

All hand trucks reflect a knockdown price. For assembled hand truck, please contact your Crown Representative.



B.

B. Vertical Loop Handle

Aluminum 18" x 7½" nose plate

CAT NO.	DESCRIPTION
115-UA-0815	8" Mold-on rubber
115-UA-1010	10" Microcellular foam
115-UA-1060	10" Full pneumatic



C.

C. Standard "U" Handle

Aluminum 14" x 7½" nose plate

CAT NO.	DESCRIPTION
111-AA-0815	8" Mold-on rubber
111-AA-1010	10" Microcellular foam
111-AA-1060	10" Full pneumatic



D.

D. Double Grip Handle

Aluminum 14" x 7½" nose plate with optional stair climber

CAT NO.	DESCRIPTION
116-AA-0815-C5	8" Mold-on rubber
116-AA-1010-C5	10" Microcellular foam
116-AA-1060-CR5	10" Full pneumatic



E.

E. Single Grip Handle

Aluminum 18" x 7½" nose plate with optional stair climber

CAT NO.	DESCRIPTION
117-G1-0815-C5	8" Mold-on rubber
117-G1-1010-C5	10" Microcellular foam
117-G1-1060-CR5	10" Full pneumatic



F.



G.

All hand trucks reflect a knockdown price. For assembled hand truck, please contact your Crown Representative.

F. Double Pistol Grip Brake Truck

Y-cable brake truck with flared double pistol grip handle, 18" x 9" extruded aluminum nose plate, 10" pneumatic wheels, die cast aluminum stair climbers with wear strips, 55" Hi-U frame extension, double grip brake handle (assembled). **CAT. NO. NPA116-G2-45G-V**

G. Loop Handle Brake Truck

Y-cable brake truck with U loop handle with vinyl sleeve and U brace, 18" x 9" extruded aluminum nose plate, 10" pneumatic wheels, die cast aluminum stair climbers with wear strips, 60" Hi-U frame extension, U loop brake handle (assembled). **CAT. NO. NPA122-G2-45C**



A.



B.



C.

A. 170 Model

Powered stair climbing hand truck with curved back frame to accommodate cylindrical and flat loads, ergo handle, 18.8" x 9.4" aluminum nose plate, 10" pneumatic wheels. 375 lbs. capacity.

B. 140 Model

Powered stair climbing hand truck with curved back frame to accommodate cylindrical and flat loads, uni handle, 14" x 7" aluminum nose plate, 10" pneumatic wheels. 300 lbs. capacity.

C. HD Model

Heavy duty powered stair climbing hand truck with step-edge brake system, multiple ascend/descend modes, 10" solid wheels. 725 lbs. capacity.

CAT NO.	DESCRIPTION	OVERALL HEIGHT	BATTERY CAPACITY APPROX. STEPS (MAX LOAD)	WEIGHT CAPACITY LBS.	WEIGHT LBS.
CLK170EGS4	Ergo handle, 10" pneumatic wheels	62"	220 steps	375	44
CLK140UWL4	Uni handle, 10" pneumatic wheels	60"	220 steps	300	44
HDL360U	HD Model, Uni Handle, 10" solid wheels	64"	220 steps	725	75



D.



E.

D. Handle-Mounted Release

Appliance truck with 60" frame, dual shepherd handle, 23" x 5.32" coated extruded aluminum nose plate, 10" interlocked microcellular foam wheels, stair crawlers, 4th wheel attachment with handle release lever, wings with rubber bumper, break back bar, 2" x 12' self-retracting strap.

CAT. NO. HDARB5CM1EC11RLR

E. Frame-Mounted Release

Appliance truck with 60" frame, adjustable vertical loop handle, 23" x 5.32" extruded aluminum nose plate, 10" interlocked microcellular foam wheels, 4th wheel attachment with frame release cable, wings, break back bar.

CAT. NO. HDARB1CM2E-12WL

CAT NO.	DESCRIPTION	OVERALL HEIGHT	CAPACITY LBS.	WEIGHT LBS.
HDARBF5CM1EC11RLR	Handle-mounted release	66 ⁵ / ₈ "	800*	70
HDARB1CM2E-12WL	Frame-mounted release	66 ⁵ / ₈ "	800*	68

*600 lb. capacity in 2-wheel position



F.

F. Pallet Dolly

Pallet dolly compatible with all pallet systems: wood - metal - plastic - slip sheet. All pallet dollies come standard with 3-1/2" non-marking phenolic rollers with sealed, low maintenance bearings. Choose between non-tilt or tilt design to enable turning.

SHIPPING INFORMATION: 3 Days, F.O.B. Standish, MI

CAT NO. (NON-TILT)	CAT NO. (TILT)	WIDTH	LENGTH	NO. OF ROLLERS	WEIGHT CAPACITY LBS. PHENOLIC/TPU (NON-TILT MODELS)	WEIGHT CAPACITY LBS. PHENOLIC/TPU (TILT MODELS)	WEIGHT LBS.
PDN363606	PDT363606	36"	36"	6	4000 / 3000	3600 / 2000	30
PDN424206	PDT424206	42"	42"	6	4000 / 3000	3600 / 2000	34
PDN484806	PDT484806	48"	48"	6	4000 / 3000	3600 / 2000	36
PDN363608	PDT363608	36"	36"	8	6000 / 4000	5400 / 3000	37
PDN424208	PDT424208	42"	42"	8	6000 / 4000	5400 / 3000	39
PDN484808	PDT484808	48"	48"	8	6000 / 4000	5400 / 3000	43
PDN363610	PDT363610	36"	36"	10	8000 / 5000	7200 / 4000	42
PDN424210	PDT424210	42"	42"	10	8000 / 5000	7200 / 4000	44
PDN484810	PDT484810	48"	48"	10	8000 / 5000	7200 / 4000	47



Powered Stair Climbing Hand Truck

- Lightweight aluminum construction and ergonomic design promote proper posture and reduce awkward movements by operator.
- Takes only 1.5 hours to charge a totally discharged battery to 90%.
- Power assist in climbing and descending modes.

Appliance Trucks

- Easily move heavy or bulky items up and down stairs.
- Lightweight aluminum makes load handling easier.
- Break back bar prevents the truck from rolling when breaking back or uprighting loads.
- Appliance Trucks ship fully assembled.

Pallet Dollies

- Don't wait for a forklift! Pallet dollies provide easy access to any pallet load, increases safety and productivity.
- Heavy-duty aluminum channel frame construction.
 - Rounded corners for safety.
 - Steel hexagonal axles interlock with frame to prevent rotation.
 - Optional floor brake available.
 - Tow hitch option available (requires tilt model and TPU rollers).



HAND TRUCKS & CARTS

A.



Industrial Strength Hand Trucks

A. T-132 Series Continuous Handle, 47" H

CAT. NO.	WHEEL DESCRIPTION	CAPACITY (LBS.)	LBS.
T-132-10	10" x 2.75" Solid Rubber Tire	800	37
T-132-10P	10" x 3.50" Pneumatic	800	35

WARNING: Cancer and reproductive harm - www.P65Warnings.ca.gov

B.



B. T-320 Series Dual Handle, 49" H

CAT. NO.	WHEEL DESCRIPTION	CAPACITY (LBS.)	LBS.
T-320-10	10" x 2.75" Solid Rubber Tire	800	37
T-320-10P	10" x 3.50" Pneumatic	800	35

WARNING: Cancer and reproductive harm - www.P65Warnings.ca.gov

C.



C. T-182 Series Loop Handle, 49" H

CAT. NO.	WHEEL DESCRIPTION	CAPACITY (LBS.)	LBS.
T-182-10	10" x 2.75" Solid Rubber Tire	800	39
T-182-10P	10" x 3.50" Pneumatic	800	37

WARNING: Cancer and reproductive harm - www.P65Warnings.ca.gov



Industrial Strength Hand Trucks

- 8" D x 14" W noseplate
- Four curved ribs with vertical center strap
- Heavy 1.05" tubular steel for added strength to frame and stair glides
- Extra high 29" stair glides provide rigidity and longer frame life
- Zinc-plated "D" axle is interchangeable in tri-hole axle bracket

Reinforced Nose Trucks

- 12" D x 14" W reinforced noseplate safely handles larger, bulky loads
- 10-year guaranteed noseplate
- Four curved ribs with vertical center strap
- Heavy 1.05" tubular steel for added strength to frame and stair glides
- Extra high 29" stair glides provide rigidity and longer frame life
- Zinc-plated "D" axle is interchangeable in tri-hole axle bracket

SHIPPING INFORMATION:
1 Week, F.O.B. University Park, IL



Industrial Strength Hand Trucks

- 1¼" tubular steel frame robotically welded
- ¼" high strength base plate with machine beveled edge to slide under the load easier
- Stair glides ease loads up or down stairs and over curbs
- 5/8" "D-Lok" zinc plated axle to resist rust
- 10" solid rubber or pneumatic wheels
- Color: dark green

SHIPPING INFORMATION:
1 Week, F.O.B. Wichita, KS

A. Model 20T16/60

CAT. NO.	WHEEL DESCRIPTION	CAPACITY (LBS.)	FRAME SIZE		BASEPLATE	LBS.
			H X W			
20T16	10" x 3½" pneumatic	800	50" x 20"		8" x 14"	36
20T60	10" x 2½" solid rubber tire	800	50" x 20"		8" x 14"	39

B. Model 30T16/60

CAT. NO.	WHEEL DESCRIPTION	CAPACITY (LBS.)	FRAME SIZE		BASEPLATE	LBS.
			H X W			
30T16	10" x 3½" pneumatic	800	50" x 22"		8" x 14"	35
30T60	10" x 2½" solid rubber tire	800	50" x 22"		8" x 14"	39

C. Model 56T16/60

CAT. NO.	WHEEL DESCRIPTION	CAPACITY (LBS.)	FRAME SIZE		BASEPLATE	LBS.
			H X W			
56T16	10" x 3½" pneumatic	800	50" x 20"		8" x 14"	36
56T60	10" x 2½" solid rubber tire	800	50" x 20"		8" x 14"	40

D. Model 40T16/60

CAT. NO.	WHEEL DESCRIPTION	CAPACITY (LBS.)	FRAME SIZE		BASEPLATE	LBS.
			H X W			
40T16	10" x 3½" pneumatic	800	50" x 18"		8" x 14"	36
40T60	10" x 2½" solid rubber tire	800	50" x 18"		8" x 14"	39

E. Model 46T16/60

CAT. NO.	WHEEL DESCRIPTION	CAPACITY (LBS.)	FRAME SIZE		BASEPLATE	LBS.
			H X W			
46T16	10" x 3½" pneumatic	800	45" x 20"		8" x 14"	36
46T60	10" x 2½" solid rubber tire	800	45" x 20"		8" x 14"	40

F. Model 35T86/16

CAT. NO.	WHEEL DESCRIPTION	CAPACITY (LBS.)	FRAME SIZE		BASEPLATE	LBS.
			H X W			
35T86	10" x 2½" solid rubber tire	800	56" x 18"		8" x 14"	39
35T16	10" x 3½" pneumatic	800	56" x 18"		8" x 14"	36

G. Model CTD14/86/16

CAT. NO.	WHEEL DESCRIPTION	CAPACITY (LBS.)	FRAME SIZE		BASEPLATE	LBS.
			H X W			
CTD14	8" x 2¼" solid rubber tire	600	56" x 17"		8" x 14"	35
CTD86	10" x 2½" solid rubber tire	600	56" x 17"		8" x 14"	38
CTD16	10" x 3½" pneumatic	600	56" x 17"		8" x 14"	36

H. Model HDTT16048A Convertible

CAT. NO.	WHEEL DESCRIPTION	CAPACITY (LBS.)	FRAME SIZE		PLATFORM	LBS.
			H X W			
HDTT16048A	10" x 2½" solid rubber tire	500-800	52" x 20"		13" x 41"	53



I. Model HDTT11648A Convertible

CAT. NO.	WHEEL DESCRIPTION	CAPACITY (LBS.)	FRAME SIZE		PLATFORM	LBS.
			H X W			
HDTT11648A	10" x 3½" pneumatic	800-800	60" x 22"		13" x 51"	56



J. Model DCT1446 Convertible

CAT. NO.	WHEEL DESCRIPTION	CAPACITY (LBS.)	FRAME SIZE		PLATFORM	LBS.
			H X W			
DCT1446	8" x 2¼" solid rubber tire	800-800	51" x 19"		18" x 49"	64



HAND TRUCKS & CARTS

Mobile Security Unit

The Security cart features quality construction. Keep valuable items such as meats, liquor, silver, pharmaceuticals, syringes and expensive tools secure and at the same time be able to transport them throughout your facility.

Enclosed Wire Shelf Truck

Complete truck consists of four shelves, four posts, side and back panels and swivel casters. Chrome finish panels keep contents securely on shelves and creates an enclosed storage environment. Includes joining clips to secure panels to each other.

Fold Up Security Truck

Help protect inventory from theft and damage with this completely enclosed truck. Open construction reduces dust accumulation and increases visibility. Fold to 6" for compact storage. Heavy gauge 1" x 2" wire mesh. 1" square tubing covered with 20 gauge sheet metal. Solid center shelf divides truck into two 34" H compartments and increases strength of the unit. 2000 lb. capacity.

SHIPPING INFORMATION:

- Northeastern:**
Robbinsville, NJ, 2 days;
- Southeastern:**
Buford, GA, 2 days;
- Midwest:**
Pleasant Prairie, WI, 2 days;
- Western:**
North Las Vegas, NV, 2 days.

A. Shelf

Unique design offers high volume, easy access storage in chrome and silver finish. Open wire truss reinforced shelves feature front to back welded surface ribs for added strength. Increases light penetration, free air circulation and merchandise visibility. Minimizes moisture and dust accumulation. Easily adjustable and expandable to change with your needs. Shelves adjust on 1" increments.

SIZE	LBS.	CHROME FINISH		SILVER FINISH	
		CAT. NO.	NET EA.	CAT. NO.	NET EA.
18" x 24"	7	S1824C	\$18.14	S1824EP	\$15.12
18" x 30"	8	S1830C	\$19.44	S1830EP	\$15.98
18" x 36"	9.5	S1836C	\$20.74	S1836EP	\$17.28
18" x 42"	11	S1842C	\$24.62	S1842EP	\$19.87
18" x 48"	12	S1848C	\$27.22	S1848EP	\$22.46
18" x 54"	14.5	S1854C	\$30.67	S1854EP	\$25.92
18" x 60"	17	S1860C	\$31.97	S1860EP	\$26.35
18" x 72"	20	S1872C	\$36.72	S1872EP	\$31.10
24" x 24"	9	S2424C	\$23.76	S2424EP	\$19.01
24" x 30"	11	S2430C	\$25.49	S2430EP	\$20.30
24" x 36"	13	S2436C	\$26.78	S2436EP	\$22.46
24" x 42"	15	S2442C	\$30.24	S2442EP	\$25.06
24" x 48"	19	S2448C	\$32.40	S2448EP	\$26.78
24" x 54"	19	S2454C	\$36.72	S2454EP	\$31.10
24" x 60"	21	S2460C	\$39.74	S2460EP	\$33.70
24" x 72"	26	S2472C	\$47.09	S2472EP	\$39.31
30" x 36"	16	S3036C	\$37.58	S3036EP	\$31.54
30" x 48"	20	S3048C	\$44.50	S3048EP	\$37.15
30" x 60"	24	S3060C	\$48.82	S3060EP	\$40.61
30" x 72"	28	S3072C	\$58.75	S3072EP	\$48.82
36" x 36"	17.5	S3636C	\$43.20	S3636EP	\$35.86
36" x 48"	22	S3648C	\$49.68	S3648EP	\$41.04
36" x 60"	26.5	S3660C	\$57.89	S3660EP	\$47.95
36" x 72"	31	S3672C	\$69.12	S3672EP	\$57.46

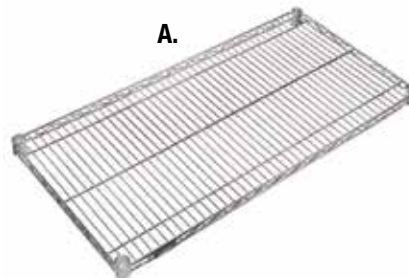

B. Mobile Security Unit - Chrome Finish

CAT. NO.	SIZE		LBS.	NET EA.
	W	X L X H		
STS1836C	18"	x 36" x 69"	169	\$455.70
STS1848C	18"	x 48" x 69"	194	\$530.49
STS2436C	24"	x 36" x 69"	174	\$522.18
STS2448C	24"	x 48" x 69"	201	\$583.13
STS2460C	24"	x 60" x 69"	239	\$653.77



C. Enclosed Wire Shelf Truck - Chrome Finish

CAT. NO.	SIZE		LBS.	NET EA.
	W	X L X H		
EPC1836PC	18"	x 36" x 69"	86.3	\$246.55
EPC1848PC	18"	x 48" x 69"	107	\$291.33
EPC1860PC	18"	x 60" x 69"	122	\$317.19
EPC2436PC	24"	x 36" x 69"	94	\$277.94
EPC2448PC	24"	x 48" x 69"	115.5	\$319.03
EPC2460PC	24"	x 60" x 69"	132	\$355.97



D. Fold Up Security Truck

CAT. NO.	SIZE		LBS.	NET EA.
	W	X L X H		
STF2000	44½"	x 27" x 76"H	243	\$565.58



4-Shelf Starter Unit

DESCRIPTION		CHROME	SILVER	DESCRIPTION		CHROME	SILVER
W X L X H	LBS.	CAT. NO.	CAT. NO.	W X L X H	LBS.	CAT. NO.	CAT. NO.
18" x 24" x 63"	49	18246C	18246EP	24" x 30" x 74"	71	24307C	24307EP
18" x 30" x 63"	54	18306C	18306EP	24" x 36" x 74"	81	24367C	24367EP
18" x 36" x 63"	61.5	18366C	18366EP	24" x 42" x 74"	91	24427C	24427EP
18" x 42" x 63"	69	18426C	18426EP	24" x 48" x 74"	96	24487C	24487EP
18" x 48" x 63"	74	18486C	18486EP	24" x 54" x 74"	111	24547C	24547EP
18" x 54" x 63"	86.5	18546C	18546EP	24" x 60" x 74"	121	24607C	24607EP
18" x 60" x 63"	99	18606C	18606EP	24" x 72" x 74"	146	24727C	24727EP
18" x 72" x 63"	114	18726C	18726EP	30" x 36" x 74"	80	30367C	30367EP
24" x 24" x 63"	59	24246C	24246EP	30" x 48" x 74"	96	30487C	30487EP
24" x 30" x 63"	69	24306C	24306EP	30" x 60" x 74"	112	30607C	30607EP
24" x 36" x 63"	79	24366C	24366EP	30" x 72" x 74"	128	30727C	30727EP
24" x 42" x 63"	89	24426C	24426EP	36" x 36" x 74"	86	36367C	36367EP
24" x 48" x 63"	94	24486C	24486EP	36" x 48" x 74"	104	36487C	36487EP
24" x 54" x 63"	109	24546C	24546EP	36" x 60" x 74"	122	36607C	36607EP
24" x 60" x 63"	119	24606C	24606EP	36" x 72" x 74"	140	36727C	36727EP
24" x 72" x 63"	144	24726C	24726EP				
30" x 36" x 63"	78	30366C	30366EP				
30" x 48" x 63"	94	30486C	30486EP				
30" x 60" x 63"	110	30606C	30606EP				
30" x 72" x 63"	126	30726C	30726EP				
36" x 36" x 63"	84	36366C	36366EP				
36" x 48" x 63"	102	36486C	36486EP				
36" x 60" x 63"	120	36606C	36606EP				
36" x 72" x 63"	138	36726C	36726EP				
18" x 24" x 74"	51	18247C	18247EP				
18" x 30" x 74"	56	18307C	18307EP				
18" x 36" x 74"	63.5	18367C	18367EP				
18" x 42" x 74"	71	18427C	18427EP				
18" x 48" x 74"	76	18487C	18487EP				
18" x 54" x 74"	88.5	18547C	18547EP				
18" x 60" x 74"	101	18607C	18607EP				
18" x 72" x 74"	116	18727C	18727EP				
24" x 24" x 74"	61	24247C	24247EP				



SHIPPING INFORMATION:

Northeastern
Robbinsville, NJ, 2 days
Southeastern
Buford, GA, 2 days
Midwest
Pleasant Prairie, WI, 2 days
Western
North Las Vegas, NV, 2 days.



4-Shelf Starter Unit

The 4-Shelf Starter Unit is available in 2 finishes. The chrome is electroplated nickel chrome resulting in a brilliant high gloss finish. It is a quality finish that is both hard and durable with a high tech look at an economical price. This finish is perfect for display and dry storage. Limited 1-year warranty against rust and corrosion. Starter units consist of four shelves and four posts. The Silver EP Series carries a limited seven-year warranty against rust and corrosion. NSF listed for both wet and dry applications.



Polymer Utility Cart, myCart™ Series

- Personalized: Each cart comes with two labels for easy identification.
- Ultimate Cleanability: Smooth polymer shelf surfaces with contoured edges are designed to resist staining and wipe clean easily.
- Contains Spills: 7/16" (11mm) ship's edge retains small spills and prevents items from sliding off during transport.
- Easy-to-Adjust: Optional center shelf adjusts on 1" (25mm) increments.
- Easy, No-Tool Assembly: Ships knocked down.

Polymer Utility Cart, myCart™ Series

CAT. NO. - GRAY	CAT. NO. - BLACK	NO. OF SHELVES	W X H X D	LOAD RATING PER CART (LBS.)
MY1627-24G	MY1627-24BL	2	18 ⁵ / ₁₆ " x 31 ¹ / ₂ " x 35 ¹ / ₂ "	300
MY1627-34G	MY1627-34BL	3	18 ⁵ / ₁₆ " x 31 ¹ / ₂ " x 35 ¹ / ₂ "	400
MY2030-24G	MY2030-24BL	2	23 ¹ / ₁₆ " x 34 ³ / ₈ " x 35 ¹ / ₂ "	300
MY2030-34G	MY2030-34BL	3	23 ¹ / ₁₆ " x 34 ³ / ₈ " x 35 ¹ / ₂ "	400
MY2636-25G	MY2636-25BL	2	27 ¹ / ₁₆ " x 40 ¹ / ₄ " x 36 ³ / ₈ "	400
MY2636-35G	MY2636-35BL	3	27 ¹ / ₁₆ " x 40 ¹ / ₄ " x 36 ³ / ₈ "	500



MY2030-34G
(Shown with optional wastebasket and bin)



MY2636-35BL

ACCESSORIES

WASTE BASKET

CAT. NO.	DESCRIPTION	FITS CART	W X H X D
MYWB1	Wastebasket (including holder)	MY1627	17 ⁷ / ₈ " x 16 ¹ / ₄ " x 14 ³ / ₄ "
MYWB2	Wastebasket (including holder)	MY2030	23" x 16 ¹ / ₄ " x 14 ³ / ₄ "
MF222	Wastebasket only	MY1627, MY230	14 ³ / ₈ " x 15 ³ / ₈ " x 10 ³ / ₈ "

UTILITY BIN

CAT. NO.	DESCRIPTION	FITS CART	W X H X D
MYUB1	Utility Bin (including holder)	MY1627	17 ⁷ / ₈ " x 7" x 15 ¹ / ₄ "
MYUB2	Utility Bin (including holder)	MY2030	23" x 7" x 15 ¹ / ₄ "
UB1	Utility Bin only	MY1627, MY230	16 ³ / ₈ " x 6" x 11"

SHIPPING INFORMATION: 1 Week, F.O.B. Murfreesboro, TN — Ships UPS

A. 4 Wire Shelf Mobile Cart

Mobile wire stem caster carts add versatility and flexibility to any operation, creating a transport system.

- Central supply and distribution
- Stock rotation
- Laundry
- Staging

Each unit consists of:

- 4 - posts
- 4 - wire shelves
- 4 - donut bumpers
- 4 - 5" poly stem casters, 2 with brakes



M1836C46

CAT. NO.	W X L X H	LBS.
63"H Post, 5" Stem Caster Unit		
M1836C46	18" x 36" x 69"	62
M1848C46	18" x 48" x 69"	70
M1860C46	18" x 60" x 69"	90
M2436C46	24" x 36" x 69"	74
M2448C46	24" x 48" x 69"	86
M2460C46	24" x 60" x 69"	106
74"H Post, 5" Stem Caster Unit		
M1836C47	18" x 36" x 80"	64
M1848C47	18" x 48" x 80"	72
M1860C47	18" x 60" x 80"	92
M2436C47	24" x 36" x 80"	76
M2448C47	24" x 48" x 80"	88
M2460C47	24" x 60" x 80"	108



Stem Caster Carts

Made out of durable steel and finished with bright chrome plating, these rugged carts can support 1000 lbs. of product.

The wire style cart provides great visibility and does not collect dirt or dust. It's perfect for any dry environment.

B. 3 Wire/1 Solid Shelf Mobile Cart

Stem caster cart with solid bottom shelf. The unique combination of wire and solid shelves allows for air circulation and high visibility. The solid shelf in the bottom position prevents dust and dirt to rise, and contains spillage.

Each unit consists of:

- 4 - posts
- 3 - wire shelves
- 1 - solid shelf
- 4 - donut bumpers
- 4 - 5" poly stem casters, 2 with brakes



M1836CG46

CAT. NO.	W X L X H	LBS.
63"H Post, 5" Stem Caster Unit		
M1836CG46	18" x 36" x 69"	68
M1848CG46	18" x 48" x 69"	76
M1860CG46	18" x 60" x 69"	97
M2436CG46	24" x 36" x 69"	80
M2448CG46	24" x 48" x 69"	94
M2460CG46	24" x 60" x 69"	116
74"H Post, 5" Stem Caster Unit		
M1836CG47	18" x 36" x 80"	70
M1848CG47	18" x 48" x 80"	78
M1860CG47	18" x 60" x 80"	99
M2436CG47	24" x 36" x 80"	82
M2448CG47	24" x 48" x 80"	96
M2460CG47	24" x 60" x 80"	118

C. 4 Solid Shelf Mobile Cart

Stem caster solid shelf cart is an easy way to transport fluids and small packaged items.

Each unit consists of:

- 4 - posts
- 4 - solid shelves
- 4 - donut bumpers
- 4 - 5" poly stem casters, 2 with brakes



M1836SG46

CAT. NO.	W X L X H	LBS.
63"H Post, 5" Stem Caster Unit		
M1836SG46	18" x 36" x 69"	86
M1848SG46	18" x 48" x 69"	102
M1860SG46	18" x 60" x 69"	118
M2436SG46	24" x 36" x 69"	98
M2448SG46	24" x 48" x 69"	102
M2460SG46	24" x 60" x 69"	146
74"H Post, 5" Stem Caster Unit		
M1836SG47	18" x 36" x 80"	88
M1848SG47	18" x 48" x 80"	104
M1860SG47	18" x 60" x 80"	120
M2436SG47	24" x 36" x 80"	100
M2448SG47	24" x 48" x 80"	104
M2460SG47	24" x 60" x 80"	148

SHIPPING INFORMATION: 1-2 Weeks, F.O.B. Fresno, CA; Miami, FL; Chicago, IL

D. SpeedCart™

BACK-TO-BACK LOADED CARTS

CAT. NO.	W	CELL H	COLUMN H	D	COLUMNS/ CART	CELLS/ CART
CRT-01-1848-A	10.5"	11.1"	55.5"	8.5"	8	40
CRT-02-1860-A	10.5"	11.1"	55.5"	8.5"	10	50
CRT-03-1848-B	13.5"	11.1"	55.5"	8.5"	6	30
CRT-04-1860-B	13.5"	11.1"	55.5"	8.5"	8	40
CRT-05-2448-C	10.5"	11.1"	55.5"	11.5"	8	40
CRT-06-2460-C	10.5"	11.1"	55.5"	11.5"	10	50
CRT-07-2448-D	13.5"	11.1"	55.5"	11.5"	6	30
CRT-08-2460-D	13.5"	11.1"	55.5"	11.5"	8	40

SINGLE-LOADED CARTS

CAT. NO.	W	CELL H	COLUMN H	D	COLUMNS/ CART	CELLS/ CART
CRT-09-1848-E	10.5"	11.1"	55.5"	17.5"	4	20
CRT-10-1860-E	10.5"	11.1"	55.5"	17.5"	5	25
CRT-11-1848-F	13.5"	11.1"	55.5"	17.5"	3	15
CRT-12-1860-F	13.5"	11.1"	55.5"	17.5"	4	20
CRT-13-2448-G	10.5"	11.1"	55.5"	23.5"	4	20
CRT-14-2460-G	10.5"	11.1"	55.5"	23.5"	5	25
CRT-15-2448-H	13.5"	11.1"	55.5"	23.5"	3	15
CRT-16-2460-H	13.5"	11.1"	55.5"	23.5"	4	20



D.

SpeedCart™

Here's a flexible, mobile solution for restocking, order fulfillment, seasonal demands, and more! Constructed from the same lightweight, yet heavy-duty materials as standard SpeedCell storage solutions, the mobile Cart is designed for years of low-maintenance, demanding warehouse environment use. Single-side loading, back-to-back loading or custom configurable allowing greater SKU availability.

SHIPPING INFORMATION: F.O.B. Zeeland, MI



Three-Sided Bulk Trucks

Ideal for transporting or staging of bulkier materials. All models have a 12-gauge reinforced deck and two swivel, two rigid casters with a pushbar handle on swivel caster end. All-welded units have a powder-coated finish and ship fully assembled.

Removable Drop-Gate Truck

Three-sided bulk handling truck converts into a four-sided box truck with the addition of a removable half "drop-gate" panel. Hinged in the center, it can easily be lowered to provide better access while loading or unloading, or raised and latched to secure contents for transport or storage. Expanded metal sides allow better visibility and airflow.

Order Picking Truck

Large capacity, three-shelf truck designed to securely attach to your order picker. Two full-width fork pockets on 24" centers and 1½" steel grab bar make attachment easy. Shelves have 19" clearance.

Three-Sided Bulk Trucks

A. Mesh Sides - 6 x 2 Polyurethane

- 13-gauge flattened expanded metal with 1½" angle iron corners and top trim
- 48" interior height
- Capacity: 3600 lbs.

DECK SIZE		
D X W	CAT. NO.	LBS.
24" x 48"	T1-2448-6PY	139
24" x 60"	T1-2460-6PY	155
30" x 48"	T1-3048-6PY	157
30" x 60"	T1-3060-6PY	174

WARNING: Cancer and reproductive harm - www.P65Warnings.ca.gov



A. T1-2448-6PY

B. Tubular Steel Sides - - 6 x 2 Polyurethane

- 1.05" O.D. x 14-gauge round steel tubing
- 48" interior height
- Capacity: 3600 lbs.

DECK SIZE		
D X W	CAT. NO.	LBS.
24" x 36"	OT2436-6PY	108
24" x 48"	OT2448-6PY	126
24" x 60"	OT2460-6PY	143
30" x 48"	OT3048-6PY	139
30" x 60"	OT3060-6PY	157

WARNING: Cancer and reproductive harm - www.P65Warnings.ca.gov



B. OT-2448-6PPY

C. Order Picking Truck

- 3600 lbs. capacity
- Overall height is 68"
- 2 rigid and 2 swivel 6" polyurethane casters assure smooth rolling, even with a full load of 3600 lbs.
- 48" length allows the unit to fit down any aisle

SIZE	CAT. NO.	LBS.
24" x 48"	T3-2448-6PYFP60	258
30" x 48"	T3-3048-6PYFP60	295

WARNING: Cancer and reproductive harm - www.P65Warnings.ca.gov



C. T3-2448-6PYFP60

SHIPPING INFORMATION: 2 Weeks, F.O.B. University Park, IL



Model 5M-2448-6PH

Multi-Shelf Trucks — Storage Rack on Wheels

	LIP SHELVES		FLUSH SHELVES		SHELF CLEARANCE	LBS.
	CAT. NO.		CAT. NO.	W X L X H		
THREE SHELF	3ML-2436-6PH		3M-2436-6PH	24" x 36" x 45"	16½"	142
	3ML-2448-6PH		3M-2448-6PH	24" x 48" x 45"	16½"	173
	3ML-3048-6PH		3M-3048-6PH	30" x 48" x 45"	16½"	204
FOUR SHELF	3ML-3060-6PH		3M-3060-6PH	30" x 60" x 45"	16½"	244
	4ML-2436-6PH		4M-2436-6PH	24" x 36" x 63"	16½"	175
	4ML-2448-6PH		4M-2448-6PH	24" x 48" x 63"	16½"	216
FIVE SHELF	4ML-3048-6PH		4M-3048-6PH	30" x 48" x 63"	16½"	256
	4ML-3060-6PH		4M-3060-6PH	30" x 60" x 63"	16½"	309
	5ML-2436-6PH		5M-2436-6PH	24" x 36" x 63"	12"	207
	5ML-2448-6PH		5M-2448-6PH	24" x 48" x 63"	12"	258
	5ML-3048-6PH		5M-3048-6PH	30" x 48" x 63"	12"	307
			5ML-3060-6PH	30" x 60" x 63"	12"	373

WARNING: Cancer and reproductive harm - www.P65Warnings.ca.gov

Extra-Heavy-Duty Shelf Trucks



Model GH-3048-8PHK

SHELF SIZE	2 RIGID, 2 SWIVEL CASTERS			
	2 SHELVES		3 SHELVES	
CAT. NO.	LBS.	CAT. NO.	LBS.	
24" x 36"	GH-2436-8PHK	144	3GH-2436-8PHK	177
24" x 48"	GH-2448-8PHK	167	3GH-2448-8PHK	209
30" x 48"	GH-3048-8PHK	190	3GH-3048-8PHK	242
30" x 60"	GH-3060-8PHK	216	3GH-3060-8PHK	280
36" x 72"	GH-3672-8PHK	275	3GH-3672-8PHK	365



Model 3GH348-8PHKPL

SHELF SIZE	4 SWIVEL CASTERS			
	2 with wheel brakes, 2 with swivel locks that convert from swivel to rigid casters			
	2 SHELVES		3 SHELVES	
CAT. NO.	LBS.	CAT. NO.	LBS.	
24" x 36"	GH-2436-8PHKBKPL	147	3GH236-8PHKBKPL	180
24" x 48"	GH-2448-8PHKBKPL	170	3GH248-8PHKBKPL	212
30" x 48"	GH-3048-8PHKBKPL	193	3GH348-8PHKBKPL	245
30" x 60"	GH-3060-8PHKBKPL	219	3GH360-8PHKBKPL	283
36" x 72"	GH-3672-8PHKBKPL	278	3GH372-8PHKBKPL	368

Floor Lock Option: add: -FL (only available on 2 rigid and 2 swivel caster option)

WARNING: Cancer and reproductive harm - www.P65Warnings.ca.gov

Merchandise Collectors



Model G-2448-8PYBK

CAPACITY & WHEELS	SHELF SIZE W X L	LIP EDGE SHELVES		LBS.
		CAT. NO.	CAT. NO.	
8" x 2" Polyurethane w/Brakes 3600 lbs. Top Shelf 32" H	24" x 36"	GL-2436-8PYBK	G-2436-8PYBK	111
	24" x 48"	GL-2448-8PYBK	G-2448-8PYBK	136
	30" x 48"	GL-3048-8PYBK	G-3048-8PYBK	154
	30" x 60"	GL-3060-8PYBK	G-3060-8PYBK	180
8" x 2" Mold-on Rubber Tired 2400 lbs. Top Shelf 32" H	24" x 36"	GL-2436-8MR	G-2436-8MR	128
	24" x 48"	GL-2448-8MR	G-2448-8MR	153
	30" x 48"	GL-3048-8MR	G-3048-8MR	171
6" x 2" Polyurethane 3600 lbs. Top Shelf 30" H	24" x 36"	GL-2436-6PY	G-2436-6PY	113
	24" x 48"	GL-2448-6PY	G-2448-6PY	138
	30" x 48"	GL-3048-6PY	G-3048-6PY	156
	30" x 60"	GL-3060-6PY	G-3060-6PY	182

WARNING: Cancer and reproductive harm - www.P65Warnings.ca.gov

Heavy-Duty Shelf Trucks



Model 2G-2448-6PHBK

	LIP SHELVES		FLUSH SHELVES		LBS.
	CAT. NO.		CAT. NO.	W X L X H	
TWO SHELF	24" CLEARANCE		25½" CLEARANCE		
	2GL-2436-6PHBK		2G-2436-6PHBK	24" x 36" x 36"	112
	2GL-2448-6PHBK		2G-2448-6PHBK	24" x 48" x 36"	138
	2GL-3048-6PHBK		2G-3048-6PHBK	30" x 48" x 36"	154
			2GL-3060-6PHBK	30" x 60" x 36"	182



Model 3G-2436-6PHBK

	11" CLEARANCE		12" CLEARANCE		LBS.
	CAT. NO.		CAT. NO.	W X L X H	
THREE SHELF	3GL-2436-6PHBK		3G-2436-6PHBK	24" x 36" x 36"	156
	3GL-2448-6PHBK		3G-2448-6PHBK	24" x 48" x 36"	185
	3GL-3048-6PHBK		3G-3048-6PHBK	30" x 48" x 36"	201
	3GL-3060-6PHBK		3G-3060-6PHBK	30" x 60" x 36"	251

For 6" Polyurethane with Brakes, add wheel code: -6PYBK (3600 lb. capacity)

Floor Lock Option: add: -FL

WARNING: Cancer and reproductive harm - www.P65Warnings.ca.gov

SHIPPING INFORMATION: 2 Weeks, F.O.B. University Park, IL



Multi-Shelf Trucks

Heavy-duty trucks with three, four or five shelves. All-welded 12-gauge steel shelves provide plenty of space to transport large loads. Also used as portable storage racks that can be moved for cleaning or to different locations. Two rigid and two swivel casters with 6" x 2" phenolic wheels welded to sub-frame. Comfortable formed 1" tubular steel push handle. Shelves available flush or with 1½" retaining lip. 3600 lb. capacity.

Extra-Heavy-Duty Shelf Trucks

All-welded construction features flush 12 gauge steel shelves with extra reinforcement and 2" x 2" corner angles for increased capacity. Top shelf is 36" high. Clearance between shelves is 23" for 2-shelf models, and 10½" for 3-shelf models. More maneuverable with heavy-duty 8" phenolic kingpinless casters. Durable powder coated finish.

Merchandise Collectors

2400 lb. to 3600 lb. capacity. Shelves are formed from 12-gauge steel with structural angle sub-frame and shelf reinforcements. Shelves are available with 1½" lip, or with flush edges. Raised offset handle includes cross brace hand guard for added safety. These welded units are shipped set up and ready for immediate use, with 2 swivel and 2 rigid casters. Shelf clearance 18" with lipped shelves, 19½" with flush shelves.

Heavy-Duty Shelf Trucks

3600 lbs. capacity. 12-gauge shelves handle the heaviest of loads. Available in 2 or 3 shelf models. Shelves available with flush edges, or with 1½" retaining lip. 2 swivel and 2 rigid casters with 6" x 2" hard tread phenolic wheels for added maneuverability under heavy loads. Swivel casters have wheel brakes to stop unwanted movement when loading and unloading. 36" overall height.



Welded Service Cart

Little Giant durability in an economical shelf truck for medium-duty applications. These all-welded units ship fully assembled. Features include heavy 12-gauge shelves and non-marking 5" polyurethane casters with ball-bearing wheels. Bottom shelf has retaining lip for small parts. Top shelf is 35" above ground, and is available with lip up or down (flush top).

6-Inch Deep Shelf Truck

Features 6" high shelf lips and heavy 12-gauge welded construction. Polyurethane casters roll quietly and easily under heavier load conditions. Clearance between shelves is 16½".

Low Deck Truck

Top deck is 24" high to minimize bending & lifting. Bottom shelf has 1½" retaining lip; top shelf is available with a lip or flush. Clearance between shelves is 14". Rolls easily on 5" non-marking polyurethane casters, two swivel with wheel brakes and two rigid.

Three-Sided Mesh Shelf Truck

Heavy 12-gauge shelves are enclosed on three sides, 48" high above the deck in sturdy 1½" angle iron corners and top trim. Mesh sides allow visibility and air circulation. Two swivel, two rigid 6" x 2" polyurethane casters.

Pick-Pack Truck

Upper shelves are sloped to keep contents from falling off. Bottom shelf has a 1½" retaining lip. Expanded metal divider and ends permit visibility while securing contents. Quick turn diamond caster pattern for narrow aisle maneuvering—steers from either end.

A. Welded Service Cart

- 1200 lb. capacity
- Two shelves; 25" shelf clearance
- Overall height: 35"

LIP SHELVES		FLUSH TOP		SHELF SIZE	
CAT. NO.	CAT. NO.	W X L	W X L	LBS.	LBS.
LGL-1824-BRK	LG-1824-BRK	18" x 24"	18" x 24"	55	55
LGL-1832-BRK	LG-1832-BRK	18" x 32"	18" x 32"	65	65
LGL-2436-BRK	LG-2436-BRK	24" x 36"	24" x 36"	84	84
LGL-2448-BRK	LG-2448-BRK	24" x 48"	24" x 48"	103	103
LGL-3048-BRK	LG-3048-BRK	30" x 48"	30" x 48"	125	125
LGL-3060-BRK	LG-3060-BRK	30" x 60"	30" x 60"	152	152

Standard with two swivel casters with brakes and two rigid casters; also available with four swivel casters with brakes — call for pricing

⚠️ **WARNING:** Cancer and reproductive harm - www.P65Warnings.ca.gov

A.



Model LGL-2436-BRK

B. 6-Inch Deep Shelf Truck

- 1200 lb. and 3600 lb. capacity models

CAT. NO.	SHELF SIZE W X L	CAPACITY (LBS.)	OVERALL HEIGHT	CASTERS	LBS.
DS1830X6-5PY	18" x 30"	1200	35"	5"	87
DS2436X6-5PY	24" x 36"	1200	35"	5"	116
DS1830X6-6PY	18" x 30"	3600	36.5"	6"	97
DS2436X6-6PY	24" x 36"	3600	36.5"	6"	126
DS2448X6-6PY	24" x 48"	3600	36.5"	6"	1577

⚠️ **WARNING:** Cancer and reproductive harm - www.P65Warnings.ca.gov

B.



Model DS2436X6-6PY

C. Low Deck Truck — With Sloped Handle

- 1200 lb. capacity

LIP SHELVES		FLUSH TOP		SHELF SIZE	
CAT. NO.	CAT. NO.	W X L	W X L	LBS.	LBS.
LKL-1824-5PYBK	LK-1824-5PYBK	18" x 24"	18" x 24"	53	53
LKL-1832-5PYBK	LK-1832-5PYBK	18" x 32"	18" x 32"	62	62
LKL-2436-5PYBK	LK-2436-5PYBK	24" x 36"	24" x 36"	82	82
LKL-2448-5PYBK	LK-2448-5PYBK	24" x 48"	24" x 48"	101	101
LKL-3048-5PYBK	LK-3048-5PYBK	30" x 48"	30" x 48"	132	132
LKL-3060-5PYBK	LK-3060-5PYBK	30" x 60"	30" x 60"	161	161

⚠️ **WARNING:** Cancer and reproductive harm - www.P65Warnings.ca.gov

C.

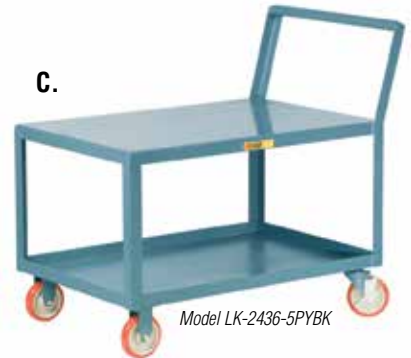

Model LK-2436-5PYBK

D. Three-Sided Mesh Shelf Truck

- 3600 lb. capacity
- Two-shelf models have 22½" clearance
- Three-shelf models have 15" clearance
- Overall height: 57"
- Mesh sides: 13 gauge flattened expanded metal

SHELF SIZE W X L	TWO SHELVES		THREE SHELVES	
	CAT. NO.	LBS.	CAT. NO.	LBS.
24" x 48"	T2-2448-6PY	173	T3-2448-6PY	219
24" x 60"	T2-2460-6PY	198	T3-2460-6PY	250
30" x 48"	T2-3048-6PY	200	T3-3048-6PY	251
30" x 60"	T2-3060-6PY	229	T3-3060-6PY	293

⚠️ **WARNING:** Cancer and reproductive harm - www.P65Warnings.ca.gov

D.



Model T3-3060-6PY

E. Pick-Pack Truck

- 1600 lb. capacity
- Has sloped shelves and divider
- Clearance between shelves: 14"
- 6" x 2" mold-on rubber casters

CAT. NO.	OVERALL SIZE W X L	SHELF SIZE W X L	LBS.
PPT-2848-6M	28" x 48"	14" x 48"	225
PPT-2860-6M	28" x 60"	14" x 60"	255

⚠️ **WARNING:** Cancer and reproductive harm - www.P65Warnings.ca.gov

E.



Model PPT-2860-6M

SHIPPING INFORMATION: 2 Weeks, F.O.B. University Park, IL



Wire Reel Caddy

- All-welded Wire Reel Caddy has four 16" wide rods for holding multiple wire reel configurations
- Top three rods are 7" on-center
- Wheels are off the ground while standing so it does not "walk" while pulling wire

Wire Reel Cart with Cabinet

- All-welded Electrician's Cart carries everything you need for a wiring project
- Supplied with five 15" long spool holder rods to allow numerous wire reel configurations
- Heavy 12-gauge steel shelves have a 1½" lip to retain small parts
- Hanger bar on side of cart for convenient ladder storage
- Casters are 5" polyurethane - 2 swivel and 2 rigid; swivel casters feature total-lock wheel brake that locks both the swivel and the wheel

Order Picking Truck

- Convenient 21" x 12" writing shelf for paperwork
- Bottom shelf has 1½" retaining lip; top shelf is available with a lip or flush
- Two swivel and two rigid casters feature non-marking 5" polyurethane wheels with ball bearings

A. Wire Reel Caddy

- Full width handle
- Convenient tool tray for storage and transport of hand tools
- Heavy-duty angle iron frame
- Wheels are 8" x 2½" solid rubber with ball bearings
- Durable powder-coated gray finish
- Ships via UPS

CAT. NO.	LBS.
RT4-8S	54

WARNING: Cancer and reproductive harm - www.P65Warnings.ca.gov

SHIPPING INFORMATION:
2 Weeks, F.O.B. University Park, IL



A.

B. Wire Reel Cart with Cabinet

- Top shelf is 24" wide x 36" long x 35" high
- Storage cabinet with locking door and keyed handle measures 16" W x 23" D x 25" H
- Bottom shelf measures 24" wide with a 12" extension for upright storage and transport of conduit or other long material
- Overall length is 54"
- Durable powder-coated gray finish
- Ships assembled

CAT. NO.	LBS.
RCM2448-5PYTL	152

WARNING: Cancer and reproductive harm - www.P65Warnings.ca.gov

SHIPPING INFORMATION:
2 Weeks, F.O.B. University Park, IL



B.



C. Order Picking Truck

- 1200 lb. capacity
- Top shelf height: 35"; writing shelf height: 39"
- Swivel casters have wheel brakes

LIP SHELVES		FLUSH TOP	
CAT. NO.	CAT. NO.	W X L	LBS.
LGL-2436-WSBRK	LG-2436-WSBRK	24" x 36"	101
LGL-2448-WSBRK	LG-2448-WSBRK	24" x 48"	120

WARNING: Cancer and reproductive harm - www.P65Warnings.ca.gov

Optional storage pocket available; call for pricing.



SHIPPING INFORMATION: 2 Weeks F.O.B. University Park, IL



C.

A. Canvas and Vinyl Trucks

Available in natural canvas, Steeletex vinyl coated nylon grey (standard); other colors available upon request.

CAT. NO. ◆	BUSHEL SIZE	INSIDE DIM. L X W X D
926CNATVGRYW3	6	30" x 20" x 20½"
928CNATVGRYW3	8	34" x 22" x 23"
9210CNATVGRYW3	10	36" x 24" x 25"
9212CNATVGRYW3	12	36" x 26" x 27½"
9214CNATVGRYW3	14	40" x 28" x 27½"
9216CNATVGRYW3	16	40" x 28" x 30"
9218CNATVGRYW3	18	42" x 30" x 30"
9220CNATVGRYW3	20	44" x 32" x 33"

* Add -S to model number for Steeletex Vinyl-Coated Nylon Gray

** Add -S (color) for optional colors

◆ Change CAT. NO. from 92 to 94 for diamond-mounted casters.

B. Hospital Type Trucks

Available in white canvas, Steeletex vinyl coated nylon grey (standard); other colors available upon request.

CAT. NO. ◆	BUSHEL SIZE	INSIDE DIM. L X W X D
92R6CNATW3	6	30" x 20" x 20½"
92R8CNATW3	8	34" x 22" x 23"
92R10CNATW3	10	36" x 24" x 25"
92R12CNATW3	12	36" x 26" x 27½"
92R14CNATW3	14	40" x 28" x 27½"
92R16CNATW3	16	40" x 28" x 30"
92R18CNATW3	18	42" x 30" x 30"
92R20CNATW3	20	44" x 32" x 33"

* Add -S to model number for Steeletex Vinyl Coated Nylon.

◆ Change CAT. NO. from 94R to 92R for corner-mounted casters.

A. Model No. 92, 92-S with corner-mounted casters



◆ Model No. 94R, 94R-S same as Model 92 and 92-S except for diamond mounted casters.



B. Model No. 94R and 94R-S DIAMOND-MOUNTED CASTERS (No. 92S and 92R-S corner mounted casters also available.)

Available in Natural Canvas and Steeletex Vinyl-Coated Nylon

C. Regular Duty Polyethylene Trucks*

.190 thick. Standard color is white; other colors available

CAT. NO.	BUSHEL SIZE	STANDARD CASTERS	INSIDE DIM. L X W X D
926PCWHTW3	6	3½	29" x 19" x 21½"
928PCWHTW3	8	3½	33" x 21" x 24"
9210PCWHTW3	10	3½	35" x 23" x 26"
9212PCWHTW3	12	3½	36" x 24" x 28½"
9214PCWHTW3	14	3½	39" x 27" x 28½"
9216PCWHTW3	16	3½	39" x 27" x 31"
9218PCWHTW5	18	5	41" x 29" x 31"
92PC22WHTW5	20	5	47" x 31" x 31"

Please specify color when ordering *F.O.B. 4 Weeks, Latta, SC

C. Model No. 92PC-Corner Mounted Casters

Standard color is white; other colors available



D. Heavy Duty Polyethylene Trucks

.250 thick. Standard color is white; other colors available

CAT. NO. ◆	GALLON CAPACITY	BUSHEL SIZE	INSIDE DIM. L X W X D
926PDWHTW3	44	6	30" x 20" x 20½"
928PDWHTW3	61	8	34" x 22" x 23"
9210PDWHTW3	77	10	36" x 24" x 25"
9212PDWHTW3	92	12	36" x 26" x 27½"
9214PDWHTW4	95	14	40" x 28" x 27½"
9216PDWHTW4	104	16	40" x 28" x 30"
9218PDWHTW4	117	18	42" x 30" x 30"
9220PDWHTW4	143	20	44" x 32" x 33"

◆ Change CAT. NO. from 92PD to 94PD for corner-mounted casters.



◆ Model No. 94PD - same as Model No 92PD except with DIAMOND-MOUNTED CASTERS

D. Model No. 92PD - Corner Mounted Casters



STEELE
CANVAS BASKET CORP

Canvas and Vinyl Trucks

Model 92 has four corner-mounted swivel casters. Models 94 and 94R have two swivel and two rigid diamond-mounted casters. Standard color for vinyl trucks is grey. Trucks are available in other colors – call for information.



Self-elevating spring lift platforms available – call for information.

STEELENE™ Polyethylene Trucks

Available in regular duty (.190 thick, Model 92PC) or heavy duty (.250 thick, Model 92PD). Models 92PC and 92PD have four corner-mounted swivel casters. Model 94PD has two swivel and two rigid diamond-mounted casters. Standard color for polyethylene trucks is white.

Replacement liners available in canvas, vinyl & polyethylene (framed trucks only).

Custom units available to fit your facilities' needs – call for information.

Steel surcharges that we were aware of prior to the printing of this catalog have been included in the price. Due to the volatility of this situation, additional surcharges may need to be added to orders once they have been placed. Unfortunately, these charges will be included in our final billing.



A. Channel Pallets

- All-welded construction.
 - Fireproof
 - Recyclable
 - Metal Detectable
 - UV Resistant
- Heavy 6005 T-6 Type Aluminum.
- Stackable/Nestable.
- Open channels for easy cleaning.
- Lifetime Guarantee against rust and corrosion.

LOAD WEIGHTS:

STATIC	30,000 LBS.
DYNAMIC	5,000 LBS.
RACKABLE	5,000 LBS.
TRUCKLOAD	510 T.L.
ALUMINUM WEIGHT	50 LBS.

CAT NO.	SIZE W-H-D	ENTRY TYPE	NET LBS.	SHIP LBS.
99557	40" x 5" x 48"	2-WAY	50	64
99387	40" x 5" x 48"	4-WAY	50	51

CUSTOM SIZES AVAILABLE



B. Tube Frame Pallets

- All-welded construction.
 - Fireproof
 - Recyclable
 - Metal Detectable
 - UV Resistant
- Sealed tube, all welded frame construction
- Four-way pallets.
- Lifetime Guarantee against rust and corrosion.

CAT NO.	SIZE W-H-D	NET LBS.	SHIP LBS.
52400	40" x 5 1/4" x 40"	41	47
99613*	40" x 5 1/4" x 48"	48	51
99749	40" x 5 1/4" x 48"	45	53
50788	48" x 5 1/4" x 48"	51	53

* Equipped with center base tube as shown.

LOAD WEIGHTS:

	99613/99749	50788
STATIC	30,000 LBS.	20,000 LBS.
DYNAMIC	5,000 LBS.	4,000 LBS.
RACKABLE	5,000 LBS.	4,000 LBS.
TRUCKLOAD	510 T.L.	442 T.L.
ALUMINUM WEIGHT	49 LBS.	51 LBS.

C. Forklift Picking Platform

- Order Picker secures to order picker cage via 2" x 4" wood block.
- Fork pockets are 4" x 6" x 1/4" wall tube.
- Replaceable wood clamp block.
- Anti-slip tape on end.
- Heavy duty aluminum construction.
- Lightweight and durable.
- Lifetime Guarantee against rust and corrosion.

CAT NO.	SIZE W-H-D	DECK HEIGHT	SHIP LBS.
PPC4048	40" x 10 7/8" x 48"	5 5/16"	144

"DH" is the measurement from the top of the fork to the top of the deck.

Custom Sizes Available.



PPC4048

A. Ergo Stands

These lightweight, aluminum stands help level the height difference between employees, providing a safe and comfortable work height for everyone.

- 1" and 2" Ergo Stands are ideal for wet, slippery environments.
- Anti-Slip, raised tread, perforated top, has 3" O.C. spacing. Disrupted elevation = 3/16".
- All aluminum construction - Guaranteed rust free!

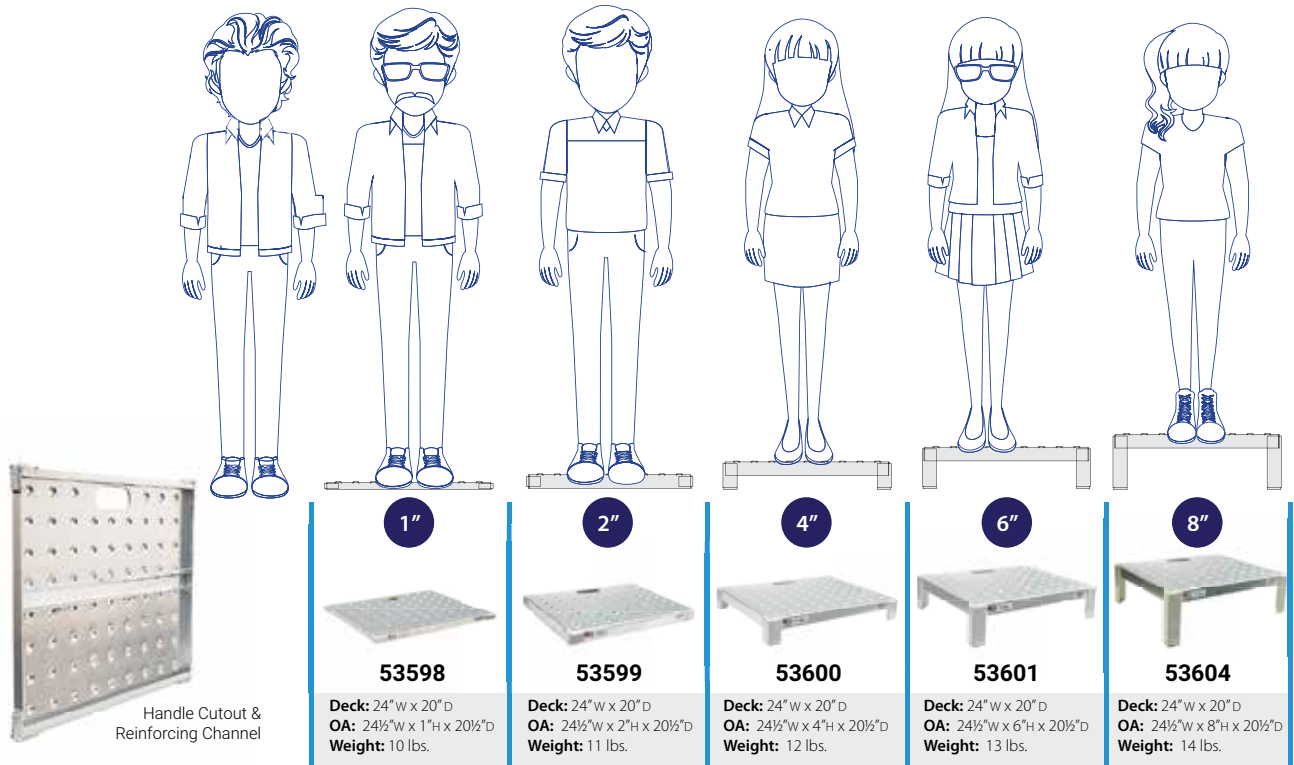

Model	Stand Height	Deck: 24" W x 20" D	OA: 24 1/2" W x 2" H x 20 1/2" D	Weight
53598	1"	24" W x 20" D	24 1/2" W x 2" H x 20 1/2" D	10 lbs.
53599	2"	24" W x 20" D	24 1/2" W x 4" H x 20 1/2" D	11 lbs.
53600	4"	24" W x 20" D	24 1/2" W x 6" H x 20 1/2" D	12 lbs.
53601	6"	24" W x 20" D	24 1/2" W x 8" H x 20 1/2" D	13 lbs.
53604	8"	24" W x 20" D	24 1/2" W x 10" H x 20 1/2" D	14 lbs.



B. Three-Step Ladder Cart

1. Spring loaded, full contact ladder stops.
2. Extended push handle.

CAT NO.	SIZE (W X H X L)	NUMBER OF SHELVES	TOP SHELF HEIGHT	SHELF SPACING	SHIP (LBS.)
FLAT TOP SHELVES					
999640	22" x 69 1/2" x 51 1/2"	2	38"	21 3/4"	113
99555	22" x 69 1/2" x 51 1/2"	3	38"	13 1/2"	120
LIP EDGE SHELVES - UP ON ALL FOUR SIDES					
50060	22" x 69 1/2" x 51 1/2"	2	38"	27 3/8"	113
99555	22" x 69 1/2" x 51 1/2"	3	38"	12 9/16"	120

Four 5" plate type casters; two swivel, two rigid.
Weight Capacity = 800lbs.

C. Folding Ladder Cart

Features two solid sheet shelves and a T-Bar base.

- Equipped with four, plate type casters; two swivel for maneuvering and two rigid that allow the cart to drive straight.



CAT NO.	SIZE (W X H X D)	SHIP (LBS.)
52008	24" x 52 1/8" x 45 13/16"	95

Weight Capacities: Cart = 800 lbs.
Ladder = 300 lbs.

A. Custom Picking Carts
DESIGNED by YOU, BUILT by YOU.



50311X5
BASE WITH 5-WHEEL OPTION



50313
HANDLE/DESK W/ TRAY
(fits 24" D shelf only)



50314
1 1/2" TUBE HANDLE
(fits 24" D shelf only)



50316
DOCUMENT TRAY
(4"D x 4"H x 16"L)



50318
TRASH CAN W/
HANGER

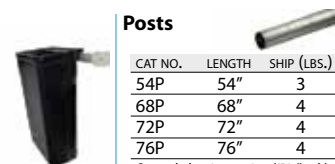

Posts

CAT NO.	LENGTH	SHIP (LBS.)
54P	54"	3
68P	68"	4
72P	72"	4
76P	76"	4

Capped aluminum pipe (1 1/8" o.d.)
Marked in 2" increments.

50311
STANDARD BASE



50311X6
BASE WITH
6-WHEEL OPTION



	Base (9 1/8" H)		HD Shelf		T-Bar Shelf		Solid Brute Shelf	
	WEIGHT CAPACITY = 800 LBS.		WEIGHT CAPACITY = 2000 LBS.		WEIGHT CAPACITY = 1500 LBS.		WEIGHT CAPACITY = 800 LBS.	
	CAT NO.	SHIP (LBS.)	CAT NO.	SHIP (LBS.)	CAT NO.	SHIP (LBS.)	CAT NO.	SHIP (LBS.)
24" x 36"	50310	31	2436HD	10	2436TB	11	2436SB	12
24" x 48"	50311	35	2448HD	12	2448TB	14	2448SB	14
24" x 60"	50012	40	2460HD	15	2460TB	17	2460SB	17

Options: **Five-Wheel, Zero-Turning** - Add "X5" suffix to model number.
Four 5" plate type casters; two swivel, two rigid : One 5" spring-loaded caster
Six-Wheel, Zero-Turning - Add "X6" suffix to model number.
Six 5" plate type casters; four swivel, two rigid

HAND TRUCKS & CARTS

B. Folding U-Boat with Integrated Deck

Capable of holding five hand truck loads worth of product! Holds up to twelve picking totes, but easily folds down and latches to store on end - Requiring less storage space than a stack of totes.

- Open deck area of 62" accommodates four, 15" x 20" stack-and-nest totes across the base.
- Solid integrated deck is easy to clean and allows totes to slide easily when loading and unloading.
- Six-Wheel design allows zero-turn radius.
- All aluminum construction. Lifetime Guarantee against rust and corrosion.



- 20" W x 62" L Working Deck Space.
- Folding handles for upright space-saving storage.
- Weight Capacity = 1,500 lbs.

Optional Removable Solid Shelves - Sold Separately

Dual handles allow the cart to be controlled from either end and provide the framework for the drop-on shelves.

CAT NO.	SIZE (W X H X D)	SHIP (LBS.)
53313A	20" x 64 1/8" x 66 3/4"	80
Removable Solid Shelf - Sold Separately		
53313RS	18 3/8" x 1 1/4" x 62 3/8"	30



A. Multi-Tier Stock Cart

Three-tiered slanted shelf pick cart for totes or tubs.

CAT NO.	SIZE (W X H X D)	SHELF SIZE	CAPACITY (LBS.)	SHIP (LBS.)
97476	59" x 67½" x 26"	24½" x 56"	800	88

Equipped with four, 5" plate type casters; two swivel, two rigid.



B. Picking Cart

These Picking Carts feature three shelves, a document stand, and an ergonomic handle. Heavy duty, T-Bar shelving is strong and durable without being bulky; The T's provide a smooth, flat surface that allows boxes and totes to slide for easy loading and unloading.

- Lifetime Guarantee against rust and corrosion.
- Can be custom built to fit your individual picking needs!

CAT NO.	SIZE (W X H X D)	SHELF SPACING	CAPACITY (LBS.)	SHIP (LBS.)
97986PC	70" x 70" x 21¾"	top = 24" bottom = 20"	800	126
98012	48" x 42½" x 22"	15"	500	100

97986PC: Equipped with four, 5" plate type casters; two swivel, two rigid.

98012PC: Equipped with four, 5" plate type swivel casters.



C. Slanted Picking Cart

Five-wheel configuration with spring-loaded, stabilizing, shock-absorbing caster reduces vibrations over rough surfaces.

- Equipped with writing ledge, tool box, RFID reader storage and clipboard shelf.
- T-Bar Shelves - two slanted and one flat base shelf.
- Dual grip handles.
- Designed for narrow aisle picking.
- Equipped with four 5" x 2" swivel casters and one rigid spring-loaded, stabilizing caster.
- Can be custom built to fit your individual picking needs.

CAT NO.	SIZE (D X H X L)	PRODUCT (LBS.)	SHIP (LBS.)
50548	18" x 60" x 49¾"	90	157

Equipped with five 5" plate type casters; four swivel, one rigid spring-loaded.



Ergonomic Handle



Spring-Loaded Caster



Hardwood Platform Truck

Deck constructed of 1" domestic hardwood stock. One piece, removable push handle. Two swivel and two rigid, industrial-grade casters. Industrial-strength wheels have cast steel centers, molded rubber treads, hardened roller bearings and zerkl fittings for lubrication.

A. Hardwood Platform Trucks

CAT. NO.	DECK SIZE	LBS.
6 x 2 WHEELS - CAPACITY 1600 LBS. - DECK HT. 9 1/4"		
31-005-011	24" x 36"	85
31-005-012	24" x 48"	95
31-005-014	27" x 54"	105
31-005-015	30" x 60"	120
31-005-020	36" x 72"	150
8 x 2 WHEELS - CAPACITY 2000 LBS. - DECK HT. 11 1/4"		
31-005-095	24" x 48"	115
31-005-097	27" x 54"	130
31-005-098	30" x 60"	150
31-005-099	36" x 72"	180

A.



SHIPPING INFORMATION: 1-2 Weeks, F.O.B. Watertown, SD



Commercial Platform Truck

- Turns 360° to maneuver around tight spaces
- Aluminum structure will never rust
- Removable handle can be used at either end of unit

B. Commercial Platform Truck

CAT. NO.	DECK SIZE	CAPACITY (LBS.)	LBS.
BDLK1112	16" x 60"	1200	53
306167	Replacement Handle	—	8

SHIPPING INFORMATION: 1 Week, F.O.B. Standish, MI



Heavy-Duty Platform Trucks

- Sturdy all-welded unit is constructed of a formed 12-gauge steel deck with extra reinforcement on underside
- Removable pipe handle is 1 1/2" OD and has two crossbraces
- Two swivel and two rigid casters with choice of wheels
- Durable powder-coated finish
- Ships fully assembled

Caster Steer Trailers

Versatile unit can be used as an independent platform truck for manual order picking and then quickly connected into a train of trailers. The caster steer design means wheels stay under the load at all times, providing better stability with unevenly distributed loads. The two swivel casters rotate 360°, providing excellent maneuverability even in tight areas.

C. Heavy-Duty Platform Truck

- Capacities: 2000 lbs. for 6" x 2" mold-on rubber
- 2400 lbs. for 8" x 2" mold-on rubber
- 3600 lbs. for 8" x 2" polyurethane non-marking tread with wheel brakes*

Floor Lock Option - Prevents unwanted movement when loading or unloading



C.

DECK SIZE D X W	6 x 2 MOLD-ON RUBBER		8 x 2 MOLD-ON RUBBER WITH FLOOR LOCK		8 x 2 POLYURETHANE NON-MARKING TREAD WITH WHEEL BRAKES*	
	CAT. NO.	LBS.	CAT. NO.	LBS.	CAT. NO.	LBS.
24" x 36"	NBB-2436-6MR	84	NBB-2436-8MRFL	88	NBB-2436-8PYBK	79
24" x 48"	NBB-2448-6MR	95	NBB-2448-8MRFL	99	NBB-2448-8PYBK	90
24" x 60"	NBB-2460-6MR	115	NBB-2460-8MRFL	119	NBB-2460-8PYBK	110
30" x 48"	NBB-3048-6MR	115	NBB-3048-8MRFL	119	NBB-3048-8PYBK	110
30" x 60"	NBB-3060-6MR	127	NBB-3060-8MRFL	131	NBB-3060-8PYBK	125
30" x 72"	NBB-3072-6MR	140	NBB-3072-8MRFL	144	NBB-3072-8PYBK	135
36" x 60"	NBB-3660-6MR	141	NBB-3660-8MRFL	145	NBB-3660-8PYBK	136
36" x 72"	NBB-3672-6MR	157	NBB-3672-8MRFL	161	NBB-3672-8PYBK	152

*Note: Wheel brakes are not intended to stop moving equipment, or for use on ramps or inclines.

⚠️ WARNING: Cancer and reproductive harm - www.P65Warnings.ca.gov

D. Caster Steel Trailer

- Reinforced 12-gauge steel deck is 11 1/2" high
- Heavy service casters to withstand the rigors of towing
- 8" x 2" mold-on rubber wheels with cast iron centers and roller bearings
- Removable pipe rack/pushbar handle extends 29" above the deck
- Ring drawbar stays in upright position for manual operation as a platform truck
- Pin and clevis coupler at rear

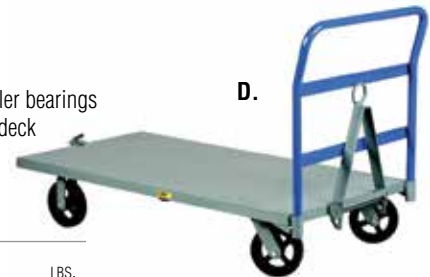

D.

CAT. NO.	DECK SIZE	CAPACITY (LBS.)	LBS.
CS-3060-8MRHD	30" x 60"	2000	160
CS-3072-8MRHD	30" x 72"	2000	175
CS-3660-8MRHD	36" x 60"	2000	178
CS-3672-8MRHD	36" x 72"	2000	195

SHIPPING INFORMATION:
1-2 Weeks,
F.O.B. University Park, IL

⚠️ WARNING: Cancer and reproductive harm - www.P65Warnings.ca.gov



NATIONAL CART CO

Material Handling Carts

ORDER PICKER CART



- Fully welded heavy duty base
- Light weight aluminum deck
- Steel tubular undercarriage accepts forklifts and secured with steel stringer
- Reinforced steel tow socket, acts as a strike zone to prevent damage to aluminum deck when connected with other carts
- Sturdy wire grid is lightweight when securing products within cart and provides high visibility
- Weight: 294 lbs
- Order # 8000803
45" L x 47" W x 58" H
- Optional, shelving kit (order# 7000290)

ECONOMICAL STEEL TOTE PICK CART



- Heavy duty steel construction
- (6) tote capacity
- Ergonomic handle offers ease of handling
- Weight: 114 lbs
- Order # 8000518
48" L x 27" W x 47" H

U-BOAT



- Heavy duty steel construction
- Simple u-boat designed for economical packing
- (6) Wheel tilt design
- Weight: 114 lbs
- Order # 5000101
60" L x 16" W x 62" H

ECONOMICAL STEEL LADDER CART



- Heavy duty steel construction
- Extended loop handle feature provides additional safety
- Spring activated ladder
- Front swivel caster and ridged rear casters
- Weight: 96 lbs
- Order # 8000546
48" L x 20" W x 61" H

ALUMINUM FLAT SHELF LADDER CART



- Aluminum, light weight design
- Extended loop handle provides additional safety
- Flat shelves with lips up
- Optional, removable middle shelf
- Weight: 102 lbs
- Order # 8041393
60" L x 24" W x 60" H

FOB
St. Charles, MO

HAND TRUCKS & CARTS

Proven Pulling Power

Towing is tough on motorized tuggers and operators. Crown's line of tuggers provide the pulling power and strength needed to significantly improve throughput while transporting heavy loads. Crown tuggers can fulfill many needs.



Replenishing parts to a manufacturing line utilizing a mother/daughter cart system.



Delivering multiple items on a trailer/train system.



Towing long heavy loads on a trailer.

CROWN

TOUGH. DURABLE. DEPENDABLE.

Order Picking Platform *Solutions* to Keep Your Business *Moving Forward*



SAFETY FEATURES



Forkguides with Stirrups
Prevents tipping off electric order picker



Hardwood Clamp Block
Allows secure attachment to electric order picker



Flush Interface
Level & flush alignment prevents tripping and falls

**CUSTOM
DESIGNED WITH YOU
IN MIND**

**WE KEEP
INDUSTRY
MOVING**



HAND TRUCKS & CARTS

MOTHER/DAUGHTER TRAILERS

Create a continuous work-flow with the Nutting Mother/Daughter Trailer System

Nutting
CARTS & TRAILERS

Mother/Daughter Trailers

- The M/D concept uses a tow tractor with a base trailer (mother) from which carts can attach and detach (daughter).
- The key difference between M/D systems and the typical tugger/trailer concept is that the mother remains connected to the tow tractor during cart exchange, so only the daughter carts move.
- The daughter carts can be easily detached and attached without having to disconnect and rearrange trailers in the train.
- Benefits include low capital investment, improved productivity and efficiency, and additional routing flexibility.

Product Features

- Robust steel frame construction
- Industrial grade casters and wheels
- Couplers designed to interface with a tow vehicle hitch
- Quality paint finish

Applications

- Warehousing & Distribution
- Manufacturing / Industrial Plants

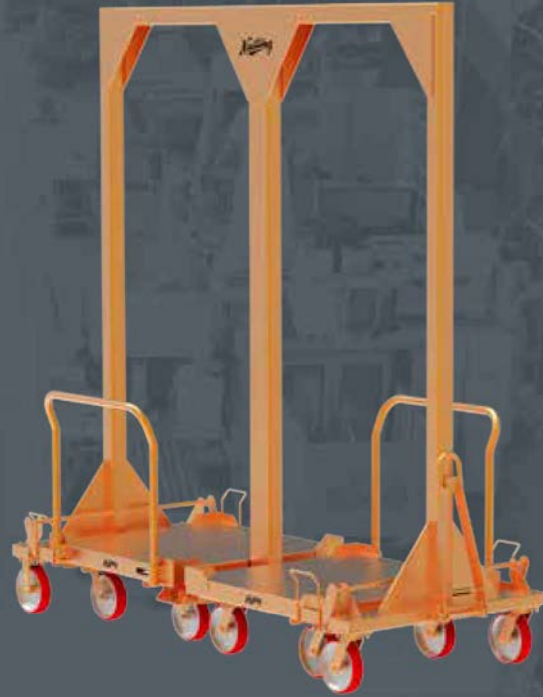

450 Pheasant Ridge Drive • Watertown, SD 57201
1.800.533.0337 • AccoNutting.com





Series 53 Link Caster Steer Carts

Designed for use in distribution centers, warehouses, plants, and terminals. Link caster steering is controlled by a towing tongue with linkage arms connected to specially constructed caster assemblies. This design provides easy, accurate steering plus equal four-point stability even when making turns.

Series 53-007 – Two-wheel steer (dual-steer)

Series 53-007 – Four-wheel steer (quad-steer)

Series 35-007 Order Picking Shelf Carts

Designed specifically for use with electric order pickers for increased productivity and safety. Adjustable shelves. Equipped with swivel and rigid casters. Also available with rigid skid legs for stationary applications or with couplers for towing applications.

Series 52-016 6-Wheel Pivot Steer Carts

Cart will turn in own diagonal length – perfect for tight confines. This dual-purpose function is particularly important when considering manual positioning requirements for order picking, work station and assembly cell replenishment, lean manufacturing, and other material handling applications. Economical alternative to quad-steer trailers.

A. Series 53-007 – Two-Wheel Link Caster Steer

Can be custom made to your specifications; call for details

8" x 2" WHEELS - CAPACITY 2000 LBS. - STEEL DECK

CAT. NO.	DECK SIZE		LBS.
	W	L	
53-007-DS	36"	72"	800



A.

B. Series 53-007 – Four-Wheel Link Caster Steer

Can be custom made to your specifications; call for details

8" x 2" WHEELS - CAPACITY 2000 LBS. - STEEL DECK

CAT. NO.	DECK SIZE		LBS.
	W	L	
53-007-QS	36"	72"	850



B.

C. Series 35-007 Order Picking Shelf Carts

Can be custom made to your specifications; call for details

8" x 2" WHEELS - CAPACITY 1500 LBS. - STEEL DECK HEIGHT - ADJUSTABLE SHELVES

CAT. NO.	DECK SIZE		LBS.
	W	L	
35-007-151	42"	48"	535



C.

D. Series 52-016 6-Wheel Pivot Steer Carts

Can be custom made to your specifications; call for details

8" x 2" WHEELS - CAPACITY 2000 LBS. - STEEL DECK

CAT. NO.	DECK SIZE		LBS.
	W	L	
52-016-008	36"	72"	300



D.

E. Series 52-016 6-Wheel Pivot Steer Carts with Adjustable Shelves

Can be custom made to your specifications; call for details

8" x 2" WHEELS - CAPACITY 2000 LBS. - STEEL DECK

CAT. NO.	DECK SIZE		LBS.
	W	L	
52-016-005	36"	72"	530



E.

SHIPPING INFORMATION: 4-6 Weeks, F.O.B. Watertown, SD



99664C



A. Order Picker Platforms

Units include two solid aluminum shelves that allow boxes and totes to slide for easy loading and unloading. Heavy duty shelves are easily added, removed, or repositioned to maximize efficiency. Shelves are angled back towards the sides to keep picked items contained.

- Lightweight amplimesh sides keep product contained without obstructing the operator's view.
- Aluminum fork pocket includes a replaceable, solid oak "lock block".
- Equipped with handle and heavy-duty casters for manual maneuvering.
- Anti-slip tape on platform and shelves.
- Can be customized to fit your individual picking needs.

CAT. NO.	SIZE (W-H-D)	DH	NET LBS.	SHIP LBS.
THREE ADJUSTABLE SHELVES • 24"D x 36¾"W • ADJUSTABLE ON 4" CENTERS				
98852C	40" x 89" x 48"	5¼"	284	369
TWO ADJUSTABLE SHELVES • 32"D x 36¾"W • ADJUSTABLE ON 4" CENTERS				
99418C	40" x 89" x 48"	5¼"	294	376
TWO SLIDE-IN SHELVES • 30"D • SHELF GUIDES SPACED ON 11¼" CENTERS				
99664C	40" x 77" x 48"	5¼"	293	410
ADDITIONAL SHELVES FOR 99664C				
99664S15	36¼" x 1½" x 15"			15
99664S30	36¼" x 1½" x 30"			30

Equipped with four 6" plate type casters; two rigid, two swivel with brake.

"DH" is the measurement from the top of the fork to the top of the deck.

Comes equipped with Oak Clamp Block, 1½" thick, 3½" tall, 12" long and Anti-Tip Bracket. Custom Sizes Available.

B. Raised Picking Pallet

Ergonomic raised solid platform for easier loading and unloading.

- Aluminum fork pocket includes a replaceable, solid oak "lock block".
- Can be customized to fit your individual picking needs.



99566

CAT. NO.	SIZE (W-H-D)	SHIP LBS.
RAISED PICKING PALLET		
99566	45" x 36" x 43½"	165
MOBILE RAISED PICKING PALLET		
50263	40" x 40" x 49½"	195
INVENTORY PALLET		
51901	43½" x 53¼" x 45"	165

Custom Sizes Available.



51901

50263

C. Case Pick/Put Away Order Picking Cart

This cart is designed to work with an order picker to fulfill your picking needs. With this unique design no picking job is too big or too small. With the fold-up shelf this cart can accommodate large items, or small items with the shelf in the down position.

MODEL NO.	SIZE W-H-D	NO. OF SHELVES	PRODUCT LBS.	SHIP LBS.
98909	53" x 74¾" x 40¼"	2	210	283

Four, 6" plate type swivel casters with brake.

Note: Product is palletized for shipment to prevent damage.

Weight Capacities: Shelf = 500 lbs.
Base = 1,500 lbs.



Shelf folds up to accommodate larger items.

Take it to the **NEXT LEVEL** With New Age **CUSTOMIZATION.**

NEW AGE
INDUSTRIAL
NEW AGE

Made in the USA 

New Age has the additional ability to customize the design and features of their **Order Picking Carts** - Taking them to a new level of innovation over traditional order fulfillment equipment.

The adaptability of the **New Age Order Picking Carts**, through their advanced design upgrades, has made them an in-demand piece of equipment for order pickers in warehouses worldwide.



It's All In The Details.

Our manufacturing process allows you to customize the details that really matter; Such as repositional dividers, scanner holders, and much more.



Made to Order With Your..

- Deck Size, Height, and Pockets.
- Handle Preference.
- Requested Features.



DWG50291

Don't Compromise, Customize.

Products that adapt to your needs and requirements.



DWG99139

Made Your Way...

- Steel or Wood Block?
- Fork Pockets or Open?
- Standard or Heavy Duty Casters?
- Applimesh or Tubular Sides?



DWG53521C

**Contact Your Crown Representative To
Get Started Today!**

HAND TRUCKS & CARTS

Mid-States

MATERIAL HANDLING EQUIPMENT



Order Picking Carts

- 4 x 4 wire mesh panels
- Ergonomic push handle(s)
- Heavy-duty floor lock
- Extended swivel lead on casters
- Fork guides and grabber bars standard
- Grabber bar options:
 - Std. 2 x 4 pine
 - Solid 2 x 4 oak
 - Composite rubber
 - Steel

*Can be custom made to your specifications;
Call Crown for details and pricing.*

Hitch stores away vertically when not in use;
towing ability with rear receiver.



MSOPCR-2-604058

Two upper shelves;
no hitch.



MSOPCR-3-504287

Three upper shelves; no hitch;
two ergonomic handles;
no-slip grit tape on front

CAT. NO.	DECK SIZE	OVERALL HEIGHT	CAPACITY		LBS.	CASTER SIZE	CASTER SIZE
			OVERALL	PER SHELF			
MSOPCR-0-604768	60" x 47"	68"	2000	—	450	8" x 2"	Polyurethane
MSOPCR-2-604058	60" x 40"	58"	2000	250/ea.	460	8" x 2"	Polyurethane
MSOPCR-3-504287	50" x 42"	87"	1000	250/ea.	425	5" x 2"	Rubber

All attachments require a new lift truck capacity data tag. Please contact your local Crown representative.

WARNING: Cancer - www.P65Warnings.ca.gov

SHIPPING INFORMATION: 4-6 Weeks, F.O.B. Milton, IA



350 Series Trucks

6" x 2" Wheels - Capacity 1500 lbs - Deck Height 9"

Includes Standard Safety "T" Handle, Mold on Rubber Wheels

CAT. NO.	DECK SIZE		LBS.
	W X L		
350RR3660	36" x 60"		240
350RR3672	36" x 72"		258
350RR4896	48" x 96"		301

Can be custom made to your specifications; Call Crown for details. **WARNING:** Cancer - www.P65Warnings.ca.gov

352 Series Trucks

8" x 2½" Wheels - Capacity 2500 lbs - Deck Height 11"

Includes Standard Safety "T" Handle, Mold on Rubber Wheels

CAT. NO.	DECK SIZE		LBS.
	W X L		
352RR3660	36" x 60"		262
352RR3672	36" x 72"		280
350RR4896	48" x 96"		343

Can be custom made to your specifications; Call Crown for details. **WARNING:** Cancer - www.P65Warnings.ca.gov

360 Series Trucks

12" x 3½" Wheels - Capacity 5500 lbs - Deck Height 16"

Includes Standard Ring Grip Coupler, Mold on Rubber Wheels

CAT. NO.	DECK SIZE		LBS.
	W X L		
360RR3672	36" x 72"		780
360RR4896	48" x 96"		968
360RR48120	48" x 120"		1064

Can be custom made to your specifications; Call Crown for details. **WARNING:** Cancer - www.P65Warnings.ca.gov

362 Series Trucks

12" x 4" Wheels - Capacity 6500 lbs - Deck Height 16"

Includes Standard Ring Grip Coupler, Mold on Rubber Wheels

CAT. NO.	DECK SIZE		LBS.
	W X L		
362RR3672	36" x 72"		804
362RR4896	48" x 96"		992
362RR48120	48" x 120"		1088

Can be custom made to your specifications; Call Crown for details. **WARNING:** Cancer - www.P65Warnings.ca.gov



HAND TRUCKS & CARTS



Four Wheel Steer with Net Assembly

CAT. NO.	DECK SIZE	WHEEL SIZE	CAPACITY (LBS.)	DECK HEIGHT	LBS.
N3672-8	36" x 72" x 70" OAH	8" x 2½"	2000	11"	560
N3672-12	36" x 72" x 70" OAH	12" x 3"	2000	11"	560

Can be custom made to your specifications; Call Crown for details.

WARNING: Cancer - www.P65Warnings.ca.gov

SHIPPING INFORMATION: 4-6 Weeks, F.O.B. Milton, IA

A. Series 35-007 Order Picking Platform Trucks

Can be custom made to your specifications; call for details

8" x 2" WHEELS - CAPACITY 1500 LBS. - STEEL DECK - REMOVABLE HANDLE

CAT. NO.	DECK SIZE		LBS.
	W	L	
35-007-137	42"	72"	390
35-007-138	42"	96"	440
35-007-139	48"	72"	410
35-007-140	48"	96"	480



B. Series 52-001 Caster Steer Carts

Can be custom made to your specifications; call for details

8" x 2" WHEELS - CAPACITY 1500 LBS. - DECK HEIGHT 12 1/4"

CAT. NO.	DECK SIZE		LBS.
	W	L	
52-001-001	30"	60"	195
52-001-003	36"	72"	235

8" & 10" WHEELS - CAPACITY 2500 LBS. - DECK HEIGHT 14"

CAT. NO.	DECK SIZE		LBS.
	W	L	
52-001-007	30"	60"	240
52-001-009	36"	72"	280

10" & 12" WHEELS - CAPACITY 3000 LBS. - DECK HEIGHT 14 3/4"

CAT. NO.	DECK SIZE		LBS.
	W	L	
52-001-010	30"	60"	270
52-001-012	36"	72"	315

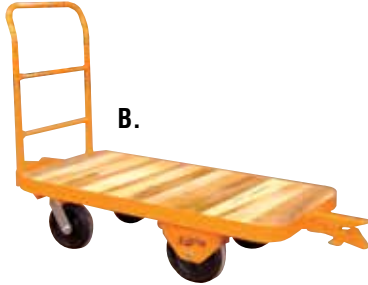

C. Series 54-007 Single Fifth Wheel Steer Carts

Can be custom made to your specifications; call for details

8" x 2" WHEELS - CAPACITY 1000 LBS. - DECK HEIGHT 12 1/2"

CAT. NO.	DECK SIZE		LBS.
	W	L	
54-007-099	36"	60"	540
54-007-100	36"	72"	605
54-007-101	48"	96"	670

8" x 2 1/2" WHEELS - CAPACITY 2000 LBS. - DECK HEIGHT 12 1/2"

CAT. NO.	DECK SIZE		LBS.
	W	L	
54-007-102	36"	60"	545
54-007-103	36"	72"	610
54-007-104	48"	96"	675



D. Series 54-006 Double Fifth Wheel Steer Carts

Can be custom made to your specifications; call for details

8" x 2" WHEELS - CAPACITY 1000 LBS. - DECK HEIGHT 12 1/2"

CAT. NO.	DECK SIZE		LBS.
	W	L	
54-006-223	36"	60"	595
54-006-224	36"	72"	660
54-006-225	48"	96"	705

8" x 2 1/2" WHEELS - CAPACITY 2000 LBS. - DECK HEIGHT 12 1/2"

CAT. NO.	DECK SIZE		LBS.
	W	L	
54-006-226	36"	60"	600
54-006-227	36"	72"	665
54-006-228	48"	96"	710



Custom carts available upon request



Series 35-007 custom model



Series 52 custom cart



Series 54 custom cart



Innovative Ideas in Motion!

Series 35 Order Picking Platform Trucks

Designed specifically for use with electric order pickers for increased productivity and safety. All models include safety features — forkguides with stirrups, hardwood clamp block, and flush deck interface between platform and electric order picker. Standard models available with swivel and rigid casters for mobile applications. Also available with rigid skid legs for stationary applications or with couplers for towing applications.

Series 52 Caster Steer Carts

Specially designed for use on good surfaces in distribution centers, warehouses, industrial plants and terminals. Carts turn by swiveling on the front caster wheels. Two rigid casters are mounted in the back. The most popular of the four basic steer types, caster steer carts have excellent trailing characteristics and have rounded corners for safety and to prevent interlocking on sharp turns.

Series 54 Fifth Wheel Steer Carts

Designed for docks, distribution centers, warehouses, plants and terminals. Carts turn by means of a fifth wheel (turntable) assembly utilizing a precision ball bearing for ease of maneuverability.

Series 54-007 – Single Fifth Wheel Steer (two-wheel steer)

Series 54-006 – Double Fifth Wheel Steer (four-wheel steer)

SHIPPING INFORMATION:
4-6 Weeks, F.O.B. Watertown, SD



Call Your Crown
Representative
for Pricing

The Top Mother/Daughter Tugger Cart System In America!

As an Authorized Reseller for Jtec, Crown can offer customers the best pricing available.

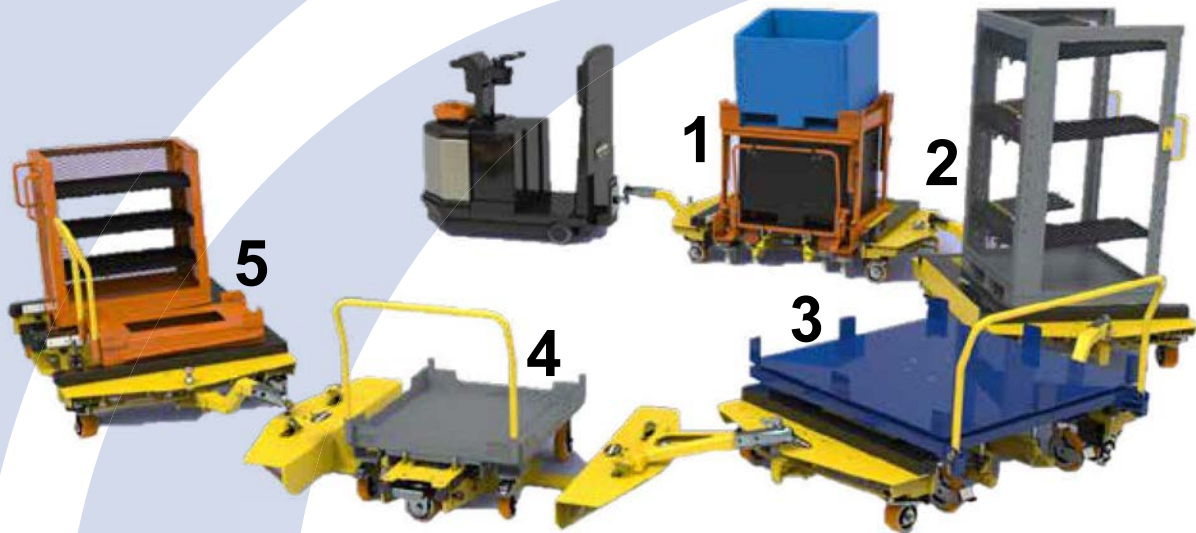

Shown: Crown TR4500 Series tugger pulling a five-cart CarryMore® train:

- 1** CarryMore® Mother Cart with CarryMore Over/Under Daughter Cart. Our most popular Quad-Steer Mother Cart holds up to 4,000 lb. loads. Over/Under Daughter Carts hold two collapsible 30"x32" bins (bottom 25" height, max) with max weight of 1500 lbs. O/U Cart can be used as two Daughter Carts or together as one cart. Doubles lineside space for parts!
Mother Cart #TQSA-40 O/U Cart #RAOU-3032-15
- 2** CarryMore® Mother Cart with CarryMore All-in-One Kit Cart (2017 Product of the Year.) Quad-Steer Mother Cart holds up to 4000 lb loads. All-in-One Kit Cart is mainly used for vertical picking and parts sorting needs. Customizable with fixed shelves, half shelves, lift shelves, drawers, doors, sides, etc. Perfect for Crown Picker Truck use.
Mother Cart #TQSA-40 All-in-One Kit Cart #RAKC-3331-25
- 3** CarryMore® Mother Cart with CarryMore 50"x50" Flatbed Turntable Daughter Cart. Quad-Steer Mother Cart holds up to 4000 lb loads.. Shown with flatbed turntable to present loads to operator side when one side is empty. Unique tilt back handle allows full range of turn without extending deck area.
Mother Cart #TQSA-40 Flatbed Turntable #RATT-5050-25
- 4** CarryMore® Mother Cart with CarryMore 32"x32" Flatbed Daughter Cart. Center-Steer Mother Cart can be loaded or unloaded from either side of the aisle, with up to 3000 lb. loads. This Mother Cart requires good floors as it has just 5/8" floor clearance. Currently flatbeds up to 50"x50" can be used with this Mother Cart.
Mother Cart #TCSHA-30 Flatbed #RAFF-3232-30
- 5** CarryMore® Mother Cart with Dual-Sized Hardware and Mini-Flatbed Daughter Carts. This Quad-Steer Dual Mother Cart can hold up to 4,000 lb. loads with two mini-sized carts measuring up to 25"x50" each or one larger cart measuring up to 72"x50". This versatile cart can be interchanged with Daughter Carts as needed! Both mini-carts shown have 1000 lb. capacity.
Mother Cart #TQDC-40 Mini-Flatbed #RCFO-2650-10 Hardware Cart: #RCKB3-1629-10

Also available:

- Jtec original Center Steer Mother Carts with 2000 lb. max capacity.
- Large Mother Carts for up to 4,000 lb. Dual 50"x50" Daughter Carts.
- Many other Custom Carts. See your Crown Representative for details.



Offering solutions for cart-based material handling using a patented modular concept and customized solutions for both robotics and mechanical cart logistics.

CARTS.



CUSTOMIZATION.

The top structure is optimized for the type of cargo to be carried. It can be anything from a solid steel flatbed for heavy pallets, to an advanced rack for a model-specific assembly kit.

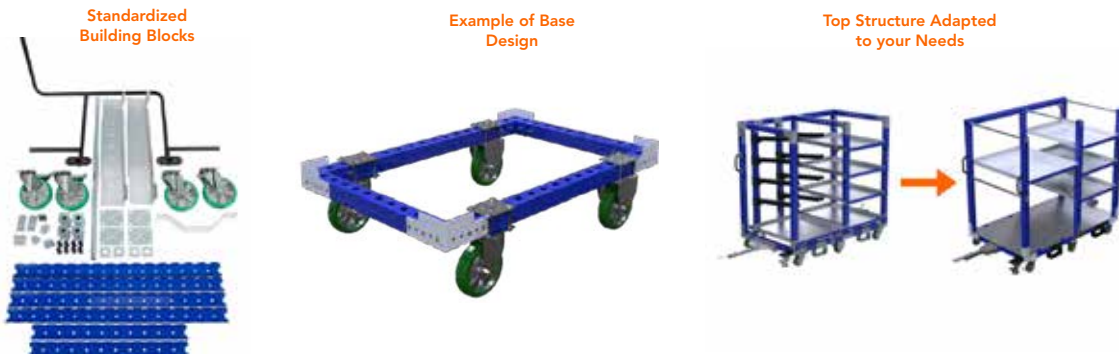

HAND TRUCKS & CARTS

STILL LiftRunner® Tugger Trains.

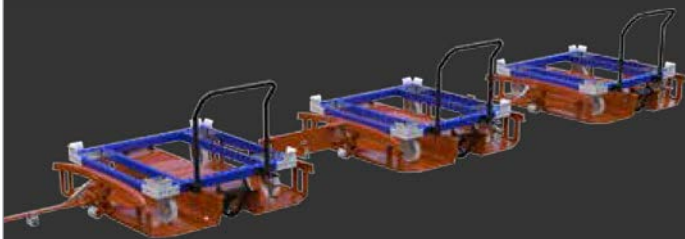

B Frame.

High capacity, with loading and unloading from both sides for maximum flexibility



C Frame.

Flexible usability for indoors & outdoors. Excellent drivability and steering stability.



E Frame.

High drivability & steering stability to guarantee a high level of safety.



HAMILTON®

Caster & Wheel Guide

Caster Options



Field Installable Lock



Side Foot Brake



Welded Swivel Lock

Side Foot Brake - This husky, all-steel wheel brake has been redesigned to be even more positive lock-friendly while accommodating more casters in our series. Stepping down on either end of the pedal produces cam action that locks the wheel. Note: Not available with wheels having tapered bearings.

Swivel Lock - Depending on the caster, either a welded unit or a field installable lock which converts a swivel caster to a rigid one for straight line steering.

Wheel Types



Duralast®



Ergo-Tech®



Metal



Forged Steel



Phenolic

Duralast® - Hamilton's protective wheel that wears like steel. Approximately 1/2" polyurethane tread is liquid cast and chemically bonded onto a heavy-duty iron wheel center. The distinctive green treads are chemically inert, non-sparking, non-conductive, impervious to ozone, grease and most oils & solvents, and will not mark floors.

Ergo-Tech® - These wheels are an ergonomist's favorite and designed to minimize push/pull forces and reduce the risk of work-related injuries. The unique donut-type tread combines with maintenance-free precision ball bearings and provides minimal rolling resistance.

Metal - The most popular metal wheel sizes have larger hubs and thicker cross sections and represent the most durable metal wheels in the industry.

Forged Steel - Forging technology produces the ultimate tensile strength and virtually indestructible industrial wheels.

Phenolic - Fiber-filled phenolic resin, molded under extreme pressure, gives Hamilton Plastex wheels the ability to carry heavy loads without damaging floors in intermittent service. They are non-marking, resist corrosion from oil, water, grease and commonly used acids or solvents, and will not spark.



Standard Duty Casters

Swivel Construction - formed steel mounting plate and horn base; legs 1/4" x 2" plate steel, contoured and continuously welded to horn base. Kingpin - 5/8" diameter orbitally formed rivet. Main Load Bearing - Hardened and polished steel balls rotate in two heat treated raceways. Axle - 1/2" dia. hex head with lock nut. Top plate - 4" x 4 1/2". Bolt holes - Slotted 2 5/8" x 3 3/8" to 3" x 3". Wheels are 2" wide. Finish - Zinc plated. Optional Field Installable 4-Position Swivel Lock: Model No: 4SL-52. Call for availability.

WHEEL TYPE	LOAD CAP. LBS.	HT.	DIA.	SWIVEL CASTER CAT. NO.	SWIVEL CASTER W/ SIDE FOOT BRAKE CAT. NO.	RIGID CASTER CAT. NO.	RIGID CASTER W/ SIDE FOOT BRAKE CAT. NO.
Duralast®	750	5 5/8"	4"	S-524-DB	S-524-DB-FB	R-524-DB	R-524-DB-FB
Ergo-Tech®	450	5 5/8"	4"	S-524-EMB	S-524-EMB-FB	R-524-EMB	R-524-EMB-FB
Rubber	300	5 5/8"	4"	S-524-R	S-524-R-FB	R-524-R	R-524-R-FB
Metal	1000	5 5/8"	4"	S-524-MB	S-524-MB-FB	R-524-MB	R-524-MB-FB
Phenolic	700	5 5/8"	4"	S-524-P	S-524-P-FB	R-524-P	R-524-P-FB
Duralast®	1200	7 1/2"	6"	S-526-DB	S-526-DB-FB	R-526-DB	R-526-DB-FB
Ergo-Tech®	800	7 1/2"	6"	S-526-EMB	S-526-EMB-FB	R-526-EMB	R-526-EMB-FB
Phenolic	1200	7 1/2"	6"	S-526-P	S-526-P-FB	R-526-P	R-526-P-FB
Rubber	1400	7 1/2"	6"	S-526-R	S-526-R-FB	R-526-R	R-526-R-FB
Metal	2000	7 1/2"	6"	S-526-MB	S-526-MB-FB	R-526-MB	R-526-MB-FB
Duralast®	1500	9 1/2"	8"	S-528-DB	S-528-DB-FB	R-528-DB	R-528-DB-FB
Ergo-Tech®	1000	9 1/2"	8"	S-528-EMB	S-528-EMB-FB	R-528-EMB	R-528-EMB-FB
Phenolic	1400	9 1/2"	8"	S-528-P	S-528-P-FB	R-528-P	R-528-P-FB
Metal	1500	9 1/2"	8"	S-528-MB	S-528-MB-FB	R-528-MB	R-528-MB-FB
Rubber	1500	9 1/2"	8"	S-528-R	S-528-R-FB	R-528-R	R-528-R-FB



Workhorse Casters

Swivel Construction - 1/4" thick drop forged steel mounting plate. Kingpin - Sturdy 3/4" dia. integrally forged with mounting plate guaranteed for life not to bend or break. Main Load Bearing - CNC-machined 2 9/16" diameter raceway; 3/8" diameter hardened and polished steel balls. Secondary Load Bearing - 3/4" precision tapered automotive thrust bearing counteracts radial thrust. Axle - 1/2" dia. hex head with lock nut. Top plate - 4 1/2" x 5" (Rigid 4" x 4 1/2"). Bolt holes - Slotted 2 5/8" x 3 3/8" to 3" x 3". Wheels are 2" wide. Finish - Platinum Powder. Optional Accessories - other wheels and options available; contact your Crown representative for assistance.

WHEEL TYPE	LOAD CAP. LBS.	HT.	DIA.	SWIVEL CASTER CAT. NO.	SWIVEL CASTER W/ 4-POS. SWIVEL LOCK CAT. NO.	SWIVEL CASTER W/ SIDE FOOT BRAKE CAT. NO.	RIGID CASTER CAT. NO.	RIGID CASTER W/ SIDE FOOT BRAKE CAT. NO.
Duralast®	750	5 5/8"	4"	S-WH-4DB	S-WH-4DB-4SL	S-WH-4DB-FB	R-WH-R-WH-4DB	R-WH-4DB-FB
Ergo-Tech®	450	5 5/8"	4"	S-WH-42EMB	S-WH-42EMB-4SL	S-WH-42EMB-FB	R-WH-42EMB	R-WH-42EMB-FB
Metal	1000	5 5/8"	4"	S-WH-4MB	S-WH-4MB-4SL	S-WH-4MB-FB	R-WH-4MB	R-WH-4MB-FB
Phenolic	700	5 5/8"	4"	S-WH-4P	S-WH-4P-4SL	S-WH-4P-FB	R-WH-4P	R-WH-4P-FB
Duralast®	1200	7 1/2"	6"	S-WH-6DB	S-WH-6DB-4SL	S-WH-6DB-FB	R-WH-6DB	R-WH-6DB-FB
Ergo-Tech®	800	7 1/2"	6"	S-WH-62EMB	S-WH-62EMB-4SL	S-WH-62EMB-FB	R-WH-62EMB	R-WH-62EMB-FB
Metal	1400	7 1/2"	6"	S-WH-6MB	S-WH-6MB-4SL	S-WH-6MB-FB	R-WH-6MB	R-WH-6MB-FB
Phenolic	1200	7 1/2"	6"	S-WH-6P	S-WH-6P-4SL	S-WH-6P-FB	R-WH-6P	R-WH-6P-FB
Forged Steel	1400	7 1/2"	6"	S-WH-6FSB	S-WH-6FSB-4SL	S-WH-6FSB-FB	R-WH-6FSB	R-WH-6FSB-FB
Duralast®	1500	9 1/2"	8"	S-WH-8DB	S-WH-8DB-4SL	S-WH-8DB-FB	R-WH-8DB	R-WH-8DB-FB
Ergo-Tech®	1000	9 1/2"	8"	S-WH-82EMB	S-WH-82EMB-4SL	S-WH-82EMB-FB	R-WH-82EMB	R-WH-82EMB-FB
Plastex	1400	9 1/2"	8"	S-WH-8P	S-WH-8P-4SL	S-WH-8P-FB	R-WH-8P	R-WH-8P-FB
Metal	500	9 1/2"	8"	S-WH-8MB	S-WH-8MB-4SL	S-WH-8MB-FB	R-WH-8MB	R-WH-8MB-FB



Heavy Service Casters

Swivel Construction - 5/16" thick drop forged steel mounting plate (rigid plate 1/4" thick). Legs - 1/4" x 2" plate steel legs robotically welded inside and outside to forged steel horn base. Kingpin - Sturdy 3/4" dia. integrally forged with mounting plate guaranteed for life not to bend or break. Main Load Bearing - CNC-machined 3/4" diameter raceway; 3/8" diameter hardened and polished steel balls. Secondary Load Bearing - 3/4" precision tapered automotive thrust bearing counteracts radial thrust. Axle - 1/2" dia. hex head with lock nut; Top plate - 4 1/2" x 6 1/2". Bolt holes - Slotted 2 1/8" x 4 1/8" to 3 3/8" x 5 1/4". Wheels are 2" wide. Finish - Crimson Powder. Optional Accessories - other wheels and options available; contact your Crown representative for assistance.

WHEEL TYPE	LOAD CAP. LBS.	HT.	DIA.	SWIVEL CASTER CAT. NO.	SWIVEL CASTER W/ 4-POS. SWIVEL LOCK CAT. NO.	SWIVEL CASTER W/ SIDE FOOT BRAKE CAT. NO.	RIGID CASTER CAT. NO.	RIGID CASTER W/ SIDE FOOT BRAKE CAT. NO.
Duralast®	750	5 5/8"	4"	S-HS-4DB	S-HS-4DB-4SL	S-HS-4DB-FB	R-HS-R-HS-4DB	R-HS-4DB-FB
Ergo-Tech®	450	5 5/8"	4"	S-HS-42EMB	S-HS-42EMB-4SL	S-HS-42EMB-FB	R-HS-42EMB	R-HS-42EMB-FB
Metal	1000	5 5/8"	4"	S-HS-4MB	S-HS-4MB-4SL	S-HS-4MB-FB	R-HS-4MB	R-HS-4MB-FB
Phenolic	800	5 5/8"	4"	S-HS-4P	S-HS-4P-4SL	S-HS-4P-FB	R-HS-4P	R-HS-4P-FB
Duralast®	1200	7 3/4"	6"	S-HS-6DB	S-HS-6DB-4SL	S-HS-6DB-FB	R-HS-6DB	R-HS-6DB-FB
Ergo-Tech®	800	7 3/4"	6"	S-HS-62EMB	S-HS-62EMB-4SL	S-HS-62EMB-FB	R-HS-62EMB	R-HS-62EMB-FB
Forged Steel	2000	7 3/4"	6"	S-HS-6FSB	S-HS-6FSB-4SL	S-HS-6FSB-FB	R-HS-6FSB	R-HS-6FSB-FB
Metal	1400	7 3/4"	6"	S-HS-6MB	S-HS-6MB-4SL	S-HS-6MB-FB	R-HS-6MB	R-HS-6MB-FB
Phenolic	1200	7 3/4"	6"	S-HS-6P	S-HS-6P-4SL	S-HS-6P-FB	R-HS-6P	R-HS-6P-FB
Duralast®	1500	9 3/4"	8"	S-HS-8DB	S-HS-8DB-4SL	S-HS-8DB-FB	R-HS-8DB	R-HS-8DB-FB
Ergo-Tech®	1000	9 3/4"	8"	S-HS-82EMB	S-HS-82EMB-4SL	S-HS-82EMB-FB	R-HS-82EMB	R-HS-82EMB-FB
Metal	1500	9 3/4"	8"	S-HS-8MB	S-HS-8MB-4SL	S-HS-8MB-FB	R-HS-8MB	R-HS-8MB-FB
Phenolic	1400	9 3/4"	8"	S-HS-8P	S-HS-8P-4SL	S-HS-8P-FB	R-HS-8P	R-HS-8P-FB

SHIPPING INFORMATION: Standard Quantities 2 Days ARO/Large Quantities 2-3 Weeks, F.O.B. Hamilton, OH



Champion Casters

Swivel Construction - 1/2" thick drop forged steel top plate and fork base. Legs - 3/8" x 3" plate steel legs welded inside and outside to forged steel horn base. Kingpin - 1" diameter integrally forged kingpin guaranteed for life. Main Load Bearing - 3/4" diameter CNC-machined raceway with hardened polished steel balls. Secondary Load Bearing - 1" precision tapered thrust bearing counteracts thrust. Axle - 3/4" dia. hex head with lock nut. Top plate - 5 1/4" x 7 1/4". Bolt holes - 3 3/8" x 5/4" slotted to 4 1/8" x 6 1/8". Wheels are 3" wide. Finish - Platinum Powder. Optional Accessories - other wheels and options available; contact your Crown representative for assistance.

WHEEL TYPE	LOAD CAP. LBS.	HT.	DIA.	SWIVEL CASTER CAT. NO.	SWIVEL CASTER W/ 4-POS. SWIVEL LOCK CAT. NO.	SWIVEL CASTER W/ SIDE FOOT BRAKE CAT. NO.	RIGID CASTER CAT. NO.	RIGID CASTER W/ SIDE FOOT BRAKE CAT. NO.
Duralast®	2200	8"	6"	S-CH-63DB	S-CH-63DB-4SL	S-CH-63DB-FB	R-CH-63DB	R-CH-63DB-FB
Forged Steel	3500	8"	6"	S-CH-63FSB	S-CH-63FSB-4SL	S-CH-63FSB-FB	R-CH-63FSB	R-CH-63FSB-FB
Metal	2000	8"	6"	S-CH-63MB	S-CH-63MB-4SL	S-CH-63MB-FB	R-CH-63MB	R-CH-63MB-FB
Phenolic	2000	8"	6"	S-CH-63PH	S-CH-63PH-4SL	S-CH-63PH-FB	R-CH-63PH	R-CH-63PH-FB
Duralast®	3500	10 1/2"	8"	S-CH-83DB	S-CH-83DB-4SL	S-CH-83DB-FB	R-CH-83DB	R-CH-83DB-FB
Forged Steel	3500	10 1/2"	8"	S-CH-83FSB	S-CH-83FSB-4SL	S-CH-83FSB-FB	R-CH-83FSB	R-CH-83FSB-FB
Metal	3000	10 1/2"	8"	S-CH-83MB	S-CH-83MB-4SL	S-CH-83MB-FB	R-CH-83MB	R-CH-83MB-FB
Phenolic	3000	10 1/2"	8"	S-CH-83PH	S-CH-83PH-4SL	S-CH-83PH-FB	R-CH-83PH	R-CH-83PH-FB
Duralast®	3000	12 1/2"	10"	S-CH-13DB	S-CH-13DB-4SL	S-CH-13DB-FB	R-CH-13DB	R-CH-13DB-FB
Forged Steel	3500	12 1/2"	10"	S-CH-13FSB	S-CH-13FSB-4SL	S-CH-13FSB-FB	R-CH-13FSB	R-CH-13FSB-FB
Metal	2900	12 1/2"	10"	S-CH-13MH	S-CH-13MH-4SL	S-CH-13MH-FB	R-CH-13MH	R-CH-13MH-FB
Phenolic	2900	12 1/2"	10"	S-CH-13PH	S-CH-13PH-4SL	S-CH-13PH-FB	R-CH-13PH	R-CH-13PH-FB

Duralast® Wheels

Description: Hamilton classic liquid cast 95A polyurethane tread bonded to heavy duty iron center. Wheel Centers - Heavy Duty cast iron. Hardness - 90-95 Durometer (Shore A). Abrasion Resistance - 5-10 times ordinary rubber. Temperature Range - -50° to +200° F intermittent; 0° to 180° F continuous. Featured Wheel Bearing - Precision Ball Bearings: double sealed, maintenance free. Spanner Bushings - Top Hat spanner bushings for 1/2" or 3/4" axle included. Optional Extras - Keyways and/or Set Screws. Other sizes and bearings available.

PRECISION BALL BEARINGS						
CAT. NO.	BEARING SIZE	DIA.	FACE	HUB LENGTH	CAP. LBS.	WT. LBS.
W-420-DB-1/2	1/2"	4"	2	2 1/2"	750	4
W-520-DB-1/2	1/2"	5"	2	2 1/2"	1050	5
W-620-DB-1/2	1/2"	6"	2	2 1/2"	1200	5.75
W-630-DB-3/4	3/4"	6"	3	3 1/2"	2200	10.25
W-820-DB-1/2	1/2"	8"	2	2 1/2"	1500	8.75
W-830-DB-3/4	3/4"	8"	3	3 1/2"	2500	16.75



Ergo-Tech® Wheels

Description: High rollability, liquid cast 87A polyurethane donut tread bonded to aluminum core. Wheel Centers - cast aluminum. Abrasion Resistance - 5-10 times ordinary rubber. Temperature Range - -50° to +200° F intermittent; 0° to 180° F continuous. Featured Wheel Bearing - Precision Ball Bearings: double sealed, maintenance free. Spanner Bushings - Top Hat spanner bushings for 1/2" or 3/4" axle included.

PRECISION BALL BEARINGS						
CAT. NO.	BEARING SIZE	DIA.	FACE	HUB LENGTH	CAP. LBS.	WT. LBS.
W-422-EMB-1/2	1/2"	4"	2	2 1/2"	450	3
W-622-EMB-1/2	1/2"	6"	2	2 1/2"	800	4
W-822-EMB-1/2	1/2"	8"	2	2 1/2"	1000	6



Metal Wheels

Description: Heavy duty cast iron with extra thick hubs, CNC-machined. Made in USA. Featured Wheel Bearing - Precision Ball Bearings: double sealed. Spanner Bushings - Top Hat spanner bushings for 1/2" axle included. Optional Extras - Keyways and/or Set Screws. Other sizes and bearings available.

PRECISION BALL BEARINGS						
CAT. NO.	BEARING SIZE	DIA.	FACE	HUB LENGTH	CAP. LBS.	WT. LBS.
W-420-MB-1/2	1/2"	4"	2	2 1/2"	1000	5
W-620-MB-1/2	1/2"	6"	2	2 1/2"	1400	8
W-820-MB-1/2	1/2"	8"	2	2 1/2"	2500	13



Forged Steel Wheels

Description: Highest capacity drop forged steel tensile strength in the 75,000 psi range. Hardness - 179 (BHN). Temperature Range - -30° to +600° F. Featured Wheel Bearing - Precision Ball Bearings: double sealed, maintenance free. Spanner Bushings - Top Hat spanner bushings for 1/2" or 3/4" axle included. Optional Extras - Keyways and/or Set Screws. Other sizes and bearings available.

PRECISION BALL BEARINGS						
CAT. NO.	BEARING SIZE	DIA.	FACE	HUB LENGTH	CAP. LBS.	WT. LBS.
W-6-FSB-1/2	1/2"	6"	2	2 1/4"	2500	7
W-630-FSB-3/4	3/4"	6"	3	3 1/4"	4000	20
W-830-FSB-3/4	3/4"	8"	3	3 1/4"	7000	27
W-1030-FSB-3/4	3/4"	10"	3	3 1/4"	6500	27



Phenolic Wheels

Description: Fiber-reinforced phenolic resin wheel. Features - Carries heavy loads without damaging floors. Properties - Non-Marking, resists corrosion from oil, water, grease. Temperature range - -50° to 260° F continuous; intermittently to 300° F. Optional Accessories - Wheel bearing seals, spanner bushings, Hi-Heat models. Other sizes and bearings available.

STRAIGHT ROLLER BEARINGS						
CAT. NO.	BEARING SIZE	DIA.	FACE	HUB LENGTH	CAP. LBS.	WT. LBS.
W-420-P-3/4	3/4"	4"	2	2 1/4"	800	2
W-520-P-3/4	3/4"	5"	2	2 1/4"	1000	2
W-620-P-3/4	3/4"	6"	2	2 1/4"	1200	3
W-630-P-1	1"	6"	3	3 1/4"	2000	6
W-830-P-1	1"	8"	3	3 1/4"	3000	10



SHIPPING INFORMATION: Standard Quantities 2 Days ARO/Large Quantities 2-3 Weeks, F.O.B. Hamilton, OH



ORDER PICKER PLATFORMS



Aluminum w/ Rails



Steel w/ Rails



Steel w/ Mesh Rails



Steel w/ End Rail



Rubber Deck



2 Shelf Unit



Aluminum w/ End Rail

AVAILABLE IN STEEL OR ALUMINUM

MODEL	SIZE	CAPACITY	MODEL	SIZE	CAPACITY
OP-3648	36"W x 48"L	1,500 lbs,	OP-4272	42"W x 72"L	1,500 lbs,
OP-3660	36"W x 60"L	1,500 lbs,	OP-4296	42"W x 96"L	1,500 lbs,
OP-4048	40"W x 48"L	1,500 lbs,	OP-4848	48"W x 48"L	1,500 lbs,
OP-4060	40"W x 60"L	1,500 lbs,	OP-4860	48"W x 60"L	1,500 lbs,
OP-4072	40"W x 72"L	1,500 lbs,	OP-4872	48"W x 72"L	1,500 lbs,
OP-4248	42"W x 48"L	1,500 lbs,	OP-4896	48"W x 96"L	1,500 lbs,
OP-4260	42"W x 60"L	1,500 lbs,	OP-6096	60"W x 96"L	1,500 lbs,

Order picker platforms are custom built to meet the specs of your order picker. The sizes and options you see in the tables are the most common. Custom sizes and features are available upon request.

Our order pickers are made in either steel or aluminum and provide a solid, smooth top deck on which to place picked orders.

HAND TRUCKS & CARTS

OPTIONS	DESCRIPTION
OP-H-RAIL	42"H Rail-Fixed
OP-H-REM	Add-On to make Rail Removable
OP-H-MESH	Add Mesh to Rail
OP-H-FOLD	Add-On to make Rails Fold Down
OP-H-HD	Heavy Duty Rail Add-On
OP-O-DESK	36"H Standing Desk with 3"Lip
OP-O-DPLT	Diamond Plate Deck
OP-O-FL	Floor Lock
OP-O-SH2	2 Shelf Unit, Mesh Enclosed
OP-O-SH3	3 Shelf Unit, Mesh Enclosed
OP-H-PUSH	Push Handle
OP-C-5P	Premium 5" x 2" Polyurethane Casters
OP-O-SKTP	6"W Anti-Skid Tape
OP-O-TOW	Tow Bar Assembly
OP-O-RDK	Rubber Deck



Anti-Skid Tape



Diamondplate Deck



Desk

- Built to Order
- Full Length Fork Pockets
- Wood Block for Pallet Clamp
- Standard Capacity: 1,500 LBS
- Full Frame Construction
- Solid 11ga. Deck



Push Handle



Floor Lock



Casters



Select your Platform Size					
Model	Cap.	Size	Model	Cap.	Size
ORDPK3648	1500lbs.	36x48	ORDPK4272	1500lbs.	42x72
ORDPK3660	1500lbs.	36x60	ORDPK4296	1500lbs.	42x96
ORDPK4048	1500lbs.	40x48	ORDPK4848	1500lbs.	48x48
ORDPK4060	1500lbs.	40x60	ORDPK4860	1500lbs.	48x60
ORDPK4072	1500lbs.	40x72	ORDPK4872	1500lbs.	48x72
ORDPK4248	1500lbs.	42x48	ORDPK4896	1500lbs.	48x96
ORDPK4260	1500lbs.	42x60	ORDPK6096	1500lbs.	60x96

Select your Material		
Steel	Aluminum	Stainless Steel

Select your Options	
Option	Description
ORD-Erail	42"H End Rail-Fixed
ORD-Srail	42"H Side Rail-Fixed-each
ORD-Rem	Removable Rail Option-each
ORD-2 Shelf	2 shelves, mesh enclosed
ORD-3 Shelf	3 shelves, mesh enclosed
ORD-Cas ST	standard 5x2 casters (2 Rigid, 2 Swivel)
ORD- Cas HD	Premium 5x2 casters (2 Rigid, 2 Swivel)
ORD-SKTape	6" wide traction grip tape
ORD-Mesh E	Add mesh to End Rail
ORD-Mesh S	Add mesh to Side Rail
ORD-Tow	Tow bar
ORD-Towcs	Premium radius tow casters



WARNING: Cancer and reproductive harm - www.P65Warnings.ca.gov

All attachments require a new lift truck capacity data tag. Please contact your local Crown representative.



Order Picker Platforms

Order Picker Platforms can be customized to fit your individual needs. From shelves to removable sides to towing, we can design the proper platform for you. Contact your Crown representative.

HAND TRUCKS & CARTS

Single Man Maintenance Cage

- Fork channels are on 25" centers with full length tube openings of 7" x 2 3/4"
- There are safety pins behind each fork and heavy duty chains welded to back frame of platform which secure around fork carriage
- Also available fitted with casters, back riser, tool tray and light bulb caddy
- Painted Safety Yellow

CAT. NO.	DESCRIPTION	CAPACITY (LBS.)	DIMENSIONS (L X W X H)	WEIGHT (LBS.)
184002	Standard Work Platform	1000	40" x 40" x 63"	203

OPTIONS

184003	Set of (4) 3" Polyolefin Casters Installed	—	—	6
184004	High Back Riser w/Mounting Hardware	—	40 1/2" x 10 3/4" x 24"	23
184005	Light Bulb Caddy	—	9 3/4" x 10 3/4" x 38"	26
184006	Tool Tray	—	6" x 37 1/8" x 2"	11

SHIPPING INFORMATION: 3 Weeks, F.O.B. Litchfield MI



Photo shown with options included



Single Man Maintenance Cage

Convert your forklift into a work platform. Base and 4" side curbs are formed from one piece of heavy gauge sheet for extra strength. Back panel is 1/2-#13 expanded metal mesh. Deck has a slip resistant surface. Hinged gate with pin safety lock built in for extra security.

All attachments require a new lift truck capacity data tag. Please contact your local Crown representative.



Ultra Stack and Hang Bins

Organize your inventory with strong injection-molded plastic bins. Front, back and side grips for easy handling. Built-in rear hanger allows bins to hang from louvered panels or rails. Optional clear plastic window increases bin capacity and provides quick view of bin contents. Dividers maximize flexibility and keep contents organized. Wide stacking ledge and anti-slide lock keep stacked bins steady and prevent forward shifting. Waterproof bins resist rust and corrosion. Large molded front label slots for ID labels. Available in blue, yellow, red, green, ivory and black.

Economy Shelf Bins

Replace worn out corrugated bins permanently with these tough, durable, high-density plastic bins. These polypropylene bins are 4" high and feature a molded-in label holder, built-in rear hanglock which allows bins to tilt out for complete access when on shelving. A wide hopper front allows complete access to the contents of the bins. Edges are reinforced for added strength. Available in blue, yellow, red, green, ivory and black.

Bin Cups

Available in two sizes: 3¼" x 1¾" x 3" and 5½" x 2¾" x 3" and two colors: blue and yellow.

CAT. NO.	QTY./PACK	LBS.
QBC111	48	4
QBC112	48	7



Ultra Stack and Hang Bins

CAT. NO.	OUTSIDE L X W X H	INSIDE L X W	BIN LOAD			CLEAR WINDOW		DIVIDER	
			QTY./PACK	LBS.	CAP. (LBS.)	CAT. NO.	QTY./PACK	CAT. NO.	QTY./PACK
QUS200	5" x 4½" x 3"	4¾" x 3¾"	24	5	8	—	—	DUS200	6
QUS210	5½" x 4½" x 3"	4¾" x 3¾"	24	5	10	—	—	DUS210	6
QUS220	7½" x 4½" x 3"	6¾" x 3¾"	24	8	10	—	—	DUS220	6
QUS221	9¼" x 6" x 5"	8¾" x 5¾"	12	9	20	WUS221	12	DUS221	6
QUS224	10½" x 4½" x 4"	10¼" x 3¾"	12	8	30	WUS224	12	DUS224	6
QUS230	10½" x 5½" x 5"	10¼" x 4¾"	12	10	30	WUS230/234	12	DUS230/235	6
QUS234	14¼" x 5½" x 5"	14¼" x 4¾"	12	13	50	WUS230/234	12	DUS234	6
QUS235	10½" x 11" x 5"	10¼" x 10"	6	10	50	WUS235	6	DUS230/235	6
QUS239	10½" x 8¼" x 7"	10" x 6¾"	6	10	50	WUS239/240	6	DUS239	6
QUS240	14¼" x 8¾" x 7"	14" x 6¾"	12	24	60	WUS239/240	6	DUS240/250	6
QUS241	13½" x 8¼" x 6"	12¾" x 6¾"	12	19	60	WUS241	12	DUS241	6
QUS242	13½" x 8¼" x 8"	12¾" x 6¾"	12	23	60	WUS242	12	DUS242	6
QUS245	10½" x 16½" x 5"	10¼" x 15"	6	13	60	WUS245	6	DUS245	6
QUS250	14¾" x 16½" x 7"	14" x 14¾"	6	21	75	WUS250	6	DUS240/250	6
QUS255	16" x 11" x 8"	15½" x 10"	4	12	75	WUS255	4	DUS255	6
QUS260	18" x 11" x 10"	17½" x 10"	4	19	75	WUS260	4	DUS260	6
QUS265	18" x 8¼" x 9"	17½" x 6¾"	6	17	60	WUS265	6	DUS265	6
QUS270	18" x 16½" x 11"	17½" x 14¾"	3	16	75	WUS270	3	DUS270	6

Labels are available for all Ultra Bins. For cat. no., substitute "L" for Q in bin cat. no. Carton quantity: 50 labels (Cat. No. LUS245).



Economy Shelf Bins

CAT. NO.	OUTSIDE L X W	INSIDE L X W	QTY./PACK		LBS.	DIVIDER	
			QTY./PACK	LBS.		CAT. NO.	QTY./PACK
QSB100	11½" x 2¼"	10¼" x 1½"	36	13	—	—	
QSB101	11½" x 4½"	10¼" x 3"	36	17	DSB101	50	
QSB102	11½" x 6½"	10¼" x 5½"	30	18	DSB102	50	
QSB107	11½" x 8½"	10¼" x 7½"	20	15	DSB107	50	
QSB109	11½" x 11½"	10¼" x 10"	8	7	DSB109	50	
QSB103	17½" x 4½"	16½" x 3"	20	13	DSB103	50	
QSB104	17½" x 6½"	16½" x 5½"	20	16	DSB104	50	
QSB108	17½" x 8½"	16½" x 7½"	10	11	DSB108	50	
QSB110	17½" x 11½"	16½" x 10"	8	11	DSB110	50	
QSB105	23½" x 4½"	22½" x 3"	16	13	DSB105	50	
QSB106	23½" x 6½"	22½" x 5½"	8	9	DSB106	50	
QSB114	23½" x 8½"	22½" x 7½"	6	9	DSB114	50	
QSB116	23½" x 11½"	22½" x 19"	6	10	DSB116	50	

NOTE: Bins also available in 6" high.

Label holders also available.

Labels are available for all shelf bins. For label cat. no., substitute "L" for "Q" in bin cat. no. Carton quantity: 50 labels Cat. No. LUS245).

SHIPPING INFORMATION: 1-2 Weeks, F.O.B. Fresno, CA; Miami, FL; Chicago, IL



Giant Stack Containers

Multipurpose, wide open hopper front provides easy access for large part storage. Ideal for multiple applications in recycling, storing parts, tools and warehouse items. This bin will stack up to six bins high, creating a sturdy, tall storage system. Injection molded from high-density polyethylene, easy to clean, resists rust and corrosion and impervious to most chemicals. Six 1/4" drill hole pattern on bottom of bin allows for easy hole insertion for drainage.

- QGH700 available in gray, blue, red, ivory and black; QGH600 and QGH800 available in gray, blue and red.

CAT. NO.	OUTSIDE DIMENSIONS L X W X H	QTY./PACK	LBS.	CLEAR WINDOW	
				CAT. NO.	QTY./PACK
QGH600	17 1/2" x 10 7/8" x 12 1/2"	4	14	WGH600	4
QGH700*	15 1/4" x 19 7/8" x 12 1/16"	3	14	WGH700	3
QGH800	17 1/2" x 16 1/2" x 12 1/2"	2	10	WGH800	2

*Optional label for QGH700 is available — LGH700 (3 per package).

Rackbin 42" Containers

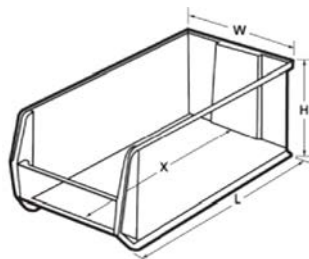

- Waterproof bins are corrosion free
- Available in blue and gray

Rackbin 42" Containers

- Extra large bins offer 42" (3 1/2 feet) in length to store large items
- 42" length ensures no wasted space on 42" deep rack
- Heavy-duty front, back and side grips allow for easy handling
- Wide stacking ledge and anti-slide lock keep stack bins steady and prevent forward shifting
- Has eight 1/4" drill hole pattern on bottom of bin for easy hole insertion for drainage and air circulation if needed

CAT. NO.	OUTSIDE DIMENSIONS L X W X H	INSIDE DIMENSIONS L X W X H	X	CARTON QTY.	CARTON WT. (LBS.)
QRB176MOB	41 7/8" x 16 1/2" x 17 1/2"	40 1/8" x 14" x 16 1/2"	35"	1	18
QRB206	41 7/8" x 19 7/8" x 17 1/2"	40 1/8" x 17 7/8" x 16 1/2"	35"	1	17
QRB216MOB	41 7/8" x 19 7/8" x 17 1/2"	40 1/8" x 17 7/8" x 16 1/2"	35"	1	19
QRB246	41 7/8" x 23 7/8" x 17 1/2"	40 1/8" x 21 1/2" x 16 1/2"	35"	1	19
QRB256MOB	41 7/8" x 23 7/8" x 17 1/2"	40 1/8" x 21 1/2" x 16 1/2"	35"	1	21

*With casters, overall height for mobile container will be increased by 3"



Containers can be divided by length and/or width, allowing a subdivision down to 1/8" square compartment size. Available in gray.



Dividable Grid Containers

- Containers and covers are available in blue, gray and red; covers are also available in clear.

CAT. NO.	OUTSIDE L X W X H	INSIDE L X W X H	QTY./ PACK	LBS.
DG91050	10 7/8" x 8 3/4" x 5"	9 9/16" x 6 5/8" x 4 1/2"	20	32
DG92035	16 1/2" x 10 7/8" x 3 1/2"	14 7/8" x 9 7/8" x 3"	12	23
DG92060	16 1/2" x 10 7/8" x 6"	14 7/8" x 9 7/8" x 5 1/2"	8	20
DG92080	16 1/2" x 10 7/8" x 8"	14 7/8" x 9 7/8" x 7 1/2"	8	27
DG93030	22 1/2" x 17 1/2" x 3"	20 5/8" x 15 5/8" x 2 1/2"	6	20
DG93060	22 1/2" x 17 1/2" x 6"	20 5/8" x 15 5/8" x 5 1/2"	3	19
DG93080	22 1/2" x 17 1/2" x 8"	20 5/8" x 15 5/8" x 7 1/2"	3	16
DG93120	22 1/2" x 17 1/2" x 12"	20 5/8" x 15 5/8" x 11 1/2"	3	23

For long divider, substitute "DL" for "DG" in cat. no.; for short divider, substitute "DS" for "DG" in cat. no. Covers are available.

Dividable Grid Containers

Can be used in industrial, commercial, electronic and health care industries. Safe and efficient compartmentalizing and protecting small to medium sized parts. Dividers allow you to customize the container's interior to meet your exact needs.

SHIPPING INFORMATION:
1-2 Weeks, F.O.B. Fresno, CA;
Miami, FL; Chicago, IL



AKRO-MILS

Polypropylene Storage Bins

Choose from a wide selection of sizes to establish more efficient storage systems in plants, warehouses and maintenance operations.

Bins allow color-coding of like and unlike items for fast identification.

Durable polypropylene won't rust or corrode, remains unaffected by moisture, as well as greases and oils.

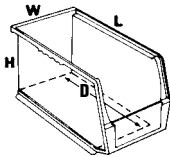

PRODUCT WARRANTY INFORMATION: Akro-Mils warrants the products will be free from defects in material or workmanship for a period of one year from date of purchase.

SHIPPING INFORMATION:
1-2 Days, F.O.B. Warrenville, IL



A. Shelf Bins

Molded of durable polypropylene for years of service. Special built-in hanglock allows easy access to the entire bin. All boxes are 4" high. Wide label holder molded in. Available in red, yellow, blue, white or green. Thirteen sizes to choose from. Bins are seamless, waterproof, and unaffected by grease or oil.

BINS					DIVIDERS		
CAT. NO.	OUTSIDE W X L	INSIDE W X L	QTY./PACK	LBS.	CAT. NO.	PACK	LBS.
30110	2 $\frac{3}{8}$ " x 11 $\frac{1}{8}$ "	1 $\frac{1}{2}$ " x 10 $\frac{1}{4}$ "	24	5	None	-	-
30120	4 $\frac{1}{8}$ " x 11 $\frac{1}{8}$ "	3" x 10 $\frac{1}{4}$ "	24	9	40120	24	1
30124	4 $\frac{1}{8}$ " x 23 $\frac{3}{8}$ "	3" x 22 $\frac{1}{8}$ "	12	11	40120	24	1
30128	4 $\frac{1}{8}$ " x 17 $\frac{1}{8}$ "	3" x 16 $\frac{1}{2}$ "	12	7	40120	24	1
30130	6 $\frac{1}{8}$ " x 11 $\frac{1}{8}$ "	5 $\frac{1}{2}$ " x 10 $\frac{1}{4}$ "	12	7	40130	24	2
30138	6 $\frac{1}{8}$ " x 17 $\frac{1}{8}$ "	5 $\frac{1}{2}$ " x 16 $\frac{1}{2}$ "	12	9	40130	24	2
30150	8 $\frac{1}{8}$ " x 11 $\frac{1}{8}$ "	7 $\frac{1}{8}$ " x 10 $\frac{1}{4}$ "	12	8	40150	24	3
30158	8 $\frac{1}{8}$ " x 17 $\frac{1}{8}$ "	7 $\frac{1}{8}$ " x 16 $\frac{1}{2}$ "	12	12	40150	24	3
30164	6 $\frac{1}{8}$ " x 23 $\frac{3}{8}$ "	5 $\frac{1}{2}$ " x 22 $\frac{1}{8}$ "	6	8	40130	24	2
30170	11 $\frac{1}{8}$ " x 11 $\frac{1}{8}$ "	10" x 10 $\frac{1}{4}$ "	12	11	40170	24	4
30174	11 $\frac{1}{8}$ " x 23 $\frac{3}{8}$ "	10" x 22 $\frac{1}{8}$ "	6	11	40170	24	4
30178	11 $\frac{1}{8}$ " x 17 $\frac{1}{8}$ "	10" x 16 $\frac{1}{2}$ "	12	15	40170	24	4
30184	8 $\frac{1}{8}$ " x 23 $\frac{3}{8}$ "	7 $\frac{1}{8}$ " x 22 $\frac{1}{8}$ "	6	9	40150	24	3

*Please specify color when ordering. Order in carton quantities.

C. Bin Cups

Use to separate items within each Shelf Bin. Plastic Bin Cups come in two sizes, and allow you to remove the entire cup to retrieve parts.

CAT. NO.	FIT BIN NO.	DIMENSIONS	QTY./PACK	LBS.
30101	All	3 $\frac{1}{4}$ " x 2" x 3"	48	4
30102	All except 30110	5" x 2 $\frac{3}{4}$ " x 3"	24	5

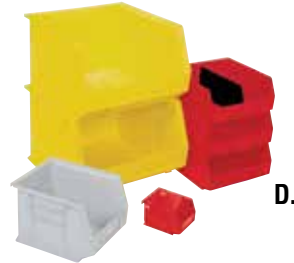

D.

D. Polypropylene Storage Bins

Hang AkroBins securely from louvered panels. Extra-wide stacking ledge assures secure stacking. Anti-slide stop prevents loaded bins from shifting forward when stacked. Large label slot for clear identification. Reinforcing ribs prevent bins from spreading when loaded. Finger grips allow easy handling. Your choice of red, yellow, blue, stone, green, semi-clear and black.

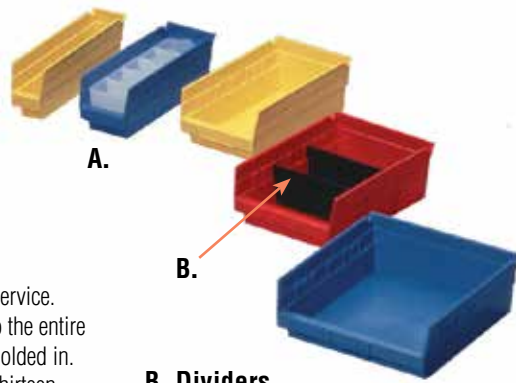

A.

B.

B. Dividers

Dividers are polypropylene and fit all models except 30110. Up to 7 per bin.

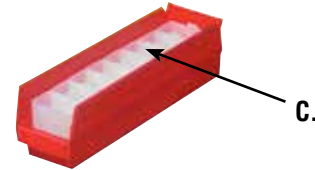

C.



See-through crystal styrene lid keeps contents dust-free and protected (30210, 30220, 30230 and 30235 only).

HANG 'EM OR STACK 'EM

Dividers and lids available. Please call for information and pricing.

CAT. NO.	OUTSIDE L X W X H	INSIDE L X W X H X D	QTY./PACK	LBS.
30210	5 $\frac{1}{8}$ " x 4 $\frac{1}{8}$ " x 3"	4 $\frac{1}{4}$ " x 3 $\frac{1}{16}$ " x 2 $\frac{1}{16}$ " x 4"	24	5
30220	7 $\frac{1}{8}$ " x 4 $\frac{1}{8}$ " x 3"	6 $\frac{1}{4}$ " x 3 $\frac{1}{16}$ " x 2 $\frac{1}{16}$ " x 6"	24	8
30224	10 $\frac{1}{8}$ " x 4 $\frac{1}{8}$ " x 4"	10 $\frac{1}{4}$ " x 3 $\frac{1}{16}$ " x 3 $\frac{1}{4}$ " x 9"	12	7
30230	10 $\frac{1}{8}$ " x 5 $\frac{1}{2}$ " x 5"	10 $\frac{1}{4}$ " x 4 $\frac{1}{8}$ " x 4 $\frac{1}{4}$ " x 9"	12	10
30234	14 $\frac{1}{4}$ " x 5 $\frac{1}{2}$ " x 5"	14 $\frac{1}{16}$ " x 4 $\frac{1}{8}$ " x 4 $\frac{1}{4}$ " x 12 $\frac{1}{16}$ "	12	13
30235	10 $\frac{1}{8}$ " x 11" x 5"	10 $\frac{1}{4}$ " x 10" x 4 $\frac{1}{4}$ " x 9"	6	10
30239	10 $\frac{1}{4}$ " x 8 $\frac{1}{4}$ " x 7"	10" x 6 $\frac{1}{8}$ " x 6 $\frac{1}{8}$ " x 8"	6	10
30240	14 $\frac{1}{4}$ " x 8 $\frac{1}{4}$ " x 7"	14" x 6 $\frac{1}{16}$ " x 6 $\frac{1}{4}$ " x 12"	12	24
30250	14 $\frac{1}{4}$ " x 16 $\frac{1}{2}$ " x 7"	14" x 14 $\frac{1}{4}$ " x 6 $\frac{1}{4}$ " x 12"	6	21
30255	10 $\frac{1}{8}$ " x 16 $\frac{1}{2}$ " x 5"	9 $\frac{3}{4}$ " x 15" x 4 $\frac{1}{4}$ " x 8 $\frac{1}{2}$ "	6	12
30260	18" x 11" x 18"	17" x 9 $\frac{1}{2}$ " x 10" x 14 $\frac{1}{16}$ "	6	18
* 30265	18" x 8 $\frac{1}{4}$ " x 9"	17 $\frac{1}{8}$ " x 6 $\frac{1}{4}$ " x 8 $\frac{1}{4}$ " x 14 $\frac{1}{2}$ "	6	17
* 30270	18" x 16 $\frac{1}{2}$ " x 11"	17 $\frac{1}{8}$ " x 14 $\frac{1}{4}$ " x 10 $\frac{1}{4}$ " x 13 $\frac{1}{4}$ "	3	13

*30265 and 30270 are not designed for use with hanging systems.

Please specify color when ordering. Order in carton quantities.

Bin Systems

A. Louvered Panels can be mounted on walls, or on the back of shelving. Panels provide a versatile structure that lets you build your own AkroBin system. Holds up to 480 lbs.

B. Bench Rack – 8"D; base holds 120 lbs.

CAT. NO.	DESCRIPTION	SIZE (W X H)	QTY./PACK	LBS.
30118	Louvered Panel	18" x 61"	1	30
30161	Louvered Panel	36" x 61"	1	50
30618	Louvered Panel	18" x 19"	4	24
30636	Louvered Panel	36" x 19"	4	47
98600*	Bench Rack	28" x 21"	1	16
98636	Bench Rack	36" x 21"	1	19



A.



B.

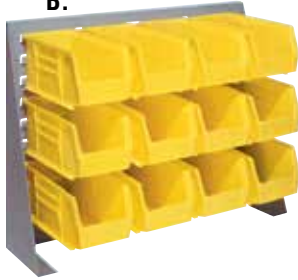

C. Louvered Floor Rack – Holds up to 2000 lbs.

CAT. NO.	DESCRIPTION	SIZE (L X W X H)	QTY./PACK	LBS.
30651	Heavy-Duty Louvered Floor Rack	35 $\frac{3}{4}$ " x 17" x 75 $\frac{1}{2}$ "	1	100
30653	Louvered Floor Rack	35 $\frac{3}{4}$ " x 32" x 75 $\frac{1}{2}$ "	1	182
30661	Louvered Floor Rack	36 $\frac{3}{8}$ " x 13 $\frac{1}{2}$ " x 66 $\frac{3}{8}$ "	1	100

D. Double-Sided Rivet Floor Rack – Holds 700 lbs.

CAT. NO.	DESCRIPTION	SIZE (L X W X H)	QTY./PACK	LBS.
30676	Double-Sided Rivet Floor Rack	36" x 25" x 66 $\frac{3}{8}$ "	1	140

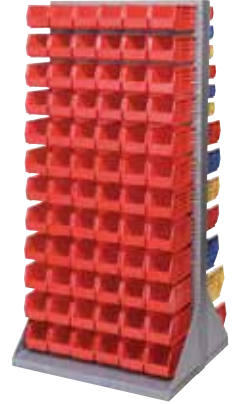

SHIPPING INFORMATION:

1-2 Days, F.O.B. Warrenville, IL

* Item 98600 - 2 Weeks
F.O.B. Warrenville, IL

C.



D.

NOTE: Bins must be ordered separately.

BIN LOAD CAPACITY WHEN ATTACHED TO PANEL

BIN NO.	30210	30220	30224	30230	30234	30235	30239	30240	30250	30255	30320
Cap.	10 lbs.	10 lbs.	30 lbs.	30 lbs.	50 lbs.	50 lbs.	50 lbs.	60 lbs.	75 lbs.	60 lbs.	80 lbs.

QUANTITY OF BINS TO FIT LOUVERED UNITS

CAT NO.	30210	30220	30224	30230	30234	30235	30239	30240	30250	30255	30320
30118	48	48	36	28	28	14	12	12	6	9	–
30161	96	96	72	54	54	28	24	24	12	18	10
30618	16	16	12	9	9	–	–	–	–	3	–
30626	192	192	144	108	108	54	48	48	24	36	–
30636	32	32	24	18	18	9	8	8	4	6	–
30638	48	48	36	28	28	14	12	12	6	9	–
30651	144	144	98	72	72	36	36	36	18	24	11
30653	288	288	192	144	144	72	72	72	36	48	–
30661	96	96	72	54	54	28	24	24	12	18	10
30676	192	192	144	108	108	56	48	48	24	36	20
98600	30	30	18	12	12	6	6	6	–	–	–
98636	40	40	24	18	18	9	8	8	4	6	–



AKRO-MILS

Clear ShelfMax Bins

Clear 6" ShelfMax Bins expand storage capacity up to 85% over standard 4" bins.

- Exclusive rolled top edge for added strength when filled to capacity
- Durable clear polypropylene construction is far superior to corrugated bins
- Width dividers sold separately

Clear Shelf Bins

4" Shelf Bins are the industry standard for quality, durability and value. Bins are molded from durable polypropylene for easy identification of parts and supplies.

- Wide hopper front and molded-in label holder
- Built-in rear hanglock allows bin to tilt out for full access
- Width dividers sold separately

Clear Super-Size AkroBins

20", 24" and 30" deep clear bins for super-size storage. Large-capacity bins for organizing heavy or bulky items.

- Heavy-duty bins molded in clear polypropylene, unaffected by weak acids or alkalis
- Sturdy, one-piece construction is water, rust and corrosion proof
- Extra large stacking containers feature anti-slide stop to prevent bins from shifting forward
- Reinforced side ribs add strength and prevent spreading when stacked or loaded
- Optional window inserts optimize interior space and keep contents visible
- Length and width dividers sold separately
- Available in 12 sizes

Clear Stak-N-Store Bins

Sturdy stacking storage bins for heavy and bulky items. Create tall, stable storage to save floor space. Extra-wide hopper front.

- Rolled top edge for added strength and durability
- Large comfort-grip handles for easy lifting

A. Blue, Clear & Red Bins

CAT. NO.	OUTSIDE DIM. (L X W X H)
30040	11 ⁷ / ₈ " x 4 ¹ / ₈ " x 6"
30048	17 ⁷ / ₈ " x 4 ¹ / ₈ " x 6"
30080	11 ⁷ / ₈ " x 8 ³ / ₈ " x 6"
30088	17 ⁷ / ₈ " x 8 ³ / ₈ " x 6"
30090	11 ⁷ / ₈ " x 6 ⁵ / ₈ " x 6"
30094	23 ³ / ₈ " x 6 ⁵ / ₈ " x 6"
30098	17 ⁷ / ₈ " x 6 ⁵ / ₈ " x 6"



A.

B. Clear Shelf Bins

CAT. NO.	OUTSIDE DIM. (L X W X H)
30110	11 ⁷ / ₈ " x 2 ³ / ₄ " x 4"
30120	11 ⁷ / ₈ " x 4 ¹ / ₈ " x 4"
30130	11 ⁷ / ₈ " x 6 ⁵ / ₈ " x 4"
30150	11 ⁷ / ₈ " x 8 ³ / ₈ " x 4"
30170	11 ⁷ / ₈ " x 11 ¹ / ₈ " x 4"
30128	17 ⁷ / ₈ " x 4 ¹ / ₈ " x 4"
30138	17 ⁷ / ₈ " x 6 ⁵ / ₈ " x 4"
30158	17 ⁷ / ₈ " x 8 ³ / ₈ " x 4"
30178	17 ⁷ / ₈ " x 11 ¹ / ₈ " x 4"
30124	23 ³ / ₈ " x 4 ¹ / ₈ " x 4"
30164	23 ³ / ₈ " x 6 ⁵ / ₈ " x 4"
30184	23 ³ / ₈ " x 8 ³ / ₈ " x 4"
30174	23 ³ / ₈ " x 11 ¹ / ₈ " x 4"

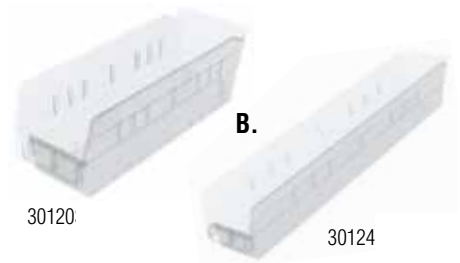

B.

Blue (C.), Yellow (D.) & Red (E.) Shelf Bin Wire Shelving Systems

CAT. NO.	FOR BIN CAT. NO.	QTY/PACK	SHELVES
AWS143630120	30120	96	12
AWS143630130	30130	60	12
AWS143630150	30150	48	12
AWS143630170	30170	36	12
AWS183630128	30128	96	12
AWS183630138	30138	60	12
AWS183630158	30158	48	12
AWS183630178	30178	36	12
AWS24483012A	30124	120	12
AWS244830164	30164	60	12
AWS244830184	30184	48	12
AWS244830174	30174	36	12



C.

D.

E.

SHIPPING INFORMATION:
1-2 Days, F.O.B. Warrenville, IL

F. Clear Super-Size AkroBins

CAT. NO.	OUTSIDE DIM. (L X W X H)	QTY/PACK
30280	20" x 12 ³ / ₈ " x 6"	4
30281	20" x 12 ³ / ₈ " x 8"	3
30282	20" x 12 ³ / ₈ " x 12"	2
30283	20" x 12 ³ / ₈ " x 12"	2
30284	23 ⁷ / ₈ " x 8 ¹ / ₄ " x 7"	4
30286	23 ⁷ / ₈ " x 11" x 7"	4
30287	23 ⁷ / ₈ " x 11" x 10"	4
30288	23 ⁷ / ₈ " x 16 ¹ / ₂ " x 11"	4
30289	23 ⁷ / ₈ " x 18 ¹ / ₄ " x 12"	4
30290	29 ¹ / ₄ " x 18 ³ / ₈ " x 12"	4
30292	29 ¹ / ₈ " x 11" x 10"	4
30293	29 ¹ / ₈ " x 16 ¹ / ₂ " x 11"	4



30293

F.



13017

G.

G. Clear Stak-N-Store Bins

CAT. NO.	OUTSIDE DIM. (L X W X H)	QTY/PACK
13014	17 ¹ / ₂ " x 10 ⁵ / ₈ " x 12 ¹ / ₂ "	4
13017	15 ¹ / ₄ " x 19 ⁵ / ₈ " x 12 ¹ / ₁₆ "	3
13018	17 ¹ / ₂ " x 16 ¹ / ₂ " x 12 ¹ / ₂ "	2

SHIPPING INFORMATION:
1-2 Days, F.O.B. Warrenville, IL

Super-Size AkroBins

Heavy-duty bins securely stack atop each other, or sit on shelving. Available in 12 sizes and 4 colors: red, yellow, blue & clear.

CAT. NO.	OUTSIDE DIMENSIONS L X W X H	INSIDE DIMENSIONS L X W X H X D	MAX. CAP. PER BIN	STACKING CAP. /= QTY. STACKED	QTY./ PACK
30280	20" x 12 $\frac{3}{8}$ " x 6"	16 $\frac{7}{8}$ " x 10 $\frac{1}{16}$ " x 5 $\frac{3}{8}$ " x 15 $\frac{1}{2}$ "	100 lbs.	40 lbs./10	4
30281	20" x 12 $\frac{3}{8}$ " x 8"	16 $\frac{7}{8}$ " x 10 $\frac{1}{16}$ " x 7 $\frac{3}{8}$ " x 15 $\frac{1}{2}$ "	150 lbs.	50 lbs./7	3
30282	20" x 12 $\frac{3}{8}$ " x 12"	16 $\frac{7}{8}$ " x 10 $\frac{1}{16}$ " x 11 $\frac{3}{8}$ " x 15 $\frac{1}{2}$ "	200 lbs.	60 lbs./5	2
30283	20" x 18 $\frac{3}{8}$ " x 12"	16 $\frac{7}{8}$ " x 16 $\frac{7}{16}$ " x 11 $\frac{3}{8}$ " x 15 $\frac{1}{2}$ "	300 lbs.	150 lbs./5	1
30284	23 $\frac{3}{8}$ " x 8 $\frac{1}{4}$ " x 7"	20 $\frac{3}{8}$ " x 6 $\frac{3}{8}$ " x 6 $\frac{3}{8}$ " x 19 $\frac{3}{8}$ "	200 lbs.	150 lbs./5	4
30286	23 $\frac{3}{8}$ " x 11" x 7"	20 $\frac{3}{8}$ " x 9 $\frac{1}{8}$ " x 6 $\frac{3}{8}$ " x 19 $\frac{3}{16}$ "	200 lbs.	150 lbs./5	4
30287	23 $\frac{3}{8}$ " x 11" x 10"	20 $\frac{3}{4}$ " x 9" x 9 $\frac{3}{8}$ " x 19 $\frac{3}{16}$ "	300 lbs.	150 lbs./5	4
30288	23 $\frac{3}{8}$ " x 18 $\frac{1}{4}$ " x 12"	20 $\frac{3}{4}$ " x 16" x 11 $\frac{1}{8}$ " x 19 $\frac{3}{16}$ "	300 lbs.	150 lbs./5	1
30289	23 $\frac{3}{8}$ " x 18 $\frac{1}{4}$ " x 12"	20 $\frac{3}{8}$ " x 9 $\frac{3}{8}$ " x 6 $\frac{3}{8}$ " x 19 $\frac{1}{4}$ "	300 lbs.	150 lbs./5	1
30290	29 $\frac{1}{4}$ " x 18 $\frac{3}{8}$ " x 12"	26 $\frac{1}{8}$ " x 16 $\frac{7}{16}$ " x 11 $\frac{3}{8}$ " x 24 $\frac{3}{4}$ "	300 lbs.	150 lbs./5	1
30292	29 $\frac{3}{8}$ " x 11" x 10"	26 $\frac{3}{4}$ " x 9" x 9 $\frac{3}{8}$ " x 25 $\frac{3}{16}$ "	300 lbs.	150 lbs./5	4
30293	29 $\frac{3}{8}$ " x 16 $\frac{1}{2}$ " x 11"	26 $\frac{3}{4}$ " x 14 $\frac{3}{8}$ " x 10 $\frac{1}{8}$ " x 25 $\frac{3}{16}$ "	300 lbs.	150 lbs./5	1

One color per carton. Not recommended to hang on rack or panel systems.

Lengthwise and widthwise dividers available.



AKRO-MILS

Bins

Quickly organize work environments — separate and sort parts or products to increase efficiency, shorten assembly times, and maintain accurate inventories.

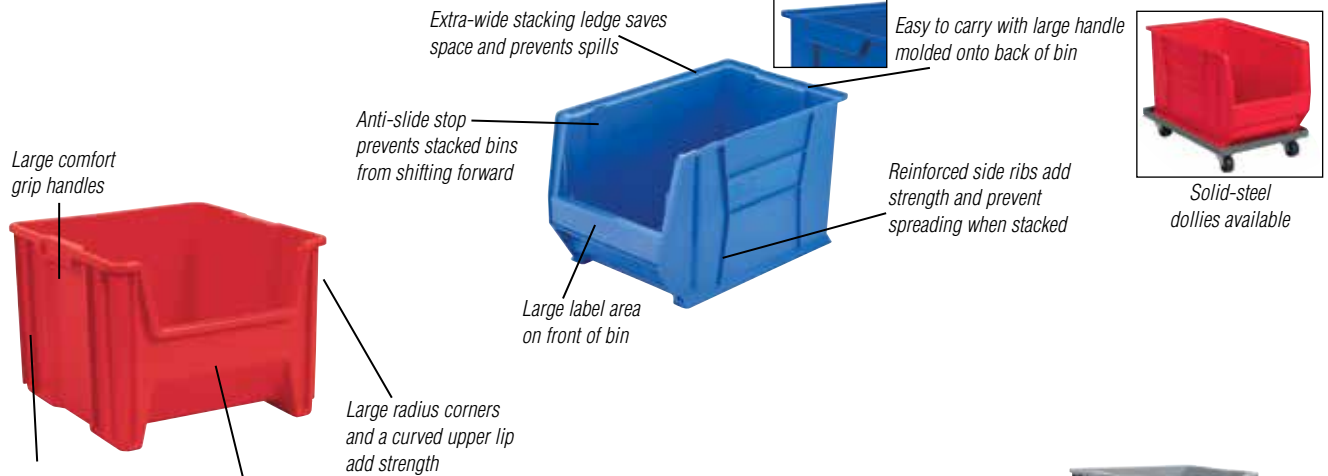

Stak-N-Store Bins

- Bins stack to form tall, stable storage arrangements on floors or standard industrial shelving
- 75 lb. weight capacity
- Colors: gray, red, blue

CAT. NO.*	OUTSIDE DIMENSIONS L X W X H	QTY./ PACK
13014	17 $\frac{1}{2}$ " x 10 $\frac{3}{8}$ " x 12 $\frac{1}{2}$ "	4
13017	15 $\frac{1}{4}$ " x 19 $\frac{3}{8}$ " x 12 $\frac{1}{16}$ "	3
13018	17 $\frac{1}{2}$ " x 16 $\frac{1}{2}$ " x 12 $\frac{1}{2}$ "	2

*13017 also available in white



Stack bins together to form a storage system

SHIPPING INFORMATION:
1-2 Days, F.O.B. Warrenville, IL



AKRO-MILS

Nest & Stack Totes

- Ribs under the lip will prevent jamming when nested.
- Textured bottoms provide a no-slip grip on conveyor belts.
- Smooth surfaces are easy to clean.
- Comfortable grip makes handling easy.
- Available in 9 sizes and 3 colors: red, blue and gray.
- Stack together for dense storage.
- Works with existing shelving.

Attached Lid Containers

- Textured bottoms provide a sure grip on conveyor belts.
- Strong molded-in handle grips are ergonomically designed for easy lifting and carrying.
- Padlock eye gives a security option.
- Reinforced hinge pins for years of smooth lid operation.
- High-density polyethylene.
- Designed to stack and nest for optimal space use.
- Color: gray or blue.



- FDA Approved
- High-Density Polyethylene



B. Label Holders

Clear plastic Label Holders attach easily, with or without the lid in place.

CAT. NO.	SIZE	QTY./PACK
35010	3¾" x 5"	6

A.

Specifications

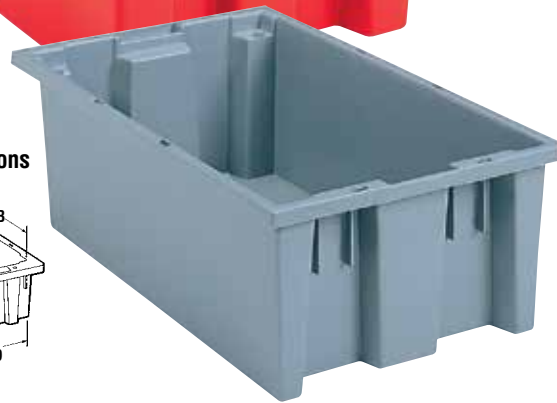
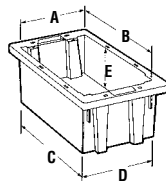

C. Lids

Lids snap tight to protect contents.

A. Nest & Stack Totes

CAT. NO.	OUTSIDE DIM. L X W X H	INSIDE DIM.			QTY./ PACK	CAP. CU. FT.	CAT. NO.	QTY./ PACK		
		A	B	C					D	E
35180	18" x 11" x 6"	10"	16"	15¼"	9⅞"	5⅞"	6	0.5	35181	6
35185	18" x 11" x 9"	10"	16"	15⅞"	9⅞"	8⅞"	6	0.8	35181	6
35190	19½" x 15½" x 10"	14½"	17"	16"	13¼"	9⅞"	6	1.2	35191	6
35195	19½" x 15½" x 13"	14½"	17"	15⅞"	13⅞"	12⅞"	6	1.7	35191	6
35200	19½" x 13½" x 8"	12⅞"	17⅞"	16⅞"	11½"	7⅞"	6	0.8	35201	6
35225	23½" x 19½" x 10"	18⅞"	20⅞"	19⅞"	16⅞"	9⅞"	3	2.0	35231	3
35230	23½" x 19½" x 13"	18⅞"	20⅞"	19½"	16⅞"	12⅞"	3	2.6	35231	3
35240	23½" x 15½" x 12"	14⅞"	20⅞"	19⅞"	13"	11⅞"	3	1.7	35241	3
35300	29½" x 19½" x 15"	18⅞"	26⅞"	25⅞"	16⅞"	14⅞"	3	3.7	35301	3

*Please specify color when ordering. Order in carton quantities.

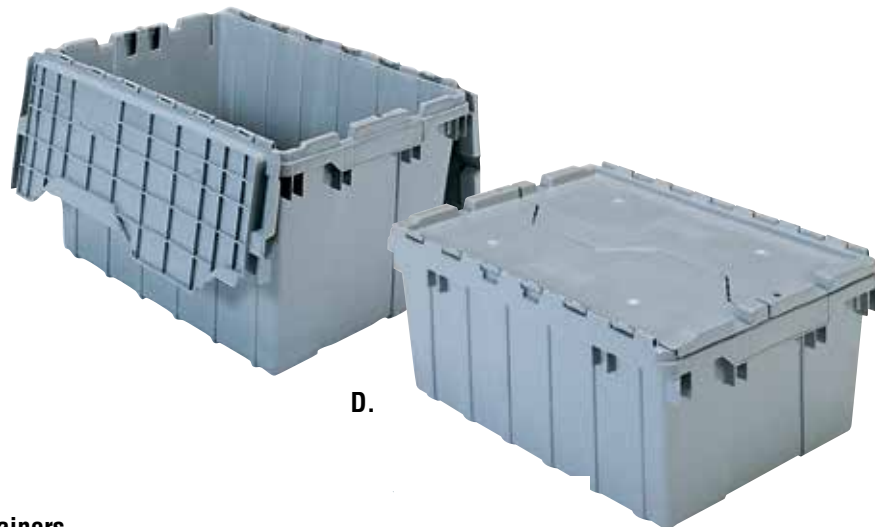

D.

D. Attached Lid Containers

CAT. NO.	OUTSIDE DIM. L X W X H	INSIDE DIM. TOP L X W X H	INSIDE DIM. BOTTOM L X W	CU. FT.	CAPACITY GAL.	COLOR	QTY./ PACK
39120	21½" x 15" x 12½"	19¼" x 14½" x 12"	18⅞" x 13¼"	1.62	12	blue/gray	6
39160	27" x 17" x 12½"	25" x 15½" x 11"	23½" x 14"	2.25	16.83	gray	1
39170	21½" x 15" x 17"	19¼" x 14½" x 16⅞"	18⅞" x 13¼"	2.28	17	blue/gray	3
39175	24" x 19½" x 12½"	22" x 18" x 11"	20⅞" x 16½"	2.30	17.20	gray	1
39280	28" x 21" x 15½"	29" x 19" x 14"	25" x 18"	3.82	28.57	gray	1

SHIPPING INFORMATION: 1-2 Days, F.O.B. WARRENVILLE, IL



Straight Wall Containers

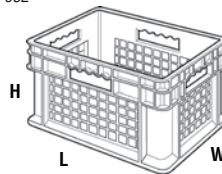

Straight Wall Containers

Three styles per size. Color: gray.

MESH SIDE AND BASE CAT. NO.	MESH SIDE WITH SOLID BASE CAT. NO.	SOLID SIDE AND BASE CAT. NO.	OUTSIDE DIMENSIONS L X W X H	INSIDE DIMENSIONS L X W X H	QTY./PACK
37208	37278	37288	15 3/4" x 11 3/4" x 8 1/4"	14 1/4" x 10 1/4" x 8"	12
37608	37678	37688	23 3/4" x 15 3/4" x 8 1/4"	22 1/4" x 14" x 8"	4
37612	37672	37682	23 3/4" x 15 3/4" x 12 1/4"	22 1/4" x 14" x 12"	3
37616	37676	37686	23 3/4" x 15 3/4" x 16 1/4"	22 1/4" x 14" x 16"	2

NOTE: Order in carton quantities.

SHIPPING INFORMATION:
1-2 Days, F.O.B. Wadsworth, OH



Storage-Go-Round for Steel 19-Series Cabinets

(Item # 98325)

Create a high-density storage system using the Storage-Go-Round kit. Mix and match (20) 19-Series steel frame cabinets in this compact unit. The rugged ball-transfer base allows for smooth rotation and easy access to parts. 1,000 lb. capacity.



Complete Unit = (1) 98325 + (20) 19-Series Cabinets

Stand Alone Steel Storage Cabinets; Compatible Accessories to Storage-Go-Round Unit (Item # 98325)



19228



19320



19416



19715



19909

Steel Storage Cabinets

Store, Consolidate and Organize Small Parts

Two cabinets fit side by side on a standard 36" side shelving. Drawers are removable and are rust, corrosion and dent proof. No sharp edges to damage parts. Unique rear stop tab on each drawer prevents spills. Additional dividers, labels and replacement drawers can be purchased separately. Color: gray.

SHIPPING INFORMATION:
1-2 Days, F.O.B. Warrenville, IL

CAT. NO.	DESCRIPTION	DRAWER DIMENSIONS H X W X D	NO. OF DRAWERS	QTY./PACK
19228	Storage Cabinet*	2 1/16" x 2 3/16" x 10 1/16"	28	1
19320	Storage Cabinet*	2 1/16" x 3 3/16" x 10 1/16"	20	1
19416	Storage Cabinet*	2 1/8" x 4" x 10 1/16"	16	1
19715	Storage Cabinet*	3 1/16" x 3 3/16" x 10 1/16"	15	1
19909	Storage Cabinet*	3 1/16" x 5 1/16" x 10 1/16"	9	1

* Available with a locking door when ordered in quantities of 50 or more.

Welded Steel Mobile Storage Bins

- Overall dimensions: 32" W x 45 1/2" H x 20" D
- 800 lbs. capacity per tier; 2400 lbs. overall capacity
- 4-swivel casters with hard tread phenolic wheels for ease of movement

MS2-1532-6PH



CAT. NO.	OPENINGS PER LEVEL	TOTAL OPENINGS	OPENING SIZE W X H X D	LBS.
MS1-1532-6PH	1	3	32" x 12 1/2" x 15"	210
MS2-1532-6PH	2	6	16" x 12 1/2" x 15"	217
MS3-1532-6PH	3	9	10 1/2" x 12 1/2" x 15"	235
MS4-1532-6PH	4	12	8" x 12 1/2" x 15"	252

WARNING: Cancer and reproductive harm - www.P65Warnings.ca.gov



Welded Steel Mobile Storage Bins

- **Heavy Duty:** All-welded 12-gauge steel construction with powder-coated finish for rugged durability
- **Open Hopper Front:** Each level has overall dimensions of 12 1/2" H x 15" D x 32" W
- **Welded Dividers:** Available with up to four permanent storage compartments per level

SHIPPING INFORMATION:
2 Weeks, F.O.B. University Park, IL

STORAGE



Heavy-Duty Modular Cabinets

The Rousseau cabinet comes in five different widths — each offered in different depths — for a total of 11 combinations, each available in six heights. Add to that the 10 drawer heights and you have an incredible choice of possibilities.

The Rousseau Advantages

- 400-lb. capacity per drawer; 100% extension; lifetime warranty on rolling mechanism

Locking & Security Mechanisms Available

- Drawer integrated lock-in mechanism; true one-drawer-at-a-time system; drawer and cabinet lock; drawer lock-out mechanism

Drawer Accessories Available

- Partitioning; plastic bins; foam for tools and protection, PVC drawer liner; groove trays; hanging file bars

The unique design of the R Drawer is a copyright of Rousseau Metal Inc.

A. Bench Height Cabinet — 32"H

- Includes a 2" recessed base
- Drawer sizes: two 4", one 6" and one 12"

CAT. NO.	W X D	DRAWERS	COMPARTMENTS	LBS.
R5ACD-3013	24" x 21"	4	37	218
R5ACD-3014	24" x 21"	4	—	200
R5ACG-3013	24" x 27"	4	58	261
R5ACG-3014	24" x 27"	4	—	235

A.



B. Counter Height Cabinet — 46"H

- Includes a 2" front access forklift base
- Drawer sizes: two 3", one 4", one 6", one 7", one 8" and one 9"

CAT. NO.	W X D	DRAWERS	COMPARTMENTS	LBS.
R5AEC-4409	36" x 18"	7	102	381
R5AEC-4410	36" x 18"	7	—	343
R5AEE-4409	36" x 24"	7	135	466
R5AEE-4410	36" x 24"	7	—	407

B.



C. Eye-Level Height Cabinet — 60"H

- Includes a 2" front access forklift base
- Drawer sizes: six 4", one 8", one 10" and one 12"

CAT. NO.	W X D	DRAWERS	COMPARTMENTS	LBS.
R5ADG-5821	30" x 27"	9	180	592
R5ADG-5822	30" x 27"	9	—	506

C.



D. Eye-Level Height Cabinet — 60"H

- Includes a 2" front access forklift base
- Drawer sizes: five 6" and three 8"

CAT. NO.	W X D	DRAWERS	COMPARTMENTS	LBS.
R5AHE-5815	48" x 24"	8	120	682
R5AHE-5816	48" x 24"	8	—	581
R5AHG-5815	48" x 27"	8	120	733
R5AHG-5816	48" x 27"	8	—	623

D.



SHIPPING INFORMATION: 2-3 Weeks, F.O.B. Williston, VT

Drawer Partition Kits

The chart below indicates the type of layout kits available in compartmented drawers. Contact your local Crown Lift Trucks representative today for pricing.

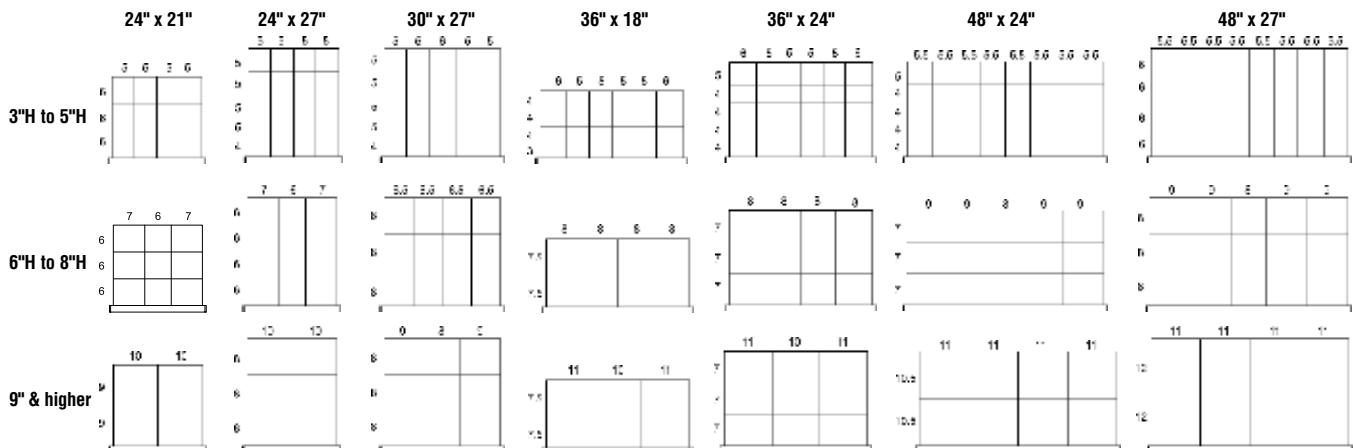

30-DRAWER ORGANIZERS



1. DURABLE CONSTRUCTION

Steel, all-welded construction provides years of reliable use.

2. LABEL IT - FIND IT

Large indexing area provides plenty of room to label contents.

3. REMOVABLE DRAWERS

Drawers can be removed and interchanged for convenience.

Safety stop prevents drawers from accidentally falling out of unit

4. OPTIONAL DIVIDERS

Sort contents of drawers with slide-in dividers.

Great for organizing small items and parts.

5. WINDOW FRAME CONSTRUCTION

Drawers slide in and out within individual steel compartments.

6. RAISED BASE

Base offers protection by keeping materials off of the floor.

7. COMBINE UNITS

30-drawer organizers and literature sorters can be bolted back-to-back, side-to-side or double stacked.

8. DURABLE, ATTRACTIVE FINISH

Powder-coated durable finish.



Optional drawer divider available in black only.

- **Perfect for small parts organization such as hardware, PPE and tools.**
- **Drawers feature integrated label holders and pulls.**

11.5" Deep								
W	X	D	X	H	CAT. NO	WEIGHT	DRAWER CAP. (LBS.)	
30	5/8"	X	11 5/8"	X	33"	2085	95	15
14.5" Deep								
30	5/8"	X	14 5/8"	X	33"	3085	112	15
Optional Drawer Dividers (Pack of 30)								
9	1/16"	X	N/A"	X	2 11/32"	30AD	6.7	N/A

Available colors:





CELL PHONE LOCKERS

Tennsco Cell Phone Lockers are great for electronic storage or for general storage of small items.

- Perfect Solution for factories and warehouses requiring employees to secure electronic devices during working hours.
- Ships fully assembled; simply unpack and put into use!
- Welded body construction provides a rigid structure.

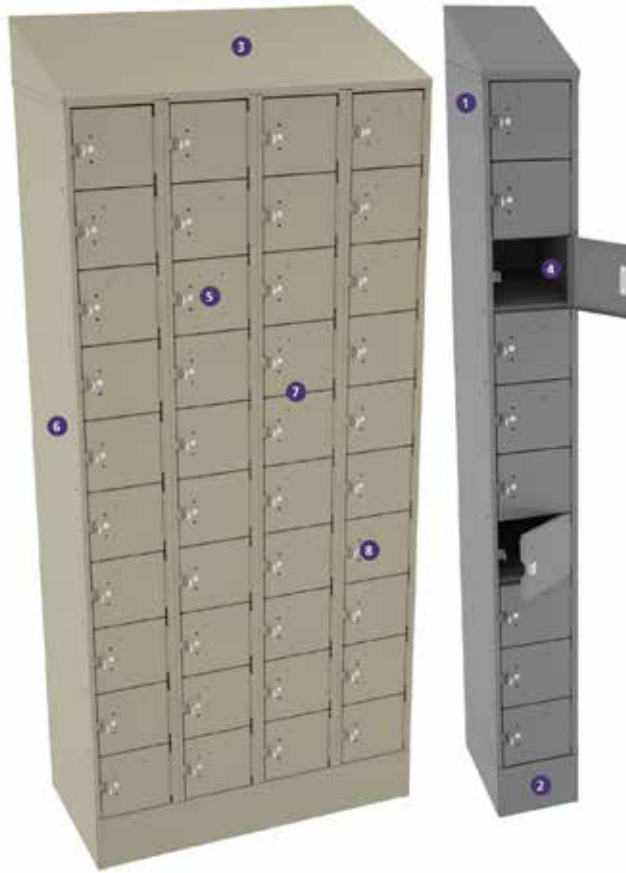

- FULLY-WELDED BODY**
Locker ships fully assembled.
- INTEGRAL BASE**
Allows for easy access to lower compartments.
- SLOPING TOP**
Sloping top prevents accumulation of clutter. Comes standard.
- SPACIOUS OPENINGS**
Plenty of room to store cell phones, iPads, tablets, etc.
10 door high: 7-1/2" x 6-1/4" clear opening; 10-1/4 diagonal clearance.
12 door high: 7-1/2" x 5-1/4" clear opening; 9-1/2 diagonal clearance.
- Door Pull Design**
Accepts standard padlocks with up to a 9/32" diameter shackle.
- SIZE OPTIONS**
Available with 10 or 12 doors per column and one or four columns wide.
- ACCEPTS NUMBER/NAME PLATES**
Doors accept Tennsco number/name plates.

Options

- LNP-3 (Black Number Plate)
- LNP-A (Aluminum Number Plate)
- LNP-5 (Custom Name Plate)

8. INSTALLED MASTER LOCKS AVAILABLE (upon request)

Must request locks at time of order.
Compatible master locks.

Options

- MAS-1710MK (Grooved Key)
- MAS-1670 (Dead Bolt)
- MAS-1654 (Spring Bolt)



CP12-091572-A
12-Door High,
1-Door Wide
Shown in
Champagne/Putty



CP10-091572-D
10-Door High,
4-Door Wide
Shown in
Medium Grey

Cell Phone Lockers								
W	X	D	X	H	CAT. NO	WEIGHT	# OPENINGS	
9	X	15	X	83	CP10-091572-A	107	10	
36	X	15	X	83	CP10-091572-D	246	40	
9	X	15	X	83	CP10-091572-A	112	12	
36	X	15	X	83	CP10-091572-D	264	48	

Number Plates						
W	X	D	X	H	CAT. NO	WEIGHT
2 7/16"	X	N/A	X	3/4"	LNP-A	0.1

Available colors:





High Capacity Storage Cabinets

Rugged, 12 gauge, all-welded cabinet is designed for long term use in the most demanding environments. Secure 3-point latching system with keyed handle secures the doors at the top, center and bottom. 14 gauge shelves are adjustable in 3½" increments. Doors swing open 180 degrees, allowing complete access to the interior. 1500 lb. shelf capacity. Durable powder coated gray finish. Overall height 78".



SSL2-A-2448
2 Adjustable Shelves



SSL2-A-2448

INTERIOR D X W	2 ADJ. SHELVES CAT. NO.	LBS.	3 ADJ. SHELVES CAT. NO.	LBS.	4 ADJ. SHELVES CAT. NO.	LBS.
24" x 48"	SSL2-A-2448	446	SSL3-A-2448	476	SSL4-A-2448	506
24" X 60"	SSL2-A-2460	527	SSL3-A-2460	564	SSL4-A-2460	601
30" X 48"	SSL2-A-3048	502	SSL3-A-3048	539	SSL4-A-3048	576
30" X 60"	SSL2-A-3060	591	SSL3-A-3060	637	SSL4-A-3060	683

WARNING: Cancer and reproductive harm - www.P65Warnings.ca.gov

Receiving Station

2000 lbs. capacity. All-welded, 12 gauge construction. Top surface measures 24" deep x 36" wide and is enclosed on three sides with flush front edge to provide an open writing surface. The height can be set from 39½" to 42½" above the floor. The 3-shelf version has 13" of clearance between the three shelves, and the 2-shelf station has 27" of clearance. Riser measures 10" deep and is 12" above the writing surface, allowing storage of most 3-ring binders. Floor glides adjust to almost any uneven floor surface.



RS3-2436-LL

OVERALL D X W	CAT. NO.	DESCRIPTION	LBS.
24" x 36"	RS-2436-LL	Without Center Shelf	159
24" x 36"	RS3-2436-LL	With Center Shelf	192

WARNING: Cancer and reproductive harm - www.P65Warnings.ca.gov

Receiving Station With Locking Doors

Two locking doors feature a 3-point latching system and keyed locking handle to keep your items secure.



RS-2D-2436-LL

OVERALL D X W	CAT. NO.	DESCRIPTION	LBS.
24" x 36"	RS-2D-2436-LL	Without Center Shelf	182
24" x 36"	RS3-2D-2436-LL	With Center Shelf	215

WARNING: Cancer and reproductive harm - www.P65Warnings.ca.gov

Heavy-Duty Welded Steel Closed Shelving

Heavy-duty reinforced 12 gauge steel shelves have 2000 lbs. capacity per shelf and are enclosed on three sides to help protect and store your items. Solid steel-sided shelving provides a clean and uniform look. 2" x 2" x 3/16" corner angles have footpads with anchor hole. 72" overall height with 3½" bottom shelf clearance. Three center shelves with 15" clearance between shelves. Built to last. Durable powder coated gray finish.



5SE-2448-72

SHELF D X W	CAT. NO.	LBS.
16" x 32"	5SE-1832-72	263
24" x 36"	5SE-2436-72	335
24" x 48"	5SE-2448-72	429
24" x 60"	5SE-2460-72	504

WARNING: Cancer and reproductive harm - www.P65Warnings.ca.gov

SHIPPING INFORMATION:
2 Weeks, F.O.B. University Park, IL

Deluxe Storage Cabinets

- Shelves adjust in increments of 2" and will hold up to 200 lbs. evenly distributed
- Knuckle hinges maintain door alignment
- 16-gauge door frame for extra strength
- Doors are reinforced for rigidity and quietness
- Brushed chrome handles on both doors for easy opening and closing
- Three-point locking for maximum security
- Raised base keeps contents from contacting moisture from the floor
- Ventilation louvers on back panel allow air to circulate through cabinet
- Two adjustable levelers compensate for uneven floor

Jumbo Cabinets

- Holds 1/3 more cubic feet than 36" wide cabinets
- Box-formed shelf design for maximum load capacity
- Shelves adjust in increments of 2" and will hold up to 400 lbs. evenly distributed
- Four leaf hinges maintain door alignment
- Doors are reinforced for rigidity and quietness
- Brushed chrome handles on both doors for easy opening and closing
- Three-point locking for maximum security
- Raised base keeps contents from contacting moisture from the floor
- Two adjustable levelers compensate for uneven floor

Standard Storage Cabinets

- Shelves adjust in 2" increments and will hold up to 200 lbs. evenly distributed
- Three leaf hinges maintain door alignment
- Doors are reinforced for rigidity and quietness
- Three-point locking security

All cabinets are available in black, light gray, medium gray, putty and sand.

A. 36" Wide Deluxe Counter High Cabinets

Includes two adjustable shelves.

CAT. NO.	W X D X H	LBS.
Shipped "Set-Up" (All-Welded)		
4218DLX	36" x 18" x 42"	90
4224DLX	36" x 24" x 42"	103
Shipped "Ready to Assemble"		
1842	36" x 18" x 42"	90
2442	36" x 24" x 42"	103



A.

B. 36" Wide Deluxe Storage Cabinets

Four adjustable shelves.

CAT. NO.	W X D X H	LBS.
Shipped "Set-Up" (All-Welded)		
7818	36" x 18" x 78"	152
7824	36" x 24" x 78"	176
Shipped "Ready to Assemble"		
1870	36" x 18" x 78"	154
2470	36" x 24" x 78"	183
Extra Shelves (for Models A & B)		
301	36" x 18"	8
302	36" x 24"	12



B.

C. 36" Wide Deluxe Combination Cabinets

Combines office supplies/package storage and wardrobe facilities in one cabinet. One full-width shelf at top. Four adjustable half-shelves.

CAT. NO.	W X D X H	LBS.
Shipped "Set-Up" (All-Welded)		
7814	36" x 18" x 78"	160
7820	36" x 24" x 78"	192
Shipped "Ready to Assemble"		
1872	36" x 18" x 78"	152
2472	36" x 24" x 78"	181



C.

D. 48" Wide Jumbo Storage Cabinets (not shown)

Four adjustable shelves.

CAT. NO.	W X D X H	LBS.
Shipped "Set-Up" (All-Welded)		
J1878SU	48" x 18" x 78"	200
J2478SU	48" x 24" x 78"	230
Shipped "Ready to Assemble"		
J1878A-N	48" x 18" x 78"	194
J2478A-N	48" x 24" x 78"	214
Extra Shelves		
306	48" x 18"	12
307	48" x 24"	16

E. 48" Wide Jumbo Combination Cabinets

Combines office supplies/package storage and wardrobe facilities in one cabinet. One full-width shelf at top. Four adjustable half-shelves.

CAT. NO.	W X D X H	LBS.
Shipped "Set-Up" (All-Welded)		
J1878SUC	48" x 18" x 78"	200
J2478SUC	48" x 24" x 78"	230
Shipped "Ready to Assemble"		
J1878C-N	48" x 18" x 78"	193
J2478C-N	48" x 24" x 78"	213
Extra Half Shelves		
JPS18	24" x 18"	4
JPS24	24" x 24"	5



E.

F. 36" Standard Storage Cabinets

CAT. NO.	W X D X H	LBS.
Shipped "Set-Up" (All-Welded)		
7218	36" x 18" x 72"	126
7224	36" x 24" x 72"	143



F.

SHIPPING INFORMATION: 5 Days, F.O.B. Dickson, TN



A.



B.



C.



D.

A. Single-Tier Lockers

With 6" legs; assembled.

CAT. NO.	W X D X H	# OPENINGS	LBS.
STS-121872-1	12" x 18" x 78"	1	78
STS-121872-3	36" x 18" x 78"	3	198
STS-151872-1	15" x 18" x 78"	1	87
STS-151872-3	45" x 18" x 78"	3	217

B. Double-Tier Lockers

With 6" legs; assembled.

CAT. NO.	W X D X H	# OPENINGS	LBS.
DTS-121836-1	12" x 18" x 78"	2	73
DTS-121836-3	36" x 18" x 78"	6	208
DTS-151836-1	15" x 18" x 78"	2	91
DTS-151836-3	45" x 18" x 78"	6	227

C. Five-Tier Lockers

With 6" legs; assembled.

CAT. NO.	W X D X H	# OPENINGS	LBS.
BS5-121512-1	12" x 15" x 66"	5	57
BS5-121512-3	36" x 15" x 66"	15	155
BS5-121812-1	12" x 18" x 66"	5	72
BS5-121812-3	36" x 18" x 66"	15	178

D. Six-Tier Lockers

With 6" legs; assembled.

CAT. NO.	W X D X H	# OPENINGS	LBS.
BS6-121512-1	12" x 15" x 78"	6	77
BS6-121512-3	36" x 15" x 78"	18	178
BS6-121812-1	12" x 18" x 78"	6	80
BS6-121812-3	36" x 18" x 78"	18	205

SHIPPING INFORMATION: 1-2 Weeks, F.O.B. Dickson, TN

Welded Wire Storage Lockers

Mesh: 10-ga. (.135). 2" x 2" (center to center) square welded wire design. **Doors:** Framed in 1 1/4" x 1 1/4" x 13-ga. angle and pre-hung at the factory. All doors supplied with door strikes, padlock lugs, and 2 1/2" x 2 1/2" spun-pin hinges welded into place. **Panels:** Framed with 1 1/4" x 1 1/4" x 13-ga. angle. **Backs (optional):** 16-ga. galvanized sheet metal. **Tops (optional):** Constructed of the same fabric as the standard locker. **Shelves/Bottoms (optional):** 16-ga. formed galvanized steel adds strength and versatility. **Hardware:** Standard grade 3/8"



plated nuts and bolts will be supplied for assembly, 3/8" mechanical anchors for wall and floor mount. **Finish:** All non-plated parts are powder-coated gray. Other colors are available for an upcharge. Product is finished for interior applications. Materials are shipped loose and subject to nicks and scrapes while in transit. Touch-up paint is provided. All lockers are shipped knocked down, ready for assembly.

SHIPPING INFORMATION: 2-3 Weeks, F.O.B. Louisville, KY



Assembled Lockers

Heavy-gauge steel doors on single and double-tier lockers are designed with door stiffeners to reduce noise and operate smoothly. Black door handles on single and double-tier lockers are recessed to give a clean look as well as to discourage vandalism. All lockers are standard with a padlock hasp. All doors have louvers for ventilation. Lockers are available in one-wide and three-wide units. Overall height includes the 6" legs. Assembled lockers have a welded body with a riveted door assembly. Plastic number plates included (specify numbers 1-1999). Available in durable powder-coated finishes of medium gray and sand.

Single-Tier Lockers

Each 72"H locker has a shelf, three garment hooks and a removable coat rod. Locking system secures the door at three points.

Double-Tier Lockers

Each 36"H locker has three garment hooks and a two-point locking system.

Five & Six-Tier Lockers

Each locker measures 12"W x 12"H (choose 15" or 18" depth).

WireCrafters

Welded Wire Storage Lockers

Service lockers manufactured by WireCrafters are made of their RapidWire Locker design. 10-gauge welded wire is in a 2" x 2" square pattern. The sheets of mesh are then welded into a 1 1/4" x 1 1/4" x 13-gauge rolled formed angle. These welded wire panels are then fabricated into the service lockers which measure 2'0" x 2'0" x 1'9" high. Four tier lockers are combined to reach a height of 7'0". They are open in the back and have a lockable front (padlock not included)

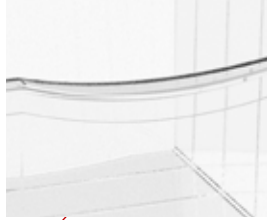

Optional Clear Bin

tennsco
Storage Made Easy

CUBBIES

Tennsco Cubbies are ideal for open organization of your items.

- Open design provides easy access to items being stored.
- Shelves are adjustable on 1" centers and can be removed or added.
- Each cubby ships with 3 coat hooks.
- Optional clear bins add more storage options to Tennsco Cubbies, providing greater organization space for smaller items.
- Welded body construction provides a rigid structure.



CC-30 in Light Grey

CC-40 in Medium Grey

CC-52 in Sand

CC-66 in Estey Blue

CC-78 in Crimson

CUBBIES

W	X	D	X	H	CAT. NO	WEIGHT	# OPENINGS
34 1/2"	X	13 1/2"	X	30"	CC-30	56	6
34 1/2"	X	13 1/2"	X	40"	CC-40	76	9
34 1/2"	X	13 1/2"	X	52"	CC-52	97	12
34 1/2"	X	13 1/2"	X	66"	CC-66	120	15
34 1/2"	X	13 1/2"	X	78"	CC-78	140	18

Clear Bins for Cubbies

W	X	D	X	H	CAT. NO	WEIGHT
10 3/32"	X	13 3/4"	X	2 1/4"	CCB-2	3.8
10 3/32"	X	13 3/4"	X	4 1/4"	CCB-4	4.2
10 3/32"	X	13 3/4"	X	6 1/4"	CCB-6	4.5
10 3/32"	X	13 3/4"	X	8 1/4"	CCB-8	4.8



CCB-2



CCB-4



CCB-6



CCB-8

Extra Shelf

W	X	D	X	H	CAT. NO	WEIGHT
10	X	12 3/4"	X	3/4"	ECS-1	1.6

Available colors:



ECS-1 Extra Shelf and (4) Clips





Drum Handling Equipment

Harper Trucks manufactures a complete line of all-welded tubular steel, aluminum and nylon hand trucks. Noted for quality, Harper hand trucks have become an industry accepted standard. Raw materials, design, manufacturing and finishing methods are carefully combined to provide units with maximum strength and service. All Harper hand trucks are completely manufactured and finished in Wichita, Kansas in the United States. The color of the hand trucks is dark green.

A. Model 7889

Design enables one person to quickly, easily and safely move drums weighing up to 1200 lbs. Replaceable chime hook and lifting toes ensure a long product life. Lifting toes create a cradle for easy break-over. Spring loaded swing axle keeps truck in upright position when not in use. Handles drums from 21" to 43" high.

CAT. NO.	WHEEL DESCRIPTION	CAP. (LBS.)	H X W	LBS.
7889	10" x 2" mold-on rubber tire	1200	62" x 23"	81

B. Model 7559

Adjustable sliding chime hook for steel or fiber drums. Foot rest helps position truck under drum, eases break-over and serves as a safety device. Kickstand holds truck upright when not in use. Handles drums from 24" to 48" high.

CAT. NO.	WHEEL DESCRIPTION	CAP. (LBS.)	H X W	LBS.
7559	10" x 2" mold-on rubber tire	1200	60" x 25"	48



SHIPPING INFORMATION: 1 Week, F.O.B. Wichita, KS



SHIPPING INFORMATION:
Stock to 10 Business Days, F.O.B. Lake City, MN
All Products Made in the U.S.A.



Drum Hand Trucks

Product No.	Material	Wheels
F82175A2	Aluminum	Pneumatic
F82645A4		Mold-On Rubber
F82375A0	Steel	Pneumatic
F82845A2		Mold-On Rubber

- 4-Wheel for improved control and handling.
- Compatible with steel, plastic, and fiber drums.
- Ergonomic design with rubber grip twin handles and full loop handle.
- Standard universal chime hook is spring-loaded with hands-free connection.
- 1,000 lb. capacity.

Powered Drum Hand Trucks

Product No.	Material	Wheels
F89484	Steel	Pneumatic
F89503		Solid Rubber

- Power drive improves safety when moving heavy loads.
- Compatible with steel, plastic, and fiber drums.
- Variable speed control and hand brake.
- Built-in 18AH rechargeable battery with monitor display.
- 800 lb. capacity.

A. Models 7659 and 76A59

A uniquely designed adjustable and replaceable universal chime hook fitting a large variety of plastic, steel and fiber drums. Foot rest helps position truck under drum, eases break-over and serves as a safety device. Kickstand holds truck upright when not in use. 76A handles drums from 26" to 48" high. 76 handles drums from 24" to 48" high.

CAT. NO.	WHEEL DESCRIPTION	CAP. (LBS.)	H X W	LBS.
7659	10" x 2" mold-on rubber tire	1200	60" x 25"	51
76A59	10" x 2" mold-on rubber tire	1200	60" x 25"	52



Model 76A59

B. Model 52DA60

Designed for the dual purpose of moving conventional boxed items as well as 30 and 55 gallon drums. Design of the chime hook allows the user to rotate the hook out of the way for hand truck applications. ¼" high strength steel base plate with beveled edge. 10" solid rubber wheels.

CAT. NO.	WHEEL DESCRIPTION	CAP. (LBS.)	H X W	LBS.
52DA60	10" x 2½" solid rubber tire	600	50" x 20"	31



C. Model 8818-41

Constructed of 1" O.D. x 14 gauge steel tubing welded for strength. Bung drain is 21" off floor in horizontal position. "Non-skid" features on front rockers to prevent frame from sliding when drum is tipped. For use with 30 and 55 gallon drums. Comes with two break-over retractable handles. 5" rubber wheels and 3" rubber casters.

CAT. NO.	WHEEL DESCRIPTION	CAP. (LBS.)	W X L	LBS.
8818-41	5" rubber wheels/3" casters	700	23½ x 36"	32



**Drum
Handling
Equipment**

Harper Trucks manufactures a complete line of all-welded tubular steel, aluminum and nylon hand trucks. Noted for quality, Harper hand trucks have become an industry accepted standard. Raw materials, design, manufacturing and finishing methods are carefully combined to provide units with maximum strength and service. All Harper hand trucks are completely manufactured and finished in Wichita, Kansas in the United States. The color of the hand trucks is dark green.

**SHIPPING INFORMATION:
1 Week, F.O.B. Wichita, KS**



Drum Handling Equipment

Morse Drum Handling Equipment is warranted against defects in workmanship or materials under normal use for a period of 2 years from date of purchase when used within the capacities specified. Motors and other purchased parts carry the warranty of their manufacturers.

Portable Drum Rollers

Morse Drum Handling Equipment is warranted against defects in workmanship or materials under normal use for a period of 2 years from date of purchase when used within the capacities specified. Motors and other purchased parts carry the warranty of their manufacturers.

Stationary Drum Rollers

Mixing contents inside a sealed drum eliminates the risks of spills and splashing of dangerous contents on workers during transfer, and greatly reduces clean-up, and the risk of contamination. It also eliminates use of special mixing vessels.

SHIPPING INFORMATION:
F.O.B. East Syracuse, NY

OSHA requires an enclosure with interlock for all drum rollers

A. Mobile Drum Dispenser

Can handle the full weight of a 55 gallon drum, yet be locked in horizontal position for faucet drain. Can be rotated 360°, tipped, or held manually at any angle. Move and steer on two 8" polyolefin roller bearing wheels with 4" swivel caster. Shipped partly disassembled.

CAT. NO.	DRUM TYPE	LBS.
80A	Steel	95
80APS	Plastic/Steel	97

WARNING: Cancer and reproductive harm - www.P65Warnings.ca.gov



A.

B. Dual Fork Lift Drum Mount

Two 55 gallon drums can now be easily removed from back of pallet in a tightly packed row. Fork reach mount and two carriage mounts w/heads (as shown on forks) are secured by chain. Shipped set-up.

CAT. NO.	DRUM CAPACITY	LBS.
288-2	Two (Shown)	376
288-1	One (Not Shown)	267

WARNING: Cancer and reproductive harm - www.P65Warnings.ca.gov



B.

C. Heavy Duty Forklift Drum Handler

Convert your fork truck into a drum handler. Easily raise, tilt and drain drums. 20' pull-chain loop allows control from driver's seat. Simple to mount. No tools, power connections or truck modifications. 60:1 gear ratio. Handles 55 gallon steel drum (22" to 23.5" dia.). Shipped set-up.

CAT. NO.	LBS.
285A-HD	171

OPTIONS:
4560-P; 4556-P

WARNING: Cancer and reproductive harm - www.P65Warnings.ca.gov



4560-P - forklift accessory with top rim clamp option for rimmed 55-gallon plastic drum



4556-P - forklift accessory with bracket assembly option needed for rimless plastic drum; also recommended to more securely handle a fiber drum

D. 55-Gallon Portable Drum Rollers

Roll a closed drum to mix and blend the contents. Compact industrial roller is 21" W x 35" L. Tipping lever with hook engages drum top rim to load drum onto the drum roller. Roll various size drums - adjust for mixing 55-gallon drums or 30-gallon drums. Use as a drain stand to dispense from drum.

CAT. NO.	LIQUID LOAD CAP. (LBS.)
201/20-1	500

OPTIONS: POLY-201 to roll plastic drum



D.



Place your drum onto the base plate of the 55-gallon drum mixer with a drum truck or a hook drum lifter.

WARNING: Cancer and reproductive harm - www.P65Warnings.ca.gov



Improved Top Rim Hook to help pull the drum over to rolling position.



The new kick stand design is easier to deploy and better supports the drum roller in upright position.

E. Stationary Drum Rollers

Rotating drums to mix or blend material inside a closed drum saves time, labor and money. Rotate a drum to mix the contents, and ensure homogeneity with less hazards. Remix settled or stratified ingredients. Raise and redistribute solids that have settled during shipping and storage. Drum rolls on 4 drive and 4 idler wheels. Roll Drums with: 6" to 28" diameter, up to 40" tall.

CAT. NO.	DRUM RPM (22.5" DIA.)
2-5154-3	20

WARNING: Cancer and reproductive harm - www.P65Warnings.ca.gov



Model 2-5154-3 Double Drum Roller rolls one or two 55-gallon steel drums.



E.

Load a Stationary Drum Roller using your hoist or crane.

A. Pail Tipper

- Overall dimensions: 14.5" W x 30" H x 14.5" D
- Boxed dimensions: 16.5" W x 22" D x 3" H

CAT. NO.	MODEL	CAP. (LBS.)	LBS.
273108	PTR	70	10

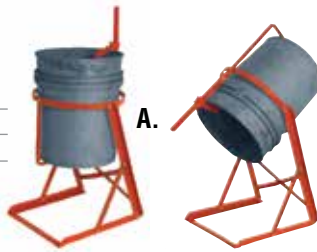

B. Steel Drum Dolly

- Drum size: 55 gallons
- I.D.: 24"
- Assembled overall dimensions: 28.5" W x 6" H x 28.5" D
- Caster rig: Zinc plate, 4 swivel
- Models available for 30, 55 and 85 gallon drums

CAT. NO.	MODEL	CAP. (LBS.)	LBS.
240030	D5-SI	1000	24.5



B.



C. Drum Racks

- Four-side fork truck entry
- Can be safely stacked 4 high
- Assembled overall dimensions:
2 Drum: 45.5" W x 12.5" H x 30" D
3 Drum: 71.5" W x 12.5" H x 30" D

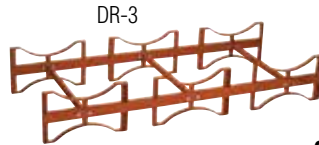

DR-3

C.



DR-2

CAT. NO.	MODEL	DRUMS	CAP. (LBS.)	LBS.
240026	DR-2	2	1600	49.0
240027	DR-3	3	2400	64.5

D. Drum Funnel with Lockable Cover

- 9.625" opening

CAT. NO.	MODEL	DESCRIPTION	CAP.	LBS.
272140	DF	Drum Funnel	4 quarts	1.1



D.

E. Gator Grip Drum Grab

- **EGG-1 & EGG-2:** Fork truck fork attachment; picks up drums automatically — driver never leaves seat while lifting or releasing drums; handles steel, fiber and poly drums
- **GG-F1 & GG-F2:** Fork truck attachment; heavy-duty carriage design

CAT. NO.	MODEL	SIZE W X H X D	CAP./GRIP (LBS.)	FORK POCKET		LBS.
				I.D.		
240091	EGG-1	28" x 34" x 34"	1000	5½" x 2"		125.5
240092	EGG-2	33¼" x 34" x 34"	1000	7" x 2¼"		208.0
240096	GG-F1	32" x 37" x 28"	1600	7" x 2¼"		244.0
240097	GG-F2	32" x 37" x 28"	1600	7" x 2¼"		340.0



E.



EGG-1



EGG-2



GG-F1



GG-F2

F. Ergonomic Drum Handler

- 2 wheels and 2 swivel casters, 5" x 2" phenolic, and floor lock
- Handles most 30, 55 or 85 gallon drums - steel, fiber and poly

CAT. NO.	MODEL	DESCRIPTION	RISE/STROKE	LEGS		LBS.
				RETRACTED CAP. (LBS.)	EXTENDED CAP. (LBS.)	
240150	DM-1100	Standard	1"	650	1100	355.5



F.

DM-1100 - 240150
STANDARD LIFT

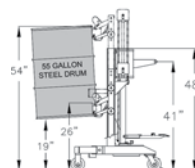

Pail Tipper

- Adjustable chime hook
- Ships knocked down; easy assembly

Steel Drum Dolly

- Wesco's Stability Advantage: By design, Wesco casters are mounted past the dolly and drum rim. The casters are mounted further apart than standard designs (which have casters completely underneath the drum and closer together). The further the casters are apart, the greater the stability.
- All-welded steel frame construction with reinforced outriggers
- Four bolt-on 3" swivel sintered iron casters

Drum Racks

- Two and three 55-gallon steel drum models
- Welded and bolted construction
- Quick and easy to assemble
- Standard models ship knocked down and boxed - via UPS

Drum Funnel with Lockable Cover

- Red polyethylene 4-quart funnel with 2" NPS fitting to screw into bung opening
- Equipped with black polyethylene lockable cover

Gator Grip Drum Grab

- Patented Auto Grip Lock automatically locks the jaws closed, even over rough terrain
- Single and dual grips available
- Made in USA

Ergonomic Drum Handler

- Ergonomic solution for lifting, transporting and placing drums on spill or standard pallets
- Spring-loaded clamp holds any ¾" or higher drum rim
- Operator does not need to touch drums to operate
- Exclusive Auto Grip Lock will not drop a drum
- Works with most drums with locking rings

SHIPPING INFORMATION:

1-2 WEEKS, F.O.B. Montgomeryville, PA

SHIPPING INFORMATION:
Stock to 10 Business Days, F.O.B. Lake City, MN
All Products Made in the U.S.A. 



Drum Lifts and Transporters

Product No.	Connection Type	Drum Capability		
		Type	Gallons	Diameter
F89265	Beak	Universal	30/55/85	-
F89264	Strap		30/55	14 - 24"
F89263	Cylinder	Cylinder	-	9 - 18"

- Beak: spring-loaded, hands-free chime hook for drums.
- Strap: dual ratchet straps for securing drums.
- Cylinder: expanded cradle with dual ratchet straps for cylinders and other tall containers.
- 800 lb. capacity.



Drum Lifts and Rotators

Product No.		Connection Type	Style
Straddle	Counterweighted		
F88564B8	F88581B7	Strap	Manual
F88566C6	F88570C0		Semi-Powered
F89837A1	F89831A4		Fully Powered
-		Grip	Manual
F88586C2	F88588C0		Semi-Powered
F80143A6	F80145A8		Fully Powered

- Manual: manual lifting, rotating, & drive.
- Semi-Powered: powered lifting & rotating; manual drive.
- Fully Powered: powered lifting, rotating, & drive.
- Strap: dual ratchet straps for securing drums.
- Grip: hands-free powered jaws connection.
- Straddle: extended legs go under pallets or shelving.
- Counterweighted: ability to butt directly up to platforms.
- 800+ lb. capacity.



Mechanical Forklift Attachments

Product No.	Drum Capability			Style
	Type	Gallons	Diameter	
F85370A0	Universal	30/55/85	-	Strap
F80147A7			14 - 24"	Beak
F87398A2	Steel	55	24"	Economy
F89743			30/55	18" or 24"
F86145B0	Plastic	30/55/85	18 - 28"	Deluxe
F86165A5				

- Strap: dual ratchet straps for securing drums.
- Beak: spring-loaded, hands-free chime hook for drums.
- Economy: knuckle-gripping jaws secures steel drum using natural pressure when lifting.
- Industrial: cam-actuated jaws secure steel drums automatically when lifting.
- Deluxe: secure grip, padded cam-actuated jaws secure steel/plastic drums automatically when lifting.
- Up to 1,500 lb. capacity.



Powered Drum Forklift Attachments

Product No.	Function	Power Source	Drum Capability	
			Type	Diameter
F89704	Clamp	Forklift	Universal	18 - 28"
F89705		Battery		
F89700	Clamp & Tilt	Forklift		
F89701		Battery		
F89702	Clamp & Rotate	Forklift		
F89703		Battery		
F89815A5	Clamp, Tilt, & Rotate	Battery		

- Clamp: secure drum with adjustable pressure gauge.
- Tilt: 120° forward tilt.
- Rotate: 360° rotation continuously in both directions.
- Forklift Powered: quick-connect auxiliary connection, use forklift controls.
- Battery Powered: corded pendant remote (wireless remotes sold separately).
- 2,000 lb. capacity.



Gas Cylinder Storage Cabinets

Product No.	Cylinder Size (lbs.)	Storage Type	Cylinder Capacity	Shelf/Rack Quantity
F89047	20/33/44	Shelf	8	2 Shelves
F89046		Horizontal	8	4 Racks
F89042			16	4 Racks
F89045	up to 200	Vertical	10	-
F89044			20	-
F89043	20/33/44, and up to 200	Horizontal & Vertical	18 (8/10)	4 Racks

- Fully welded 14 gauge steel construction.
- Heavy duty steel mesh offers ventilation and visibility.
- Steel legs feature predrilled holes for anchoring to the floor.
- Secure pin closure with padlockable hasp.
- Robust pin hinges eliminate possible door sagging.

Series 140

CAT. NO.	WHEEL DIAMETER AND TYPE	MAX. DIA. OXYGEN CYLINDER	MAX. DIA. ACETYLENE CYLINDER	BRACKET CHAIN HEIGHT	BASE PLATE DIMENSION	HEIGHT	WIDTH	LBS.
140-71	6" x 1.5" Semi-Pneu., BB	7"	8"	15"	7" x 15"	39"	19"	17.5
141-70	8" x 1.75" Semi-Pneu., Plain	7.5"	9"	23"	8" x 17"	46"	22"	24.0
142-86	10" x 2" Solid Rubber, BB	9.25"	10.5"	23"	9" x 20"	46"	28"	33.5
142-K19	10" x 3.5" Pneu., BB	9.25"	10.5"	23"	9" x 20"	46"	30"	30.5

140-71



Series 140

Deluxe models have refinements and features such as dual handle bars and hand grips for better control and stability when moving the loaded unit. All models come equipped with a tool box and have a cylinder hold chain, hose hook and welding rod holder tubes. Designed for small, medium and large cylinders. 140 and 141 models are available with 6", 7" or 8" wheels. 142 available with 10" wheels only.

Series 150

CAT. NO.	WHEEL DIAMETER AND TYPE	MAX. DIA. OXYGEN CYLINDER	MAX. DIA. ACETYLENE CYLINDER	BRACKET CHAIN HEIGHT	BASE PLATE DIMENSION	HEIGHT	WIDTH	LBS.
150-15	10" x 1.75" Semi-Pneu., Plain	7.5"	9.25"	24"	9" x 18"	39"	23"	32.25
150-27	14" x 1.75" Semi-Pneu., BB	7.5"	9.25"	24"	9" x 18"	39"	23"	33.0
150-25	12" x 1.75" Semi-Pneu., Plain	7.5"	9.25"	24"	9" x 18"	39"	23"	40.75
150-31	18" x 2" Steel, BB	7.5"	9.25"	24"	9" x 18"	39"	23"	40.0

150-15



Series 150

Continuous handle model supplies a wide range of wheel sizes. Cylinder hold chain and large tool box are standard equipment. Designed to handle a medium oxygen and small acetylene cylinder. Available with optional "Belly Band" - designate "B" in part number (Example 150B-15).

Series 700

CAT. NO.	WHEEL DIAMETER AND TYPE	CYLINDER SIZE	BRACKET CHAIN HEIGHT	BASE PLATE DIMENSION	HEIGHT	WIDTH	LBS.
701-86	10" x 2" Solid Rubber, BB	Designed to handle 9.25" cylinder	27"	7" x 14"	48"	21"	32.0
701SC-16	10" x 3.5" Pneu., BB	Designed to handle 9.25" cylinder	27"	7" x 14"	48"	21"	39.5
701BC86-40	10" x 2" Solid Rubber, BB	Designed to handle 9.25" cylinder	27"	7" x 14"	48"	21"	41.0
	3" x 1.25" Rubber Caster	Retractable 4th wheel					
740-27	14" x 1.75" Semi-Pneu., BB	Designed to handle 9.25" cylinder	27"	7" x 14"	48"	21"	41.0
742-16	10" x 3.5" Pneu., BB	Designed to handle two 9.25" cylinders	19" x 34"	9" x 18"	50"	23"	49.5
764-39	10" x 2.5" Solid Rubber, BB	Designed to handle two 9.25" cylinders	19" x 35"	9" x 18"	48"	20"	72.0
	5" x 1.25 Rubber Caster	Stationary 4th wheel					
786-40	10" x 2" Solid Rubber, BB	Designed to handle two 9.25" cylinders	19" x 34"	9" x 18"	50"	21"	51.0
	3" x 1.25 Rubber Caster	Retractable 4th wheel					

701-86



Series 700

Provides a wide range of utility for handling oxygen, acetylene, nitrogen, helium, argon and other gas cylinders. Base plates are designed for hauling boxes when needed. 701SC is equipped with stair crawlers for delivering cylinders up and down stairs. 786-40 & 701BC86-40 have retractable rear casters that lock into place for additional load handling safety and retracts into frame when not needed. 764-39 has rugged stationary rear assembly with heavy duty casters. Handles medium to large cylinders.

SHIPPING INFORMATION: 10 Days, F.O.B. Wichita, KS

JUSTRITE® Safety Cabinets

Industry-leading Justrite Safety Cabinets provide the best possible flammable liquid storage protection. Justrite's Sure-Grip® EX safety cabinets offer exclusive features to make your workplace EXtra safe, EXtra secure. Distinguishable differences including the U•Loc™ padlockable handle, Haz-Alert™ reflective warning labels, sturdy SpillsSlope™ shelves, 3-point stainless steel bullet self-latching system and welded construction help reduce fire risks while offering added convenience and safety. High performance, long-life design is backed by an industry first 10-year warranty.



894520



899000

Sure-Grip® EX Safety Cabinets - All Purpose, Yellow

Exclusive SpillsSlope™ galvanized steel shelves safely direct incidental spills to back and bottom of leaktight, 2" (51mm) bottom sump. Adjustable on 3" (76mm) centers for versatile storage, they meet ANSI standards with a 350 lbs. (159kgs) safe allowable load. Other extras include dual vents with flame arresters, four adjustable leveling feet, and a grounding connector. Fully painted inside and out with a durable lead-free epoxy/polyester powder paint for chemical resistance. All models are fully compliant to OSHA and NFPA and all are FM Approved. Self-close models also meet the International Fire Code and NFPA 1, Fire Code™. They shut and latch automatically when fusible links melt at 165°F (74°C) under fire conditions.

CAT. NO.	CAPACITY (GAL.)	NO. OF DOORS	DOOR TYPE	H X W X D	NO. OF SHELVES	LBS.	NET EA.	SHIPPING INFORMATION F.O.B. MATTOON, IL
893000	30	2	Manual	44" x 43" x 18"	1	221	\$701.60	7-10 days
893020	30	2	Self-close	44" x 43" x 18"	1	223	\$785.04	7-10 days
893300	30	2	Manual	35" x 36" x 24"	1	204	\$815.51	14 days
893080	30	1	Sliding, self-close	44" x 43" x 18"	1	246	\$1167.84	14 days
894500*	45	2	Manual	65" x 43" x 18"	2	299	\$869.03	7-10 days
894520*	45	2	Self-close	65" x 43" x 18"	2	301	\$954.76	7-10 days
894580	45	1	Sliding, self-close	65" x 43" x 18"	2	301	\$1342.66	10-14 days
896000*	60	2	Manual	65" x 34" x 34"	2	366	\$1046.50	7-10 days
896020*	60	2	Self-close	65" x 34" x 34"	2	368	\$1137.57	7-10 days
896080	60	1	Sliding, self-close	65" x 34" x 34"	2	374	\$1695.93	10-14 days
899000*	90	2	Manual	65" x 43" x 34"	2	421	\$1315.81	7-10 days
899020*	90	2	Self-close	65" x 43" x 34"	2	423	\$1498.50	7-10 days
899080*	90	1	Sliding, self-close	65" x 43" x 34"	2	480	\$2022.50	15-20 days

*Codes state that not more than 60 gallons may be Class I and Class II liquids.

⚠️ **WARNING:** Cancer and reproductive harm - www.P65Warnings.ca.gov

Sure-Grip® EX Piggyback Safety Cabinets

Low-height design allows you to store flammables on bench tops or on top of 30- or 45-gallon (114- and 170-L) cabinets

- Expand storage and safety segregate liquids
- Complies with OSHA and NFPA, FM-approved
- All welded, double-walled 18-gauge (1-mm) steel with 1-1/2-in (38-mm) of insulating air space
- Failsafe, 3-point stainless steel bullet latching system
- Leakproof 2-in (51-mm) sump captures spills
- U-Loc™ handle with two keys—accepts optional padloc
- Trilingual warning with Haz-Alert™ reflective labels
- Includes dual vents with flame arresters, adjustable leveling feet, grounding connector
- Self-closing models equipped with fusible link holds doors open during use and melts at 165 F (74 C) to automatically close under fire conditions
- Wall mount with optional wall hanger assembly, no. 25950



891300



891700

Capacity Gal/L	Number of and Style	Exterior H x W x D	Shelves	Approv/Lstg Regulation	Yellow Model	Red Model	Gray Model	White Model	CA Prop 65
12/45	2 door, manual	18 x 43 x 18 in 457 x 1092 x 457 mm	0	FM, N, O, A	891300	891301	891303	891305	
	2 door, self-close			FM, N, O, A, I	891320	891321	891323	891325	⚠️
17/64	2 door, manual	24 x 43 x 18 in 610 x 1092 x 457 mm	1	FM, N, O, A	891700	891701	891703	891705	
	2 door, self-close			FM, N, O, A, I	891720	891721	891723	891725	⚠️

⚠️ **WARNING:** Cancer and reproductive harm - www.P65Warnings.ca.gov



Cylinder Storage Cabinets

Store and protect your cylinders in a tamper-proof cabinet. Rectangular 2" x 1" 10 gauge mesh welded to 1 1/4" x 1 1/4" x 1/8" steel angle and channel frames. Heavy-duty hinges and padlock lugs. Galvanized steel roof. Meets OSHA and NFPA requirements. Painted safety yellow. Shipped knocked down.

All units have a safety retaining chain and trip rope assembly.

SHIPPING INFORMATION:

1-2 Weeks, F.O.B. Litchfield, MI



Cylinder/Gas Trucks

Model 701-86: Designed to handle a single 9 1/4" cylinder. Provides a wide range of utility for handling oxygen, acetylene, nitrogen, helium, argon and other gas cylinders.

Model 142-K19: Maximum diameter oxygen cylinder 9 1/4"; maximum diameter acetylene cylinder 10 1/2".

Color of trucks is dark green.

A. Vertical Storage Cabinets

Includes safety chain for securing cylinders.

CAT. NO.	DOORS	CYL.*	L X W X H	LBS.
116514	1	9	30" x 41" x 72"	285
116524	2	18	60" x 41" x 72"	463

*9" diameter cylinder

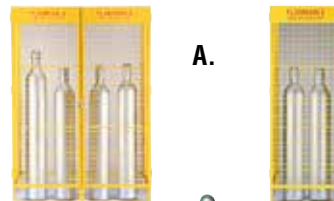

A.

B. Vertical Cylinder Pallets

Securely holds 4, 6 or 8 vertical 9" diameter cylinders securely in place for easy storage or transporting by forklift. Hinged dividers provide convenient access. All welded steel construction. Fork tubes are 5" wide. Standard blue.

CAT. NO.	CYLINDERS	L X W X H	LBS.
116615	4	23" x 34" x 40"	120
116625	6	33" x 34" x 40"	154
116635	8	43" x 34" x 40"	186



B.

C. Horizontal Storage Cabinets

For storage of either full or empty 33 lb. or 43 lb. LP cylinders.

CAT. NO.	CYL.	DOORS	L X W X H	LBS.
116050	4	1	30" x 41" x 42"	249
116060	8	1	30" x 41" x 72"	358
116070	12	2	42" x 41" x 72"	440
116080	16	2	60" x 41" x 72"	586

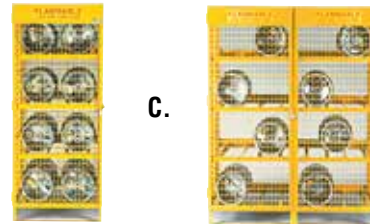

C.

D. Model 701-86

Constructed of 1" O.D. x 14 gauge steel tubing welded for strength. Base plate is designed for hauling boxes when needed.

CAT. NO.	WHEEL DESCRIPTION	H X W	LBS.
70186	10" x 2" solid rubber tire	48" x 21"	32



D.

E. Model 142-K19

Deluxe models have refinements and features, such as dual handle bars and hand grips for better control and stability when moving loaded units. Equipped with a tool box, a cylinder hold chain, hose hook and welding rod holder tubes.

CAT. NO.	WHEEL DESCRIPTION	H X W	LBS.
142K19	10" x 3 1/2" pneumatic	46" x 30"	31



E.

SHIPPING INFORMATION: 1 Week, F.O.B. Wichita, KS



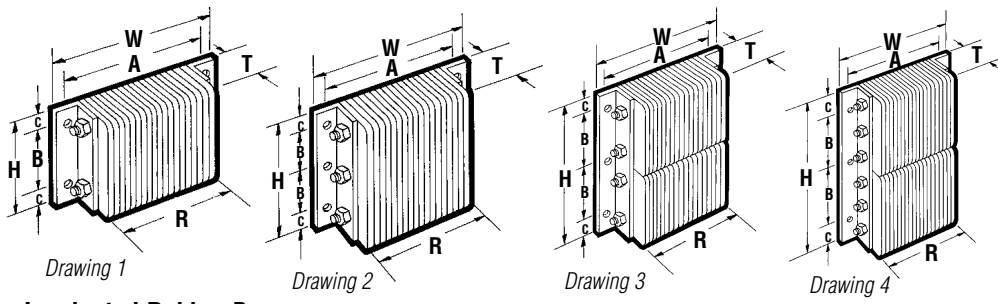

Laminated Rubber Bumpers

CAT. NO.	DRAWING NO.	H	W	T	R	A	B	C	LBS.
B451014	1	10"	16"	4½"	10"	14"	6"	2"	26
B451024	1	10"	26"	4½"	20"	24"	6"	2"	45
B451214	2	12"	16"	4½"	10"	14"	4"	2"	32
B451224	2	12"	26"	4½"	20"	24"	4"	2"	56
B452011	3	20"	13"	4½"	7"	11"	7"	3"	42
B452411	4	24"	13"	4½"	7"	11"	9"	3"	51
B61014	1	10"	16"	6"	10"	14"	6"	2"	33
B61024	1	10"	26"	6"	20"	24"	6"	2"	58
B61214	2	12"	16"	6"	10"	14"	4"	2"	41
B61224	2	12"	26"	6"	20"	24"	4"	2"	69
B62011	3	20"	13"	6"	7"	11"	7"	3"	52
B62411	4	24"	13"	6"	7"	11"	9"	3"	63

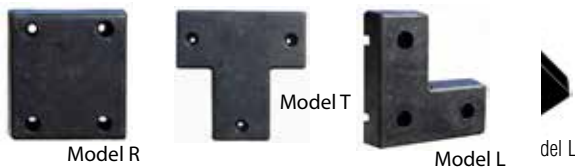

Molded Dock Bumpers

CAT. NO.	H X W X D	LBS.
R	12" x 13" x 4"	20
T	22" x 22" x 3"	30
L	18" x 18" x 4"	25

Wheel Chocks

CAT. NO.	H X W X D	LBS.
68-9	5½" x 8" x 9"	9
68-9-OR	5½" x 8" x 9"	9
88-8	8" x 8" x 9"	15
68-9/C15	Molded Wheel Chock w/15ft. Chain, no Wall Hanger	

Security Chain (Optional)

3/16" Proof Coil Chain, Bright Zinc Finish, 0.4 lbs./lin.ft.
 Standard Lengths – 10 ft.
 12 ft.
 15 ft.

- Includes attachment links and dock anchor/hanger.



SHIPPING INFORMATION: 1 Week, F.O.B. Norwalk, OH

Wheel Chocks

CAT. NO.	DESCRIPTION	DIMENSIONS L X W X H	LBS.
340094-002	Single-Wheel Chock	9½" x 5½" x 3½"	6
340094-006	Double-Wheel Chock	9½" x 5½" x 3½"	12



Dura Stat Car Stop

CAT. NO.	DESCRIPTION	DIMENSIONS L X W X H	LBS.
340094-007	Car Stop	72" x 6 x 4"	35.5



SHIPPING INFORMATION: 10 Business Days, F.O.B. Lorain, OH



Dock Bumpers

Laminated Rubber Bumpers
 Other styles and models available.
 Call Crown and have our sales department specify the correct size and design.

Chart Information
H – Overall Height
W – Overall Width
T – Overall Thickness
R – Width of Rubber Surface
A – Horizontal Anchor Holes - Center to Center (13/16" Holes)
B – Vertical Anchor Holes - Center to Center
C – Center of Anchor Hole to Top/Bottom Edge

Save-T® Wheel Chocks

Safety Sign
 10" x 14" plastic, safety yellow and black, four holes for easy installation – \$16.96 each.



Wheel Chocks

- Prevents accidental movement onto workers
- Use at both front and back of tire for extra security
- Used in aerospace, transportation, rolling equipment repair
- High-visibility yellow
- Bottom grit surface available

Car Stops

- Durable and damage resistant
- Will not crumble, crack, or deteriorate
- Resists oils and most chemicals
- Made in the U.S.A. from 100% recycled plastic
- High-visibility yellow
- Hardware not included

DOCK & DOOR



Folding Steel Security Gates

Now, provide day and night security with low cost steel folding gates. Does not obstruct air flow or light. All gates pivot and fold flat to the side. Double gate features drop pin at center to prevent movement. Rolls on casters.

Features:

- Made of sturdy 3/4" steel channel construction.
- Black enamel finish.
- Installs easily with all hardware included.
- Standard locking system will accept a padlock up to 1/2" diameter shaft.

*CUSTOM SIZES
AVAILABLE*



Door Gate

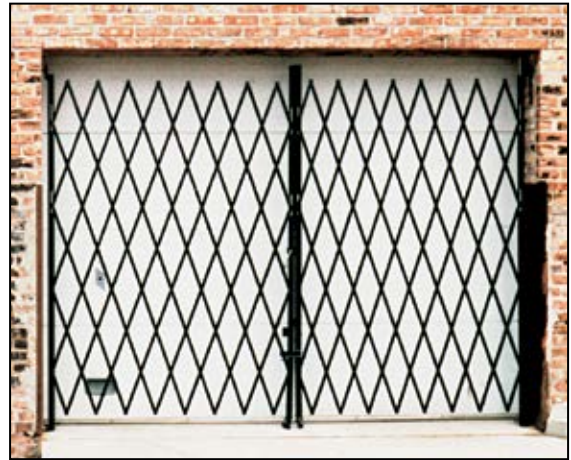

Double Folding Gate

Single Folding Gate

CAT. NO.	COLLAPSED		"IN-USE" HEIGHT	WIDTH	LBS.
	HEIGHT	HEIGHT			
D66	66"	-1"/ft.	4'	4'	38
D71	71"	-1"/ft.	4'	4'	40
D76	76"	-1"/ft.	4'	4'	44
D79	79"	-1"/ft.	4'	4'	46
SG-201	5 1/2'	5'	5 1/2'	5 1/2'	40
SG-202	6'	5 1/2'	5 1/2'	5 1/2'	45
SG-203	6 1/2'	6'	5 1/2'	5 1/2'	47
SG-204	7'	6 1/2'	5 1/2'	5 1/2'	50
SG-205	7 1/2'	7'	5 1/2'	5 1/2'	50
SG-206	8'	7 1/2'	5 1/2'	5 1/2'	69
SG-207	5 1/2'	5'	6 1/2'	5 1/2'	50
SG-208	6'	5 1/2'	6 1/2'	5 1/2'	55
SG-209	6 1/2'	6'	6 1/2'	5 1/2'	57
SG-210	7'	6 1/2'	6 1/2'	6 1/2'	62
SG-211	7 1/2'	7'	6 1/2'	6 1/2'	62
SG-212	8'	7 1/2'	6 1/2'	6 1/2'	77
SG-214	6'	5 1/2'	7 1/2'	7 1/2'	75
SG-215	6 1/2'	6'	7 1/2'	7 1/2'	62
SG-216	7'	6 1/2'	7 1/2'	6 1/2'	63
SG-217	7 1/2'	7'	7 1/2'	7 1/2'	70

Double Folding Gate

CAT. NO.	COLLAPSED		"IN-USE" HEIGHT	WIDTH	LBS.
	HEIGHT	HEIGHT			
DG-251	6 1/2'	6'	8'	8'	70
DG-252	7'	6 1/2'	8'	8'	78
DG-253	7 1/2'	7'	8'	8'	82
DG-254	8'	7 1/2'	8'	8'	104
DG-255	8 1/2'	8'	8'	8'	108
DG-256	6 1/2'	6'	10'	8 1/2'	86
DG-257	7'	6 1/2'	10'	8 1/2'	85
DG-258	7 1/2'	7'	10'	8 1/2'	95
DG-259	8'	7 1/2'	10'	8 1/2'	119
DG-260	8 1/2'	8'	10'	8 1/2'	132
DG-261	6 1/2'	6'	12'	8 1/2'	89
DG-262	7'	6 1/2'	12'	8 1/2'	103
DG-263	7 1/2'	7'	12'	8 1/2'	100
DG-264	8'	7 1/2'	12'	8 1/2'	133
DG-265	8 1/2'	8'	12'	8 1/2'	127
DG-266	6 1/2'	6'	14'	8 1/2'	123
DG-267	7'	6 1/2'	14'	8 1/2'	114
DG-268	7 1/2'	7'	14'	8 1/2'	118
DG-269	8'	7 1/2'	14'	8 1/2'	143
DG-270	8 1/2'	8'	14'	8 1/2'	162

Note: All single gates will lock on the left side unless requested otherwise.

Made in the U.S.A.

SHIPPING INFORMATION: 1 Week, F.O.B. Chicago, IL



Save-T® Insulated Curtain Walls

TMI's line of Insulated Curtain Walls and Partitions are the perfect alternative to permanent wall structures in cold storage or warehouse environments and an ideal solution for refrigerated trailers. Easy to install and even easier to maintain, Insulated Curtain Walls provide temperature separation in cooler and freezer environments.



Insulated Pleated Curtain Walls

- 18.5 oz. blue opaque with layer of bubble-pack insulation
- All openings include universal mounting sliding track hardware
- Stationary for warehouses or sliding for trailers and coolers
- Stationary walls include valance that attaches to hardware and curtain to create a top seal
- Stationary walls include black vinyl floor sweep to create a seal on the floor
- Layer of bubble pack and reflective aluminum foil to isolate temperature (R value 12)

CAT. NO.	OPENING SIZE (W X H)	SLIDING TYPE
IPC-8x8	8' x 8'	Single Panel-One Side
IPC-8x10	8' x 10'	Single Panel-One Side
IPC-8x12	8' x 12'	Single Panel-One Side
IPC-12x8	12' x 8'	Single Panel-One Side
IPC-12x10	12' x 10'	Single Panel-One Side
IPC-12x12	12' x 12'	Single Panel-One Side
IPC-24x8	24' x 8'	Double Panel-Bi-Parting
IPC-24x10	24' x 10'	Double Panel-Bi-Parting
IPC-24x12	24' x 12'	Double Panel-Bi-Parting

SHIPPING INFORMATION: 1-2 Weeks, F.O.B. Pittsburgh, PA



Strip Doors

The most common benefits of a strip door installation includes the ability to reduce energy costs, prevent contamination, improve environmental control and promote better workflows with increased employee safety. Aleco makes strip doors easy. Designed for quick installation and ease of use, Clear-Flex® II strip door formulations combined with MaxBullet® hardware provides the best quality, fastest installation available today.

Aleco® provides a full line of environmental control products to help conserve energy, increase productivity, and improve worker safety. With 40 years of experience supplying industrial and retail industries, Aleco has earned its name as a trade leader in strip doors, impact doors, partitions, custom enclosures, and floor protection products.

ABSOLUTELY NO TOOLS REQUIRED FOR HANGING STRIPS WITH MAXBULLET® STRIP DOOR HARDWARE.

- Reduce installation time by 75%
- Reduce replacement strip time by 90%
- Pair MaxBullet with Clear-Flex II strips for the ultimate strip door installation

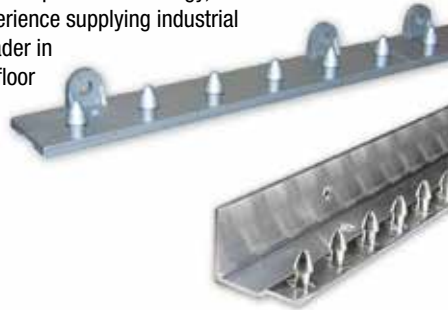

A. Auto Riser

Trailer Stand

Safety stand prevents tipping over of spotted trailers due to landing gear failure. Ergonomically designed positioning handles and the gas activated leveling system allows the Auto Riser to be the industry's easiest and fastest trailer stand to position. 100,000 lbs. static load capacity.

CAT. NO.	DESCRIPTION	LBS.
007-00275	5" x 30" Support Pad with height adjustments from 42" to 52.5"	175



A.

B. Phoenix® Docklites®

Wall Mount Model

CAT. NO.	DESCRIPTION	LBS.
DL-INC-LH/DL-42-ARM-DS	42" Dual Arm	19
DL-INC-LH/DL-60-ARM-DS	60" Dual Arm	24



Dock Light/
Fan Model

B.

Dock Light/Fan Model (not shown)

CAT. NO.	DESCRIPTION	LBS.
DL-INC-LH/DL-42-ARM-DS/DL-18-FAN	42" Reach	39
DL-INC-LH/DL-60-ARM-DS/DL-18-FAN	60" Reach	42

Option

CAT. NO.	DESCRIPTION	LBS.
GG-1	Glare Guard	1



Phoenix® Docklites®

- Improves productivity
- Reduces costly accidents

For decades, and in tens of thousands of installations, Docklite continues to quickly pay for itself by illuminating truck, trailer, and railcar environments — without interfering with workers or machines. Workers face less eyestrain and muscle fatigue.

SHIPPING INFORMATION: 1-2 Weeks, F.O.B. Pittsburgh, PA

Economy Steel Dockboards

- The Economy Steel dock board is designed to meet the demands of today's active docks that require moderate to high usage.
- Structural steel side curbs are fully welded to protect equipment run-off and for increased strength. Re-enforced steel legs prevent dockboard from moving between truck and dock. Lift chain allows for easy moving of this board.
- Economy Steel truck dock boards are available in capacities of 10,000 lbs. and 15,000 lbs. Special size boards are available upon request.
- These boards feature 3/8" steel treadplate with welded steel side curbs.
- Lifting chain is standard.



MANUAL & ELECTRIC PALLET TRUCKS 14% GRADE	PROPANE & GAS FORKLIFTS 19% GRADE	10,000 LB. CAPACITY 3/8" THICK LIFT CHAINS INCLUDED				15,000 LB. CAPACITY 3/8" THICK LIFT CHAINS INCLUDED	
		HEIGHT UP	HEIGHT UP	SIZE W X L	CAT. NO.	LBS.	CAT. NO.
3.5"	5"	60" x 36"	10ESB6036	310	15ESB6036	319	
5"	7"	60" x 48"	10ESB6048	395	15ESB6048	406	
7"	9"	60" x 60"	10ESB6060	488	15ESB6060	501	
8.5"	12"	60" x 72"	10ESB6072	572	15ESB6072	588	
3.5"	5"	72" x 36"	10ESB7236	410	15ESB7236	419	
5"	7"	72" x 48"	10ESB7248	500	15ESB7248	511	
7"	9"	72" x 60"	10ESB7260	650	15ESB7260	664	
8.5"	12"	72" x 72"	10ESB7272	770	15ESB7272	786	

Items highlighted in yellow are common sizes.

SHIPPING INFORMATION: Stock-2 Weeks, F.O.B. Queensbury, NY

Rail Dockboards

- Steel rail dockboards are designed for usage on all types of rail applications, such as box and refrigerated cars. Industries such as paper and lumber rely on these heavy-duty steel rail boards to move product in and out of rail cars.
- Every steel rail board is built to match the specifications of your dock. A completed rail dockboard work sheet is required with every order to assure proper sizing and capacity.
- All steel rail dockboards feature built-in lift loops for ease of moving. A durable box under structure fills up much of the gap between the dock and the rail car, and standard D-rings complete the locking of the board to the rail car and dock.
- Rail boards can be manufactured with flairs on either car or dock side to assist you with tight turning areas. Please contact Crown for these applications.
- Steel rail boards are available in capacities up to 80,000 lbs.
- Rail Dockboards rectangular or flared boards are available in capacities up to 40,000 lbs. Lift loops and spacer rings standard.
- Available in 15,000, 25,000 and 40,000 lb. capacities

SIZE W X L	DIM. "A" RANGE
96" x 36"	49" - 50"
96" x 48"	57" - 62"
96" x 60"	63" - 74"
102" x 36"	49" - 50"
102" x 60"	63" - 74"
120" x 36"	49" - 50"
120" x 48"	57" - 62"
120" x 60"	63" - 74"

Lifting Chains & Lifting Loops; Lifting Chains in Place of Lifting Loops - N/C

WARNING: Cancer and reproductive harm - www.P65Warnings.ca.gov



NOTE: Rail Dockboards are available in 10°, 20° & 30° flairs. Please consult Crown for dimensions and pricing.

SHIPPING INFORMATION: 3-4 Weeks, F.O.B. Queensbury, NY



Dock Equipment

Aluminum Dockplate

- Aluminum alloy for extra strength
- Hand slots for easy positioning
- 30" to 72" width options
- 24" to 72" length options
- ANSI approved

Aluminum Dockboards/Steel Side Curbs

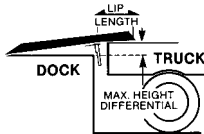

- Aluminum board absorbs stress
- Rolled edge for tire protection
- Bolted locking legs
- Lightweight for easier handling
- Positive traction
- Quality engineered
- ANSI approved

Steel Dockboard (T)

- All-welded steel construction
- Capacities from 15,000 to 40,000 lbs.
- Two four-hole pin pockets placed on each edge
- Fold-down lifting loops
- Double-bend design
- ANSI approved

Steel Red Pin Dockboard (C)

- For difficult trailer-to-dock positions
- Dual-pin locking system
- All-welded steel construction
- Capacities from 15,000 to 40,000 lbs.
- ANSI approved

SHIPPING INFORMATION:
1 Week, F.O.B. Fort Worth, TX

Flat plates — cannot run forklift over plate

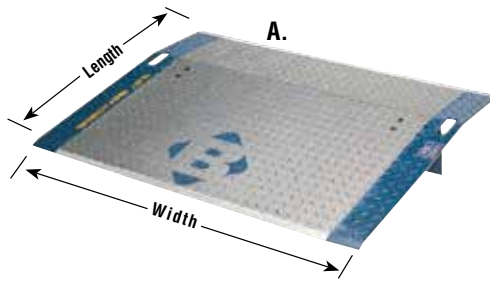

A. Aluminum Dockplate

3/8" Thick Tread Plate

CAT. NO.	H.D.*	W	L	CAPACITY (LBS.)	LBS.
A3636	3"	36"	36"	3269	64
A3648	5"	36"	48"	1722	86
A3660	7"	36"	60"	1445	105
A4836	3"	48"	36"	4342	79
A4848	5"	48"	48"	2429	99
A4860	7"	48"	60"	1660	119
A6036	3"	60"	36"	5305	97
A6048	5"	60"	48"	3132	127
A6060	7"	60"	60"	2421	157

1/2" Thick Tread Plate

CAT. NO.	H.D.*	W	L	CAPACITY (LBS.)	LBS.
B3636	3"	36"	36"	4175	79
B3648	5"	36"	48"	3455	106
B3660	7"	36"	60"	2710	130
B4836	3"	48"	36"	6554	93
B4848	5"	48"	48"	4895	122
B4860	7"	48"	60"	3612	164
B6036	3"	60"	36"	8337	122
B6048	5"	60"	48"	5516	161
B6060	7"	60"	60"	3761	200

⚠️ WARNING: Cancer - www.P65Warnings.ca.gov

C. Steel Dockboard (T)

15,000 Pound Capacity

CAT. NO.	H.D.*	W	L	LBS.
15T6048	5"	60"	48"	430
15T6060	7"	60"	60"	540
15T6072	8½"	60"	72"	625
15T7248	5"	72"	48"	495
15T7260	7"	72"	60"	625
15T7272	8½"	72"	72"	720

20,000 Pound Capacity

CAT. NO.	H.D.*	W	L	LBS.
20T6048	5"	60"	48"	490
20T6060	7"	60"	60"	588
20T7248	5"	72"	48"	568
20T7260	7"	72"	60"	682
20T7272	8½"	72"	72"	795

⚠️ WARNING: Cancer - www.P65Warnings.ca.gov

D. Steel Red Pin Dockboard (C)

15,000 Pound Capacity

CAT. NO.	H.D.*	W	L	LBS.
15C6048	5"	60"	48"	485
15C6060	7"	60"	60"	610
15C6072	8½"	60"	72"	710
15C7248	5"	72"	48"	550
15C7260	7"	72"	60"	690
15C7272	8½"	72"	72"	805

20,000 Pound Capacity

CAT. NO.	H.D.*	W	L	LBS.
20C6048	5"	60"	48"	490
20C6060	7"	60"	60"	588
20C7248	5"	72"	48"	568
20C7260	7"	72"	60"	682
20C7272	8½"	72"	72"	831

* H.D. = Height Difference between dock and truck bed.

⚠️ WARNING: Cancer - www.P65Warnings.ca.gov



B. Aluminum Dockboards/Steel Side Curbs

10,000 Pound Capacity

CAT. NO.	H.D.*	W	L	LBS.
AC6036	3"	60"	36"	127
AC6048	5"	60"	48"	163
AC6060	7"	60"	60"	202
AC6072	8½"	60"	72"	253
AC7236	3"	72"	36"	136
AC7248	5"	72"	48"	179
AC7260	7"	72"	60"	255

OPTION: EZ-ROLL PAIR

58

15,000 Pound Capacity

CAT. NO.	H.D.*	W	L	LBS.
BC6036	3"	60"	36"	145
BC6048	5"	60"	48"	201
BC6060	7"	60"	60"	247
BC6072	8½"	60"	72"	304
BC7236	3"	72"	36"	167
BC7248	5"	72"	48"	220
BC7260	7"	72"	60"	277
ACLC Lifting Chains				10

⚠️ WARNING: Cancer - www.P65Warnings.ca.gov

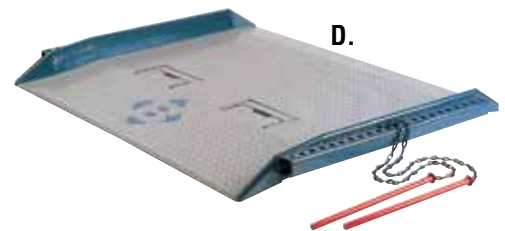
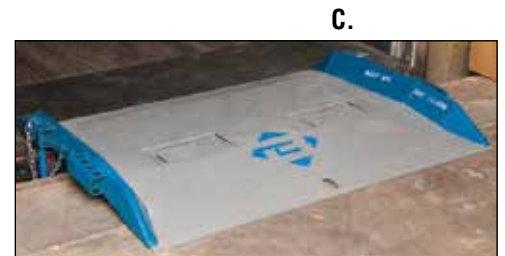

DOCK & DOOR

Other sizes available on all items. CALL FOR PRICING.

DOCK EQUIPMENT



AMERICA'S #1 DOCK LIFT BUILDER SINCE 1974 DOCK LIFTS

A SAMPLING OF MODELS:



Hand carts, four wheeled carts and pallet jacks

Product No.	Capacity	Platform Size	Lowered Height	Travel	Speed FPM	Power Unit	Wt (lb)
T2-50608	5,000	6' x 8'	8"	58"	12	5	2,400
T2-55610	5,500	6' x 10'	8"	58"	10	5	2,860
T2-50710	5,600	7' x 10'	8"	58"	10	5	2,990
T2-50810	5,000	8' x 10'	8"	58"	10	5	3,100



Powered pallet jacks, walkies, straddle stackers and small fork trucks

Product No.	Capacity	Platform Size	Lowered Height	Travel	Speed FPM	Power Unit	Wt (lb)
3200	8,000	6' x 8'	12"	58"	10	5	4,200
3280	8,000	8' x 10'	12"	58"	10	5	5,000
3300	10,000	6' x 8'	12"	58"	8	5	4,525
3380	10,000	8' x 10'	12"	58"	8	5	5,485



Fork Truck

Product No.	Capacity	Platform Size	Lowered Height	Travel	Speed FPM	Power Unit	Wt (lb)
3400	12,000	6' x 10'	15"	58"	7	5	5,500
3480	12,000	8' x 12'	15"	58"	7	5	6,900
3500	16,000	6' x 10'	16-1/4"	58"	8	7-1/2	5,800
3580	16,000	8' x 12'	16-1/4"	58"	8	7-1/2	7,200
3600	20,000	6' x 10'	17-1/2"	58"	8	7-1/2	6,900
3680	20,000	8' x 12'	17-1/2"	58"	8	7-1/2	8,100



Hand carts, four wheeled carts and pallet jacks

Product No.	Capacity	Platform Size	Lowered Height	Raised Height	Speed FPM	Power Unit	Wt (lb)
6568	5,500	6' x 8'	5"	58"	13	5	2,290
65610	5,500	6' x 10'	5"	58"	13	5	2,900



Powered pallet jacks, walkies, straddle stackers and small fork trucks

Product No.	Capacity	Platform Size	Lowered Height	Raised Height	Speed FPM	Power Unit	Wt (lb)
6868	8,000	6' x 8'	6"	58"	11	5	2,540
68710	8,000	7' x 10'	6"	58"	11	5	4,795
68810	8,000	8' x 10'	6"	58"	11	5	5,000
610610	10,000	6' x 10'	6"	58"	10	7-1/2	5,045
610710	10,000	7' x 10'	6"	58"	10	7-1/2	5,250
610810	10,000	8' x 10'	6"	58"	10	7-1/2	5,455

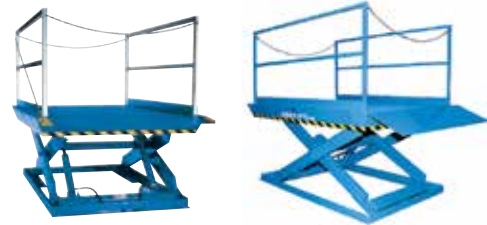

RECESSED
• T-Series

5,000 lbs to 6,000 lbs capacity



RECESSED
• 3000 Series

8,000 lbs to 20,000 lbs capacity



SURFACE MOUNT
• 6000 Series

5,500 lbs to 15,000 lbs capacity

This is just a sample of our many models

- WE HAVE THE MOST MODELS IN THE INDUSTRY
- WE HAVE THE BEST WARRANTY IN THE INDUSTRY
- WE HAVE THE BEST DELIVERIES IN THE INDUSTRY



CALL FOR ADDITIONAL MODELS AND PRICING

SHIPPING INFORMATION: 3 WEEKS F.O.B. ST. CHARLES, IL

A. FlexScreen

- Nylon rollers; galvanized track; coated steel wall brackets
- Vertical stiffeners, velcro and magnets are used to tightly seal the sides and allow for easy opening
- Standard track is straight roller track formed from 16-gauge hot-dipped galvanized steel for durability and long life; attaches quickly and easily to lintel of door opening or wall mount
- Wall mount model is available; call for pricing

CAT. NO.	OPENING SIZE (W x H)
SPS-IJ-8-8	8' x 8'
SPS-IJ-8-10	8' x 10'
SPS-IJ-9-8	9' x 8'
SPS-IJ-9-9	9' x 9'
SPS-IJ-9-10	9' x 10'
SPS-IJ-10-8	10' x 8'
SPS-IJ-10-10	10' x 10'
SPS-IJ-10-12	10' x 12'
SPS-IJ-12-10	12' x 10'
SPS-IJ-12-12	12' x 12'



A.

SHIPPING INFORMATION: 1-2 Weeks, F.O.B. Pittsburgh, PA



— A SENECA COMPANY —

FlexScreen

Keep pests out with the economical FlexScreen-Slide model. The easy-to-install FlexScreen slider can be attached under the header, or mounted to the inside wall with a bracket to allow the screen to be opened beyond the door frame and completely out of the doorway.

- Made from durable, all-weather vinyl coated-polyester which is fire retardant as well as mildew and UV resistant
- Safety strips sewn into curtain for screen visibility

DOCK & DOOR

B. Container Ramps

CAT. NO.	W X L	14% GRADE	19% GRADE	CAPACITY (LBS.)	LBS.
15CR6048	60" x 48"	5"	7"	15,000	489
15CR6060	60" x 60"	7"	9"	15,000	573
15CR6072	60" x 72"	8½"	11"	15,000	658
15CR6084	60" x 84"	10"	13"	15,000	742
15CR6096	60" x 96"	12"	15"	15,000	827

⚠ WARNING: Cancer - www.P65Warnings.ca.gov



B.



C.

C. Speedy Board®

CAT. NO.	W X L	14% GRADE	19% GRADE	CAPACITY (LBS.)	LBS.
15SB6048	60" x 48"	5"	7"	15,000	439
15SB6060	60" x 60"	7"	9"	15,000	523
15SB6072	60" x 72"	8½"	11"	15,000	607
15SB7248	72" x 48"	5"	7"	15,000	506
15SB7260	72" x 60"	7"	9"	15,000	605
15SB7272	72" x 72"	8½"	11"	15,000	703
20SB6048	60" x 48"	5"	7"	20,000	490
20SB6060	60" x 60"	7"	9"	20,000	588
20SB7248	72" x 48"	5"	7"	20,000	568
20SB7260	72" x 60"	7"	9"	20,000	682
20SB7272	72" x 72"	8½"	11"	20,000	795

⚠ WARNING: Cancer - www.P65Warnings.ca.gov

SHIPPING INFORMATION: 1 Week, F.O.B. Fort Worth, TX



Container Ramps

The Bluff Container Ramp allows you to safely navigate the transition from ground to the bed of the container. Ramps feature:

- Full-width stiffener which adds strength against the container
- Locking chains with a specially designed keeper that easily locks it into the container
- Sturdy grab notch bracket welded to the sides of the ramp

Speedy Board®

Fork cutouts are added to the leading edge of the board, allowing your driver the ability to "scoop" the board and move it into place and to retrieve it for storage when the job is done — all without the driver leaving the safety of the fork truck cage. The Speedy Board® (SB) Option can be added to TFL, TNB and SC boards at no charge. Use of the Speedy Board® is NOT recommended for below dock loading.



Van Walk Ramps

- Twin-touch deck for better traction when traveling in either direction
- Strong, lightweight interlocking aluminum construction makes ramps easily portable and convenient
- All Apron models complete with 8" apron; 3¼" position stop; safety chains
- All hook models complete with two heavy-duty safety hooks
- 4¼" side rail height
- 3¼" curb height

SHIPPING INFORMATION:
5 Days, F.O.B. Standish, MI

A. Van Walk Ramps



Apron Model



Hook Model



APRON MODEL

NOMINAL LENGTHS	MAX HT. RANGE	ACTUAL LENGTH	RATED CAP. (LBS.)	CAT. NO.	2900 SERIES			3900 SERIES			
					OVERALL WIDTH	USABLE WIDTH	WEIGHT (LBS.)	CAT. NO.	OVERALL WIDTH	USABLE WIDTH	WEIGHT (LBS.)
3'	9"	36"	3000	VR29032	28¾"	26¼"	36	VR39032	39¼"	37"	43
4'	12"	45"	3000	VR29042	28¾"	26¼"	41	VR39042	39¼"	37"	53
5'	18"	63"	3000	VR29052	28¾"	26¼"	54	VR39052	39¼"	37"	67
6'	21"	72"	2800	VR29062	28¾"	26¼"	57	VR39062	39¼"	37"	76
7'	27"	90"	2800	VR29072	28¾"	26¼"	72	VR39072	39¼"	37"	90
8'	31"	99"	2500	VR29082	28¾"	26¼"	78	VR39082	39¼"	37"	98
9'	34"	108"	2500	VR29092	28¾"	26¼"	86	VR39092	39¼"	37"	108
10'	37"	117"	2200	VR29102	28¾"	26¼"	93	VR39102	39¼"	37"	114
12'	46"	144"	1900	VR29122	28¾"	26¼"	110	VR39122	39¼"	37"	139
14'	52"	162"	1600	VR29142	28¾"	26¼"	123	VR39142	39¼"	37"	151
16'	61"	189"	1000	VR29162	28¾"	26¼"	147	VR39162	39¼"	37"	176

HOOK MODEL

NOMINAL LENGTHS	MAX HT. RANGE	ACTUAL LENGTH	RATED CAP. (LBS.)	CAT. NO.	2900 SERIES			3900 SERIES			
					OVERALL WIDTH	USABLE WIDTH	WEIGHT (LBS.)	CAT. NO.	OVERALL WIDTH	USABLE WIDTH	WEIGHT (LBS.)
3'	13"	39"	3000	VR29031	28¾"	26¼"	33	VR39031	39¼"	37"	41
4'	16"	48"	3000	VR29041	28¾"	26¼"	40	VR39041	39¼"	37"	49
5'	22"	66"	3000	VR29051	28¾"	26¼"	50	VR39051	39¼"	37"	65
6'	25"	75"	2800	VR29061	28¾"	26¼"	56	VR39061	39¼"	37"	70
7'	32"	93"	2800	VR29071	28¾"	26¼"	72	VR39071	39¼"	37"	90
8'	35"	102"	2500	VR29081	28¾"	26¼"	75	VR39081	39¼"	37"	93
9'	38"	111"	2500	VR29091	28¾"	26¼"	83	VR39091	39¼"	37"	106
10'	41"	120"	2200	VR29101	28¾"	26¼"	89	VR39101	39¼"	37"	109
12'	50"	147"	1900	VR29121	28¾"	26¼"	107	VR39121	39¼"	37"	133
14'	56"	165"	1600	VR29141	28¾"	26¼"	119	VR39141	39¼"	37"	148
16'	66"	192"	1000	VR29161	28¾"	26¼"	140	VR39161	39¼"	37"	172

WARNING: Cancer and reproductive harm - www.P65Warnings.ca.gov



Yard Ramps

Ramps are built for ground to dock and ground to trailer applications. The double acting pump brings the yard ramp up to the desired height quickly for fast, efficient product transport. Serrated steel grating provides for traction, as well as offers escape for snow, ice and debris build-up. Standard ramp positioner attaches to forklift fork and makes moving the dock ramp a breeze!

This portable yard loading ramp is easy to move, goes anywhere and lets you move freight quickly. Large 16" solid pneumatic tires work well on hard packed surfaces. Optional tandem wheels are ideal for loose soil conditions.

Wheel Risers

Wheel risers provide a way to raise trucks up to dock height. Top deck of ramp is a level off for rear wheels to rest on. All trailers should be even with the dock or above the dock. Wheel risers provide a ramp for the truck to back up on. Wheel risers are designed to accommodate over the road trailers, as well as single-axle trucks.

SHIPPING INFORMATION:
Yard Ramps: 3-4 Weeks
Wheel Risers: 3-4 Weeks
F.O.B. Queensbury, NY



B. Yard Ramps

Standard capacities are 16,000, 20,000, 25,000 and 30,000lbs. 68" and 80" widths are standard. Features: All-steel yard ramp with manual hydraulic pump; Working range from 38" to 62"; 8" H curbs; 16" lip.

CAT. NO.	CAPACITY (LBS.)	OVERALL WIDTH	USABLE WIDTH	LENGTH	LBS.
16YSD6830	16,000	68"	63"	30'	4175
16YSD6836L	16,000	68"	63"	36'	5120
16YSD8030	16,000	80"	75"	30'	4985
16YSD8036L	16,000	80"	75"	36'	5850
20YSD6830	20,000	68"	63"	30'	4385
20YSD6836L	20,000	68"	63"	36'	5335
20YSD8030	20,000	80"	75"	30'	5200
20YSD8036L	20,000	80"	75"	36'	6065

Options: **YSD-OPT 01** - TOW BAR- For moving long distances. **YSD-OPT 03** - TANDEM WHEEL-4 WHEELS TOTAL-for soft, uneven surfaces. **YSD-OPT 04** - NO UNDERCARRIAGE DEDUCT-For Permanent Mount.

WARNING: Cancer and reproductive harm - www.P65Warnings.ca.gov

C. Wheel Risers

40,000 lb. capacity per pair. Available in 6", 8", 10" and 12" heights, these steel wheel risers provide a safe loading dock environment. Standard width is 24" for tandem wheels. 30" top length is for single axle trucks, and 84" top length is designed for tractor-trailers. Each riser comes standard with either lifting chains, Fork Pockets or mounting tabs for moving or permanently affixing to ground.

CAT. NO.	HEIGHT	WIDTH	LENGTH	TOP LENGTH	INCLINE LENGTH	WEIGHT PAIR STEEL (LBS.)	WEIGHT PAIR ALUMINUM (LBS.)
WR62448	6"	24"	48"	30"	18"	396	158
WR624102	6"	24"	102"	84"	18"	780	312
WR82454	8"	24"	54"	30"	25"	502	200
WR824108	8"	24"	108"	84"	25"	936	374
WR102460	10"	24"	60"	30"	32"	640	354
WR1024114	10"	24"	114"	84"	32"	1124	448
WR122466	12"	24"	66"	30"	38"	772	408
WR1224120	12"	24"	120"	84"	38"	1288	514

WARNING: Cancer and reproductive harm - www.P65Warnings.ca.gov

Industrial Bicycles

Bicycle

- A true industrial-grade bike, ideal for locations such as corporate campuses, chemical plants, refineries and other facilities for basic, reliable transportation.
- 26" x 2.125" wheels, featuring 11-gauge extra thick spokes, industrial rims.
- Fully lugged, hand-brazed frame made of heavy gauge 1" tubing.
- 1/2" x 3/16" chain, coaster brake, industrial knockout front hub, thickly padded seats and wide fenders.

Tricycle With Rear Basket

- Fully lugged, hand brazed one-piece frame with integrated rear steel platform.
- 450-lb total capacity.
- Rear coaster (foot) brake, automotive type front drum brake, Workman Clincher wheels, 7/8" steel rear axle, pillow block axle bearings, 26" x 2.125" front tire with 24" x 2.125" rear tires, 1/2" x 3/16" chain.
- 21" x 15" x 9" rear basket.

Industrial Bicycles

- Heavy-duty bicycles designed, welded, painted and assembled in the USA.
- Both models are available in black, safety orange and safety yellow.

CAT. NO.	DESCRIPTION	LBS.
INB	Industrial Bicycle	60
ADB-CB	Industrial Tricycle with Rear Basket & Air Tires	130
ADB-CB-L4B	Industrial Tricycle with Rear Basket & Airless Solid Tires	120



INB Industrial Bicycle

The Classic American Bike - but with a big difference. These are built for day-in, day-out use. The features are what make the "Industrials" the bike of choice among leading companies all over the world. Many styles are available. Contact Crown Lift Trucks for other options.

ADB-CB Industrial Tricycle
(shown with optional front basket & rear fenders)



SHIPPING INFORMATION: 2-4 Weeks, F.O.B. Conway, SC

MouseCart

The MouseCart is making its way through distribution centers and warehousing operations in the United States. You can't help notice as the carts glide effortlessly past the old-style push-pull carts as order picking and routine tasks become quicker and easier.

Made in the U.S.A., the MouseCart has been designed for faster, more efficient use of time in filling parts orders, stock items, janitorial, maintenance, materials handling, and simply moving around for a host of reasons.



MouseCart

The MouseCart is highly maneuverable in both large facilities, where it's important to get from one end to the other and back in a timely manner, and smaller applications with tight aisles or restrictive spaces.

- Made of durable non-abrasive polyethylene plastic
- Foot brake
- Parking brake
- Back side storage
- Rubber casters
- Color: Gray

CAT. NO.	SIZE (W X H X D)	LBS.
MouseCart	29 1/2" x 42" x 60"	65

SHIPPING INFORMATION: 1-3 Weeks, F.O.B. Fresno, CA



Forklift Service At Your Fingertips

Request forklift service, discuss your rental needs or contact your dealer — all from the convenience of your smartphone or tablet. The Crown Service Request app provides quick access to Crown service to help you maximize uptime!



Let us fix it right the first time! Submit a service request and you will be connected to service experts with industry-leading response times.



Have a support question? Submit your inquiry by tapping the 'Contact Us' button. A Crown representative will review your inquiry and contact you shortly.



Need to find your nearest Crown dealer? The 'My Dealer' section offers easy access to location and contact information for a dealer in your area.



Need to rent a lift truck now? Tap the 'Rent Now' button and connect directly to a Crown representative to discuss your needs.

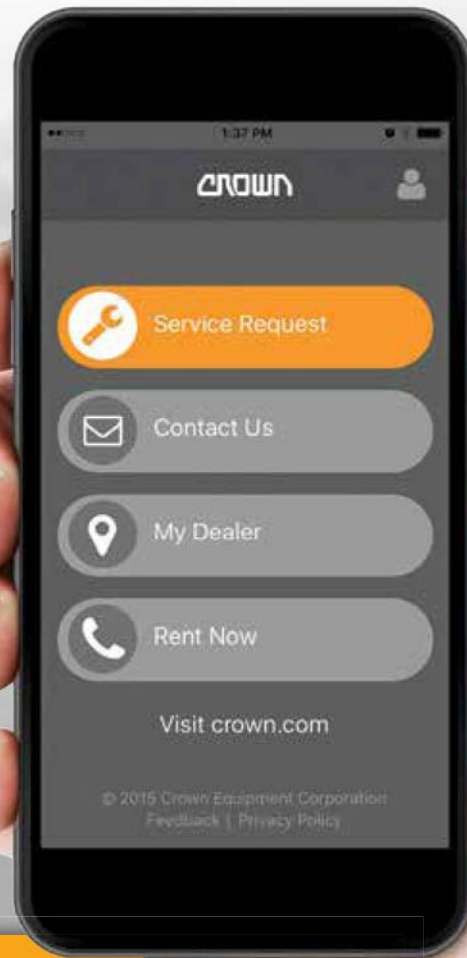

DOWNLOAD
The Crown Service Request app today!



For technical support, please email us at mobile.development@crow.com.



• **It's Easy To Order!**

You may order by phone, fax or mail. Call us from 8:00 a.m. to 5:00 p.m.; use our 24-hour fax number, or simply mail us your order. Whichever method you choose, your order will be processed within 24 hours of receipt, guaranteed!

• **Freight Policy**

For those items which are sold F.O.B. shipping point, freight can be billed either prepay and add or collect. Call us and we will work with our vendors to get the lowest possible price.

• **Easy Credit!**

✓ Terms are net 10 to all established accounts.

✓ We accept Visa, MasterCard and American Express.



✓ If you are a new customer and would like to open an account, please furnish three local trade references and the name of your bank.

• **Competitive Pricing**

While our everyday pricing represents superior value for quality products, we also offer special savings on large orders, as well as annual contract pricing. Call us for details. All prices in this catalog reflect buyer's net cost and do not include taxes or assembly.

TERMS & CONDITIONS:

• **Safety Standards**

You acknowledge that it is your sole responsibility to provide proper safety devices for your particular application or use and to comply with all federal, state and local laws, rules and regulations relating to safety standards.

• **Freight Damage**

Please ensure that all goods are carefully inspected for transit damage or loss before accepting delivery. If loss or damage has occurred, you must immediately note it on the freight bill and have the driver acknowledge your note. Please do not refuse the shipment; file a claim with the carrier. The cost of replacement is the trucker's responsibility. Our responsibility ends when the trucker accepts the shipment.

• **Limitation of Liability**

Prices and product specifications are subject to change without notice. Crown's sole liability on any claim of any kind whatsoever shall be limited to, at Crown's option, repair or replacement of, or cash or credit refund for, the merchandise in question. In no event shall Crown's liability exceed the purchase price of the merchandise in question, and no other claim or remedy of any kind (including, but not limited to, incidental or consequential damages) shall be available in connection with the use or performance of merchandise purchased from us.

Steel surcharges that we were aware of prior to the printing of this catalog have been included in the price. Due to the volatility of this situation, additional surcharges may need to be added to orders once they have been placed. Unfortunately, these charges will be included in our final billing.

Catalog Index

Aisle Signs 80, 81, 101-105
Attachments (Lift Trucks) 24, 29, 172-175, 210-213, 217-220
Barriers 11, 45, 82-83, 85-86, 112-117
Batteries 180-191
Battery Handling Equipment 44, 173, 180-191
Battery Watering Systems 180-191
Bicycles 257
Bins 98, 226-233
Bollards 11, 108
Bulk Container 178, 203
Bumpers 249
CAD Warehouse Design 2-5, 52-57
Cabinets
Cylinder 245, 247, 248
Modular 44, 97, 98-99, 234-236
Safety (Flammable) 247
Storage 226-240, 245, 247-248
Carts
Aluminum 43, 192-193, 205-208, 209
Battery Transfer 186-187
Bulk 177-179, 203
Electrical 202
Elevating 48, 154-159
Mail 198, 203
Mother/Daughter 47, 211, 219-220
Plastic 197, 257
Steel 47, 194-220
Stockpicking 47, 194-220, 224-225
Trailer 47, 210-213, 217-220
Wire 196, 199-201
Casters 221-223
Charging Equipment 180-191
Cleaning Equipment 38-39, 46
Column Protectors 11, 106-112
Containers
Plastic 178, 226-233
Steel 178-179, 233
Wire 43, 76, 78
Conveyors 66-67, 150, 170-171
Curtains/Partitions 250
Cylinder Trucks 246, 248
Design/Layout 2-5, 52-57
Desks 44, 124-132, 237
Dock Equipment
Bumpers 249, 252-253, 255-256
Fans 137-141, 251
Plates 252-256
Dollies 192-195
Drum Equipment 241-246, 248
Ergonomic Mats 118-123
Ergonomic Positioners 22-23, 160-169, 205
Eye Wash 191
Fans 47, 137-141
Fencing/Gates/Wire Enclosures 11, 45, 82-86, 250
Floor Scrubbers 38-39, 46
Floor Striping 43, 101-105
Fork Extensions/Protectors 172
Fork Lifts 12-23, 28, 30-31, 48, 152-153
Gates/Fencing/Wire Enclosures 11, 45, 82-86, 251
Guardrails 7, 45, 111-114, 116-117
Hand Pallet Trucks 12-13, 208
Hand Trucks 192-195
Hoppers (Self Dumping) 178-179
HVLS Fans 47, 137-141
In-Plant Offices 9, 45, 144-145
Installation 49
Label Holders 80-81
Ladders 150-153, 206, 209
Layout/Design 2-5, 52-57
Lift Tables 22-23, 48, 160-169
Lift Truck Attachments 24, 29, 172-175, 210-213, 217-220
Lift Trucks 12-23, 28, 30-31, 48, 152-153
Lights 46, 103-105, 142-143, 251
Lockers 86, 236-240
Machinery Guards 7, 83, 85, 114
Maintenance Platforms/Lifts 46, 154-159, 224-225
Maintenance/Service 25-27, 32-33

Mats 118-123
Mezzanine Accessories 10, 146-149, 150, 152-153
Mezzanines 10, 45, 146-149
Modular Drawer Cabinets 44, 97, 98-99, 234-236
Modular Offices 9, 45, 144-145
Netting 82-86
Packaging Supplies 133-136
Packing Stations 124-132
Pallet Dispenser 115
Pallet Jack Stop 174
Pallet Positioner 22-23, 48, 160-169
Partitions/Screens 9, 84, 251, 255
Personnel Carriers/Lifts 35-37, 48, 154-159
Platform Trucks 200-220, 224-225
Portable Lift Tables 22-23, 160-161
Rack Guards 11, 77, 82-83, 85-86, 106-111
Racks
Bar 71, 73
Bin 94
Cantilever 68, 72
Carton Flow 44, 74, 94
Coil 69
Die Storage 69, 89
Decking 76-78
Pallet 6, 41-42, 48, 56-69, 75, 80
Portable Stacking 22-23, 160-161
Reel (Cable) 73, 202
Ramps (Walk/Yard/Curb) 255-256
Rug Rams 174
Safety Cabinets 245, 247-248
Safety Netting 82-89, 171
Scales 176
Scissor Lift Tables 22-23, 48, 160-169
Screens/Partitions 9, 84, 250
Self-Dumping Hoppers 178-179
Service/Maintenance 25-27, 32-33
Shelf/Rack Tags & Signs 80-81, 101-105
Shelving
Bin 94, 98-99, 198, 228-233
Bulk 88, 93
Rivet 8, 44, 87-88, 91, 96
Steel 8, 88-90, 94-95, 97
Wire 197-199
Shipping/Packaging Supplies 133-136
Shop Desks 44, 124-132, 236
Sideloaders 48, 70-71
Signs 80-81, 101-105
Slings 175
Speed Bumps/Car Stops 116, 249
Storage Cabinets 226-240, 245, 247-248
Stretch Wrap 135-136
Strip Doors 251
Striping (Floor) 43, 101-105
Sweepers/Scrubbers 38-39, 46
Systems Integration 44, 66-67
Totes 203
Trailer Stabilizing Jacks 251
Trailers 47, 210-213, 217-220
Trash Cans 178-179, 203
Trucks
Bulk 203
Canvas 203
Cylinder 246, 248
Drum 241-245
Hand 192-195
Hand Pallet Trucks 12-13, 208
Lift 12-23, 28, 30-31, 48, 152-153
Platform 210-220, 224-225
Tilt 165-166, 192-195
Utility Vehicles 35-37, 48, 154-159
Vertical Lift Module 46, 100, 154-159
Waste Containers 177-179, 203
Wheel Chocks 249
Wire Containers 43, 76, 78, 92-94
Wire Decking 43, 76, 78, 92-94
Wire Enclosures/Fencing/Gates 11, 45, 82-86, 250
Work Platforms 10, 152-159, 209, 214-220, 224-225
Work Stations 44, 124-132, 237

Crown has 76 branch locations and 25 independent dealer locations to serve your needs nationwide.

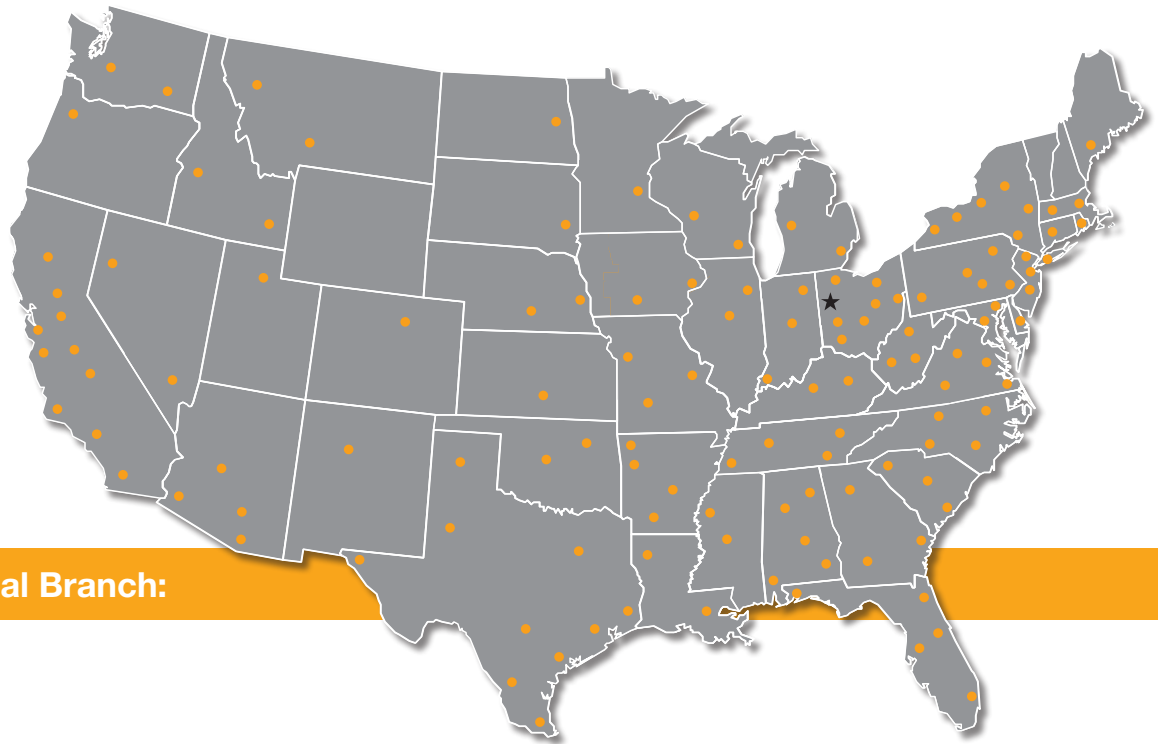

Contact Your Local Branch:



Scan the QR code to access a digital version of this catalog. To purchase select warehouse products online, visit shop.crown.com.



crown.com

Because Crown is continually improving its products, specifications are subject to change without notice.

Crown, the Crown logo, the color beige, and Crown Lift Trucks, are trademarks of Crown Equipment Corporation in the United States and other countries.

Other trademarks are the property of their respective owners.

Copyright 2009-2024 Crown Equipment Corporation
SF18204-B Rev. 10-23 Vol. 25
Printed in U.S.A.