

Operator Manual



*Pneumatic
LPG & Diesel Fuel*

You Must be Trained



WARNING

It's the law, you must be trained and certified to operate this truck. (OSHA § 1910.178, Rev. 1999)

You or others around you can be seriously injured or even killed if you don't use this truck correctly.

Read and obey all warnings and instructions in this Manual* and on the truck.

Head, arms, hands, legs or feet outside the operator area can be pinned or crushed whenever the truck is moving. Stay within the operator area and **stop the truck completely before getting off.**

Tipovers and falls from docks can cause serious injury or even death. Grip the steering wheel tightly, brace your feet and lean away from the direction of fall. **Make sure you are safe.**

You can be trapped or crushed by objects protruding or poking into the operator area. **Look where you are going.**

Inspect your truck before starting work, make sure it is in good working order.

* Additional copies of this Operator Manual and all Truck Labels can be obtained from Crown Equipment Corporation, New Bremen, Ohio 45869 U.S.A.

All rights reserved under International and Pan American copyright conventions
Copyright 2008 Crown Equipment Corp.



IT'S THE LAW, YOU MUST BE TRAINED AND CERTIFIED

Federal law states that only properly trained operators are permitted to operate a powered industrial truck and that your employer must train you and certify that you are qualified to operate this powered industrial truck. (OSHA §1910.178, Rev. 1999)

Do not operate this truck in your work place until you have been trained and certified by your employer.



You could be killed or seriously injured if you are not adequately trained for lift truck operation!

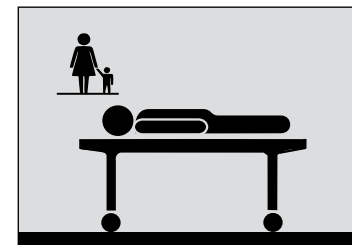

Protect Yourself

! Know the Hazards

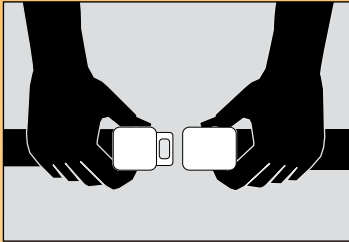

WEAR YOUR SEAT BELT

Falling from a truck can cause serious injury or even death.

- Fasten your seat belt and pull it snug before operating your truck. Keep it fastened until you leave the truck.
- Stay with your truck. Don't jump from an overturning or falling sit-down, counterbalanced truck. **Note:** This is not like end control rider trucks, where it is recommended that the operator exit the truck in these emergencies.

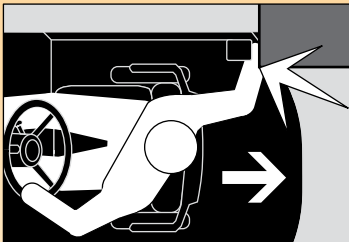

DRIVE CAREFULLY

- Never stick your foot, hand, head or any part of your body outside the operator area, no matter how slow the truck is moving. Anything caught between the truck and a fixed object will be crushed or even cut off.
- Stay away from the edge of docks and ramps. Make sure dock boards are secure. Check that trailer wheels are chocked. You could be seriously injured or even killed in a fall from a dock or dockboard.
- Keep your truck under control at all times. Drive at a speed that allows you to stop safely. Be even more careful on slippery or uneven surfaces. Do not drive over objects on the floor.

! Know the Hazards



LOOK WHERE YOU'RE DRIVING

- Always be alert to the area around you and watch where you are driving. You could be pinned or crushed by objects intruding or poking into the operator area.
- Be sure that any equipment added to the truck (terminal, fan, clipboard, etc.) does not block your vision or interfere with safe and efficient operation of this truck.

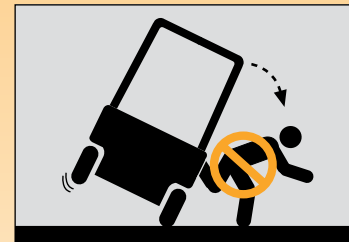

AVOID FALLS AND TIPOVERS

Tip-overs are very serious accidents. You can be crushed or even killed by the falling truck if you try to jump clear. Keep your seat belt fastened, grip the steering wheel tightly, brace your feet, and lean away from the direction of fall. The best way to prevent injury is to know where you are at all times and follow the rules of safe truck operation.

- Be extremely careful when working around docks, dockboards and trailers.
- Use forward tilt only when you have the load in a rack, over a stack or close to the floor.
- Travel with the load or forks close to the ground and mast tilted back. Watch for overhead obstructions. Perform all truck movements smoothly and at a speed that will give you time to react in an emergency.
- An unloaded truck can tip over also. Be just as careful using an unloaded truck as you are a loaded one.



Continued next page...

Know the Hazards

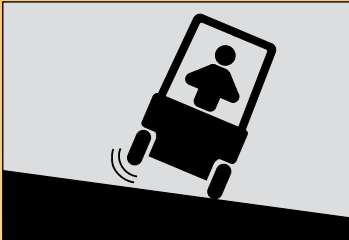

WHEN OPERATING OUTDOORS

- Slow down when traveling on slippery roads or slippery surfaces.
- Avoid traveling in areas which are flooded or where there are bumps, holes, or loose material that can cause the truck to tip or swerve.
- Do not drive your truck on soft ground.
- Stay away from curbs, rails, ditches or other obstacles.
- Do not drive on road shoulders. They can be soft and may collapse.
- When entering buildings, be careful not to exceed floor weight limits.

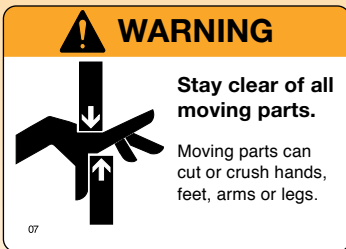

USE YOUR TRUCK SAFELY

- Keep your hands and feet away from all moving parts such as masts, chains or wheels. Make sure the load backrest is in place, when required.
- Never stand on or under the forks, or allow anyone else to stand on or under them. The only way to lift people is with an approved platform. Never allow passengers on the truck. There is no safe place for them.
- Before you leave your truck:
 - Come to a complete stop, lower forks to the floor and shut the truck off.
 - Place the direction control in neutral and apply the parking brake. Chock wheels if on an incline.

This page
left blank
intentionally

Warning	2
You Must be Trained	3
Protect Yourself	4
Contents	8
What's in it for You?	9
Your Sit-Down Rider	10
Lift Truck Parts	12
Hard Cab option	14
Capacity & Load Center	18
Capacity Plate	20
Display	22
Power On & Off	23
Braking	24
Optional Armrest	26
Raise/Lower, Tilt & Accessories	27
Traveling	28
Daily Safety Check	32
Be a Safe Driver	34
Refueling, Propane (LPG)	38
Refueling, Diesel	42
Air-filled Tires	43
Notes	44
Warning Labels	45

WHAT'S IN IT FOR YOU?

The better you understand your truck and how to use it, the better and safer operator you can be. Here are some guides to using this manual.

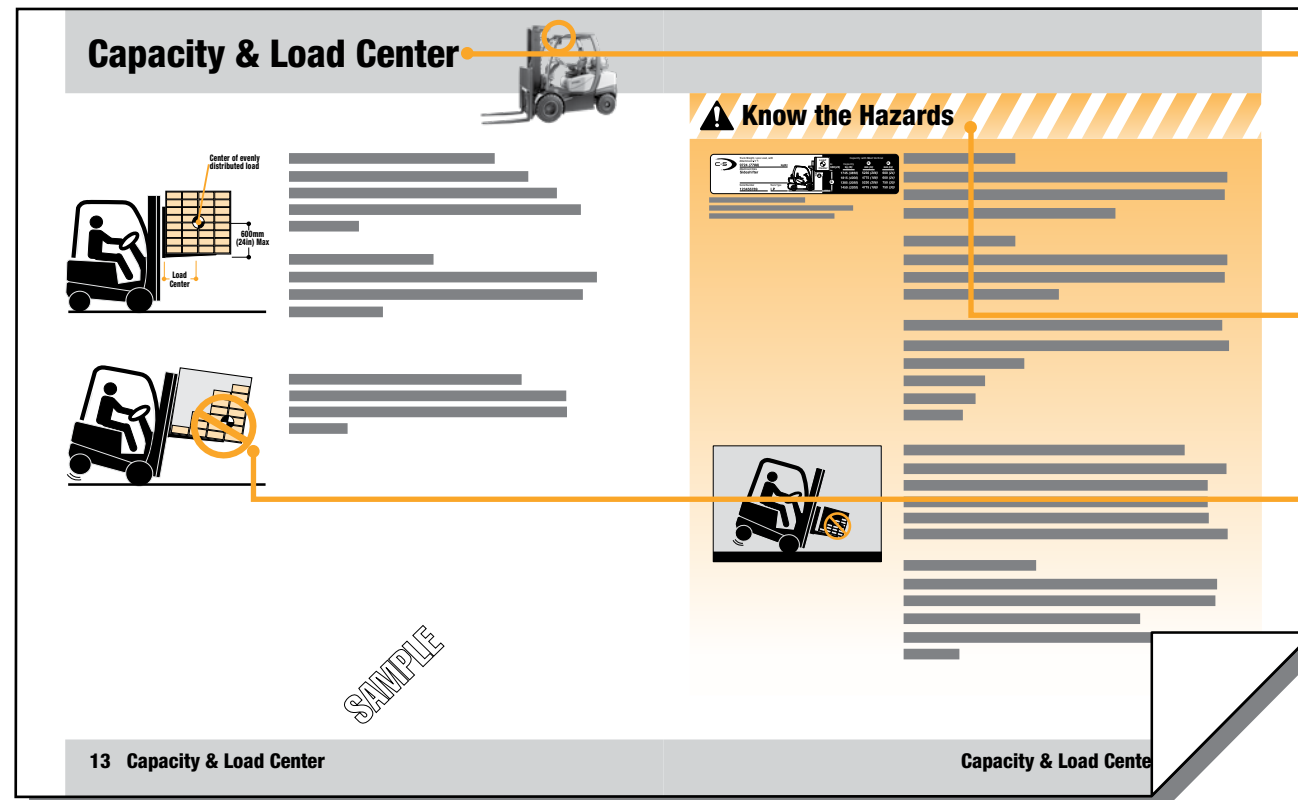

QUICK LOCATORS

In addition to the "Contents" page you can use page headings to find topics. Some pages also have a picture of the truck in the corner showing features or functions covered on that page.

"KNOW THE HAZARDS"

Watch for and read these special blocks. You will find information about possible safety hazards and how to avoid them.

HOW-TO-DRAWINGS

On many pages you will find pictures as well as text to help you understand how to use your truck safely and productively.

Your Sit-Down Rider



SIT-DOWN RIDERS

Your sit-down rider truck lifts and stacks loads. It is also designed to move loads over long distances.

YOUR RIDER LIFT TRUCK IS NOT AN AUTOMOBILE

With a load it may weigh more than 4 automobiles, and the steer wheels are in the rear instead of the front.

FORK FUNCTIONS, STANDARD AND OPTIONAL

Standard fork or hydraulic functions are Raising and Lowering the forks plus Tilting the mast. Accessories such as Sideshift or Carton Clamp may also be included. Your company has decided which features are needed in your work area and should train you how to use them.

HOW TO DRIVE YOUR TRUCK

Sit down, fasten your seat belt and pull it snug. Adjust the seat and steering wheel to their most comfortable positions. Keep your hands on the controls and your entire body inside the operator area. Look in the direction you are going.

GIVE YOUR BODY A BREAK

Take advantage of stop time. Flex your arms and legs. Staying alert will help you be a better and safer driver.

BUILT TO STANDARDS

This truck was designed and built to current industry and government standards and guidelines. For more information see the following:

- American National Standards Institute (ANSI/ITSDF) B56.1
(Download free from www.itsdf.org)
- Occupational Safety and Health Act (OSHA) §1910.178, Rev. 1999
(Download free from osha.gov)
- Underwriters Laboratory (UL) 558
- National Fire Prevention Association (NFPA) 505

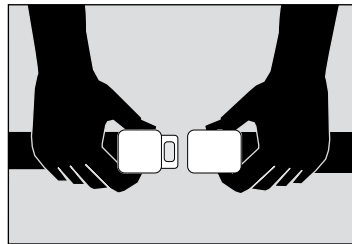

Hands on Controls

Seated

Seat Belt Fastened



Lift Truck Parts

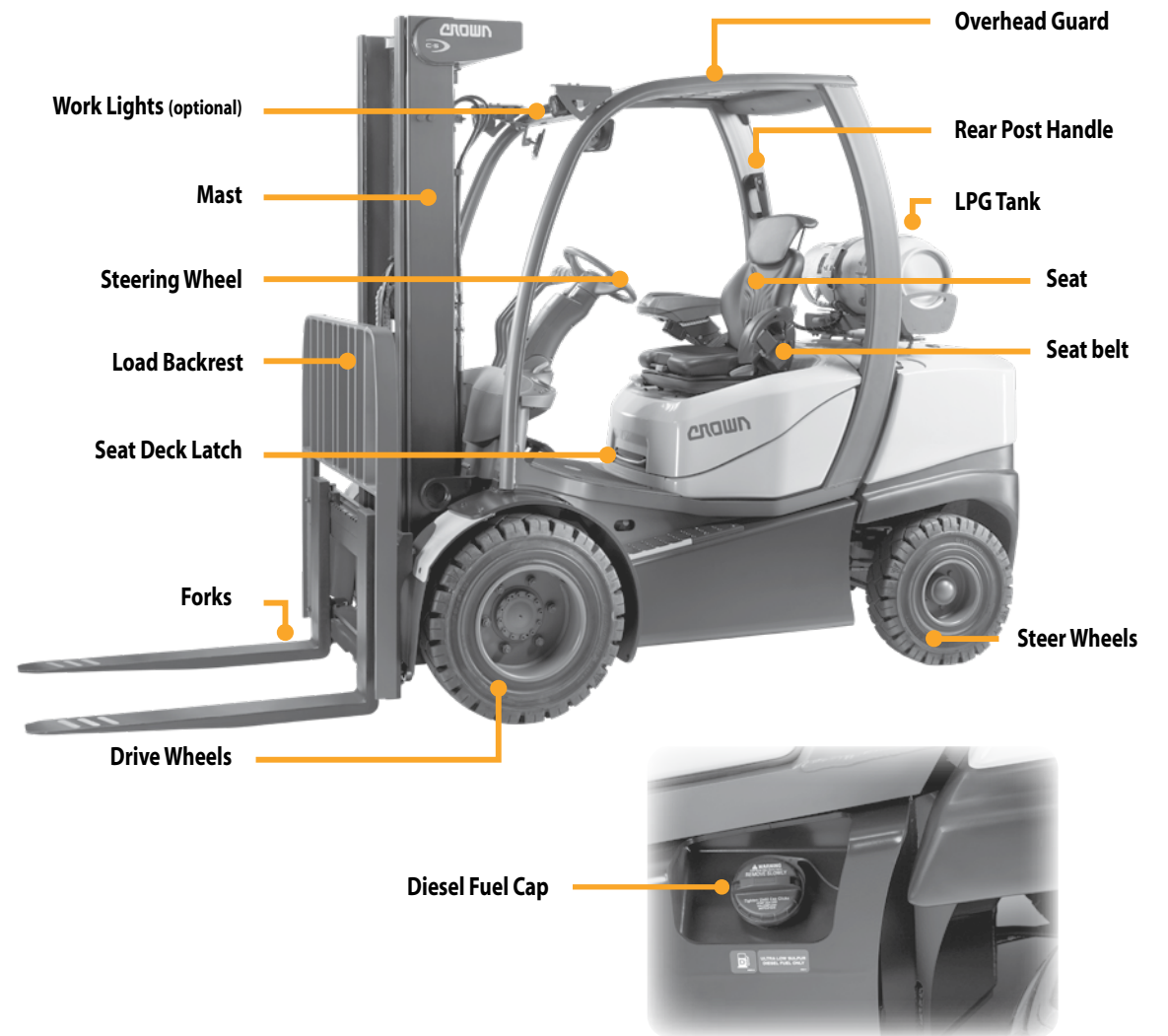
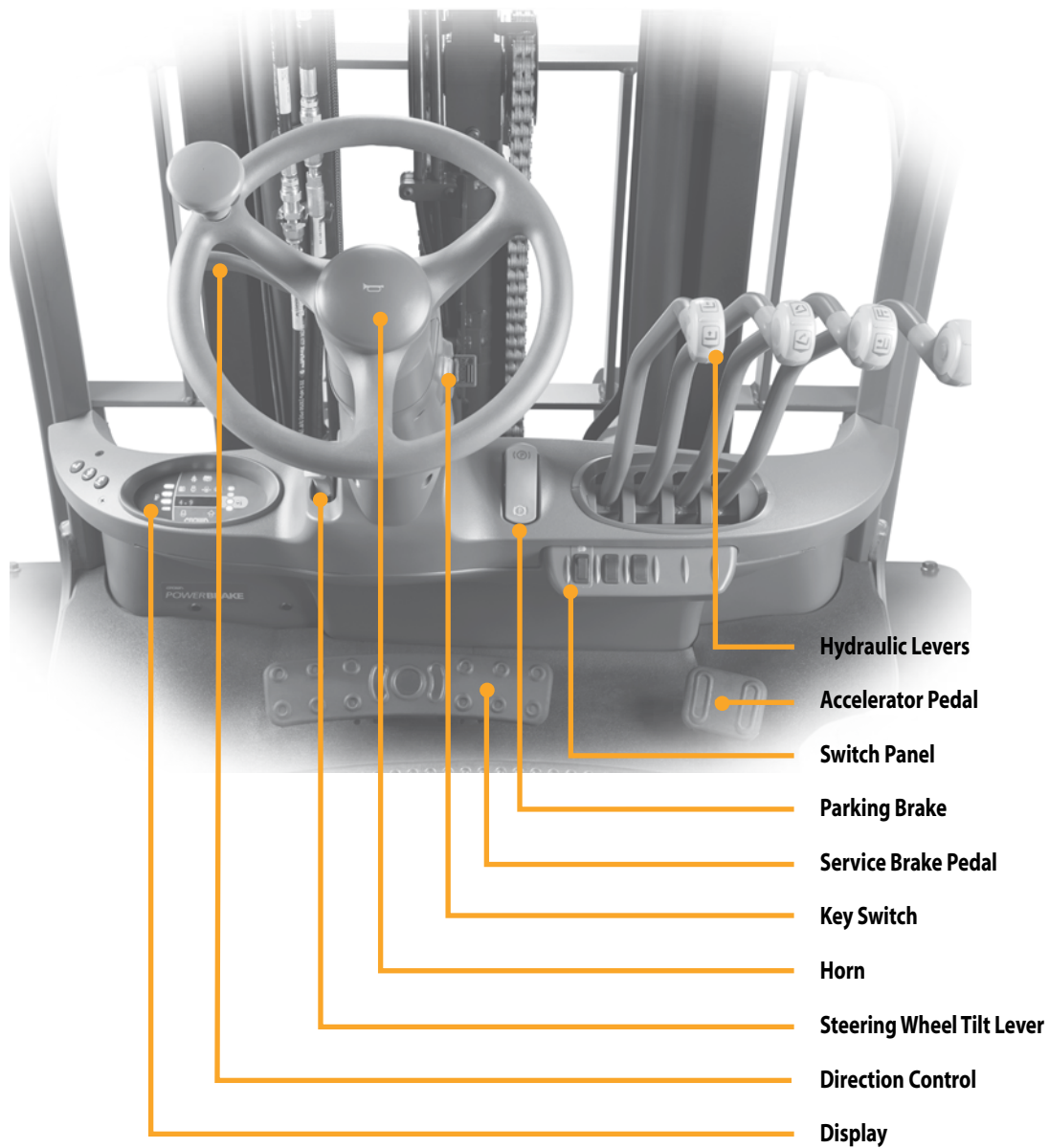

Hard Cab option

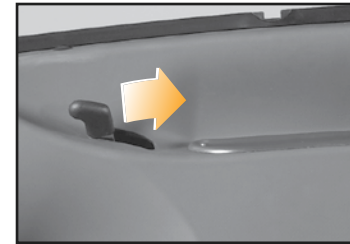
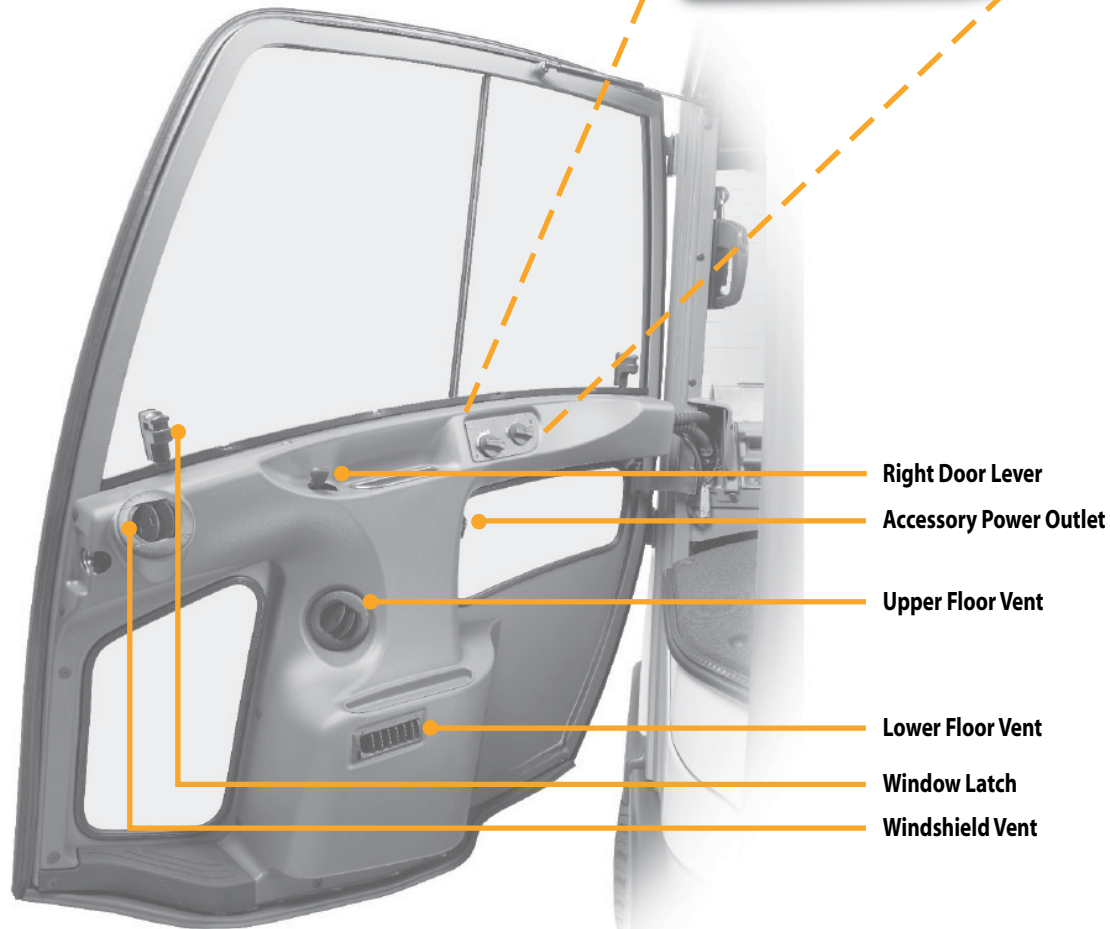
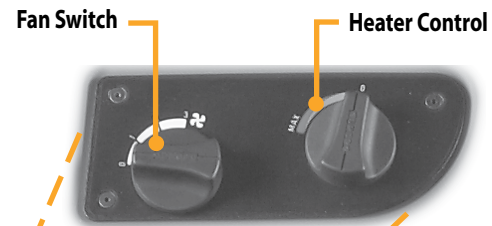

DOOR OPERATION

To enter the cab, pull the handle to open the door. Climb aboard your truck and close the door before you start the vehicle.

To exit, grab the door handle grip and slide it backward. Push the door to open.

Close the doors after leaving the cab.

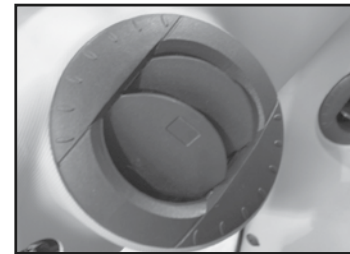

HEAT AND VENTILATION CONTROL

- Set the fan switch to the desired speed.
- Adjust the Heater Control to increase or decrease the temperature in the cab.

You can use the fan switch to circulate air throughout the cab. The vents are fully adjustable and can be used to direct the air where you want it.

WINDSHIELD DEFOG AND DEFROSTING

Turn on the heater and fan switch, and adjust the vents to defog/defrost the windshield before you drive your truck. Once the windshield is defrosted, use your windshield wiper to clear your windshield.

Know the Hazards

USE YOUR TRUCK SAFELY

Do not open the door while the truck is moving. Head, arms, hands, legs or feet outside an open door could be crushed or even cut off whenever the truck is moving. Keep the door closed and **stop the truck completely before getting off.**

You can be trapped or crushed by objects protruding or poking into the operator area. The heated cab glass will not stop a protruding object. **Look where you are going.**

Hard Cab option, continued



WINDOW OPERATION

Squeeze the door window latch then slide the window open or closed.



HINGED WINDOW option

To open the rear window, lift the window handle to the upward position and the window will open with a slight push.

This page
left blank
intentionally

Know the Hazards

LOOK WHERE YOU'RE DRIVING

Driver distractions can cause accidents resulting in injury or even death.

- Don't use cell phones or similar devices while operating the truck.
- Keep the windows clean and free of frost. Stay alert for pedestrians and other vehicles.
- Travel in the direction that gives you the best visibility.

Capacity & Load Center

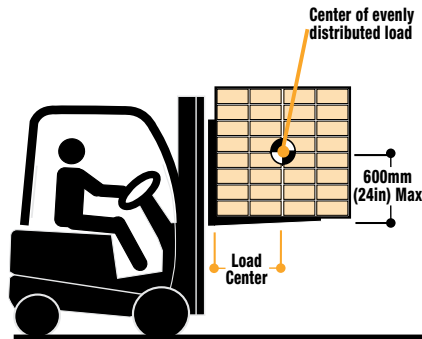

WHAT IS YOUR TRUCK CAPACITY?

Capacity is the load (including pallet or container that can be lifted to a given height at a given load center. See the capacity plate on your truck. Make certain you use the correct units of measure.

WHAT IS LOAD CENTER?

Load center is the distance from the load backrest or vertical face of the fork to the center of an evenly distributed load.

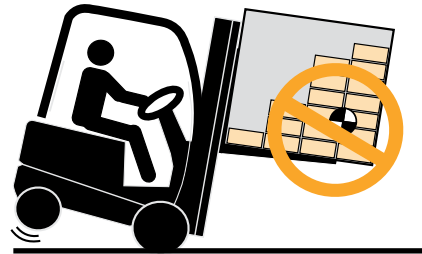

LOADS MUST BE EVENLY DISTRIBUTED

Your truck could tip over, in any direction, if a load is shifted to the front or side of a pallet or container.

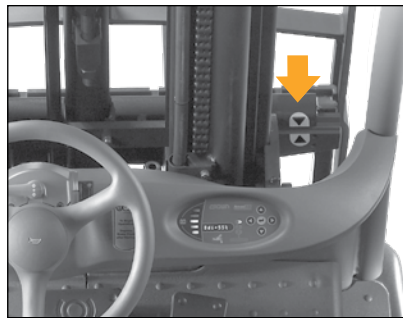

LOAD POSITION CAN AFFECT STABILITY

Capacities shown on your capacity plate are with the mast vertical and load centered. Be extra careful when tilting a load or using sideshift. (This also applies to other accessories or attachments your truck may have, such as carton clamp, push-pull, etc.)

Make sure your load is centered before you raise, lower, or travel.

The forks should be at least two-thirds (67%) the length of the load. Crown recommends the forks be three-fourths (75%) the length of the load. Make sure the forks do not extend beyond the load.

Use minimum fork tilt to pick up or place a load.

Know the Hazards

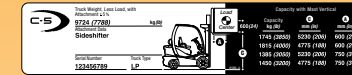

SAMPLE CAPACITY PLATE
The information shown on this sample plate does not apply to your truck.

KNOW YOUR LOAD

Do not exceed the capacity shown on your truck's capacity plate. Be careful when handling long, tall, or wide loads. Do not handle unstable loads.

EXCEEDING TRUCK CAPACITY CAN CAUSE AN ACCIDENT

Know the capacity of your truck as shown on your capacity plate. Make certain you use the correct units of measure. Pay attention to:

- Weight of load
- Load center
- Lift height
- Position of mast

CENTER THE LOAD

Your truck could tip over if a load is shifted to the front or side of a pallet or container. Make sure your load is evenly distributed and centered over the forks.



HYDRAULIC OPERATIONS CAN AFFECT STABILITY

Capacities shown on your capacity plate are with the mast vertical. Be extra careful when tilting a load. (This also applies to other accessories or attachments your truck may have, such as sideshift, carton clamp etc.)

TIRES WILL AFFECT CAPACITY AND STABILITY

This model truck can be equipped with either solid pneumatic or air-filled tires. Capacity and stability will be affected by the tires selected.

Caution: If you ever drive a different sit-down truck, even if it looks similar, be careful. Capacity and stability may not be the same.

Capacity Plate



CAPACITY PLATE INFORMATION

The capacity plate is on the overhead guard. It contains:

- Truck serial number
- Capacity information (load, load center and lift height)
- Truck type (a fire safety rating)
- Truck weight, Less Load, with Attachments $\pm 5\%$
- Attachment information (if any)

AFTER AUGUST 2017: READING YOUR CAPACITY PLATE

Capacity may be reduced as lift height **C** increases.

For example: On the sample plate, 1815kg (4000 lb) can be lifted to 4775mm (188 in). But above 4775 (188), to 5230 (206), capacity is reduced from 1815 (4000) to 1745 (3850).

Capacity is reduced as load center **A** increases.

For example: On the sample plate, 1815kg (4000 lb) can be lifted if the load center is 600mm (24 in). But if the load center is increased to 750mm (30), capacity is reduced from 1815 (4000) to 1450 (3200).

SAMPLE CAPACITY PLATE
The information shown on this sample plate does not apply to your truck.

Caution: You may not increase capacity if load center is less than shown on your capacity plate.

Note: ANSI/ITSDF B56.1 requires that all data be shown first in Metric units and then USA units.

BEFORE AUGUST 2017: READING YOUR CAPACITY PLATE

Capacity may be reduced as lift height **A** increases. *For example: On the sample plate, 1815kg (4000 lb) can be lifted to 4775mm (188 in). But above 4775 (188), to 5230 (206), capacity is reduced from 1815 (4000) to 1745 (3850).*

Capacity is reduced as load center **B** increases. *For example: On the sample plate, 1815kg (4000 lb) can be lifted if the load center is 600mm (24 in). But if the load center is increased to 750mm (30), capacity is reduced from 1815 (4000) to 1450 (3200).*

		Units of measure, kg/mm(lb/in) Capacity with Mast Vertical		
Load Center	Capacity	A		B
		kg (lb)	mm (in)	mm (in)
600 (24)	1745 (3850)	5230 (206)	600 (24)	600 (24)
	1815 (4000)	4775 (188)	600 (24)	600 (24)
	1385 (3050)	5230 (206)	750 (30)	750 (30)
	1450 (3200)	4775 (188)	750 (30)	750 (30)

Caution: You may not increase capacity if load center is less than shown on your capacity plate.

Note: ANSI/ITSDF B56.1 requires that all data be shown first in Metric units and then USA units.

Know the Hazards

TRUCK WEIGHT

Dockboards, elevators and some floors have limited capacity. Check your capacity plate for the weight of your truck. Remember to add the weight of the load you have on the forks. Make certain you use the correct units of measure.

TRUCK TYPE

Some truck types are not permitted in areas where there are fire hazards. Watch for marked areas. *For example: You must not drive a type LP or D truck into an area restricted to LPS or DS trucks.*

ATTACHMENT DATA

If an attachment on your truck does not match the information given on your capacity plate, don't operate your truck. Your capacity plate may be wrong. Report the problem to your supervisor.

C-S	Truck Weight, Less Load, with Attachment $\pm 5\%$	kg (lb)	Capacity with Mast Vertical		
	9724 (7788)		Capacity	C	A
Attachment Data: Sideshift			kg (lb)	mm (in)	mm (in)
Serial Number	Truck Type		1745 (3850)	5230 (206)	600 (24)
123456789	LP		1815 (4000)	4775 (188)	600 (24)
			1385 (3050)	5230 (206)	750 (30)
			1450 (3200)	4775 (188)	750 (30)

OTHER LIFT HEIGHTS & LOAD CENTERS

Contact Crown for capacities at lift heights or load centers not given on your capacity plate.

Display

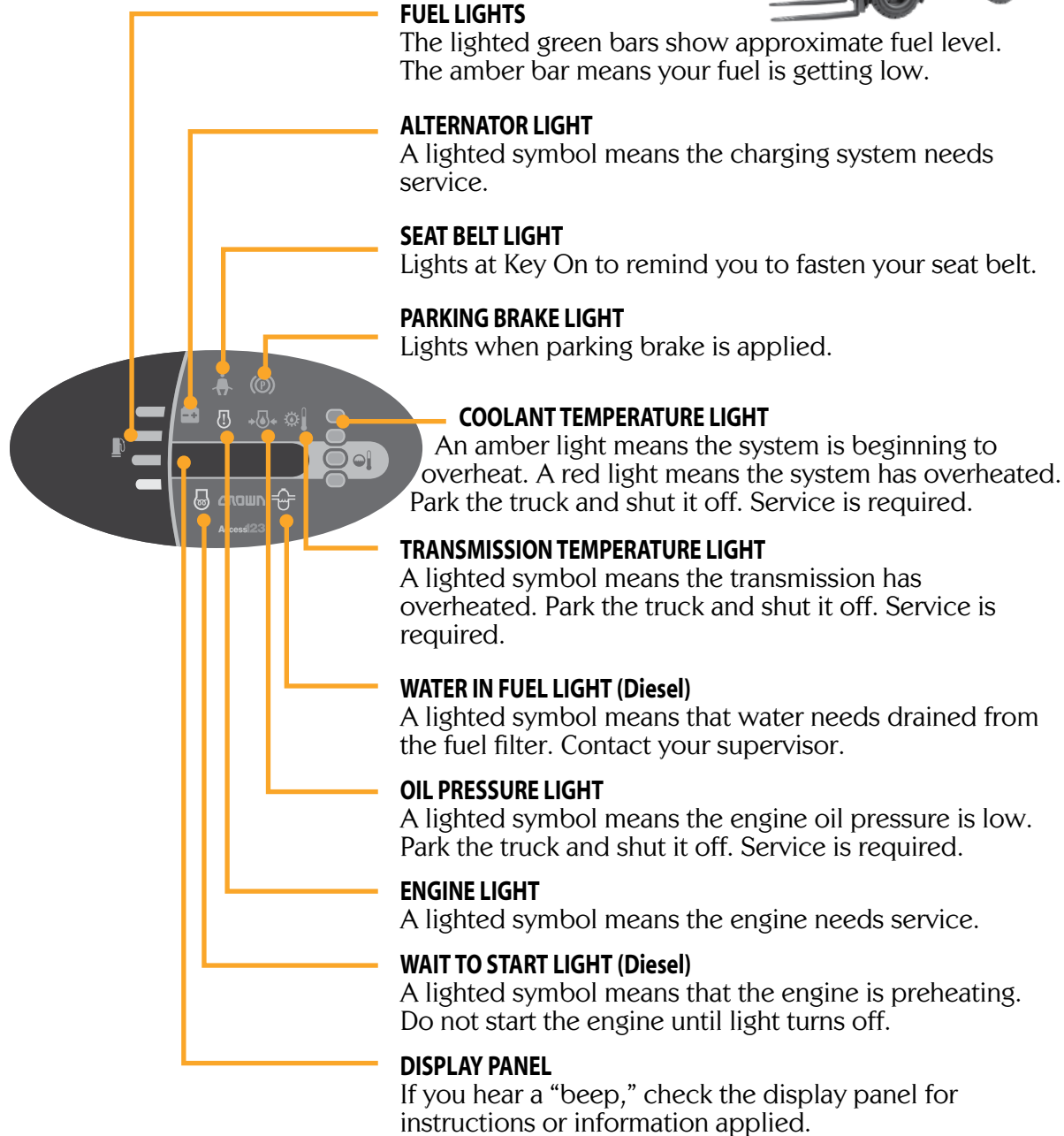

Power On & Off

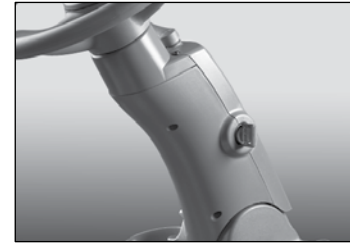

KEY SWITCH

- Turn the key clockwise from the red dot to the yellow dot to start the engine. Check that the seat alarm and all indicator lights are working.
- Let go of the key and it will return to ON (green dot).
- Turn the key counterclockwise to OFF (red dot) to shut the truck off. Always turn the key to OFF when leaving the truck. Apply the parking brake.

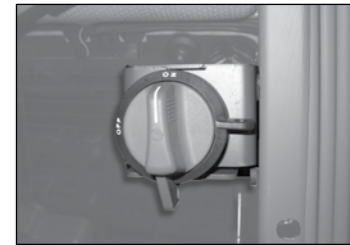

EMERGENCY DISCONNECT (LPS and DS option)

In case of an emergency, turn the emergency disconnect counterclockwise to the OFF position.



Know the Hazards

CARBON MONOXIDE POISONING

Don't inhale the engine exhaust. It contains carbon monoxide which is a colorless and odorless gas. It can cause unconsciousness or even death with little or no warning.

Don't operate the truck in unventilated areas where the exhaust gas can accumulate.

Braking



SERVICE BRAKE

Your truck will be equipped with either one or two service brake pedals. The further you push the brake, the sooner the truck will stop. Use the brake in an emergency, on ramps, or in busy areas.

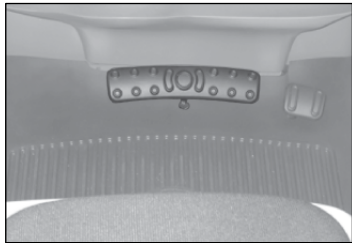

SINGLE BRAKE PEDAL

The large pedal is the inching/brake pedal. Push the pedal all the way down for full braking. Partially depressing the pedal while applying the accelerator will give you controlled slower speed, or “inching”.

Caution: On an incline the truck may roll before drive engages.

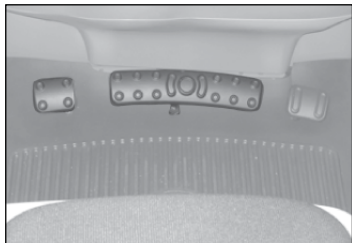

2 PEDAL OPTION

The smaller left pedal is the inching/brake pedal. Push the pedal all the way down for full braking. Partially depressing the pedal while applying the accelerator will give you controlled slower travel, or “inching”.

The large center pedal provides full braking only. When fully depressed, both pedals provide the same degree of braking.

Note: With either pedal option, you must use full engine speed (with the inching/brake pedal applied) to obtain maximum performance for any hydraulic operation.



PARKING BRAKE LEVER

Move the parking brake lever toward the seat to apply the parking brake.

Squeeze the parking brake lever and move it away from the seat to release the parking brake.

Before you leave your truck, always put the parking brake on and make sure the truck does not move. The alarm will sound if the brake is not applied.

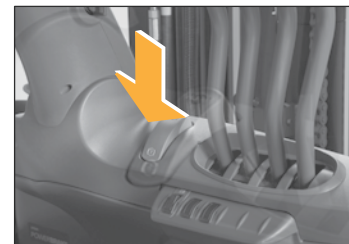

POWER PARKING BRAKE ON

Press the end of the parking brake rocker switch nearest the seat to apply the parking brake.

Before you leave your truck, always put the parking brake on and make sure the truck does not move. The alarm will sound if the brake is not applied.

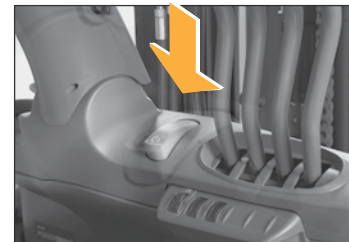

POWER PARKING BRAKE OFF

Press the end of the parking brake rocker switch away from the seat to release the parking brake.

! Know the Hazards

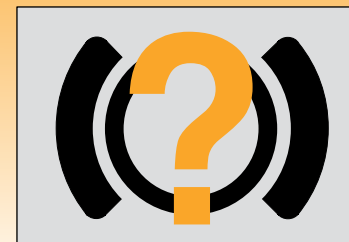

MAKE SURE YOUR BRAKES WORK

Test the brakes on your truck at the start of each shift. Know the distance it takes to stop before you start working.

If the stopping distance is too long for you to stop safely, don't drive the truck. Apply the parking brake and report any problem to your supervisor.

Raise/Lower, Tilt & Accessories



Raise/Lower lever

Tilt lever

Accessory levers (optional)

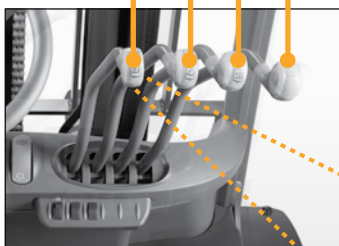

HYDRAULIC LEVER OPERATION

Pull a lever toward you, away from the mast, and you'll get the action shown in the bottom symbol on the lever. Push the lever away from you, toward the mast, and you'll get the opposite action shown in the upper symbol.

The farther you move the lever from neutral, the faster the action will be.



For example: Pull the Raise/Lower lever toward you to raise the forks, as shown in the bottom symbol.



Push the lever away from you to lower the forks.

LIFT AND TILT INTERLOCK

Lift and tilt interlock will limit raise if the mast is tilted forward beyond 2°. To continue raising, return the mast to vertical.

When the forks are elevated, mast forward tilt is limited.

Note: You must use full engine speed (with the inching/brake pedal applied) to obtain maximum performance for any hydraulic operation.

Optional Armrest



OPTIONAL ARMREST

Adjust the armrest so that you can fully operate the hydraulic levers.

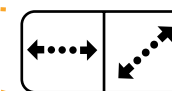

Lift the Raise/Lower lever to pull up or push down the armrest.

Lift the Forward/Back lever to slide the armrest forward or backward.

Make certain the armrest locks into place.

Note: Do not make any adjustments while operating the truck.



HORN

Your armrest is equipped with a horn button. Use it to warn pedestrians and other drivers.

Use your horn when you leave an aisle or come to a crosswalk or intersection.

! Know the Hazards

HYDRAULIC OPERATIONS CAN AFFECT STABILITY

Capacities shown on your capacity plate are for loads that are centered and level. Be extra careful when tilting a load. (This also applies to accessories or attachments your truck may have such as sideshift, carton clamp, push-pull, etc.)

Traveling



BEFORE YOU DRIVE

Fasten your seat belt and pull it snug.

Adjust the operator seat and steering wheel to a comfortable position. Make sure that you can fully operate the controls.

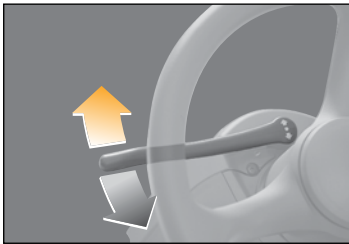

TRAVEL DIRECTION AND SPEED

Move the direction control away from you, toward the mast, to travel forks first. Move the control toward you, away from the mast, to travel power unit first (forks trailing).

Use the accelerator on the floor (right pedal) to control travel speed. The farther you push it down, the faster the truck will go.

When you sit down you must place the direction control in neutral before you select a direction of travel.

Note: You must use full acceleration (with the inching/brake pedal applied) to obtain maximum performance for any hydraulic operation.

AVOID TRUCK DAMAGE WHEN CHANGING TRAVEL DIRECTION

You can damage the truck if you are traveling too fast when changing direction of travel.

Do not change direction of travel until the truck has slowed to about 5 mph or less.

OPTIONAL INVERSION CONTROL

With this option your company can set a speed range at which the truck will change travel direction.

Use the service brake to slow down or stop your truck.

! Know the Hazards

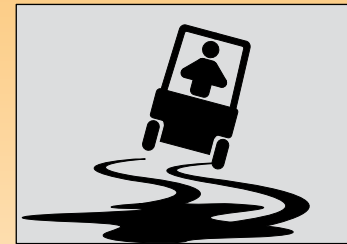

SLOW DOWN FOR SPILLS OR WET FLOORS

Powder or liquid spills can cause slippery floors. Slow down or you could lose control of steering and braking. Be careful and allow for a longer stopping distance.

Don't run over objects on the floor.

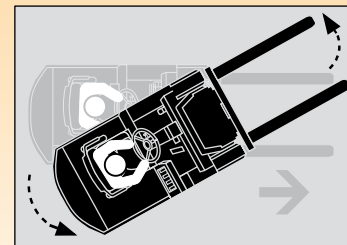

POWER UNIT SWING

Be careful turning while traveling forks first. The power unit will swing wide in the opposite direction. Make sure you have clearance, and watch out for people in the area.

KNOW THE OUTDOOR HAZARDS (see page 30)

Outdoor usage of this truck requires even more care, especially when operating on gravel, unpaved surfaces, uneven terrain, or when snow, ice or water is present.

PREVENT DAMAGE TO TRUCK

Slow to 5 mph or less before reversing direction of travel.

Continued next page...

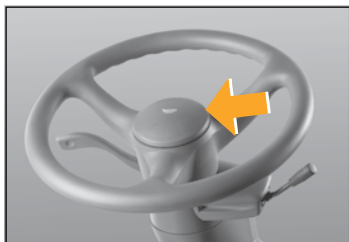

HORN

Press the center of the steering wheel to blow the horn. Use it to warn pedestrians and other drivers.

Use your horn when you leave an aisle or come to a crosswalk or intersection.

Note: Your truck may be equipped with an optional horn button on the rear post handle.



This page
left blank
intentionally

Know the Hazards

LOOK WHERE YOU'RE GOING

Driver distractions can cause accidents resulting in injury or even death.

- Don't use cell phones or similar devices while operating the truck.
- Travel in the direction where you have the best visibility.

Daily Safety Check



CHECK YOUR TRUCK BEFORE STARTING WORK

You must make sure your truck is safe to use.

1. Walk around your truck and check it over.

- See that all wheels and tires are in good condition.
- Make sure all lights are working.
- Check that both forks are secure and not bent, cracked or badly worn.
- Inspect all lift chains for damage.
- Look under the truck for signs of fuel, oil, or coolant leaks.
- Inspect the seat belt for wear.
- Turn the key to TEST. Make certain the display warning alarm and all indicator lights are working.
- Test the horn.

For LPG Trucks

- Check for propane gas leaks. (Gas odor or frost on the cylinder or fuel valve).
- Check that fuel hoses are not cracked or worn.
- Inspect the fuel system and other parts for damage.
- Make certain the propane cylinder is properly installed and secure.

When raising the seat deck

Tilt the steering wheel up, remove the storage tray (if present), and move the seat and armrest towards the rear. Raise the seat deck to the open position. **Note:** A seat deck can fall. Make certain the gas struts are working properly and will hold the seat deck securely in the open position.

When using air-filled tires

- Check for missing lug nuts. Remove debris from the tire tread. Do not operate the truck if the tires are damaged.
- Check the tire pressure. Do not add air if the tire pressure is low. Report the problem to your supervisor.

2. Test drive your truck in an uncongested area.

- Fasten your seat belt.
- Adjust the operator seat and steering wheel to a comfortable position. Make sure that you can fully operate the controls.
- Try all the hydraulic functions.
- Check that the steering is easy and smooth.
- Check braking distance in forward and reverse. Load size and floor conditions can affect these distances.
- Drive the truck slowly in both directions.
- Drive through the full speed range in both forward and reverse.
- Know the distance it takes to stop before you start working. If the braking distance is too long to stop safely, don't drive the truck.

If anything doesn't look or feel right, don't drive the truck. Report the problem to your supervisor.

You can use the checklist form that came with your truck. Used properly, this checklist can alert service people to needed repairs.

Be a Safe Driver



The most important component is you.



MAKE SURE YOU ARE READY TO DRIVE

- Do not use this truck unless you are trained and certified.
- Make sure your hands and shoes are clean and dry, and your clothing is proper for the job.
- Be certain you understand how your truck works and the hazards that go with it. Don't drive the truck if you have any doubts.
- Know the capacity of your truck (Load Weight, Load Center and Lift Height). Make certain you use the correct units of measure.
- Some trucks are not allowed in areas where there are fire hazards. Be certain your truck is the correct fire safety type for the area.

MAKE SURE YOUR TRUCK IS READY

- Inspect your truck before using it. If it's not working right, or something is broken, report the problem to your supervisor. Don't use the truck.
- Be sure that any equipment added to the truck (terminal, fan, clipboard, etc.) is positioned so that it does not block your vision or interfere with safe and efficient operation of the truck.
- In an open area, test the braking. Check at a slow travel speed first, then a faster one. Know the distance it takes to stop before you start work.

WHEN LEAVING YOUR TRUCK

- Stop your truck completely before getting off.
- Lower the forks to the floor. Shut the truck off and apply the parking brake.
- Avoid parking on inclines. But if you must, block the wheels of your truck. Never park on a dockboard.

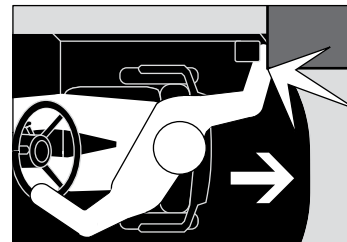
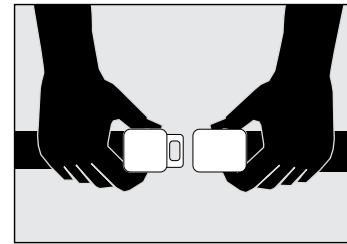

DRIVE CAUTIOUSLY, BE ALERT

- Fasten your seat belt and pull it snug.
- Never stick an arm or any part of your body outside the operator area, no matter how slow the truck is moving. A hand or foot caught between the truck and a fixed object will be crushed or even cut off.
- Keep your hands on the controls and your feet by the pedals.
- Travel in the direction that gives you the best view. Look where you are going and slow down in congested areas.
- Slow down for wet or slippery floors. Don't run over things.
- Travel with the forks close to the floor and mast tilted back. Place the load against the load backrest (vertical face of the forks).
- Look where you are going before you change direction of travel.
- See that you have room to drive and turn. Always check for overhead objects.
- Slow down when making turns.
- Avoid sudden movement of controls. Learn to use them smoothly at a moderate, even rate.
- Check clearances before raising or lowering the forks or load.
- Be extra careful if you must use your truck in an area where there is a risk of falling objects.

Continued next page...



WATCH OUT FOR OTHER PEOPLE

- Slow down. Yield or stop for pedestrians. Use your horn when you come to a crosswalk or intersection.
- Be careful that you don't pin or crush someone. *For example: Never drive your truck toward anyone standing in front of a fixed object.*
- Watch out for power unit swing.
- Never allow passengers on your truck.
- Keep others away from your truck while you're working. Don't ever allow anyone on or under the load or forks.
- Don't let anyone use your truck unless they are trained and certified.
- Never lift anyone with the forks unless they are using an approved platform. Even then use extreme caution:
 - Use a securely attached and approved safety platform.
 - Make certain lifting mechanism is operating properly.
 - Have load backrest vertical (never tilt when elevated).
 - Make certain truck is in neutral and brake is applied.
 - Lift and lower slowly.
 - Watch for overhead obstructions.
 - Be sure you can see and hear the person being lifted.
 - Never transport anyone on the platform from one location to another.

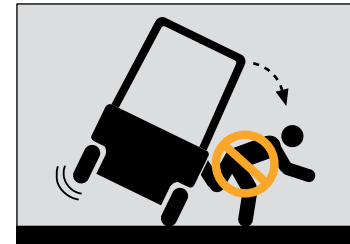
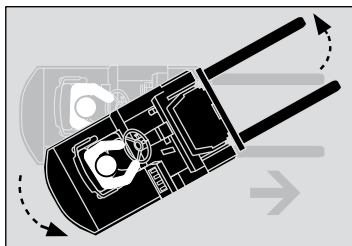

AVOID FALLS AND TIPOVERS

- Stay with your truck. Don't jump from a moving or falling sit-down, counterbalanced truck.
- Stay away from the edge of docks and ramps.
- Check that bridgeplates and dockboards are secure. Be certain that either the trailer wheels are chocked or the trailer is locked to the dock. Check capacities. Be sure your truck, with load, isn't too heavy for where you are driving.
- Make sure the load you are moving is stable. Spread the forks as far as you can and center the load. Insert forks as far under the load as you can. Be even more careful with long, tall, or wide loads. They can be less stable.
- Use forward tilt only when you have the load in a rack, over a stack or close to the floor. Use minimum fork tilt to pick up or place a load. When lifting or lowering outside a rack, keep the load backrest vertical or tilted back slightly.
- When moving loads on grades or ramps, drive with your forks pointed upgrade. Without a load, drive with forks downgrade. Slow down, and don't turn on grades or ramps.

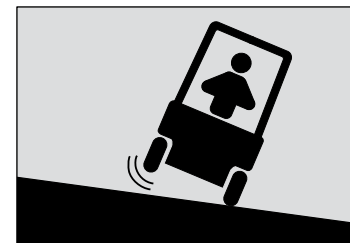

WHEN OPERATING OUTDOORS

- Slow down when traveling on slippery roads or slippery surfaces.
- Avoid traveling in areas which are flooded or where there are bumps, holes, or loose material that can cause the truck to tip or swerve.
- Do not drive your truck on soft ground, or on road shoulders which can be soft and may collapse.
- Stay away from curbs, rails, and ditches.
- When entering buildings, check floor weight limits.

Refueling, Propane (LPG)

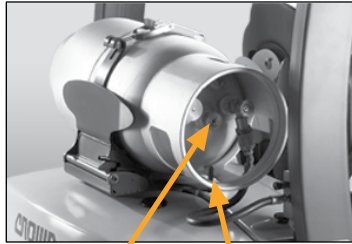

LOCATING PIN
FUEL SUPPLY VALVE

BEFORE YOU REMOVE THE LPG CYLINDER

1. Set the parking brake before leaving the truck.
2. While the engine is running, close the cylinder fuel supply valve (turn clockwise). After the engine stops running, turn the ignition switch OFF and disconnect the fuel hose from the cylinder.

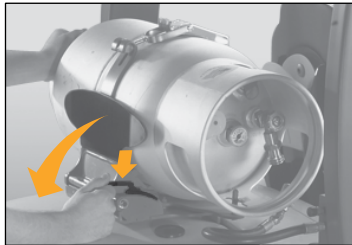

FOLD DOWN TANK MOUNT

1. Push down the release lever on the side of the fold down tank mount.
2. Grasp the tank firmly and carefully lower it to the down position.
3. Release the tank strap and remove the cylinder.

Caution: Do not operate the truck with the tank in lowered position.

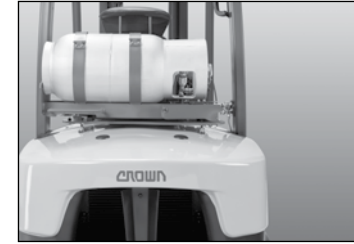

SWING OUT AND DOWN TANK MOUNT

1. Pull down the release lever. Pull the handle to swing out the tank. Make sure that the tank mount locks in the outward position.
2. Pull out the orange lock pin to lower the tank. Make sure that the tank mount locks in the fully lowered position.
3. Release the tank strap and remove the cylinder.

Caution: Do not operate the truck with the tank in lowered position.



Continued next page...

Refueling, Propane (LPG) continued

WHEN YOU INSTALL A LPG CYLINDER

1. Place correct size and type cylinder onto tank mount. Locating pin must fit through hole in cylinder collar.
2. Keeping your fingers clear, tighten the tank clamp. Return the tank mount to the upright position if your truck has that option. Make certain the tank and the mount are secure.
3. Attach the fuel hose to the cylinder and open the fuel supply valve SLOWLY to gradually equalize pressure and prevent the excess flow check valve from closing.
4. Check for leakage. If leakage is suspected, close the fuel supply valve and contact your supervisor.

Know the Hazards



! DANGER

Propane gas can cause a fire or even an explosion. Do not try to install, remove, refill or service a propane cylinder unless you are trained and authorized.

Never smoke or have an open flame around propane. See mounting bracket for allowable cylinder size. Locating pin must fit through hole in cylinder collar to maintain proper position.

If gas odor is detected or frost appears, turn off engine, close cylinder valve and contact supervisor or service department.

971-A

PROPANE CYLINDERS CAN BE DANGEROUS

Propane gas can cause a fire or even an explosion.

- Do not try to install, remove, refill or service your propane cylinder unless you are trained and authorized.
- Never smoke or use an open flame around propane.

- Your company should provide a ventilated area where it is safe to service and store propane cylinders.
- Disconnect the truck battery before servicing the fuel system.
- Wear proper personal protection equipment.
- Propane cylinders are heavy. Ask for help.
- Cylinders must not extend outside the truck.
- The fuel valve should be turned off when the truck is not in use.
- If a gas odor is detected, or frost is noticed on the cylinder or valve, turn the engine off and close the fuel supply valve. Contact your supervisor or service department.
- Use fuel manufactured to the National Gas Processors Association "HD-5" specification.
- Refueling of trucks with exchangeable or removable LP gas cylinders shall have the LP gas cylinder removed prior to refueling. Refueling shall be done in accordance with NFPA 58, 8.1.2.10 (ROP-28)
- Consult the National Fire Protection Association, Pamphlet 58, for additional information on safe handling and storage of propane (LPG).

Refueling, Diesel



Air-filled Tires



WHEN USING DIESEL FUEL

1. Lower the forks and put the truck in NEUTRAL.
2. Turn OFF the truck and apply the parking brake.
3. Remove the fuel cap and fill the fuel tank slowly. Do not fill the tank to the top.
4. Replace the fuel cap.

If fuel spills, wipe off any excess fuel and wash the area with water.

Note: Do not allow the truck to become low or run out of fuel. The truck may become difficult to start or damage the components.

Fill the fuel tank at the end of each shift to prevent condensation, corrosion, and fuel contamination.



WHEN USING AIR-FILLED TIRES

Before operating, check that the tires are properly inflated. The rated tire pressure is shown above the tire and on the tire data tag.

Check tire pressure from a position facing the tread of the tire. Use a long-handled gauge to keep your body away from the side of the tire.

Note: Do not add air if the tire pressure is low. You must be trained and authorized to inflate tires. Report the problem to your supervisor.



! Know the Hazards



WHEN REFUELING DIESEL FUEL TRUCKS

Diesel fuel can cause a fire or even an explosion.

- Your company should provide a ventilated area where it is safe to refuel the truck.
- Never smoke or use an open flame around diesel.
- Do not fill the tank to the top. Fuel expands when it gets warm and can overflow.

! Know the Hazards

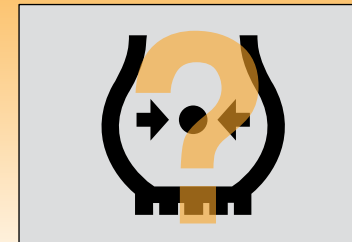

CHECK TIRE PRESSURE

Low tire pressure can reduce stability and cause a tip over.

- Check the tires for damage every time you check the tire pressure.
- Check the tire from a position facing the tread of the tire, not the side.
- Remove debris from the tire tread to prevent damage.
- Do not operate the truck if the tires are damaged or the tire pressure is low.

Notes

Warning Labels



EACH WARNING LABEL ON YOUR TRUCK IS IMPORTANT
Read and obey all of them to protect yourself and others.

⚠ DANGER

Flammable LP Gas
Severe injury by fire or even explosion is possible.
You must be trained before servicing LP trucks or cylinders. See service manual.

⚠ WARNING

Lifting people without a proper platform could cause a fall or other serious injury.
Platform must be built and used as specified in OSHA 1910.178 and ANSI-B56.1.

⚠ WARNING

Stay clear of all moving parts.
Moving parts can cut or crush hands, feet, arms or legs.

⚠ DANGER

Propane gas can cause a fire or even an explosion.
Do not try to install, remove, refill or service a propane cylinder unless you are trained and authorized.
Never smoke or have an open flame around propane. See mounting bracket for allowable cylinder size.
Locating pin must fit through hole in cylinder collar to maintain proper position.
If gas odor is detected or frost appears, turn off engine, close cylinder valve and contact supervisor or service department.

⚠ WARNING

Standing or riding on the forks can cause a fall. You can be seriously injured or killed.
Never stand or ride on forks for any reason.

⚠ WARNING

Falling objects or lowering forks can cause serious injury or death.
Never stand under the forks.
While servicing, block the forks so they won't fall.

⚠ WARNING

Passengers could be seriously injured. There is no safe place for them to ride.
No Passengers.

⚠ WARNING

Lifting people without a proper platform can cause a fall and serious injury.
Platform must be built and used as specified in OSHA 1910.178 and ANSI-B56.1.

⚠ WARNING

Unsupported loads can fall. The operator can be pinned or crushed.
Attached Load Backrest Extension if the load presents a hazard.

⚠ WARNING

Passengers could be seriously injured. There is no safe place for them to ride.
No Passengers.

⚠ WARNING

Tilting mast forward when forks are raised and loaded can tip the truck over causing injury or death.
Do not tilt elevated load forward unless it is over a stack.

⚠ DANGER

In case of tip-over
Follow these instructions:
Don't jump! **Hold on tight** **Brace feet**

⚠ WARNING

You can tip this truck over if you turn too sharply for the conditions around you. Don't risk injury or death.
Slow down when turning.

⚠ WARNING

Buckle seat belt

crown.com
All rights reserved under International and Pan American copyright conventions
Copyright 2008 Crown Equipment Corp.

C-5

C-5 SERIES

This operator manual has information for all models of series C-5 plus some options and accessories. Some of the illustrations and information may not apply to your truck.



The most important component is you.

CROWN

New Bremen, Ohio 45869 USA © 2009

600034 Rev. D

Printed in U.S.A.