

Operator Manual





WARNING

It's the law, you must be trained and certified to operate this truck. (OSHA § 1910.178, Rev. 1999)

You or others around you can be seriously injured or even killed if you don't use this truck correctly.

Read and obey all warnings and instructions in this Manual* and on the truck.

Head, arms, hands, legs or feet outside the operator area can be pinned or crushed whenever the truck is moving. Stay within the operator area and **stop the truck completely before getting off.**

However, tipovers and falls from docks can cause serious injury or even death. **Immediately exit and move away from the truck in these emergencies.**

You can be trapped or crushed by driving the operator area under racks or other objects. **Look where you are going.**

Inspect your truck before starting work, make sure it is in good working order.

* Additional copies of this Operator Manual and all Truck Labels can be obtained from Crown Equipment Corporation, New Bremen, Ohio 45869 U.S.A. www.crown.com

All rights reserved under International and Pan American copyright conventions
Copyright 2006-2021 Crown Equipment Corp.

You Must be Trained



IT'S THE LAW, YOU MUST BE TRAINED AND CERTIFIED

Federal law states that only properly trained operators are permitted to operate a powered industrial truck and that your employer must train you and certify that you are qualified to operate this powered industrial truck. (OSHA §1910.178, Rev. 1999)

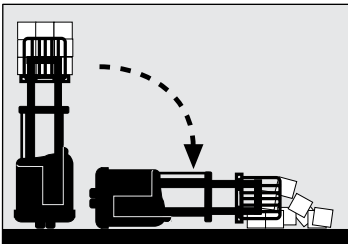

Do not operate this truck in your work place until you have been trained and certified by your employer.

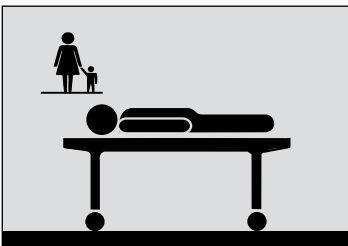

You could be killed or seriously injured if you are not adequately trained for lift truck operation!

Protect Yourself

Know the Hazards

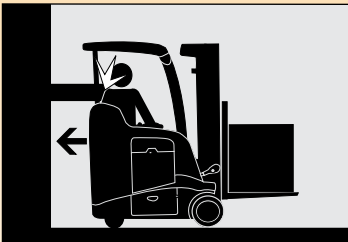
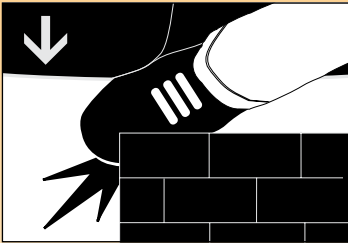
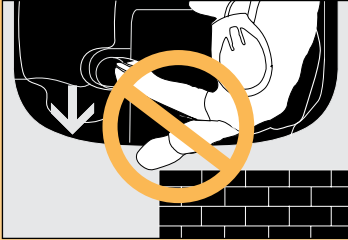

DRIVE CAREFULLY

- Keep your hands on the controls and feet on the pedals/pads. Keep your entire body in the operator area.
- Never stick a foot or any part of your body outside the operator area, no matter how slow the truck is moving. You cannot stop 3630 kg (8000 pounds) with any part of your body. A foot or hand caught between the truck and a fixed object will be crushed or even cut off.
- Stay away from the edge of docks and ramps. Make sure dockboards are secure. Check that trailer wheels are chocked. You could be seriously injured or even killed in a fall from a dock or dockboard.
- Keep your truck under control at all times. Drive at a speed that allows you to stop safely. Be even more careful on slippery or uneven surfaces. Do not drive over objects on the floor.
- Always be alert to the area around you and watch where you are driving. You could be pinned or crushed by objects intruding or poking into the operator area.



Know the Hazards

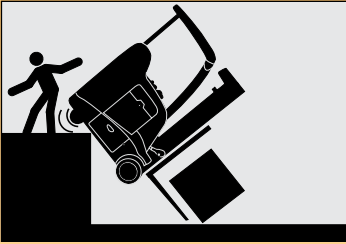

AVOID FALLS AND TIPOVERS

Falls from docks and tipovers are very serious accidents; you can be crushed or even killed. Immediately exit and move away from the truck in these emergencies. **Note:** This is not like sit-down, center control, counterbalanced trucks, where it is recommended that you stay with the truck. The best way to prevent injury is to know where you are at all times and follow the rules of safe truck operation.

- Be extremely careful when working around docks, dockboards and trailers.
- Use forward tilt only when you have the load over a stack or close to the floor.
- Travel with the load or forks close to the ground and tilted back. Watch for overhead obstructions. Perform all truck movements smoothly and at a speed that will give you time to react in an emergency.
- An unloaded truck can tip over also. Be just as careful using an unloaded truck as you are using a loaded one.

USE YOUR TRUCK SAFELY

- Keep your hands and feet away from all moving parts such as masts, chains, forks or wheels. Make sure the load backrest is in place.
- Never stand on or under the forks, or allow anyone else to stand on or under them. The only way to lift people is with an approved work platform. Never allow passengers on the truck. There is no safe place for them.
- Before you leave your truck:
 - Come to a complete stop and lower forks to the floor.
 - Shut the truck off with the key or Emergency Disconnect.

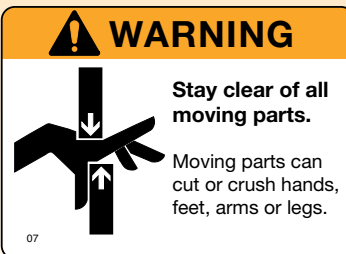

Contents

Warning	2
You Must be Trained	3
Protect Yourself	4
Contents	6
What's in it for You?	7
Your Stand-Up Rider	8
Lift Truck Parts	10
Capacity & Load Center	12
Capacity Plate	14
Power On & Off	16
Armrest & Floorboard Adjustment	17
Display	18
Foot Brake	20
Traveling & Plugging	22
Steering & Travel	24
Two Types of Steering	27
Fork Functions	28
Daily Safety Check	30
Be a Safe Driver	32
Power Sources	36
Charging Power Sources	37
Lithium-ion & Fuel Cell Power Packs	38
Flooded Lead Acid Batteries	40
Notes	42
Warning Labels	43

Capacity & Load Center

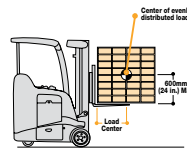

WHAT IS YOUR TRUCK CAPACITY?

Capacity is the load (including pallet, cart, container etc.) that can be lifted to a given height at a given load center. See the capacity plate on your truck. Make certain you use the correct units of measure.

WHAT IS LOAD CENTER?

Load center is the distance from the end of the operator platform to the center of an evenly distributed load.

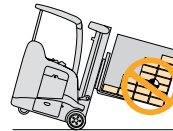

LOADS MUST BE EVENLY DISTRIBUTED

Your truck could tip over, in any direction, if a load is placed or shifted to the front side of a pallet or container.

SAMPLE

What's in it for You?

WHAT'S IN IT FOR YOU?

The better you understand your truck and how to use it, the better and safer operator you can be. Here are some guides to using this manual.

Know the Hazards

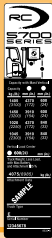

KNOW YOUR LOAD

Do not exceed the capacity shown on your truck's capacity plate. Be careful when handling long, high or wide loads. Do not handle unstable loads.

EXCEEDING TRUCK CAPACITY CAN CAUSE AN ACCIDENT

Know the capacity of your truck as shown on your capacity plate. Make certain you use the correct units of measure. Pay attention to:

- Weight of load
- Load center
- Lift height

HYDRAULIC OPERATIONS CAN AFFECT STABILITY

Capacities given on your capacity plate are for loads that are centered and level. Be extra careful when tilting a load. (This also applies to other accessories or attachments your truck may have, such as sideshift, carton clamp, push-pull, etc.)

CENTER THE LOAD

Your truck could tip over if a load is shifted to the front or side of a pallet or container. Make certain the load is evenly distributed and centered on the pallet or container.



Capacity & Load

QUICK LOCATORS

In addition to the "Contents" page you can use page headings to find topics. Some pages also have a picture of the truck in the corner showing features or functions covered on that page.

"KNOW THE HAZARDS"

Watch for and read these special blocks. You will find information about possible safety hazards and how to avoid them.

HOW-TO-DRAWINGS

On many pages you will find pictures as well as text to help you understand how to use your truck safely and productively.

Your Stand-Up Rider

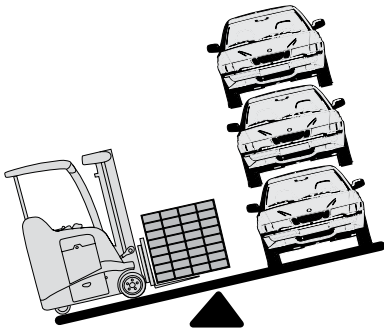

STAND-UP RIDERS

Your stand-up rider truck lifts, moves and stacks loads. It is designed for maneuverability in warehouses built with narrower aisles.

YOUR LIFT TRUCK IS NOT AN AUTOMOBILE

With a load it may weigh as much as 3 automobiles.

- You don't steer the same.
- You don't brake the same.
- You don't accelerate the same.

FORK FUNCTIONS, STANDARD AND OPTIONAL

Standard fork or hydraulic functions are: Raising and Lowering the forks plus Tilting the mast. Included may also be accessories like Sideshift, Carton Clamp, or Push-Pull. Your company has decided which features are needed in your work area and must train you how to use them.

HOW TO DRIVE YOUR TRUCK

Your truck may be equipped with padding in the operator area, along with an adjustable armrest and an adjustable floating floorboard. You drive your truck by standing sideways and leaning back into the pads. This, along with your hands on the controls and feet on the pedals, gives you both comfort and stability. Plus you can see and travel in either direction by turning your head.

GIVE YOUR BODY A BREAK

Take advantage of stop time. Get off the truck and flex your arms and legs. Staying alert will help you be a better and safer driver.

crown.com

Hands on Controls

Lean back against pad

Stand sideways

Foot On Brake Pedal/
Sensor Pad

BUILT TO STANDARDS

This truck was designed and built to current industry and government standards and guidelines. For more information see the following:

- American National Standards Institute (ANSI / ITSDF) B56.1 (Download free from www.itsdf.org)
- Occupational Safety and Health Act (OSHA) §1910.178, Rev. 1999 (Download free from osha.gov)
- Underwriters Laboratory (UL) 583
- National Fire Prevention Association (NFPA) 505

Lift Truck Parts

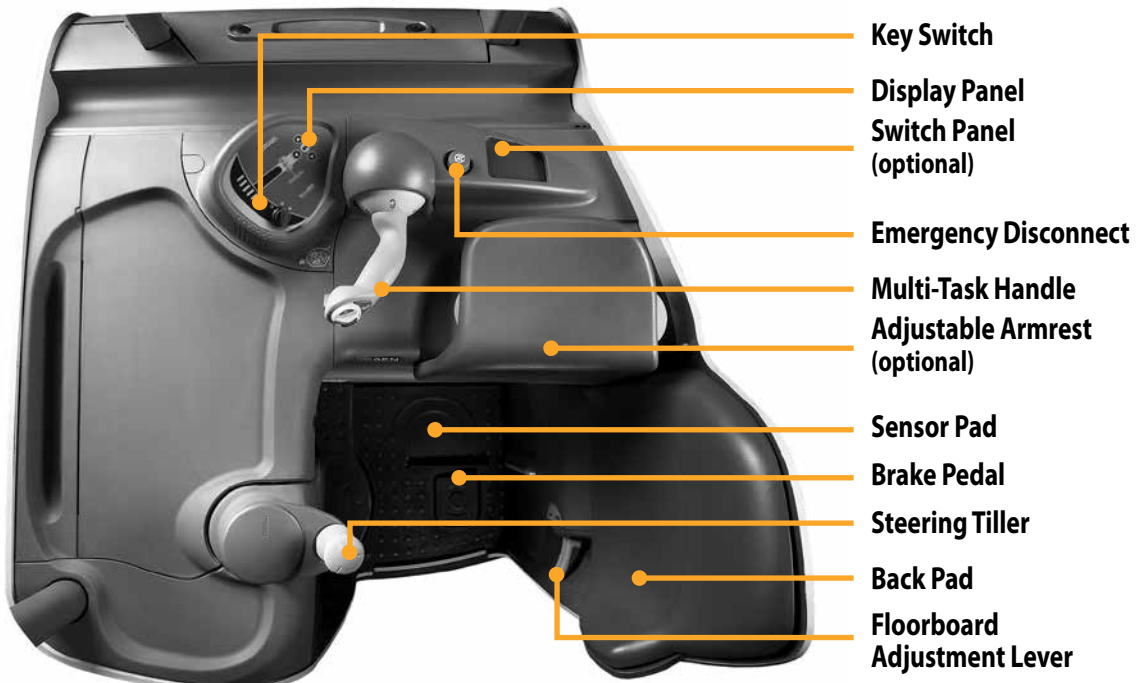

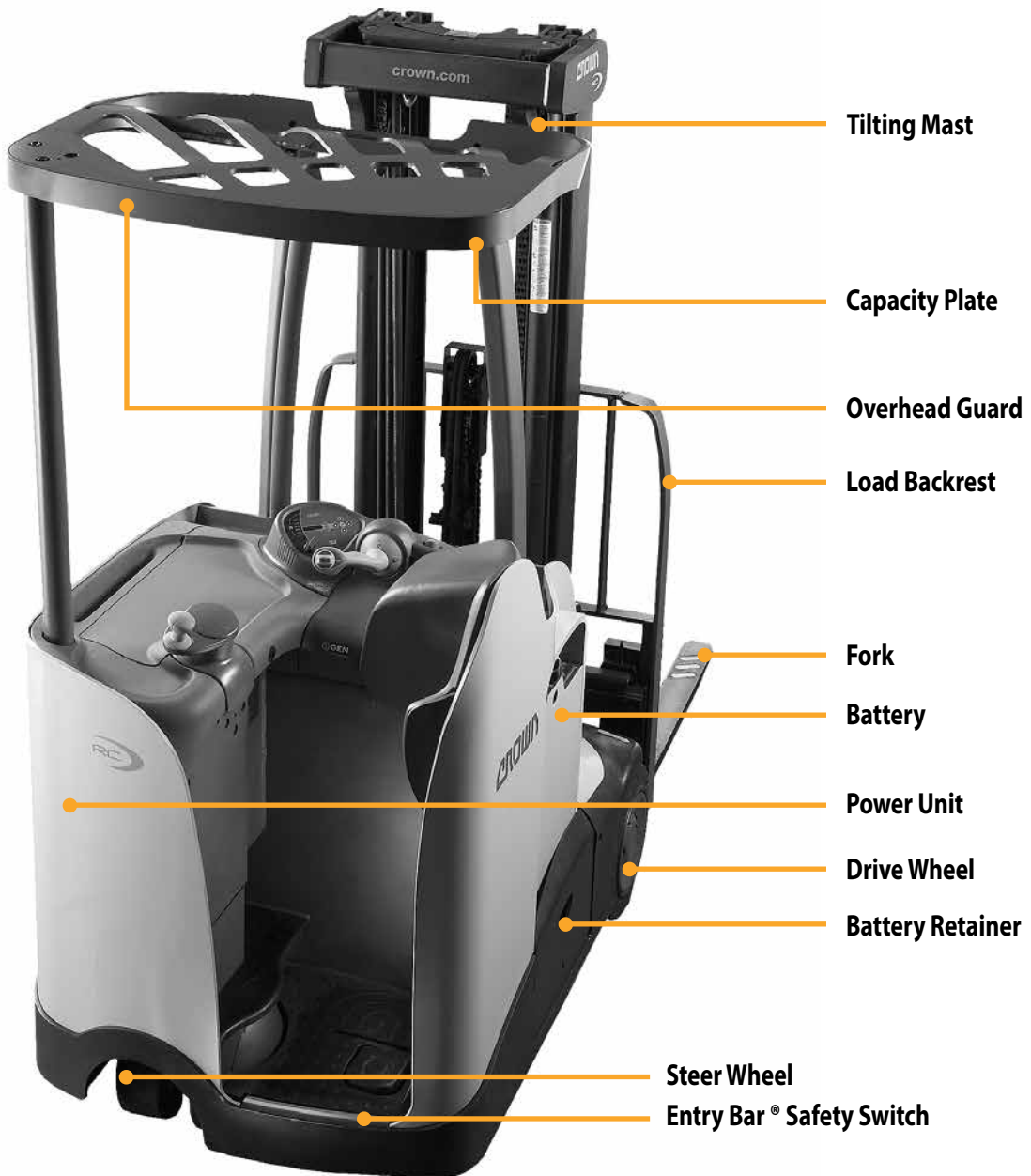

Tilting Mast

Capacity Plate

Overhead Guard

Load Backrest

Fork

Battery

Power Unit

Drive Wheel

Battery Retainer

Steer Wheel

Entry Bar® Safety Switch

Capacity & Load Center

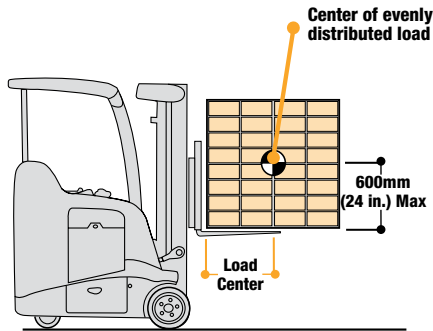

WHAT IS YOUR TRUCK CAPACITY?

Capacity is the load (including pallet, cart, container etc.) that can be lifted to a given height at a given load center. See the capacity plate on your truck. Make certain you use the correct units of measure.

WHAT IS LOAD CENTER?

The horizontal load center is the distance from the load backrest or vertical face of the fork to the center of an evenly distributed load.

Note: The load center can differ from the visible center position on the forks.

LOADS MUST BE EVENLY DISTRIBUTED

Your truck could tip over, in any direction, if a load is placed or shifted to the front side of a pallet or container.

LOAD POSITION CAN AFFECT STABILITY

Capacities shown on your capacity plate are with the mast vertical and load centered. Be extra careful when tilting a load or using sideshift. (This also applies to other accessories or attachments your truck may have, such as carton clamp, push-pull, etc.)

Make sure your load is centered before you raise, lower, or travel.

The forks should be at least two-thirds (67%) the length of the load. Crown recommends the forks be three-fourths (75%) the length of the load. Make sure the forks do not extend beyond the load.

Use minimum fork tilt to pick up or place a load.

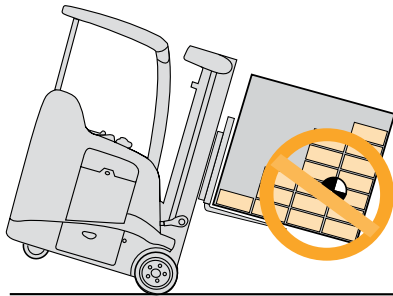



Know the Hazards

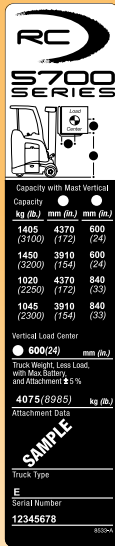

KNOW YOUR LOAD

Do not exceed the capacity shown on your truck's capacity plate. Be careful when handling long, high or wide loads. Do not handle unstable loads.

EXCEEDING TRUCK CAPACITY CAN CAUSE AN ACCIDENT

Know the capacity of your truck as shown on your capacity plate. Make certain you use the correct units of measure. Pay attention to:

- Weight of load
- Load center
- Lift height

HYDRAULIC OPERATIONS CAN AFFECT STABILITY

Capacities given on your capacity plate are for loads that are centered and level. Be extra careful when tilting a load. (This also applies to other accessories or attachments your truck may have, such as sideshift, carton clamp, push-pull, etc.)



CENTER THE LOAD

Your truck could tip over if a load is shifted to the front or side of a pallet or container. Make sure your load is evenly distributed and centered over the forks.

Capacity Plate



SAMPLE CAPACITY PLATE

The information shown on this sample plate does not apply to your truck.

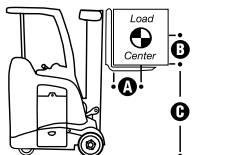
Capacity with Mast Vertical

Capacity	C	A
kg (lb)	mm (in)	mm (in)
1405 (3100)	4370 (172)	600 (24)
1450 (3200)	3910 (154)	600 (24)
1020 (2250)	4370 (172)	840 (33)
1045 (2300)	3910 (154)	840 (33)

Vertical Load Center
B **600(24)** mm (in)

Truck Weight, Less Load,
 with Max. Battery
 and Attachment \pm 5 %
4075(8985) kg (lb)

Attachment Data
SAMPLE

Truck Type

E
 Serial Number
12345678

8533-A

CAPACITY PLATE INFORMATION

The capacity plate is on the overhead guard post. It contains:

- Truck serial number
- Capacity information (load, load center and lift height)
- Truck type (a fire safety rating)
- Truck Weight, Less Load, with Max. Battery, and Attachments \pm 5%
- Attachment information (if any)

READING YOUR CAPACITY PLATE

Capacity may be reduced as lift height **C** increases. For example: On the sample plate, 1450kg (3200 lb) can be lifted to 3910mm (154 in). But above 3910 (154), to 4370 (172), capacity is reduced from 1450 (3200) to 1405 (3100).

Capacity is reduced as load center **A** increases. For example: On the sample plate, 1450kg (3200 lb) can be lifted if the load center is 600mm (24 in). But if the load center is increased to 840mm (33), capacity is reduced from 1450 (3200) to 1045 (2300).

Caution: You may not increase capacity if load center is less than shown on your capacity plate.

OTHER LIFT HEIGHT AND LOAD CENTERS

Contact Crown for capacities at lift heights or load centers not given on your capacity plate.



Know the Hazards

TRUCK WEIGHT

Dockboards, elevators and some floors have limited capacity. Check your capacity plate for the weight of your truck. Remember to add the weight of the load you have on the forks. Make certain you use the correct units of measure.

ATTACHMENT DATA

If an attachment on your truck does not match the information given here on your capacity plate, don't operate your truck. Your capacity plate may be wrong. Notify your supervisor.

TRUCK TYPE

Some truck types are not permitted in areas where there are fire hazards. Watch for marked areas. *For example: You must not drive a type E or ES truck into an area restricted to EE or EX trucks.*

Power On & Off



KEY SWITCH

- Turn the key clockwise to turn the truck ON.
- When leaving the truck, turn the key counterclockwise to shut the truck OFF.



FOOT PEDALS/ PADS

Place your left foot on the left brake pedal, and your right foot on the sensor pad. Turn the key ON and lift your left foot for a moment to cycle the brake. Return your foot to the pedal. Lift your right foot and return it to the pedal. Move the travel control and return it to center. The truck is ready for operation.



ENTRY BAR® SAFTEY SWITCH

Always keep your feet in the operator area and clear of the entry bar.

If you put your foot on the entry bar while traveling, the alarm will sound and the truck will slow to a stop.



EMERGENCY DISCONNECT

Push the Emergency Disconnect button to cut power to the truck.

Use the Emergency Disconnect to shut the truck down any time it isn't working correctly. Don't use the truck if it's not working correctly. Notify your supervisor.

Turn the key switch to OFF and back to ON to reconnect the battery and reset the Emergency Disconnect button.

Armrest & Floorboard Adjustment



ARMREST ADJUSTMENT (OPTIONAL)

Lift the orange latch at the rear of the armrest to release and raise the armrest.

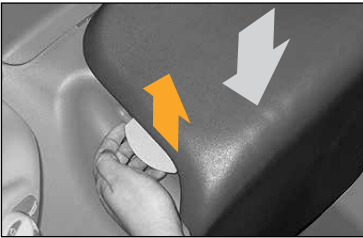

Lift the orange latch at the front of the armrest to release and lower the armrest.



FLOORBOARD ADJUSTMENT

Adjust the floating floorboard for the most comfortable ride for your weight.

Move the adjustment lever anywhere from the top position for the heaviest operator to the bottom position for the lightest operator.



POSTURE RELIEF STEP

Your truck is equipped with a posture relief step. Rest your foot on the posture relief step when the truck is not in operation. Both feet must be present on the pedals when the truck is in operation.

Display

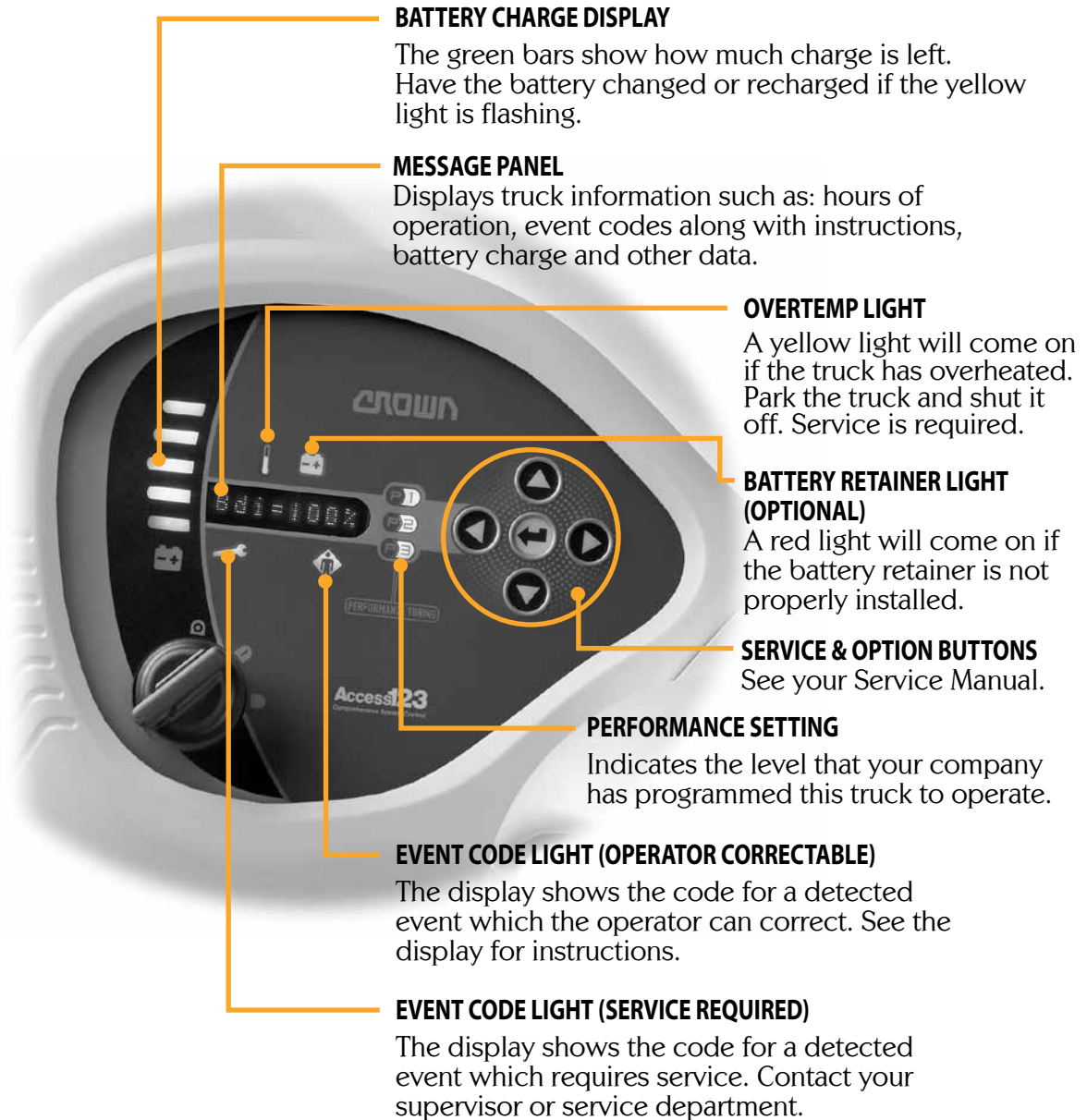

BATTERY CHARGE DISPLAY

The green bars show how much charge is left. Have the battery changed or recharged if the yellow light is flashing.

MESSAGE PANEL

Displays truck information such as: hours of operation, event codes along with instructions, battery charge and other data.

OVERTEMP LIGHT

A yellow light will come on if the truck has overheated. Park the truck and shut it off. Service is required.

BATTERY RETAINER LIGHT (OPTIONAL)

A red light will come on if the battery retainer is not properly installed.

SERVICE & OPTION BUTTONS
See your Service Manual.

PERFORMANCE SETTING

Indicates the level that your company has programmed this truck to operate.

EVENT CODE LIGHT (OPERATOR CORRECTABLE)

The display shows the code for a detected event which the operator can correct. See the display for instructions.

EVENT CODE LIGHT (SERVICE REQUIRED)

The display shows the code for a detected event which requires service. Contact your supervisor or service department.

This page
left blank
intentionally.

Foot Brake



BRAKE OFF

Step down on the brake pedal.
The service brake is now "off".



BRAKE ON

Lift your heel or move your foot off the brake pedal to
apply the service brakes. Keep a part of your foot in
contact with the floorboard.

Know the Hazards

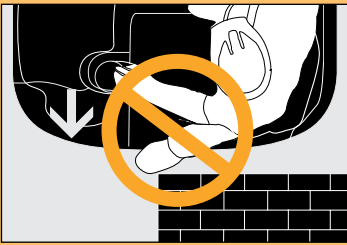

WATCH YOUR HANDS AND FEET

Keep your feet inside the truck and on the pedals at all times. This truck weighs about 3630kg (8000 pounds) even without a load. You cannot stop or even slow down that much weight with your foot or any part of your body, no matter how slow the truck is moving.

A foot or hand caught between the truck and a wall, post or any fixed object will be crushed or even cut off.

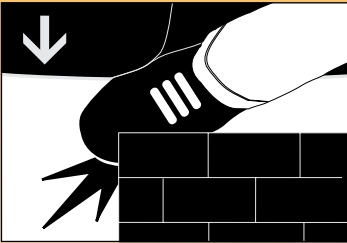

MAKE SURE YOUR BRAKES WORK

Test the brakes on your truck at the start of each shift. Know the distance it takes to stop before you start working.

If at any time the stopping distance is too long for you, do not drive your truck. Notify your supervisor.

Traveling & Plugging



TRAVEL, POWER UNIT FIRST

Pull the multi-task handle toward you to travel in the direction of the power unit (power unit first).

The farther you pull the handle from the neutral position, the faster the truck will travel.



TRAVEL, FORKS FIRST

Push the multi-task handle away from you to travel in the direction of the forks (forks first).

The farther you push the handle from the neutral position, the faster the truck will travel.



PLUGGING

Plugging is another way to slow down or stop your truck.

While the truck is moving, in either direction, pull or push the multi-task handle through neutral to the opposite direction of travel.

This will not hurt your truck.

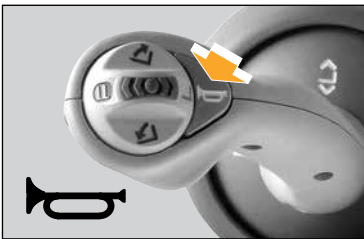
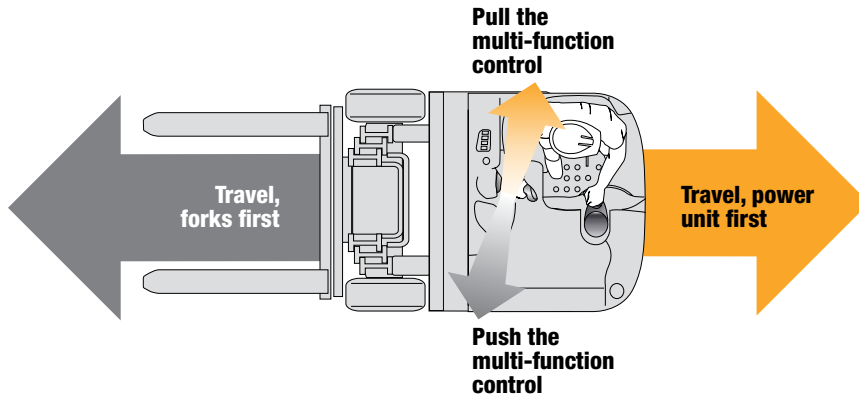

HORN

Press the button on the multi-task handle to sound the horn. Use it to warn pedestrians and other drivers. Use your horn when you come to an intersection or a crosswalk.

! Know the Hazards

LOOK WHERE YOU'RE GOING

Driver distractions can cause accidents resulting in injury or even death.

- Don't use cell phones or similar devices while operating the truck.
- Travel in the direction where you have the best visibility.

PLUGGING VS. BRAKING

Of the two, the foot brake is designed to stop the truck in the shortest distance. Use the foot brake in an emergency, on ramps or in busy areas.

Steering & Travel



STEERING AND DRIVING

You will need to drive your truck in both the direction of the forks (forks first) and also in the direction of the power unit (power unit first or forks trailing). Steering is not the same in both directions. Be careful. Drive slowly until you get used to all the controls.



TRUCKS THAT LOOK ALIKE CAN BE DIFFERENT

This style truck can be built with one of two different types of steering. Your company has selected the type which is best for your work area.

Caution: If you ever drive a different RC Series truck, be careful. The steering may be different (see page 27).



Know the Hazards

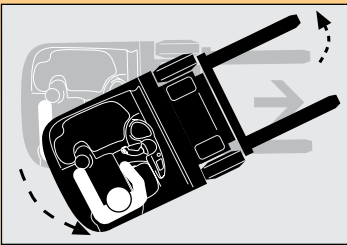

POWER UNIT SWING

Be careful turning while traveling forks first. The power unit will swing wide in the opposite direction. Make sure you have clearance, and watch out for people in the area.

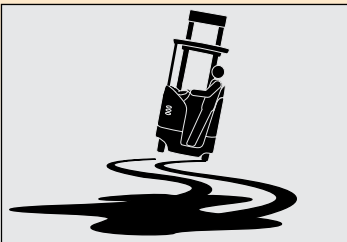

SLOW DOWN FOR SPILLS OR WET FLOORS

Powder or liquid spills can cause slippery floors. Slow down or you could lose control of steering and braking. Be careful and allow for a longer stopping distance.

Don't run over objects on the floor.

This page
left blank
intentionally.

Two Types of Steering

- 1 REAR DIRECTIONAL STEERING (Sometimes called Reverse Steering.)**
Shows direction truck will turn when steering handle is turned clockwise.

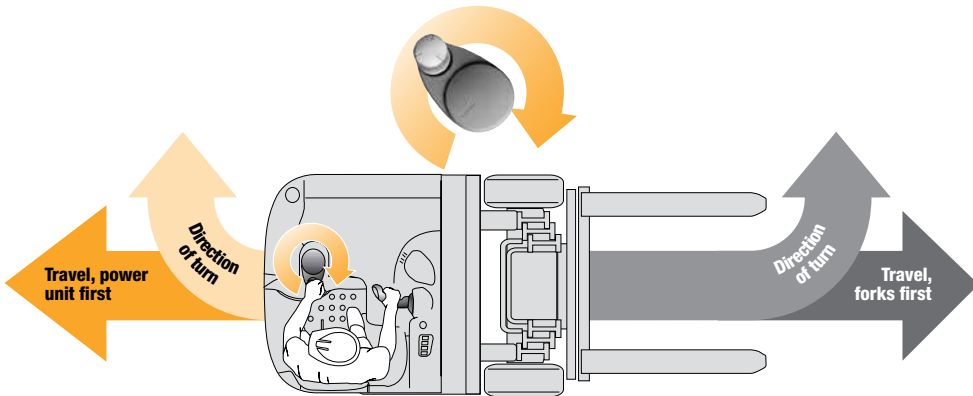

- 2 FRONT DIRECTIONAL STEERING (Sometimes called Forward Steering.)**
Shows direction truck will turn when steering handle is turned clockwise.

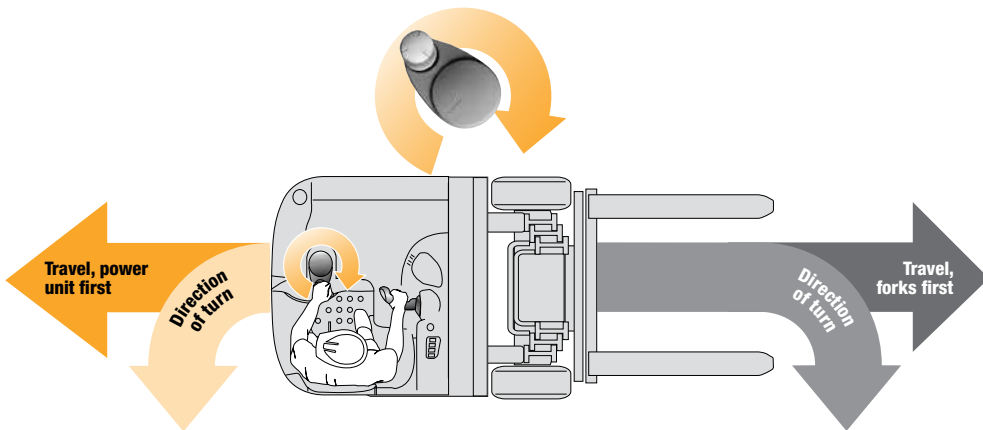

Fork Functions



FORK FUNCTIONS

Standard fork functions include Raising and Lowering the forks, and Tilt (up and down).



RAISE/LOWER



Lift the multi-task handle up to raise the forks. Push down on the handle to lower the forks.

The farther you move the multi-task handle from neutral, the faster the forks will move.

FORK TIP POSITION WILL VARY DEPENDING ON LOAD

The height of the fork tips and angle of the forks will change depending on how much load is on the forks. Always check to see that the forks are at the correct lift height and tilt position to enter a pallet, and that the pallet and load will clear the rack beams.

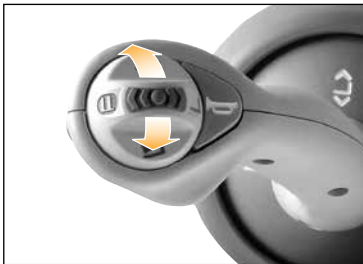

THUMB BALL

All hydraulic fork functions, other than raise & lower, are controlled by the multi-task thumb ball.

TILT UP & DOWN



Roll the thumb ball up to tilt the fork tips up. Roll the ball down to tilt the fork tips down.

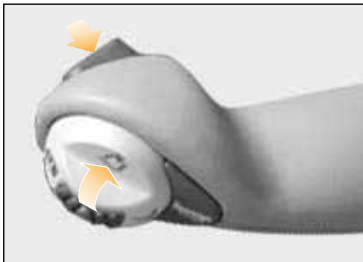

TILT POSITION ASSIST™ OPTION



With the thumb ball in neutral, press and hold the switch on the back of the multi-task handle. Then roll the thumb ball either up or down.

If your truck is equipped with this option, the forks will go to the programmed tilt position chosen by your company for this truck.

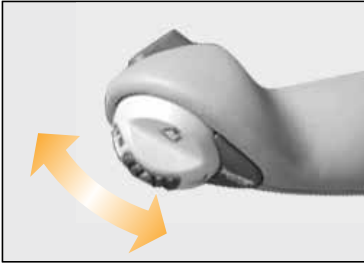

SIDESHIFT OPTION

Roll the ball away from you to shift the forks to the left (away from you). Roll the ball toward you to shift the forks to the right (toward you). The farther you move the ball from neutral the faster the forks will move.

SECOND HYDRAULIC OPTION

Hold the gray button on the back of the handle and roll the ball toward you or away from you.

Know the Hazards

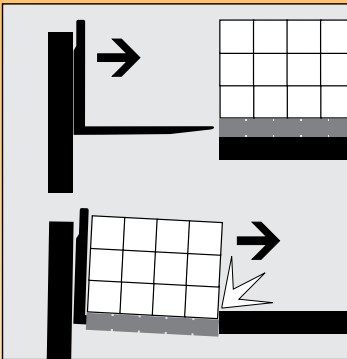

FORK POSITION WILL VARY DEPENDING ON LOAD

The tilt of the fork tips and raised height of the forks will change depending on how much load is on the forks.

Always check to see that the forks are at the correct tilt position and lift height to enter a pallet, and that the pallet and load will clear the rack beams.

Use minimum fork tilt to pick up or place a load. When raising or lowering outside a rack, keep the load backrest vertical or tilted back slightly.

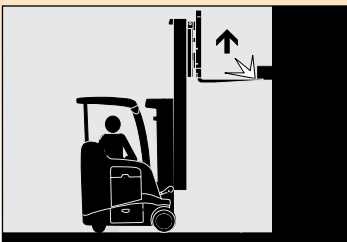

CHECK THE PATH OF THE FORKS

Make certain the path of the forks is clear and free of obstacles.

Check that the forks are at the proper position to enter the pallet, or that the pallet will clear the rack beam.

Daily Safety Check



CHECK YOUR TRUCK BEFORE STARTING WORK

You must make sure your truck is safe to use.

1. Walk around your truck and check it over.

- Check the battery connector, battery terminals, and battery cables for damage.

For flooded lead acid batteries:

- Check the battery compartment for spilled acid.
- After checking the water level, make sure that the vent caps are in place.
- Make certain the battery retainers on both sides of the truck are properly installed.
- See that all wheels are in good condition.
- Check that both forks are secure and not bent, cracked or badly worn.
- Inspect lift chains and anchors for damage and corrosion. Make sure that the lift chains are well lubricated.
- See that the load backrest is in place.
- Look under the truck for signs of hydraulic leaks.
- Test the horn.
- Make sure the emergency disconnect works.

2. Test drive your truck in an uncongested area.

- Try the hydraulic functions.
- Check that the steering is easy and smooth.
- Drive the truck slowly in both directions.
- Drive through the full speed range in both forward and reverse.
- Check braking and plugging distances in forward and reverse. Load size and floor conditions can affect these distances.
- Know the distance it takes to stop before you start working. If the braking distance is too long for you, do not drive your truck. Notify your supervisor.

If anything doesn't look, work, feel or sound right, do not operate your truck. Notify your supervisor.

You can get checklist forms from your Crown dealer (part no. OF-3772). Used properly, this checklist can alert service people to needed repairs.

Be a Safe Driver



*The most
important
component
is you.*

MAKE SURE YOU ARE READY TO DRIVE

- Do not use this truck unless you are trained and certified.
- Be certain you understand how your truck works and the hazards that go with it. Don't drive the truck if you have any doubts.
- Know the capacity of your truck. (Load Weight, Load Center and Lift Height). Make certain you use the correct units of measure.
- Some trucks are not allowed in areas where there are fire hazards. Be certain your truck is the correct fire safety type for the area.
- Make sure your hands and shoes are clean and dry, and your clothing is proper for the job.



MAKE SURE YOUR TRUCK IS READY

- Inspect your truck before using it (see pages 30 and 31). If it's not working correctly, or something is broken, don't use your truck. Notify your supervisor.
- In an open area, test the braking and plugging. Check at a slow travel speed first, then a faster one. Know the distance it takes to stop before you start work.

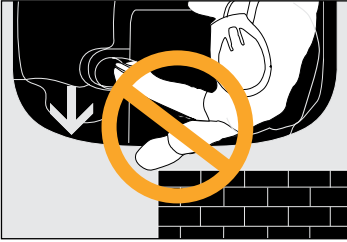

DRIVE CAUTIOUSLY, BE ALERT

- Never stick a foot or any part of your body outside the operator area, no matter how slow the truck is moving. You cannot stop 3630 kg (8000 pounds) with any part of your body. A foot or hand caught between the truck and a fixed object will be crushed or even cut off.
- Keep your hands on the controls and your feet on the pedals.
- Travel in the direction that gives you the best view. Look where you are going and slow down in congested areas.
- Slow down for wet or slippery floors. Don't run over things.
- Travel with the forks close to the ground, retracted and tilted up. Place the load against the load backrest (vertical face of the forks).
- Look where you are going before you change direction of travel.
- See that you have room to drive and turn. Always check for overhead objects. Watch out for power unit swing.
- Slow down when making turns.
- Avoid sudden movement of controls. Learn to use them smoothly at a moderate, even rate.
- Check clearances before raising or lowering the forks or load.
- Be extra careful if you must use your truck in an area where there is a risk of falling objects.

Continued next page...

Be a Safe Driver continued

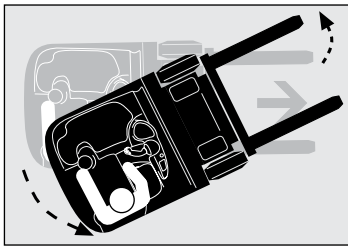
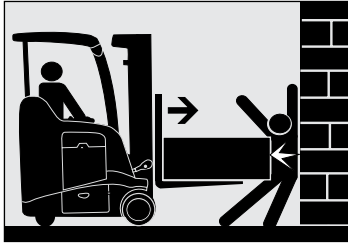

WATCH OUT FOR OTHER PEOPLE

- Slow down. Yield or stop for pedestrians. Use your horn when you come to a crosswalk or intersection.
- Be careful that you don't pin or crush someone. *For example: Never drive your truck toward anyone standing in front of a fixed object.*
- Never allow passengers on your truck.
- Watch out for power unit swing.
- Keep others away from your truck while you're working. Don't ever allow anyone on or under the load or forks.
- Don't let anyone use your truck unless they are trained and certified.
- Never lift anyone with the forks unless they are using an approved work platform. Even then use extreme caution:
 - Use a securely attached and approved work platform.
 - Make certain lifting mechanism is operating properly.
 - Have load backrest vertical (never tilt when elevated).
 - Make certain truck is in neutral and brake is applied.
 - Lift and lower slowly.
 - Watch for overhead obstructions.
 - Be sure you can see and hear the person being lifted.
- Never transport anyone on the work platform from one location to another.

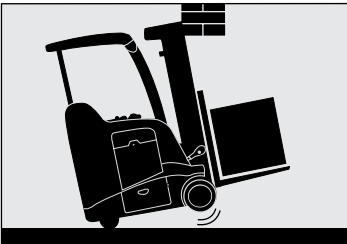
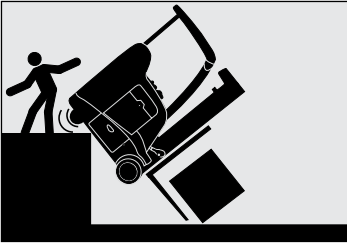

AVOID FALLS AND TIPOVERS

- Stay away from the edge of docks and ramps.
- Check that bridgeplates and dockboards are secure. Be certain that either the trailer wheels are chocked or the trailer is locked to the dock. Check capacities. Be sure your truck, with load, isn't too heavy for where you are driving.
- Properly install jack stands under the front of the trailer when a tractor is not attached.
- Make sure the load you are moving is stable. Spread the forks as far as you can and center the load. Insert the forks as far under the load as you can. Be even more careful with long, high or wide loads. They can be less stable.
- Use forward tilt only when you have the load over a stack or close to the floor. Use minimum fork tilt to pick up or place a load. When lifting or lowering outside a rack, keep the load backrest vertical or tilted back slightly.
- When moving loads on grades or ramps, drive with your forks pointed up grade. Without a load, drive with forks down grade. Slow down, and don't turn on grades or ramps.

LEAVING YOUR TRUCK

- Stop your truck completely before getting off.
- Lower the forks to the floor. Turn the truck off or disconnect the battery.
- Avoid parking on inclines. If you must park on an incline, chock the wheels to prevent the truck from moving.

Power Sources

POWER SOURCES

Your truck can be designed to use the following power sources:

- Flooded Lead Acid Batteries
- Thin Plate Pure Lead Acid Batteries
- Lithium-Ion Batteries
- Fuel Cell Power Packs

If your truck is equipped with a V-Force lithium-ion battery, see the data plate installed on your truck.

Only Crown approved power sources are permitted to be used in your truck. Only authorized service personnel are permitted to modify the power source installed in your truck.

See the power source data plate for the approved power source installed in your truck.

Note: Follow the manufacturer's specification and instructions when handling power sources.

WORKING WITH POWER SOURCES

Your company should provide an area that is safe to work on power sources. Use that area for all power source work and charging.

- Do not charge or refuel a power source unless you are trained and authorized.
- Do not remove or install a power source unless you are trained and authorized.

Charging Power Sources

BEFORE CHARGING POWER SOURCES

- Read the instructions for the charger and power source.
- Make sure that the charger has the correct voltage and amperage for the power source.
- Only charge a power source in an authorized area.

CHARGING A FLOODED LEAD ACID BATTERY

1. Turn off your truck.
2. Unplug the power source connector from the truck.
3. Follow the charging instructions from the power source manufacturer.

When charging is complete, unplug the charger and plug the power source connector into the truck.

CHARGING A V-FORCE® LITHIUM-ION BATTERY

1. Turn off your truck.
2. Plug the charger into the battery charge port.
3. Follow the charging instructions for the V-Force lithium-ion battery.

Opportunity charge during breaks or whenever the truck is not being used.

When opportunity charging is complete or the battery is fully charged, unplug the charger from the battery charge port.



Know the Hazards

AVOID DAMAGING THE TRUCK AND BATTERY CHARGER

Make sure that the battery charger is plugged into the battery connector, not the truck connector.

AVOID DAMAGING THE BATTERY

Batteries that are not properly maintained will fail prematurely.

Always follow the battery manufacturer's instructions.

Lithium-ion & Fuel Cell Power Packs

LITHIUM-ION BATTERIES AND FUEL CELL POWER PACKS

For trucks equipped with a V-Force lithium-ion battery, the energy status is shown on the truck display.

Trucks qualified and approved to operate with another lithium-ion battery or fuel cell power pack can have a separate display. Use the display installed on the battery to see the energy status.



Know the Hazards

AVOID DAMAGING THE POWER SOURCE

Do not operate trucks with lithium-ion batteries in freezing temperatures. Do not leave trucks in freezing temperatures.

Always follow the battery manufacturer's instructions.

This page left
blank
intentionally

Flooded Lead Acid Batteries

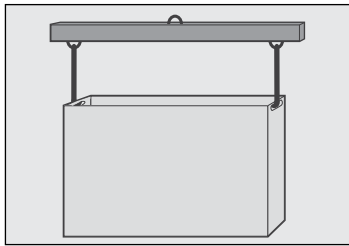
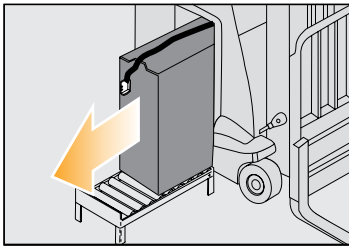
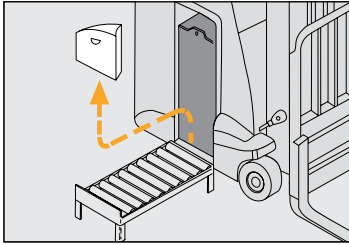

WHEN YOU INSTALL OR CHANGE BATTERIES

- Turn the truck OFF. Check that all controls are in neutral.
- Make certain you use the correct size and weight battery. Never operate a truck that has an underweight or undersize battery installed.
- Use a roller stand to install or remove a battery. Make sure the roller stand is the same height as the rollers in the truck's battery compartment. Also make sure the roller stand is at least as long as your battery.
- Never let anything metal touch the top of the cells. You could cause sparks or do damage to the battery. Use an insulator (such as plywood) when necessary.
- Use an approved spreader bar to place a battery on, or remove it from a stand. Make sure you adjust the spreader bar hooks to fit the battery. Lift and move the battery carefully.



Know the Hazards

WARNING

Minimum battery size allowed
XXX mm (00.00 in.) wide
XXX mm (00.00 in.) long

Undersize battery can affect truck handling and stability. You could have an accident.

Use U.L. classified Type E battery.

BATTERY SIZE

- Make certain you use the correct size and weight battery. Never operate a truck that has an underweight or undersized battery installed.

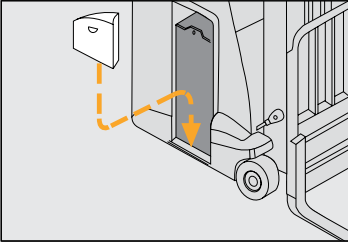

AFTER INSTALLING YOUR BATTERY

- Replace the battery retainers. Make certain the retainers on both sides of the truck are in place.
- Check that the battery retainers are properly adjusted to prevent the battery from shifting.
- Connect the battery. Turn the truck ON and check truck operation.



Know the Hazards

BATTERY RETAINERS

- The battery could slide out if retainers are not in place. Check both sides of the truck.
- Truck operation can be affected if the battery is able to shift. Make certain the battery retainers are properly adjusted.



DANGER



Batteries produce explosive gas. Do not smoke, use open flame, or create an arc or sparks near this battery. Ventilate well in enclosed areas and when charging.

Batteries contain **Sulfuric Acid** which causes severe burns. Do not get in eyes, on skin, or clothing. In case of contact, flush immediately. Get medical attention if your eyes are affected.

107

TRUCK BATTERIES CAN BE DANGEROUS

Lead acid batteries produce gas that can explode. It also contains acid that could burn or disfigure you.

- Do not try to install, remove, charge or service your truck battery unless you are trained and authorized.
- Never smoke or use an open flame around batteries.
- Your company should provide an area where it is safe to work on batteries. Use that area for all battery work.
- Use protective equipment such as gloves, eye shields, aprons etc.

Warning Labels



EACH WARNING LABEL ON YOU TRUCK IS IMPORTANT

Read and obey all of them to protect yourself and others.

WARNING

Operate this truck only with an approved electric power source.

This truck as designed and manufactured from the factory is qualified for use with a lead acid battery and if configured, Crown V-Force products.

Written approval must be obtained from Crown prior to installation of a new type of electric power source. OSHA 1910.178 (a)

809E-A

WARNING

Unsupported loads can fall.
The operator can be pinned or crushed.

Attach Load Backrest Extension if the load presents a hazard.

091-B

WARNING

Minimum battery size allowed
000 mm (00.00 in.) wide
000 mm (00.00 in.) long

Undersize battery can affect truck handling and stability. You could have an accident.

Use U.L. classified Type E battery

WARNING

Protect yourself.

Keep these inside!

Remember your training!

This truck can weigh as much as 3 automobiles. You cannot stop that much weight with a foot or hand.

765-A

WARNING

Standing or riding on the forks can cause a fall. You can be seriously injured or killed.

Never stand or ride on forks for any reason.

05

WARNING

Falling objects or lowering forks can cause serious injury or death.

Never stand under the forks.

While servicing, block the forks so they won't fall.

05

DANGER

Batteries produce explosive gas. Do not smoke, use open flame, or create an arc or sparks near this battery. Ventilate well in enclosed areas and when charging.

Batteries contain Sulfuric Acid which causes severe burns. Do not get in eyes, on skin, or clothing. In case of contact, flush immediately. Get medical attention if your eyes are affected.

107

WARNING

Not a step

611

CAUTION

Connect charger properly or truck can be damaged.

Make certain charger is plugged into the battery connector, not the truck connector.

17

WARNING

06

WARNING

STOP

It's the law, you must be trained and certified to operate this truck.

(OSHA § 1910.178, Rev. 1999)

You or people around you could be seriously injured or even killed if you don't use this truck correctly.

Obey all instructions & warnings in the operator manual and on the truck.

Avoid being crushed.
Keep head, arms, hands, legs, and feet within the operator area. **Stop truck completely before getting off.**

However, tipovers and falls from docks can cause serious injury or even death. Immediately exit and move away from the truck in these emergencies.

You can be trapped or crushed by driving the operator area under racks or other objects. **Look where you are going.**

Inspect your truck before starting work, make sure it's in good working order.

* Additional copies of the Operators Manual and Truck Labels can be obtained from: Crown Equipment Corp.,

crown.com 627-D

WARNING

Stay clear of all moving parts.

Moving parts can cut or crush hands, feet, arms or legs.

WARNING

Tilting mast forward when forks are raised and loaded can tip the truck over causing injury or death

Do not tilt elevated load forward unless it is over a stack

WARNING

Passengers could be seriously injured. There is no safe place for them to ride.

No Passengers.

WARNING

Lifting people without a proper platform can cause a fall and serious injury.

Platform must be built and used as specified in OSHA 1910.178 and ANSI/ITSDF B56.1. 655-C



5700 SERIES



This operator manual has information for all models of series RC 5700 plus some options and accessories. Some of the illustrations and information may not apply to your truck.

The most important component is you.

