

Operator Manual



Power Steer



WARNING

It's the law, you must be trained and certified to operate this truck.

(OSHA § 1910.178, Rev. 1999)

You or others around you can be seriously injured or even killed if you don't use this truck correctly.

Read and obey all warnings and instructions in this Manual* and on the truck.

Head, arms, hands, legs or feet outside the operator area can be pinned or crushed whenever the truck is moving. Stay within the operator area and **stop the truck completely before getting on or off.**

A dockboard can move or drop while you are on it. Or you could drive off a dock. Falls from docks or dockboards can cause serious injury or even death. **Make sure you are safe.**

Inspect your truck before starting work, make sure it is in good working order.

* Additional copies of this Operator Manual and all Truck Labels can be obtained from Crown Equipment Corporation, New Bremen, Ohio 45869 U.S.A.
www.crown.com

All rights reserved under International
and Pan American copyright conventions
Copyright 2008-2021 Crown Equipment Corp.

You Must be Trained



IT'S THE LAW, YOU MUST BE TRAINED AND CERTIFIED

Federal law states that only properly trained operators are permitted to operate a powered industrial truck and that your employer must train you and certify that you are qualified to operate this powered industrial truck. (OSHA §1910.178, Rev. 1999)



Do not operate this truck in your work place until you have been trained and certified by your employer.

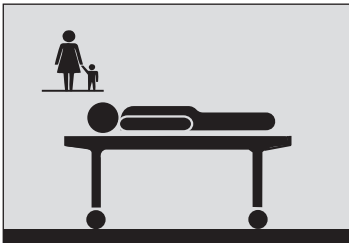

You could be killed or seriously injured if you are not adequately trained for lift truck operation!

Protect Yourself

! Know the Hazards

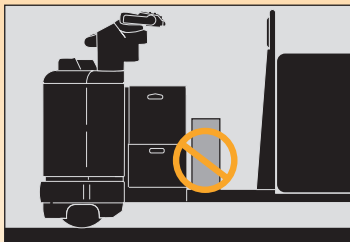
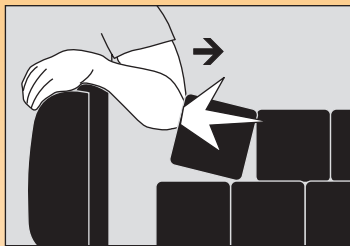

DRIVE CAREFULLY

- When allowing the truck to coast, travel power unit first only. Do not turn. Keep to the side of the truck. Make certain the truck or load won't hit your leg or foot. Don't let the truck run over your foot.
- When riding, keep your hands on the controls and feet on the platform. Keep your body within the operator area.
- Don't put hands or arms over or through the backrest.
- Never stick a foot or any part of your body outside the truck, no matter how slow the truck is moving. You can not stop 4535 kg (10,000 lbs) with any part of your body. A foot or hand caught between the truck and a fixed object will be crushed or even cut off.
- Never place objects anywhere on the operator platform. They would be a trip hazard and could affect truck speed and steering.
- Stay away from the edge of docks and ramps. Make sure dockboards are secure. Check that trailer wheels are chocked. You could be seriously injured or even killed in a fall from a dock or dockboard.
- Keep your truck under control at all times. Drive at a speed that allows you to stop safely. Be even more careful on slippery or uneven surfaces. Do not drive over objects on the floor.
- Perform all truck movements smoothly and at a speed that will give you time to react in an emergency.

Know the Hazards



LOOK WHERE YOU'RE DRIVING

Always be alert to the area around you and watch where you are driving. You could be pinned or crushed by fixed objects, or by objects intruding or poking into the operator area.

When allowing the truck to coast, make certain the area ahead of you is clear.

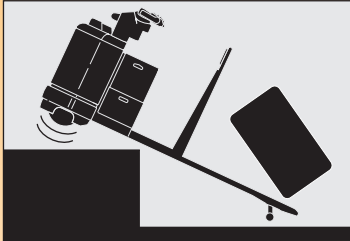

AVOID FALLS

Falls are very serious accidents, you can be crushed or even killed. The best way to prevent injury is to know where you are at all times and follow the rules of safe truck operation. Unless you can safely jump completely clear of the falling truck, there is no sure way to avoid injury if you drop from a dock or dockboard.

Be extremely careful when working around docks, dockboards and trailers.



USE YOUR TRUCK SAFELY

- Keep your hands and feet away from all moving parts such as forks and wheels.
- Never allow passengers anywhere on the truck. There is no safe place for them.
- Before you leave your truck:
 - Come to a complete stop.
 - Lower the forks to the floor.
 - Shut the truck off with the key or disconnect the battery.

Contents

Warning	2
You Must be Trained	3
Protect Yourself	4
Contents	6
What's in it for You?	7
Your Rider Pallet Truck	8
Pallet Truck Parts	10
Capacity Plate	12
Display	14
Power On & Off	15
Steering & Travel	16
Coasting	18
Braking	20
Raising & Lowering	21
Traveling & Plugging	22
QuickPick®	24
Additional Options	31
Daily Safety Check	32
Be a Safe Driver	34
Power Sources	38
Charging Power Sources	39
Lithium-ion & Fuel Cell Power Packs	40
Flooded Lead Acid Batteries	42
Notes	46
Warning Labels	47

Flooded Lead Acid Batteries



[Redacted text block]



[Redacted text block]

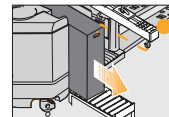

[Redacted text block]

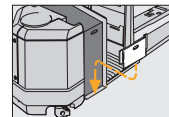

[Redacted text block]

What's in it for You?

WHAT'S IN IT FOR YOU?

The better you understand your truck and how to use it, the better and safer operator you can be. Here are some guides to using this manual.

QUICK LOCATORS

In addition to the "Contents" page you can use page headings to find topics. Some pages also have a picture of the truck in the corner showing features or functions covered on that page.

"KNOW THE HAZARDS"

Watch for and read these special blocks. You will find information about possible safety hazards and how to avoid them.

HOW-TO-DRAWINGS

On many pages you will find pictures as well as text to help you understand how to use your truck safely and productively.

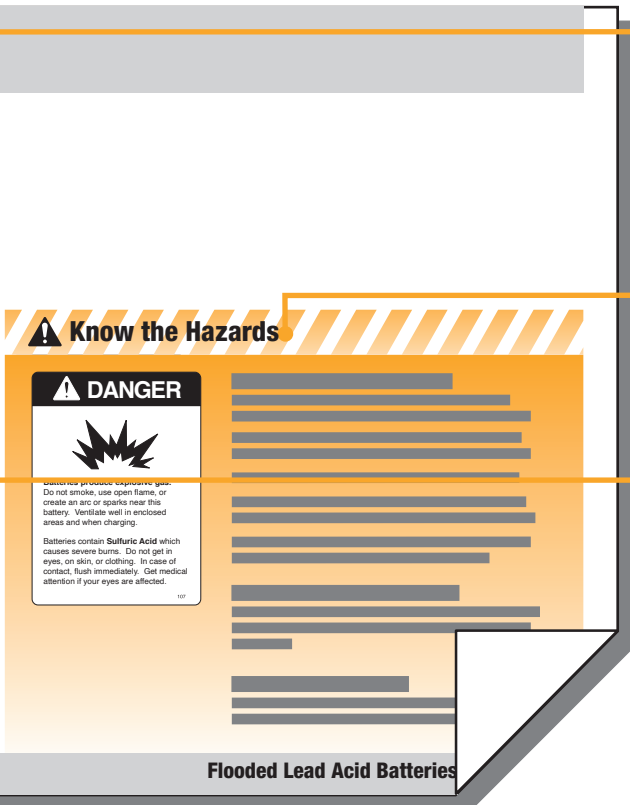

Your Rider Pallet Truck

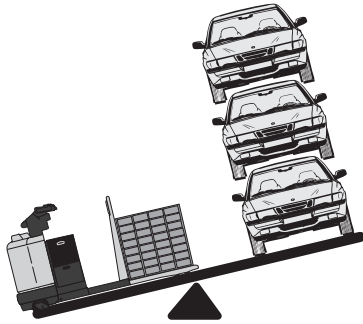

RIDER PALLET TRUCKS

As a rider your pallet truck is designed to move loads over long distances. You can also use it as a walk-beside truck when picking stock.

YOUR PALLET TRUCK IS NOT AN AUTOMOBILE

With a load it may weigh more than 3 automobiles.

- You don't steer the same.
- You don't brake the same.
- You don't accelerate the same.

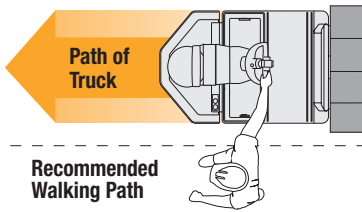

HOW TO DRIVE WHEN WALKING OR COASTING

- Travel power unit first only. Do not turn. Stay to one side of the truck. Use the hand closest to the truck to operate the control handle.
- Watch your feet. Stay out of the path of the truck and load.
- Make certain the area ahead of you is clear.

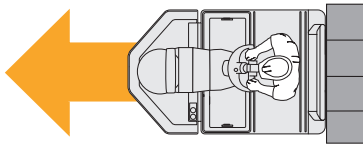

HOW TO DRIVE YOUR TRUCK POWER UNIT FIRST

Keep both feet on the platform. Place both hands on the control handle and lean against the backrest. Keep your entire body within the operator area.

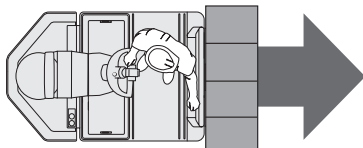

HOW TO DRIVE YOUR TRUCK FORKS FIRST

Keep both feet on the platform. Place one hand on the backrest hand hold and the other on the control handle while leaning against the backrest. Keep your entire body within the operator area.

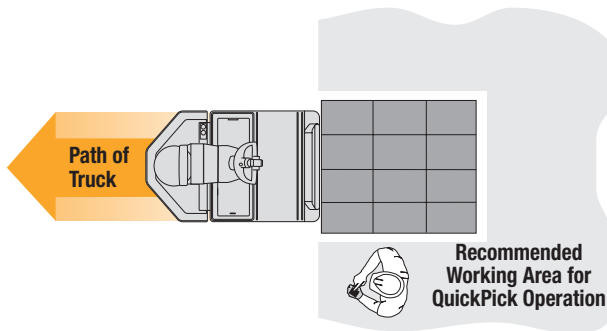

HOW TO DRIVE USING QUICKPICK

- Don't walk in the path of your truck. Stay to the side, or behind the truck and load. Operate within the recommended working area.
- Maintain visual contact with your truck. Make certain the travel path is clear.
- Don't rely on the laser sensors to protect you or others. Stay alert to conditions around you.



GIVE YOUR BODY A BREAK

Take advantage of stop time. Flex your arms and legs. Staying alert will help you be a better and safer driver.

BUILT TO STANDARDS

This truck was designed and built to current industry and government standards and guidelines. For more information see the following:

- American National Standards Institute (ANSI/ITSDF) B56.1 (Download free from www.itsdf.org)
- Occupational Safety and Health Act (OSHA) §1910.178, Rev. 1999 (Download free from osha.gov)
- Underwriters Laboratory (UL 583)
- National Fire Prevention Association (NFPA 505)

Pallet Truck Parts

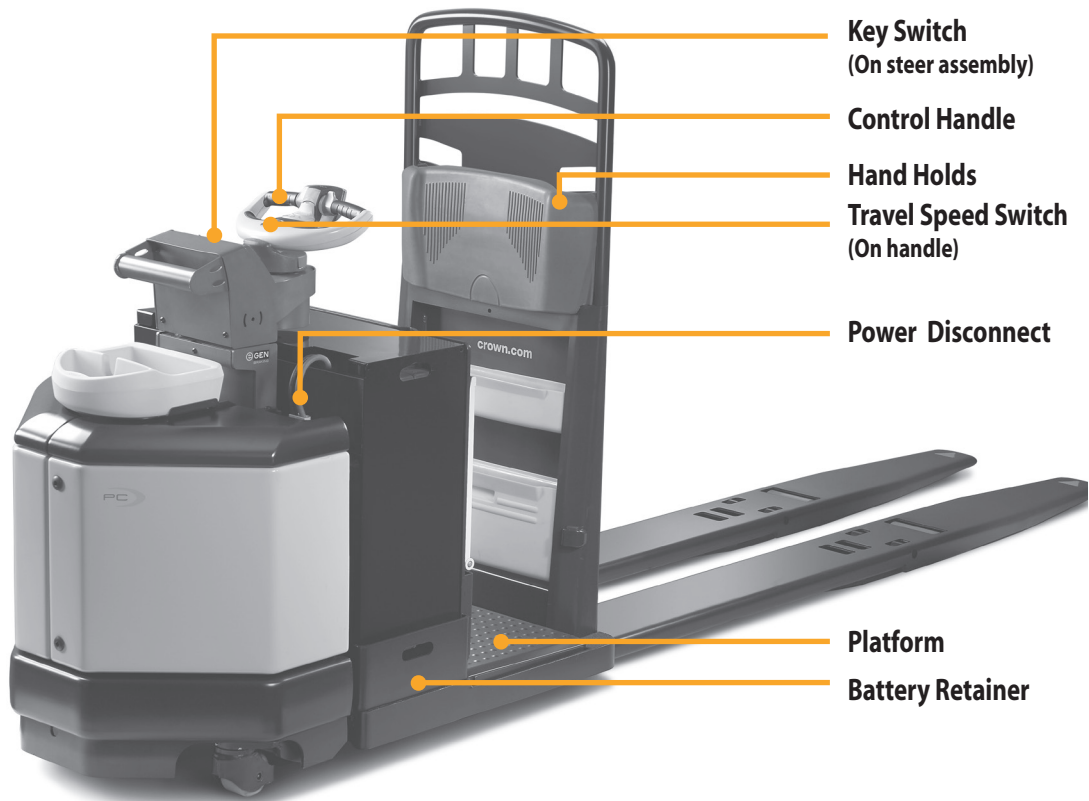

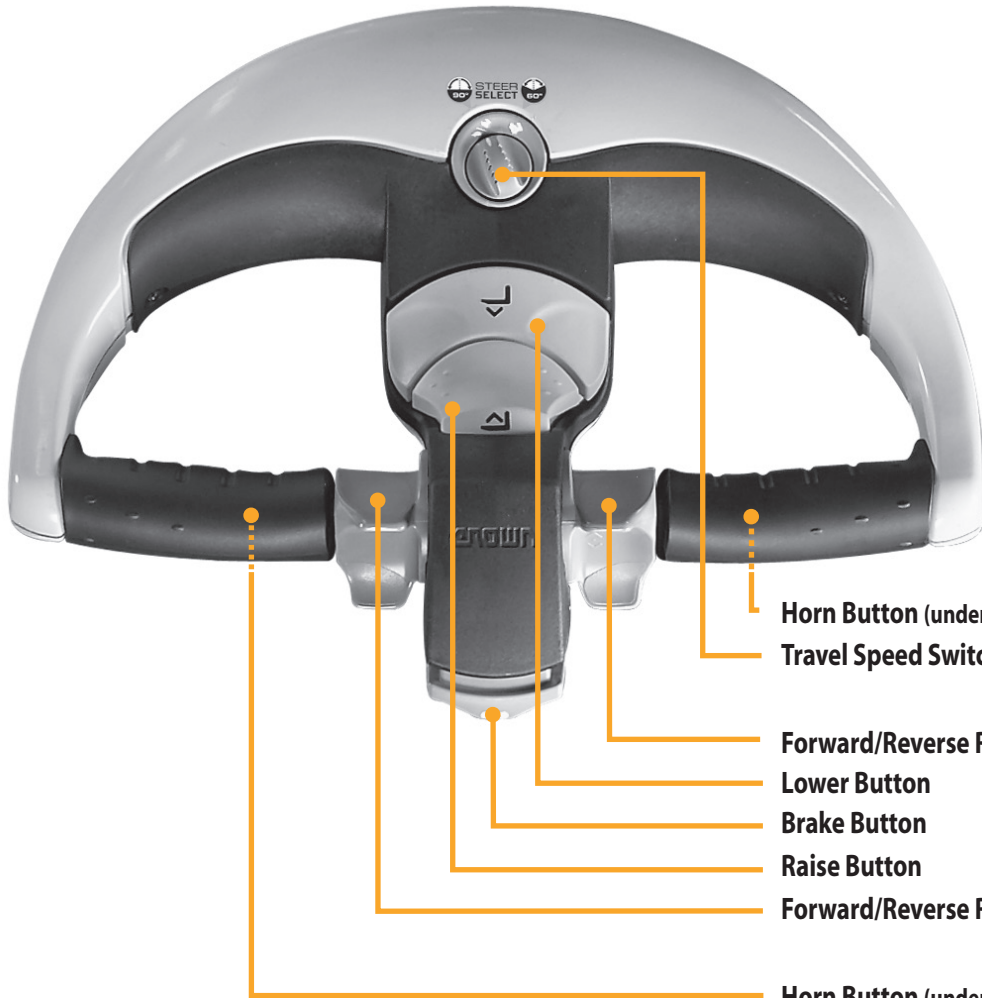

- Horn Button (underside, hidden in view)**
- Travel Speed Switch**
- Forward/Reverse Rockers**
- Lower Button**
- Brake Button**
- Raise Button**
- Forward/Reverse Rockers**
- Horn Button (underside, hidden in view)**

Capacity Plate



CAPACITY PLATE INFORMATION

The capacity plate is on the top of the power unit cover. It contains:

- Capacity information
- Truck type (a fire safety rating)
- Truck weight (does not include load)
- Grade rating
- Battery information
- Truck information

SAMPLE CAPACITY PLATE

The information shown on this sample plate does not apply to your truck.

WHAT IS YOUR TRUCK CAPACITY?

Capacity is the maximum load that can be lifted or transported with your truck. See the capacity plate on your truck. Make certain you use the correct units of measure.

	Units of measure, kg/mm (lb/in)		Truck Data Number	1234567890123456	Max. Pallet/Load Width	1050 (42)		
	Capacity with Equally Distributed Load	2720 (6000)	Total Battery Weight		Hour Rate	6		
	Truck Weight with Max. Battery	1676 (3690)	Min	440 (975)	Max	680 (1500)		
	Truck Weight Less Battery ± 5%	991 (2190)	Model Number	PC4500XX	Max. Grade	5 %	D.C. Voltage	24
	Serial Number	A123456756	Battery Type	E	Load Tire Tread Width	600 (24)	Max. AMP Hr.	600
	Truck Type	E	This truck as released conforms to the mandatory requirements of ANSI/ITSDF B56.1 Crown Equipment Corporation New Bremen, Ohio 45689 USA					



Know the Hazards

KNOW YOUR LOAD

Do not exceed the capacity shown on your truck's capacity plate. Make certain you use the correct units of measure. Be careful when handling long, high or wide loads. Do not handle unstable loads.

MAX. PALLET/LOAD WIDTH

Oversize pallets or loads can present a crush hazard. Do not exceed the maximum pallet/load width specified on the capacity plate or display, depending on truck model.

TRUCK TYPE

Some truck types are not permitted in areas where there are fire hazards. Watch for marked areas. *For example: You must not drive a type E or ES truck into an area restricted to EE or EX trucks.*

TRUCK WEIGHT

Dockboards, elevators and some floors have limited capacity. Check your capacity plate for the weight of your truck. Remember to add the weight of the battery and the load you have on the forks.

Display

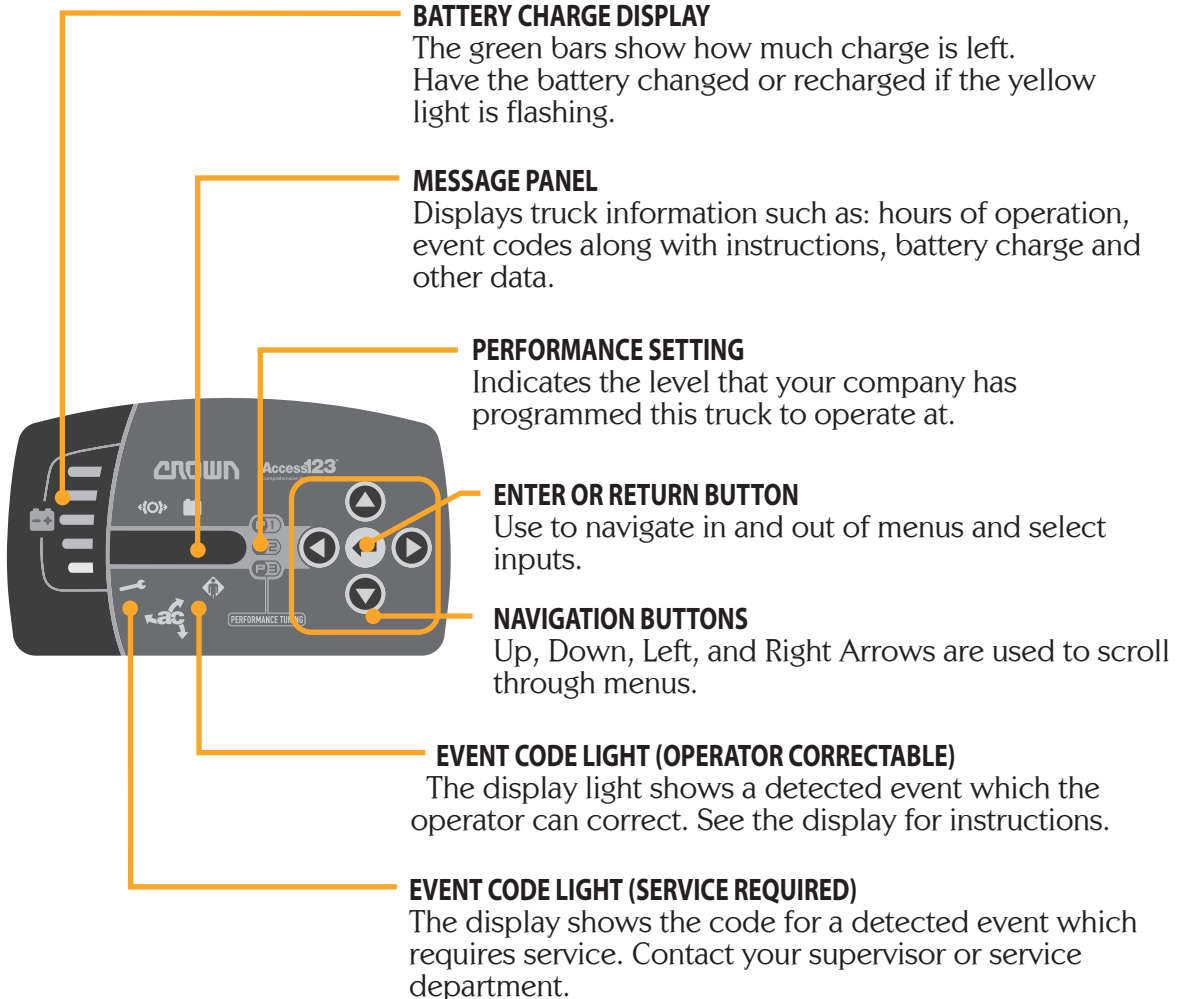

Power On & Off

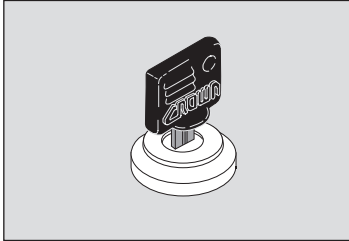

KEY SWITCH

Turn the truck on by turning the key clockwise to ON. Check that all display lights are working.

Turn the truck off by turning the key counterclockwise to OFF.

Always turn the key off when leaving the truck.

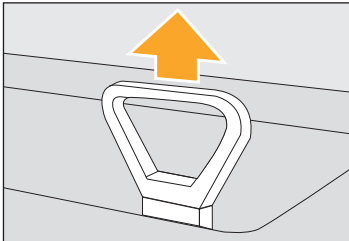

POWER DISCONNECT

Pull up on the battery connector, or the optional handle, to disconnect the battery and cut all power.

Always disconnect the battery any time the truck isn't working correctly. The key switch does not cut all power to the truck.

Don't use the truck if it's not working correctly. Notify your supervisor.

Steering & Travel

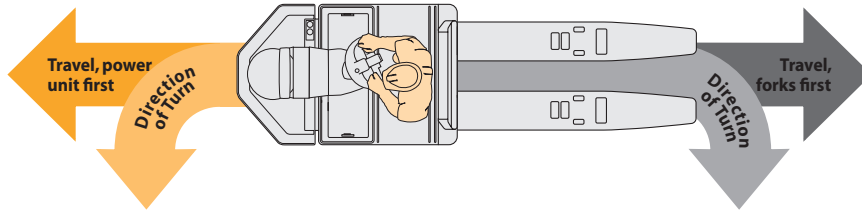

STEERING

You control steering by moving the control handle from side to side. For example: This picture shows the directions the truck can turn when the control handle is moved to the approximate position shown.

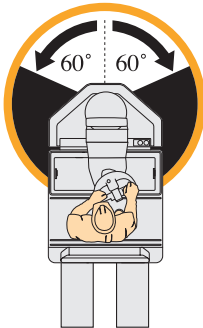

STEERING AT HIGH TRAVEL SPEED

When the travel speed switch is in the high travel speed position (🐣), steering is set to 60° each way of center for smooth operation at higher travel speeds.

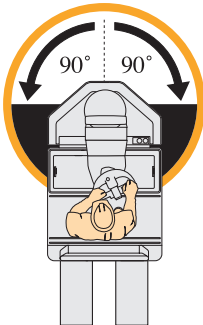

STEERING AT MANEUVER SPEED

When the travel speed switch is in the low travel speed position (🐢), 90° of steering each way of center is available for maneuvering in confined spaces.



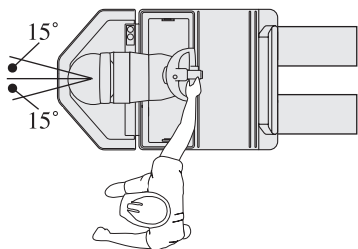

STEERING WHILE WALKING OR COASTING

Anytime the operator is off the platform, steering is reduced to 15° each way of center.



Know the Hazards

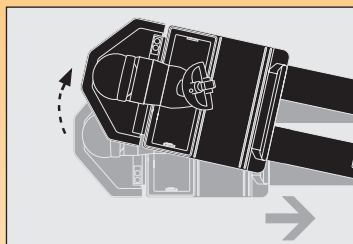

POWER UNIT SWING

Be careful turning while traveling forks first. The power unit will swing wide in the opposite direction. Make sure you have clearance, and watch out for people in the area.

Keep your hands and feet in the operator area.

Warning: Never place objects anywhere on the operator platform. They would be a trip hazard and could affect truck speed and steering.



SLOW DOWN FOR SPILLS OR WET FLOORS

Powder or liquid spills can cause slippery floors. Slow down or you could lose control of steering and braking. Be careful and allow for a longer stopping distance.

Don't run over objects on the floor.

Coasting



COASTING

Coasting can make it easier for you to pick loads while walking to the side of the truck.

The ability to coast is standard. The coasting distance can be adjusted by your service personnel.

When you let go of the forward/ reverse rocker the brake is partially applied to allow the truck to coast to a controlled stop.

However you can apply the brake by pressing the brake button on the control handle.

Be even more careful when allowing the truck to coast. Make sure you understand the possible hazards. Don't place yourself or others at risk.

When moving from the riding position to the walk beside or coast position, stop your truck completely before getting off.

Never get on or off the truck while it is moving.

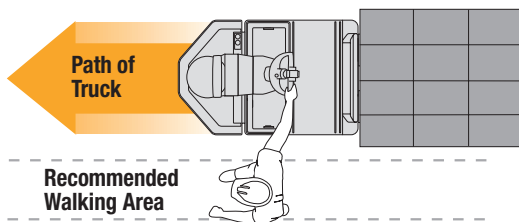

WHEN WALKING OR COASTING

- Travel power unit first only. Do not turn.
- Stay to the side of the truck and load. Keep your arm extended to give maximum clearance between you and the truck or load. Keep your feet clear.
- Make sure the area ahead of you is clear.

Note: When you are off the platform, travel is always in low speed, and steering is reduced to +/- 15 degrees.

WHEN RIDING

Stop your truck completely before getting on or off.

! Know the Hazards



COASTING REQUIRES EVEN MORE CAUTION

- Floors must be level and free of obstacles.
- Never allow the truck to coast into a cross aisle.
- Do not coast in pedestrian walkways.
- Watch out for people and other trucks.
- Do not walk in the path of a coasting truck. Stay to the side of the truck and load. Keep your arm extended and your feet clear.
- When coasting, travel power unit first only. Do not turn.
- Always stop your truck completely before getting on or off.

Braking



BRAKING

To apply the brake, press the brake button on the end of the control handle. The truck will continue to brake to a stop even if the brake button is released.

PARKING BRAKE

The parking brake is automatically applied when the key switch is turned off, the battery is disconnected or after the truck comes to a stop.

The parking brake is released when the Forward/Reverse rocker is moved in the direction of travel.



Know the Hazards



MAKE SURE YOUR BRAKE WORKS

Test the brake on your truck at the start of each shift. Know the distance it takes to stop before you start working.

If at any time the stopping distance is too long for you, do not drive your truck. Notify your supervisor.

SIMILAR LOOKING TRUCKS CAN BE DIFFERENT

Your company has selected the options which are best for your work area.

If you ever drive a different truck, even one that looks just like yours, be careful. It may not have the same controls, functions, or options.

Operation and performance may vary.

Raising & Lowering

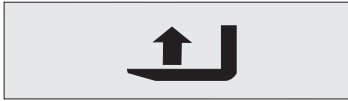

RAISE

Push the RAISE button until the forks are at the desired height.



PRESET LIFT HEIGHT

This feature, when used, allows your company to select the most efficient lift height for your use. Press and hold the RAISE button until the forks stop. To raise beyond that height, release and press the RAISE button again.



LOWER

Push the LOWER button until the forks are at the desired height.

ADDITIONAL RAISE & LOWER BUTTONS, OPTION

You can also control raise & lower from the optional Backrest Control Module.

Don't place your hands or arms over the backrest. They could be pinned or crushed by the load.

Know the Hazards

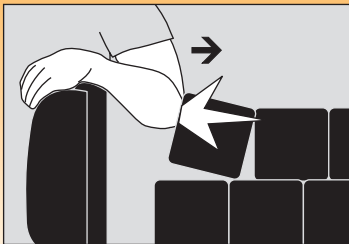

WATCH YOUR HANDS AND ARMS

Your hand or arm could be pinned or crushed between the backrest and a load.

Loads can shift and fall against the backrest.

Keep your hands and arms on the power unit side of the backrest.

Traveling & Plugging

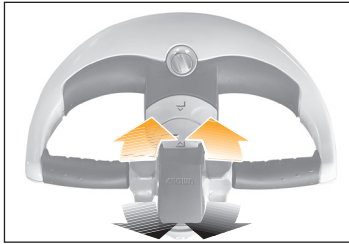

TRAVEL

Move the Forward/Reverse rocker in the direction you want to travel.

The farther you move the rocker from the neutral position, the faster the truck will move.

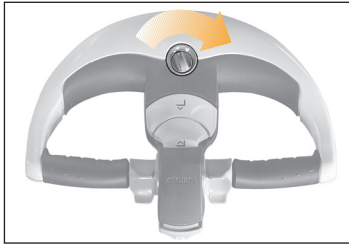

HIGH TRAVEL SPEED

For high travel speed, turn the travel speed switch to the high speed position (→), and move the Forward/Reverse rocker to the maximum travel speed position.

Steering performance is set at 60° each way of center for smooth operation at higher speeds.

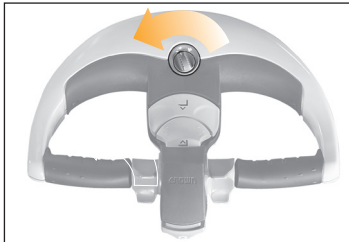

MANEUVERING SPEED

For maneuvering and traveling in congested areas, turn the travel speed switch to the low speed position (←).

The display message panel will show **MANEUVER**. 90° of steering each way of center is available for maneuvering in confined areas.

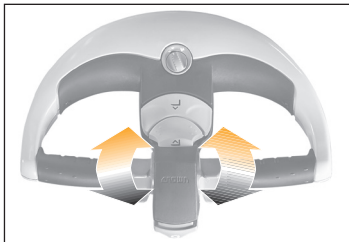

PLUGGING

Plugging is another way to slow down your truck. While the truck is moving, in either direction, move either Forward/Reverse rocker through neutral to the opposite direction of travel.

Plugging will not hurt your truck.

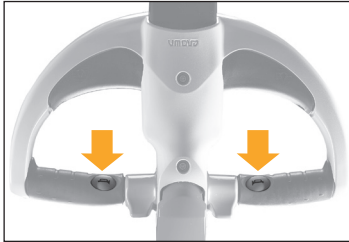

HORN

Push the switch on the underside of either grip to sound the horn. Use it to warn pedestrians and other drivers.

Use your horn when you come to an intersection or a crosswalk.

! Know the Hazards



WATCH YOUR FEET AND HANDS

- While riding, keep your feet on the platform and hands on the controls at all times. This truck weighs over 4535kg (10,000 lbs.) You can not stop or even slow it down with your foot, hand or any part of your body, no matter how slow the truck is moving.



LOOK WHERE YOU'RE GOING

- Don't use cell phones or similar devices while operating the truck.
- Travel in the direction where you have the best visibility.
- Always be alert to the area around you and watch where you are driving.
- Any part of your body caught between the truck or load, and any fixed object, can be crushed.
- You could also be seriously injured by objects intruding or poking into the operator area.
- Don't put hands or arms over or through the backrest.

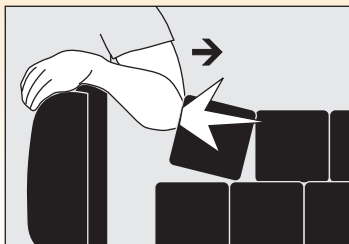

BRAKING VS. PLUGGING

Of the two, braking is designed to stop the truck in the shortest distance. Use braking in an emergency, on ramps or in busy areas.

QuickPick®

QUICKPICK®

This optional feature allows you to control travel and braking with a wireless remote or Ring. QuickPick is only active when you are off the platform.



At the start of a shift, snap a charged remote into the glove and pair with the truck.

PAIRING THE REMOTE

1. Enter a valid ID number through the Access display keypad or InfoLink module.
2. Display shows the last paired remote
 - If the ID number displayed matches, enter “yes”
 - Enter “no” to pair a different remote
3. Follow display prompts
 - Press Brake and Horn buttons simultaneously and then release
 - Press the Go button and then release

Note: Pair the remote to the truck at initial power up. If the user code times out, you will need to pair the remote.

CHARGING THE REMOTE

Snap the wireless remote into the charger. Lights on the charger will indicate charge status.



On-Truck Charger



Fast-Charge Ring

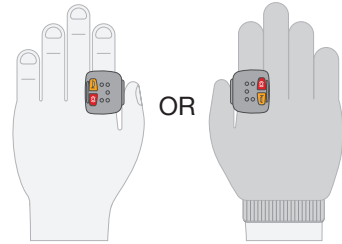

PAIRING THE FAST-CHARGE RING

1. Insert the Ring into the On-Truck Charger.
Keep the Ring connected to the On-Truck Charger until all 5 green lights appear.
2. Press and release the Go Button when the green lights begin to pulse.
3. Press and release the Brake and Horn buttons.

QuickPick is active when the lights are solid green.

Note: Recharge the Ring whenever the On-Truck Charger lights are amber.

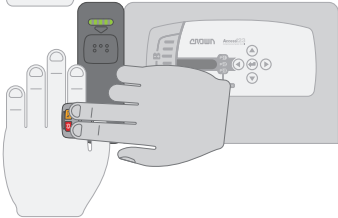
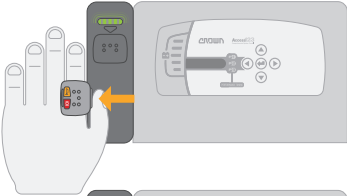

REPLACING THE STRAP

To remove the old strap, pull out the end cap.

To install a new strap

1. Insert a new strap and pull it until the end cap is a flush with the ring.
2. Insert the strap through the slot below the Go Button.

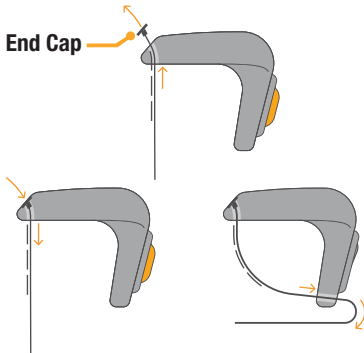

QuickPick® continued

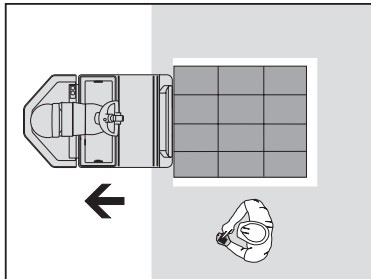

**Recommended Working Area
for QuickPick Operation**

HOW TO USE

Align the truck in the aisle and always check that the aisle ahead is clear before pressing the Go Button.

- Keep your feet clear and don't walk in the path of your truck. Stay to the side, or behind the truck and load. Your feet and legs can be seriously injured.
- Operate within the recommended working area.

Go Button (active when the operator is off the platform)

Double press and hold the Go Button and the truck will travel power unit first (an alert will sound and the strobe lights will flash). You may let go then simply press again to extend travel.

Release the Go Button and the brake is partially applied to allow the truck to coast to a controlled stop.

Horn Button

Press to sound the horn.

Brake Button

Press to stop the truck.



Know the Hazards



REMOTE OPERATION REQUIRES EVEN MORE CAUTION.

You must be constantly aware of everything around the truck, which includes the pallet and load, rack conditions and pedestrian safety, along with your own safety.

USE YOUR TRUCK SAFELY

- Don't rely on the laser sensors to protect you or others, always stay alert to conditions around you.
- Don't use the remote in congested areas or intersections.
- Don't walk in the path of your truck. Stay to the side, or behind the truck and load.
- Never ride on any part of the truck other than the operator platform.

CARE AND CLEANING

- Keep the Ring at room temperature. Avoid excessive heat.
- Only wipe clean the Ring. Do not submerge or soak.
- Only wipe clean the On-Truck Charger. Do not pressure wash.
- Do not store objects near the On-Truck Charger.

Know the Hazards

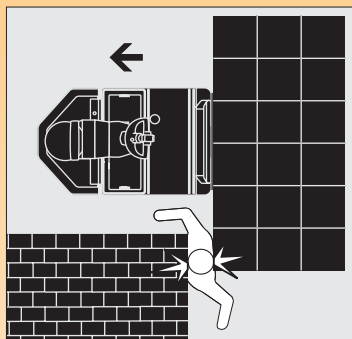

PALLET/LOAD WIDTH

Do not exceed the maximum pallet/load width specified on the capacity plate or display, depending on truck model.

Oversize pallets or loads can present a crush hazard. If an oversize load must be moved, don't use the remote control. Operate the truck from the platform. Have a second person, or "spotter", assist in checking clearances, watching for obstructions and keeping personnel away.

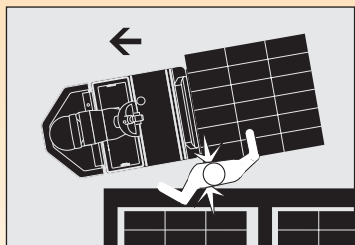

USE YOUR TRUCK SAFELY

- Floors must be level and free of objects.
- Maintain visual contact and stay within 7.6 meters (25 feet) of your truck while using QuickPick. Make certain the travel path is clear.
- Don't get on or off the truck while it is moving.
- Be safe, protect others. Always turn the key off or disconnect the battery when you leave the truck.
- Keep others away from your truck.

QuickPick® continued

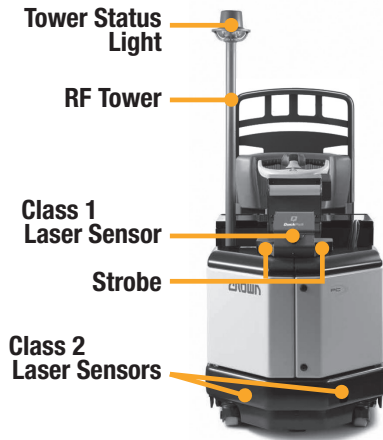

LASER OPERATION

When active, the laser sensors are designed to stop the truck if stationary objects are detected in the travel path. The lasers are not active when standing on the platform or using the forward/reverse rockers on the control handle. **Be alert to the area around you and don't rely on the laser sensors to protect yourself and others.** The green light on the tower shows laser status.

TOWER STATUS LIGHT

- **Light off:** operation and lasers are not active.
- **Light on:** operation is ready to use and lasers are active.
- **Light flashing slow:** is out of range or event is detected.
- **Light flashing fast:** an object has been detected.

Know the Hazards



RACK CONFIGURATION

The laser sensors are designed to work with racks that have vertical front uprights. If uprights are slanted at the bottom, or if the rack overhangs into the aisle, do not operate the truck in that aisle.

Check with your supervisor for approval to use this truck in your work area.



8025

LASER SAFETY

There are 4 classes of lasers, depending on power. This option uses low powered class 1 and class 2 laser sensors for object detection. Protect your eyes. Avoid direct eye exposure to the laser light.

DAILY SAFETY CHECK

When performing daily safety check, (pages 32 & 33):

- Before turning on the truck, make certain there is no visual damage to any of the laser sensors, and they are clean and free of debris.
- Be sure strobes and status light are working.
- Check the Brake, Horn, and Go buttons.
- Check alignment of skirt mounted laser sensors.
(See below)

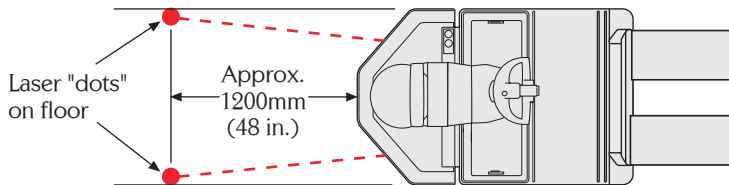

FCC STATEMENT

CAUTION: Changes or modifications not expressly approved could void your authority to use this equipment.

This device complies with Part 15 of the FCC Rules. Operation is subject to the following two conditions: (1) This device may not cause harmful interference and (2) this device must accept any interference received, including interference that may cause undesired operation.

FCC COMPLIANCE

This remote control device has been tested and found to comply with the limits for a Class A digital device, pursuant to Part 15 of the FCC Rules. These limits are designed to provide reasonable protection against harmful interference when the equipment is operated in a commercial environment. This equipment generates, uses, and can radiate radio frequency energy, and if not installed in accordance with the instruction manual, it may cause harmful interference to radio communications. Operation of this equipment in a residential area is likely to cause harmful interference, in which case the user will be required to correct the interference at his own expense.

Any modification made to this device that is not approved by Crown Equipment Corporation may void the authority granted to the user by the FCC to operate this equipment.

ISED STATEMENT

This device complies with Industry Canada license-exempt RSS standard(s). Operation is subject to the following two conditions: (1) this device may not cause interference, and (2) this device must accept any interference, including interference that may cause undesired operation of the device.

Le présent appareil est conforme aux CNR d'Industrie Canada applicables aux appareils radio exempts de licence. L'exploitation est autorisée aux deux conditions suivantes : (1) l'appareil ne doit pas produire de brouillage, et (2) l'utilisateur de l'appareil doit accepter tout brouillage radioélectrique subi, même si le brouillage est susceptible d'en compromettre le fonctionnement.

QuickPick® continued

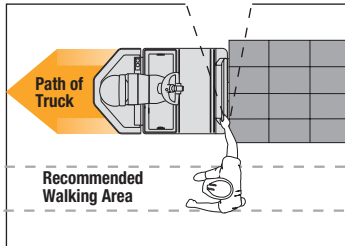
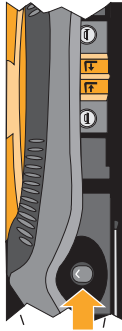
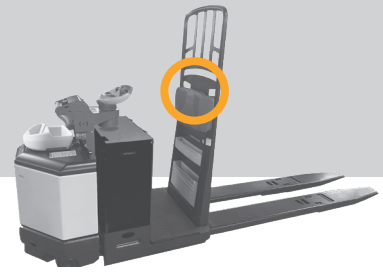

QUICKPICK POSITION CONTROL

This optional feature can make it easier to pick items close together in an aisle.

Press the Position Control button on either side of the backrest to travel power unit first.

- Stay to the side of the truck and load.
Keep your arm extended to give maximum clearance between you and the truck or load. Keep your feet clear.
- Make sure the area ahead of you is clear.

Additional Options

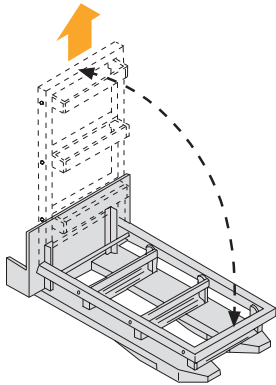

SKID ADAPTOR OPTION

Lift the skid adaptor until you can move it forward and lower it to the forks.

Make certain the skid adaptor is secure when you return it to the upright position.



SECOND LEVEL STEP

For assistance reaching higher levels, swing the optional step down to the level position.

When either step is in the down position, the brake is applied and you cannot travel.



Know the Hazards

SIMILAR LOOKING TRUCKS CAN BE DIFFERENT

Your company has selected the options which are best for your work area.

If you ever drive a different truck, even one that looks just like yours, be careful. It may not have the same control handle, functions, or other options.

Operation and performance may vary.

Daily Safety Check



CHECK YOUR TRUCK BEFORE STARTING WORK

You must make sure your truck is safe to use.

1. Walk around your truck and check it over.

- Check to make sure the battery is charged.
- Check the battery connector, battery terminals, and battery cables for damage.

For flooded lead acid batteries:

- Check the battery compartment for spilled acid.
- After checking the water level, make sure that the vent caps are in place.
- Make certain the battery retainers on both sides of the truck are properly installed.
- See that all wheels are in good condition.
- Clean the control handle and hand holds.
- Make certain there are no objects placed anywhere on the operator platform.
- Check that forks are not bent, cracked or badly worn.
- Look under the truck for signs of hydraulic leaks.
- Try the horn.
- Make sure the power disconnect works.
- Check that all controls work smoothly.

2. Test drive your truck in an uncongested area.

- Try all the hydraulic functions.
- To check power steering: Turn the truck on. Step onto the platform. Steering should be difficult for a second and then become easier.
- Drive the truck slowly in both directions.
- Check braking distance in both directions. Load size and floor conditions can affect these distances.
- Drive through the full speed range in both directions.
- Know the distance it takes to stop before you start working. If the braking distance is too long for you, do not drive your truck.
- Check parking brake operation.

If anything does not look, work, feel, or sound right, do not operate your tuck. Notify your supervisor.

You can get checklist forms from your Crown dealer (part no. OF3772). Used properly, this checklist can alert service people to needed repairs.

Be a Safe Driver



The most
important
component
is you.



MAKE SURE YOU ARE READY TO DRIVE

- Do not use this truck unless you are trained and certified.
- Be certain you understand how your truck works and the hazards that go with it. Don't drive the truck if you have any doubts.
- Know the capacity of your truck. Make certain you use the correct units of measure.
- Some trucks are not allowed in areas where there are fire hazards. Be certain your truck is the correct fire safety type for the area.
- Make sure your hands and shoes are clean and dry, and your clothing is proper for the job.

MAKE SURE YOUR TRUCK IS READY

- Inspect your truck before using it (see pages 32 and 33). If it's not working correctly, or something is broken, notify your supervisor. Don't use the truck.
- In an open area, test the braking. Check at a slow travel speed first, then a faster one. Know the distance it takes to stop before you start work.
- Make certain there are no objects stored anywhere on the operator platform. They would be a trip hazard and could affect truck speed and steering.

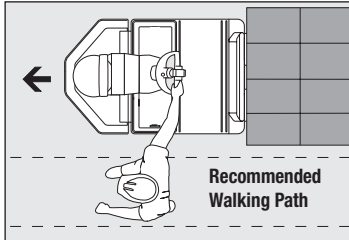

WHEN COASTING

- Travel power unit first only. Do not turn.
- Stay to the side of the truck and load. Keep your feet clear.
- Be certain the area ahead of you is clear.

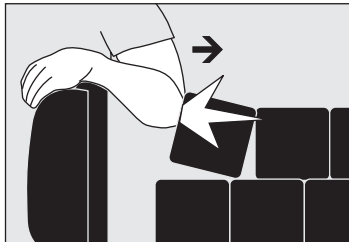

WHEN RIDING

- Never stick a foot or any part of your body outside the operator area, no matter how slow the truck is moving.
- Don't put your hands or arms over the backrest. Keep your hands on the controls and feet on the platform.
- Never ride on any part of the truck other than the operator platform.
- Stop your truck before getting on or off.



DRIVE CAUTIOUSLY, BE ALERT

- Look where you are going. Don't let any part of your body get pinned or crushed. Don't get caught between the truck, or load, and a fixed object.
- Travel in the direction that gives you the best view. Slow down in congested areas.
- Slow down for wet or slippery floors. Don't run over objects. Watch out for rough floors.
- Look where you are going before you change direction of travel.
- Avoid sudden movement of controls. Learn to use them smoothly at a moderate, even rate.
- Be extra careful if you must use your truck in an area where there is a risk of falling objects.

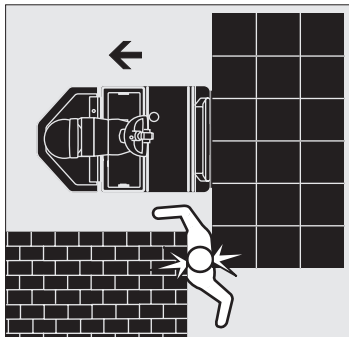

Continued next page...

Be a Safe Driver continued



WATCH OUT FOR OTHER PEOPLE

- Slow down. Yield or stop for pedestrians. Use your horn when you come to a crosswalk or intersection.
- Be careful that you don't pin or crush someone. *For example: Never drive your truck toward anyone standing in front of a fixed object*
- Be even more careful moving a wide load. Make certain you or someone around you doesn't get pinned or crushed. Have a helper or "spotter" assist you.
- Keep others away from your truck while you're working. Don't ever ride or allow anyone to ride on the load or forks.
- Don't let anyone use your truck unless they are trained and certified.
- Don't allow the truck to coast in a congested area or if there are people in the aisle.
- Watch out for power unit swing. Slow down when making turns.
- Never allow passengers on your truck.

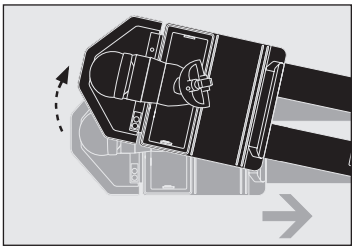
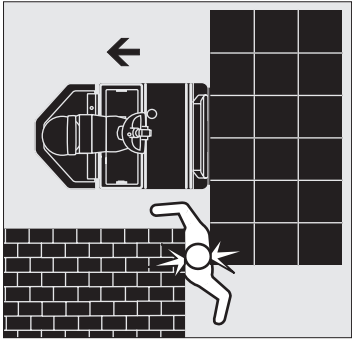

WHEN LEAVING YOUR TRUCK

- Lower the forks. Turn the truck off or disconnect the battery.
- Come to a complete stop before leaving truck.
- Avoid parking on inclines. If you must park on an incline, chock the wheels to prevent the truck from moving.

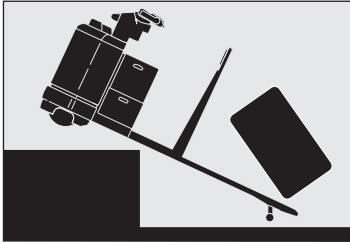

AVOID FALLS

- Stay away from the edge of docks and ramps.
- Check that bridgeplates and dockboards are secure. Be certain that either the trailer wheels are chocked or the trailer is locked to the dock. Check capacities. Be sure your truck, with load, isn't too heavy for where you are driving.
- Properly install jack stands under the front of the trailer when a tractor is not attached.
- Make sure the load you are moving is stable. Center the load. Be even more careful with long, high or wide loads. They can be less stable.
- Don't drive onto an elevator unless you are authorized. Check the capacity or load limit and make sure there are no people present. Enter load first and come to a complete stop.

BE CAREFUL TRAVELING ON RAMPS AND GRADES

- Always operate your truck from the rider position when traveling on a grade.
- With a load, drive with the forks pointed upgrade.
- Without a load, drive with forks downgrade.

Slow down and don't turn on ramps or grades.

Power Sources

POWER SOURCES

Your truck can be designed to use the following power sources:

- Flooded Lead Acid Batteries
- Thin Plate Pure Lead Acid Batteries
- Lithium-Ion Batteries
- Fuel Cell Power Packs

If your truck is equipped with a V-Force lithium-ion battery, see the data plate installed on your truck.

Only Crown approved power sources are permitted to be used in your truck. Only authorized service personnel are permitted to modify the power source installed in your truck.

See the power source data plate for the approved power source installed in your truck.

Note: Follow the manufacturer's specification and instructions when handling power sources.

WORKING WITH POWER SOURCES

Your company should provide an area that is safe to work on power sources. Use that area for all power source work and charging.

- Do not charge or refuel a power source unless you are trained and authorized.
- Do not remove or install a power source unless you are trained and authorized.

Charging Power Sources

BEFORE CHARGING POWER SOURCES

- Read the instructions for the charger and power source.
- Make sure that the charger has the correct voltage and amperage for the power source.
- Only charge a power source in an authorized area.

CHARGING A FLOODED LEAD ACID BATTERY

1. Turn off your truck.
2. Unplug the power source connector from the truck.
3. Follow the charging instructions from the power source manufacturer.

When charging is complete, unplug the charger and plug the power source connector into the truck.

CHARGING A V-FORCE™ LITHIUM-ION BATTERY

1. Turn off your truck.
2. Plug the charger into the battery charge port.
3. Follow the charging instructions for the V-Force lithium-ion battery.

Opportunity charge during breaks or whenever the truck is not being used.

When opportunity charging is complete or the battery is fully charged, unplug the charger from the battery charge port.



Know the Hazards

AVOID DAMAGING THE TRUCK AND BATTERY CHARGER

Make sure that the battery charger is plugged into the battery connector, not the truck connector.

AVOID DAMAGING THE BATTERY

Batteries that are not properly maintained will fail prematurely.

Always follow the battery manufacturer's instructions.

Lithium-ion & Fuel Cell Power Packs

LITHIUM-ION BATTERIES AND FUEL CELL POWER PACKS

For trucks equipped with a V-Force lithium-ion battery, the energy status is shown on the truck display.

Trucks qualified and approved to operate with another lithium-ion battery or fuel cell power pack can have a separate display. Use the display installed on the battery to see the energy status.



Know the Hazards

AVOID DAMAGING THE POWER SOURCE

Do not operate trucks with lithium-ion batteries in freezing temperatures. Do not leave trucks in freezing temperatures.

Always follow the battery manufacturer's instructions.

This page left
blank
intentionally

Flooded Lead Acid Batteries

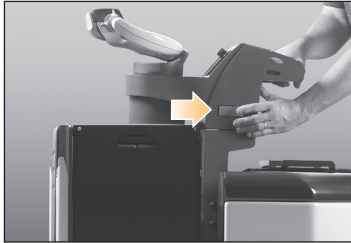

WHEN YOU INSTALL OR CHANGE BATTERIES

- Turn the truck OFF. Brake applies automatically when truck is turned OFF. Check that all controls are in neutral and disconnect the battery. Press the button on the side of the steer column and pivot the handle out of the way before removing the battery.
- Make certain you use the correct size and weight battery. Never operate a truck that has an underweight or undersize battery installed.
- Never let anything metal touch the top of the cells. You could cause sparks or do damage to the battery. Use an insulator (such as plywood) when necessary.
- Use an approved spreader bar to place a battery in, or remove it from, the battery compartment or a stand. Make sure you adjust the spreader bar hooks to fit the battery. Lift and move the battery carefully.

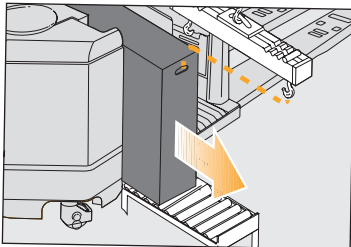

USING A ROLLER STAND

If you use a roller stand to install or remove a battery make sure the roller stand is the same height as the rollers in the truck's battery compartment. Also make sure the roller stand is at least as long as your battery.

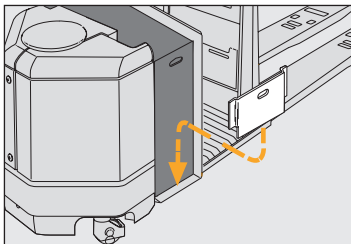

AFTER INSTALLING YOUR BATTERY

- Replace the battery retainers. Make certain the retainers on both sides of the truck are in place.
- Connect the battery. Turn the truck ON and check truck operation.

Know the Hazards

 **DANGER**



Batteries produce explosive gas.
Do not smoke, use open flame, or create an arc or sparks near this battery. Ventilate well in enclosed areas and when charging.

Batteries contain **Sulfuric Acid** which causes severe burns. Do not get in eyes, on skin, or clothing. In case of contact, flush immediately. Get medical attention if your eyes are affected.

107

TRUCK BATTERIES CAN BE DANGEROUS

Lead acid batteries produces gas that can explode. They also contain acid that could burn or disfigure you.

- Do not try to install, remove, charge or service your truck battery unless you are trained and authorized.
- Never smoke or use an open flame around batteries.
- Your company should provide an area where it is safe to work on batteries. Use that area for all battery work.
- Use protective equipment such as gloves, eye shields, aprons etc.

BATTERY RETAINERS MUST BE IN PLACE

The battery could slide out if retainers are not in place. Check that both retainers are installed before operating your truck.

Continued next page...

Flooded Lead Acid Batteries

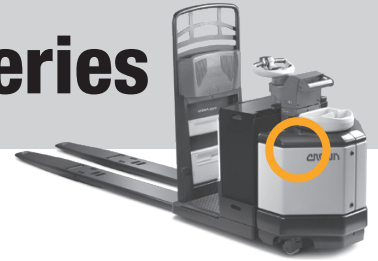

Know the Hazards



BEFORE CHARGING YOUR TRUCK BATTERY

- Charge the battery only in areas designated for that use.
- Make sure the truck key switch is turned off and all other controls are in the off or neutral position.
- See that the battery cells are filled to the proper level.
Never use an open flame to check the battery.
- Make certain the charger is the same voltage and amperage as your battery.
- Read the battery charger instructions.
- Be sure the charger is turned OFF before connecting the battery to the charger. Otherwise you might create a spark which could cause the battery to explode.

WARNING

Minimum battery size allowed
000 mm (00.00 in.) wide
000 mm (00.00 in.) long

Undersize battery can affect truck handling and stability. You could have an accident.

Use U.L. classified Type E battery.

BATTERY SIZE IS IMPORTANT

Make certain you use the correct size, type and weight of battery. Never operate a truck that has an underweight or undersize battery installed.

This page left
blank
intentionally

Warning Labels

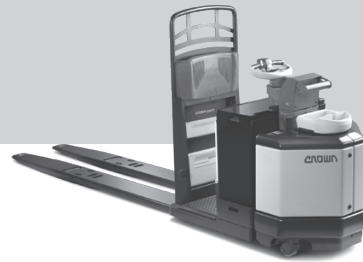

EACH WARNING LABEL ON YOUR TRUCK IS IMPORTANT

Read and obey all of them to protect yourself and others.

WARNING

Minimum battery size allowed
xxx mm (xx.xx in.) wide
xxx mm (xx.xx in.) long

Undersize battery can affect truck handling and stability. You could have an accident.
Use U.L. classified Type E battery.

DANGER

Batteries produce explosive gas. Do not smoke, use open flame, or create an arc or sparks near this battery. Ventilate well in enclosed areas and when charging.

Batteries contain **Sulfuric Acid** which causes severe burns. Do not get in eyes, on skin, or clothing. In case of contact, flush immediately. Get medical attention if your eyes are affected.

WARNING

Standing or riding on the forks or pallet can cause a fall. You can be seriously injured or killed.

Never stand or ride on the forks or pallet for any reason.

WARNING

When using QuickPick™, stay to the side or behind the truck and load. Your feet can be seriously injured.

Stay in the recommended working area.

WARNING

STOP **It's the law, you must be trained and certified to operate this truck.** (OSHA § 1910.178, Rev. 1999)

You or people around you could be seriously injured or even killed if you don't use this truck correctly. Obey all warnings and instructions on the truck and in the operator manual*.

Inspect your truck before starting work, make sure it is in good working order.

Avoid being crushed. Keep head, arms, hands, legs, and feet within the operator area. **Stop truck completely before getting on or off.**

Tipovers and falls from docks can cause serious injury or even death. **Use extreme caution near docks or on dockplates.**

You could be pinned or crushed by fixed objects, or by objects intruding or poking into the operator area. **Always be alert to the area around you and watch where you are driving.**

Oversize pallets or loads can be a crush hazard. **Do not exceed the maximum pallet/load width shown on either the capacity plate or display, depending on truck model.**

*Additional copies of the Operators Manual and Truck Labels can be obtained from Crown Equipment Corp., New Bremen, OH 45869 USA.

WARNING

Standing or riding on the forks or pallet can cause a fall. You can be seriously injured or killed.

Never stand or ride on forks or pallet for any reason.

WARNING

Operate this truck only with an approved electric power source.

This truck as designed and manufactured from the factory is qualified for use with a lead acid battery and if configured, Crown V-Force products.

Written approval must be obtained from Crown prior to installation of a new type of electric power source. OSHA 1910.178 (a).

WARNING

Servicing can cause unexpected movement of the steering linkage and drive units. Hands or arms could be pinned or crushed. **Keep hands out when batteries are plugged in. Disconnect batteries before servicing.**

WARNING

Objects placed on the operator platform could affect truck operation, or cause you to trip and be injured. **Keep operator platform clear.**

WARNING

Moving parts can cut or crush hands, feet, arms or legs.

WARNING

Stay clear of all moving parts.

Moving parts can cut or crush hands, feet, arms or legs.

CAUTION

Connect charger properly or truck can be damaged. Make certain charger is plugged into the battery connector, not the truck connector.

CAUTION

Class 2 LASERS
Do not stare directly into laser beam.

All rights reserved under International and Pan American copyright conventions
Copyright 2008 - 2021 Crown Equipment Corp.



4500 SERIES

*This operator manual
has information for
all models of series
PC 4500 plus some
options and accessories.
Some of the illustrations
and information may
not apply to your truck.*



The most important component is you.



New Bremen, Ohio 45869 USA

© 2008-2021

PF14949 Rev. E

Printed in U.S.A.